



MMBTSC3875

NPN Transistor

Features

- For Switching and AF Amplifier Applications.
- As Complementary Type of the PNP Transistor
MMBTSA1504 is Recommended.

SOT-23
(TO-236)

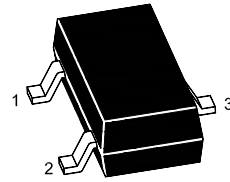

1.Base 2.Emitter 3.Collector

Marking:

MMBTSC3875O:ALO

MMBTSC3875Y:ALY

MMBTSC3875G:ALG

MMBTSC3875L:ALL

Absolute Maximum Ratings

Ratings at 25°C ambient temperature unless otherwise specified.

Parameter	Symbol	Value	Unit
Collector Base Voltage	V_{CBO}	60	V
Collector Emitter Voltage	V_{CEO}	50	V
Emitter Base Voltage	V_{EBO}	5	V
Collector Current	I_C	150	mA
Power Dissipation	P_D	150	mW
Junction Temperature	T_J	150	°C
Storage Temperature Range	T_{STG}	-55 to 150	°C



Electrical Characteristics

Ratings at 25°C ambient temperature unless otherwise specified.

Parameter	Symbol	Min.	Typ.	Max.	Unit
DC Current Gain at $V_{CE} = 6\text{ V}$, $I_C = 2\text{ mA}$ Current Gain Group	O Y G L H_{FE}	70	-	140	
		120	-	240	
		200	-	400	
		350	-	700	
Collector Base Cutoff Current at $V_{CB} = 60\text{ V}$	I_{CBO}	-	-	100	nA
Emitter Base Cutoff Current at $V_{EB} = 5\text{ V}$	I_{EBO}	-	-	100	nA
Collector Base Breakdown Voltage at $I_C = 100\text{ }\mu\text{A}$	$V_{(BR)CBO}$	60	-	-	V
Collector Emitter Breakdown Voltage at $I_C = 1\text{ mA}$	$V_{(BR)CEO}$	50	-	-	V
Emitter Base Breakdown Voltage at $I_E = 100\text{ }\mu\text{A}$	$V_{(BR)EBO}$	5	-	-	V
Collector Emitter Saturation Voltage at $I_C = 100\text{ mA}$, $I_B = 10\text{ mA}$	$V_{CE(sat)}$	-	0.1	0.25	V
Base Emitter Saturation Voltage at $I_C = 100\text{ mA}$, $I_B = 10\text{ mA}$	$V_{BE(sat)}$	-	-	1	V
Transition Frequency at $V_{CE} = 10\text{ V}$, $I_C = 1\text{ mA}$	f_T	80	-	-	MHz
Collector Base Capacitance at $V_{CB} = 10\text{ V}$, $f = 1\text{ MHz}$	C_{ob}	-	-	3.5	pF



Electrical Characteristics Curves

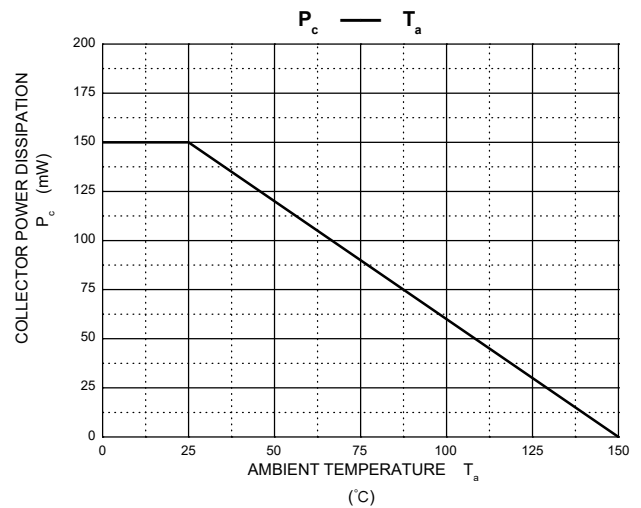
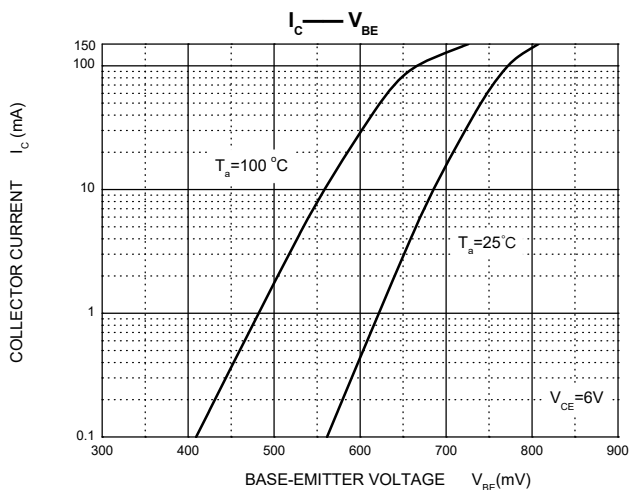
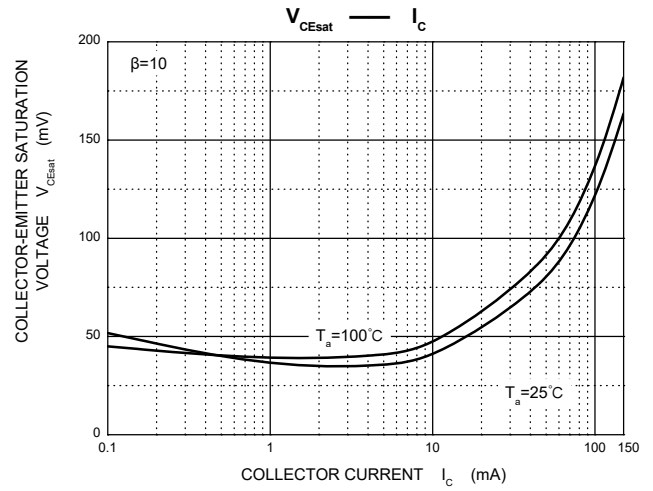
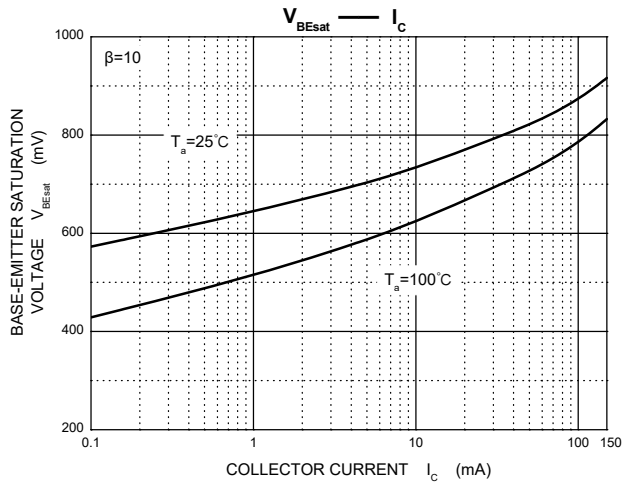
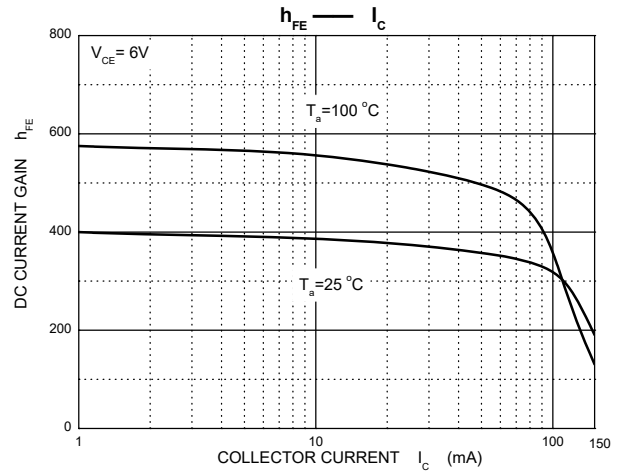
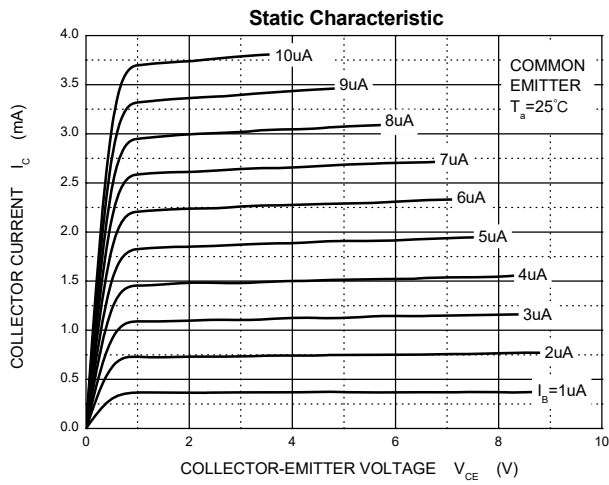



Package Outline(SOT-23)

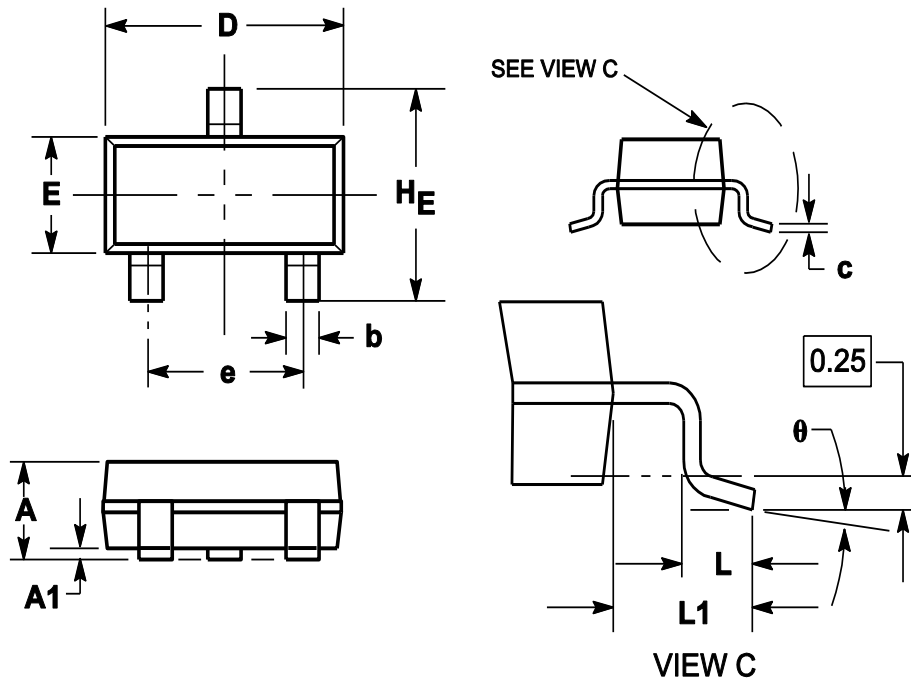

Symbol	Dimensions in millimeter		
	Min.	Typ.	Max.
A	0.900	1.025	1.150
A1	0.000	0.050	0.100
b	0.300	0.400	0.500
c	0.080	0.115	0.150
D	2.800	2.900	3.000
E	1.200	1.300	1.400
HE	2.250	2.400	2.550
e	1.800	1.900	2.000
L1	0.550REF		
L	0.300		0.500
θ	0°		8°

Ordering Information

Device	Package	Reel Dimension (inch)	Shipping
MMBTSC3875	SOT-23	7	3,000

X-ON Electronics

Largest Supplier of Electrical and Electronic Components

Click to view similar products for [Bipolar Transistors - BJT category](#):

Click to view products by [Pingjingsemi manufacturer](#):

Other Similar products are found below :

[619691C](#) [MCH4017-TL-H](#) [MJ15024/WS](#) [MJ15025/WS](#) [BC546/116](#) [BC556/FSC](#) [BC557/116](#) [BSW67A](#) [HN7G01FU-A\(T5L,F,T](#)
[NJVMJD148T4G](#) [NSVMMBT6520LT1G](#) [NTE187A](#) [NTE195A](#) [NTE2302](#) [NTE2330](#) [NTE2353](#) [NTE316](#) [IMX9T110](#) [NTE63](#) [NTE65](#)
[C4460](#) [SBC846BLT3G](#) [2SA1419T-TD-H](#) [2SA1721-O\(TE85L,F\)](#) [2SA1727TLP](#) [2SA2126-E](#) [2SB1202T-TL-E](#) [2SB1204S-TL-E](#) [2SC5488A-](#)
[TL-H](#) [2SD2150T100R](#) [SP000011176](#) [FMC5AT148](#) [2N2369ADCSM](#) [2SB1202S-TL-E](#) [2SC2412KT146S](#) [2SC4618TLN](#) [2SC5490A-TL-H](#)
[2SD1816S-TL-E](#) [2SD1816T-TL-E](#) [CMXT2207 TR](#) [CPH6501-TL-E](#) [MCH4021-TL-E](#) [BC557B](#) [TTC012\(Q\)](#) [BULD128DT4](#) [JANTX2N3810](#)
[Jantx2N5416](#) [US6T6TR](#) [KSF350](#) [068071B](#)