



PJ78L05SQ

3-Terminal Voltage Regulator

Features

- Input voltage: up to 30V
- Output: 5V
- Output current up to 100 mA, internal thermal overload protection and short-circuit limiting.

SOT-89

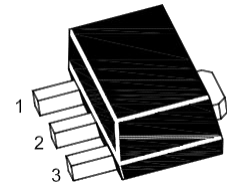

1. OUT 2. GND 3. IN

Maximum Ratings

Ratings at $T_A = 25^\circ\text{C}$ ambient temperature unless otherwise specified.

Parameter	Symbols	Value	Units
Input Voltage	V_I	30	V
Output Current	I_O	100	mA
Junction Temperature	T_J	150	$^\circ\text{C}$
Operating Temperature Range	T_{OPR}	-40~125	$^\circ\text{C}$
Power Dissipation	P_D	500	mW
Storage Temperature Range	T_{STG}	-55~150	$^\circ\text{C}$

Electrical Characteristics

Ratings at $T_A = 25^\circ\text{C}$ ambient temperature unless otherwise specified.

Parameter	Symbols	Test Conditions	Min	Typ	Max	Unit
Output Voltage	V_O	$I_O=40\text{mA}$ $T_J=25^\circ\text{C}$	4.80	5.0	5.2	V
		$I_O=1\text{mA to }40\text{mA}$ $V_I=7\text{V to }20\text{V}$	4.75	5.0	5.25	V
		$I_O=1\text{mA to }70\text{mA}$ $V_I=10\text{V}$	4.75	5.0	5.25	V
Line Regulation	ΔV_O	$V_I=7\text{V to }20\text{V}$ $T_J=25^\circ\text{C}$		32	150	mV
		$V_I=8\text{V to }20\text{V}$ $T_J=25^\circ\text{C}$		26	100	mV
Load Regulation	ΔV_O	$I_O=1\text{mA to }100\text{mA}$ $T_J=25^\circ\text{C}$		15	60	mV
		$I_O=1\text{mA to }40\text{mA}$ $T_J=25^\circ\text{C}$		8	30	mV
Ripple Rejection	RR	$V_I=8\text{V to }18\text{V}$ $T_J=25^\circ\text{C}$ $f=120\text{Hz}$	41	49		dB
Output Noise Voltage	eN	$f=10\text{Hz}\sim 100\text{KHz}$ $T_J=25^\circ\text{C}$		42		μV
Dropout Voltage	V_D	$T_J=25^\circ\text{C}$		1.7		V
Quiescent Current	I_Q	$T_J=25^\circ\text{C}$		3.8	6	mA
		$T_J=125^\circ\text{C}$			5.5	mA
Quiescent Current Change	ΔI_Q	$V_I=8\text{V to }20\text{V}$			1.5	mA
		$I_O=1\text{mA to }40\text{mA}$			0.1	mA



Ratings and Characteristic Curves

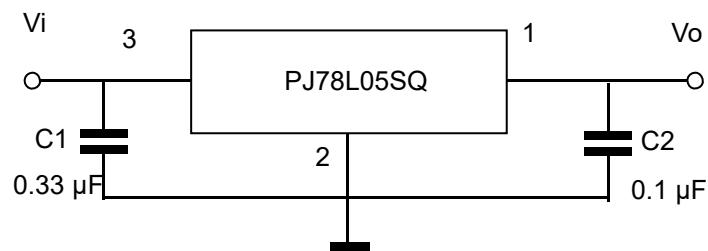
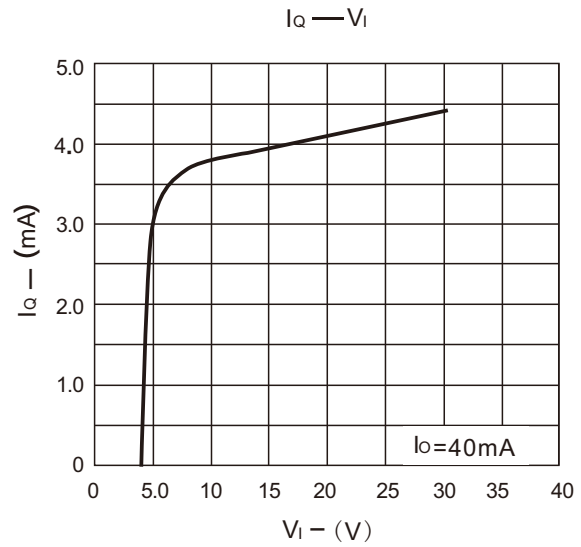
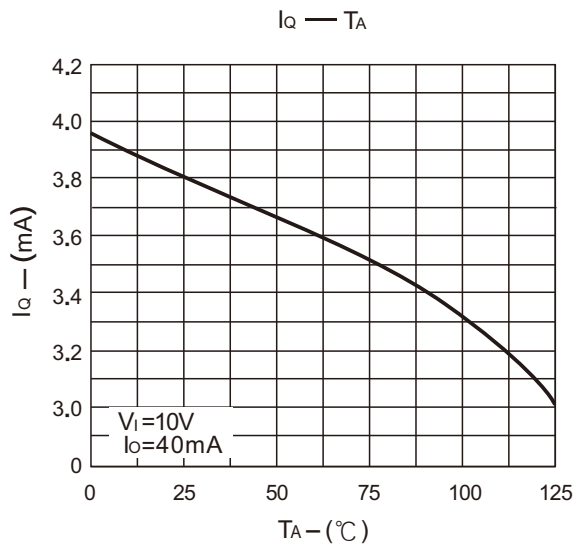
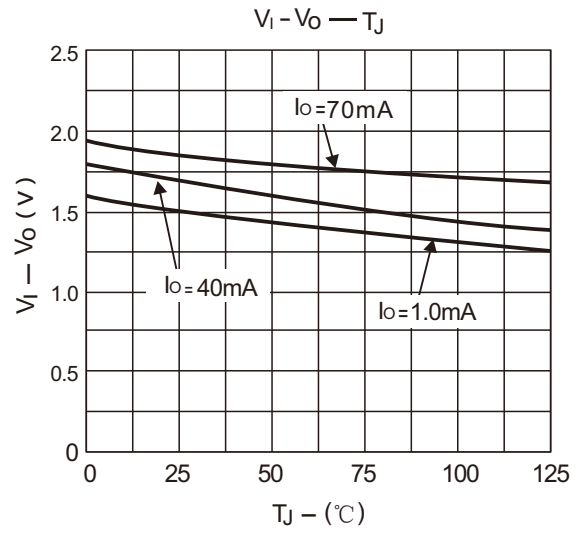
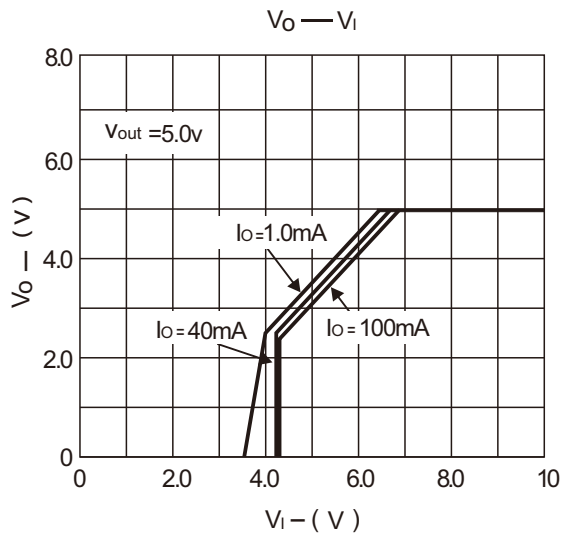



PJ78L05SQ

3-Terminal Voltage Regulator

Package Outline

SOT-89

Dimensions in mm

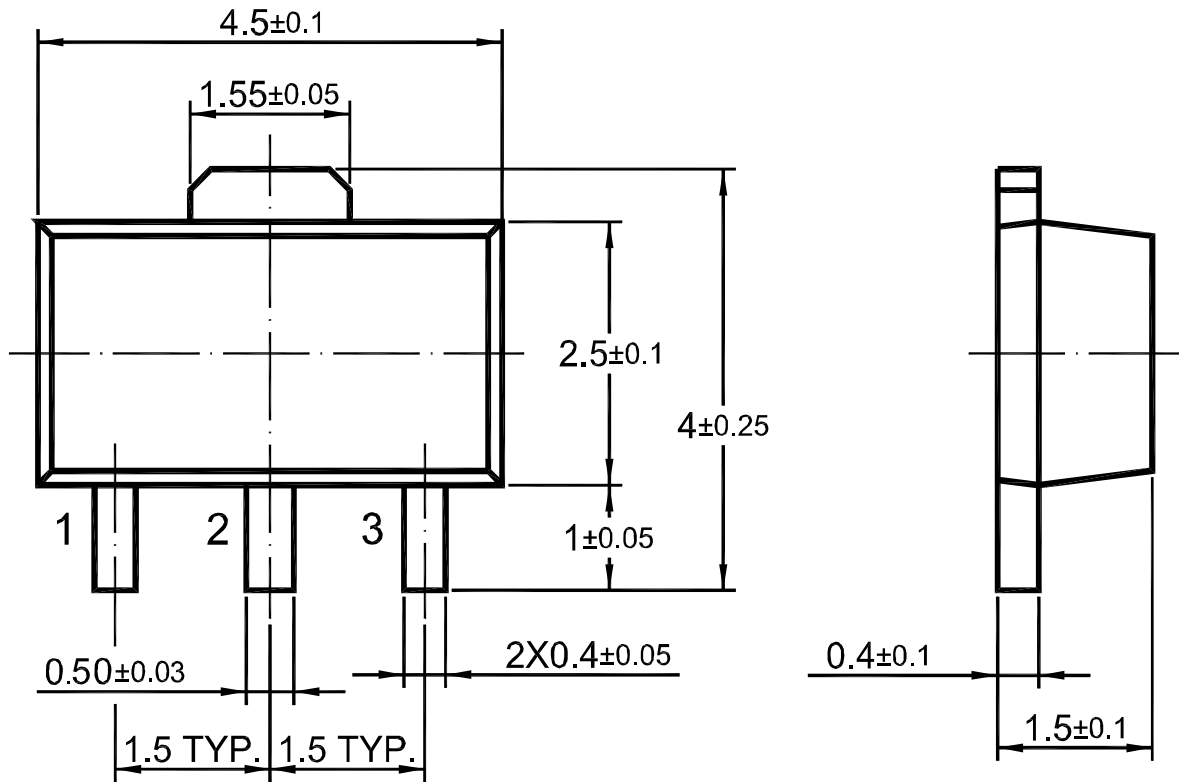

Ordering Information

Device	Package	Shipping
PJ78L05SQ	SOT-89	1,000/ Tape & Reel (7 inches)

X-ON Electronics

Largest Supplier of Electrical and Electronic Components

Click to view similar products for [Linear Voltage Regulators](#) category:

Click to view products by [Pingjingsemi](#) manufacturer:

Other Similar products are found below :

[LV56831P-E](#) [LV5684PVD-XH](#) [MCDTSA6-2R](#) [L4953G](#) [L7815ACV-DG](#) [PQ3DZ53U](#) [LV56801P-E](#) [TCR3DF13,LM\(CT](#)
[TCR3DF39,LM\(CT](#) [TLE42794G](#) [L78L05CZ/1SX](#) [L78LR05DL-MA-E](#) [L78MR05-E](#) [033150D](#) [033151B](#) [090756R](#) [636416C](#)
[NCV78M15BDTG](#) [702482B](#) [714954EB](#) [TLE42794GM](#) [TLE42994GM](#) [ZMR500QFTA](#) [BA033LBSG2-TR](#) [NCV78M05ABDTRKG](#)
[NCV78M08BDTRKG](#) [NCP7808TG](#) [NCV571SN12T1G](#) [LV5680P-E](#) [CAJ24C256YI-GT3](#) [L78M15CV-DG](#) [L9474N](#)
[TLS202B1MBV33HTSA1](#) [L79M05T-E](#) [NCP571SN09T1G](#) [MAX15006AASA/V+](#) [MIC5283-5.0YML-T5](#) [L4969URTR-E](#) [L78LR05D-MA-E](#)
[NCV7808BDTRKG](#) [L9466N](#) [NCP7805ETG](#) [SC7812CTG](#) [NCV7809BTG](#) [NCV571SN09T1G](#) [NCV317MBTG](#) [MC78M15CDTT5G](#)
[MC78M12CDTT5G](#) [L9468N](#) [LT1054IS8#TRPBF](#)