



# PJ78L06SQ

## 3-Terminal Voltage Regulator

### Features

- Input voltage: up to 30V
- Output: 6V
- Output current up to 100 mA, internal thermal overload protection and short-circuit limiting.

SOT-89

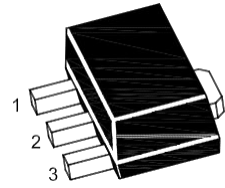

1. OUT 2. GND 3. IN

### Maximum Ratings

Ratings at  $T_A = 25^\circ\text{C}$  ambient temperature unless otherwise specified.

Parameter	Symbols	Value	Units
Input Voltage	$V_I$	30	V
Output Current	$I_o$	100	mA
Junction Temperature	$T_J$	150	$^\circ\text{C}$
Operating Temperature Range	$T_{\text{OPR}}$	-40~125	$^\circ\text{C}$
Power Dissipation	$P_D$	500	mW
Storage Temperature Range	$T_{\text{STG}}$	-55~150	$^\circ\text{C}$

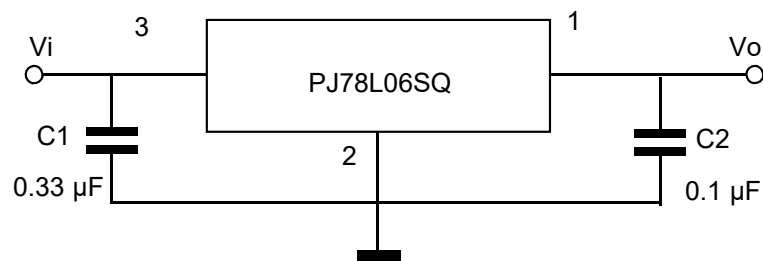



# PJ78L06SQ

## 3-Terminal Voltage Regulator

### Electrical Characteristics

Ratings at  $T_A = 25^\circ\text{C}$  ambient temperature,  $0^\circ\text{C} \leq T_J \leq 125^\circ\text{C}$   $V_I = 11\text{V}$ ,  $I_O = 40\text{mA}$ ,  $C_i = 0.33\mu\text{F}$ ,  $C_o = 0.1\mu\text{F}$ , unless otherwise specified.

Parameter	Symbols	Test Conditions	Min	Typ	Max	Unit
Output Voltage	$V_O$	$T_J = 25^\circ\text{C}$	5.76	6	6.24	V
		$I_O = 1\text{mA to } 40\text{mA}$ $V_I = 8.5\text{V to } 21\text{V}$	5.7	6	6.3	V
		$I_O = 1\text{mA to } 70\text{mA}$ $V_I = 11\text{V}$	5.7	6	6.3	V
Line Regulation	$\Delta V_O$	$V_I = 8.5\text{V to } 21\text{V}$ $T_J = 25^\circ\text{C}$			155	mV
		$V_I = 9\text{V to } 21\text{V}$ $T_J = 25^\circ\text{C}$			105	mV
Load Regulation	$\Delta V_O$	$I_O = 1\text{mA to } 100\text{mA}$ , $T_J = 25^\circ\text{C}$			65	mV
		$I_O = 1\text{mA to } 40\text{mA}$ , $T_J = 25^\circ\text{C}$			35	mV
Ripple Rejection	RR	$V_I = 9\text{V to } 19\text{V}$ , $T_J = 25^\circ\text{C}$ $f = 120\text{Hz}$	40			dB
Output Noise Voltage	$V_N$	$f = 10\text{Hz} \sim 100\text{KHz}$ $T_J = 25^\circ\text{C}$		49		$\mu\text{V}$
Dropout Voltage	$V_D$	$T_J = 25^\circ\text{C}$		1.7		V
Quiescent Current	$I_Q$	$T_J = 25^\circ\text{C}$			5.5	mA
Quiescent Current Change	$\Delta I_Q$	$V_I = 9\text{V to } 21\text{V}$ , $I_O = 40\text{mA}$			1.5	mA
		$V_I = 11\text{V}$ , $I_O = 1\text{mA to } 40\text{mA}$			0.1	mA



# PJ78L06SQ

## 3-Terminal Voltage Regulator

### Ratings and Characteristic Curves

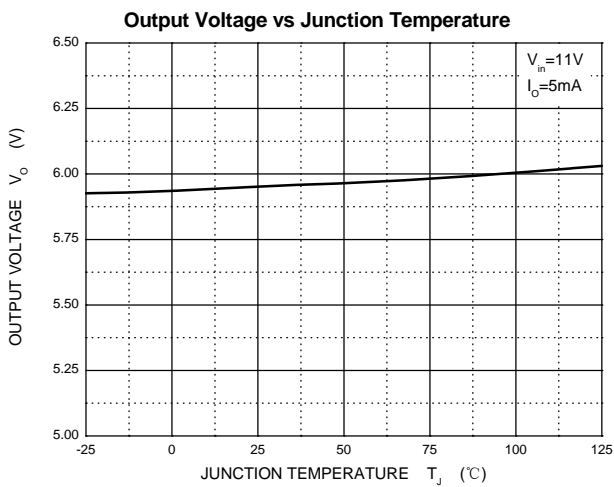
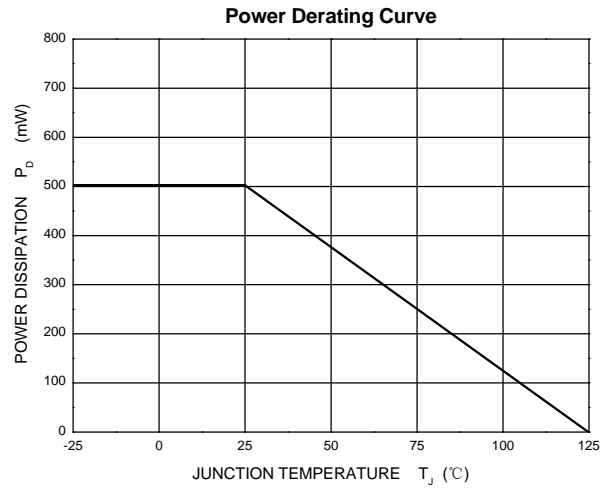
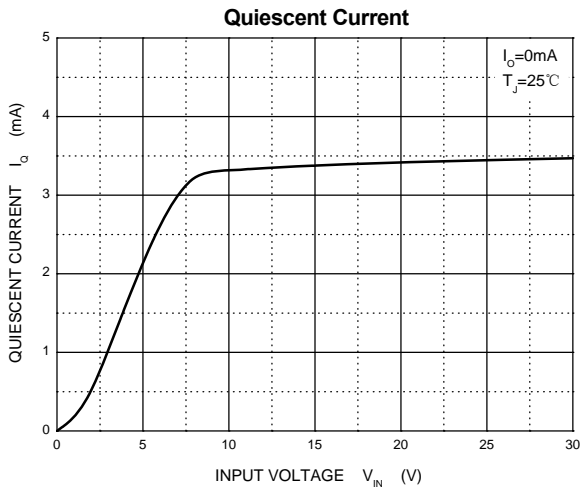
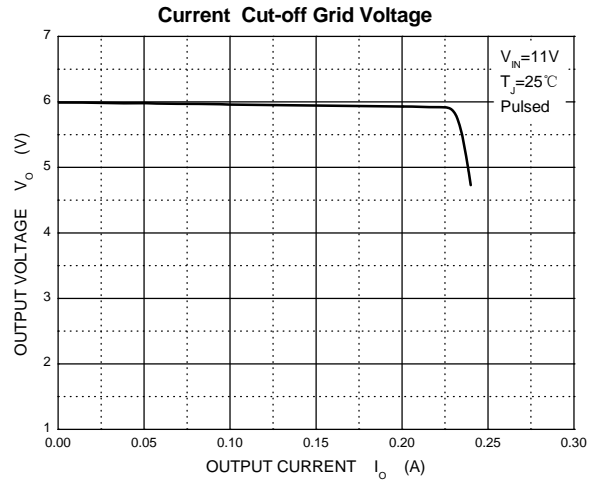
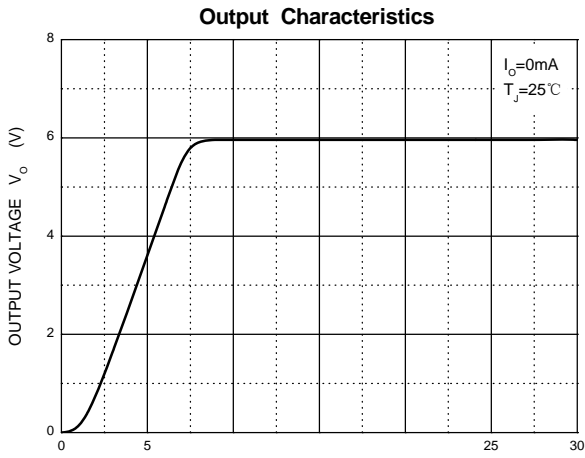



# PJ78L06SQ

## 3-Terminal Voltage Regulator

### Package Outline

SOT-89

Dimensions in mm

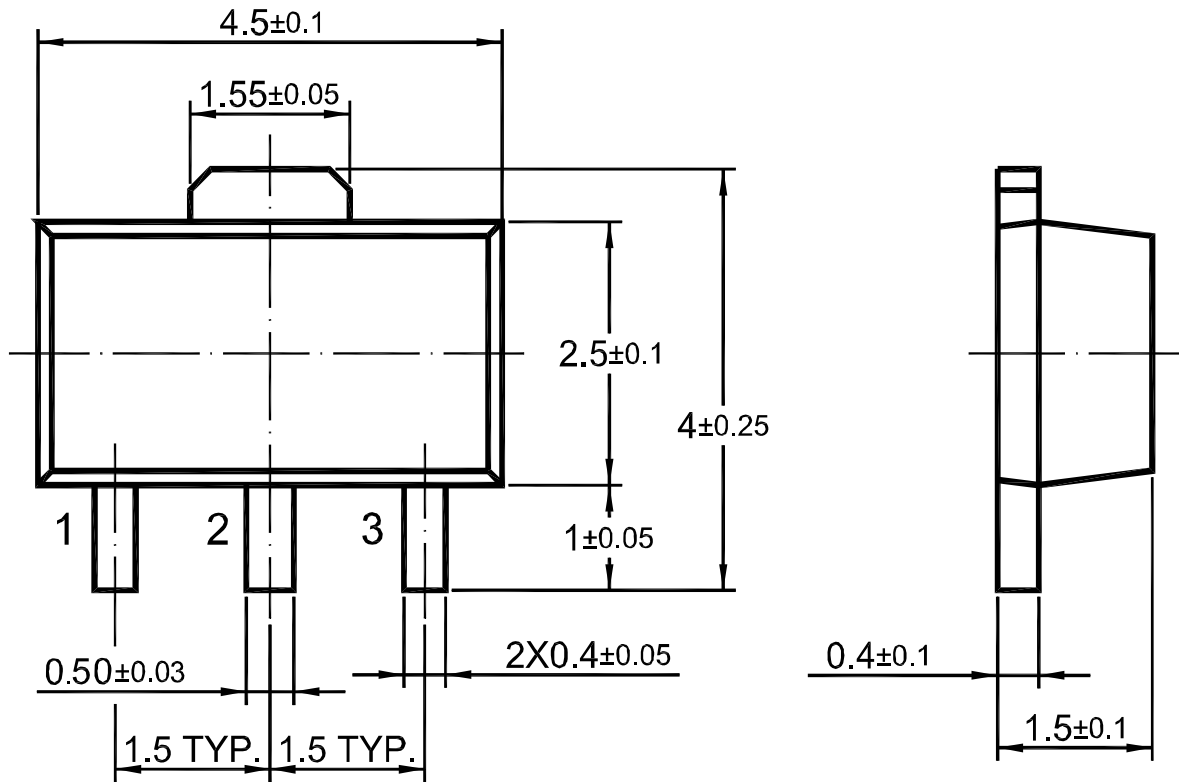

### Ordering Information

Device	Package	Shipping
PJ78L06SQ	SOT-89	1,000/ Tape & Reel (7 inches)

## X-ON Electronics

Largest Supplier of Electrical and Electronic Components

*Click to view similar products for [Linear Voltage Regulators](#) category:*

*Click to view products by [Pingjingsemi](#) manufacturer:*

Other Similar products are found below :

[LV56831P-E](#) [LV5684PVD-XH](#) [MCDTSA6-2R](#) [L4953G](#) [L7815ACV-DG](#) [PQ3DZ53U](#) [LV56801P-E](#) [TCR3DF13,LM\(CT](#)  
[TCR3DF39,LM\(CT](#) [TLE42794G](#) [L78L05CZ/1SX](#) [L78LR05DL-MA-E](#) [L78MR05-E](#) [033150D](#) [033151B](#) [090756R](#) [636416C](#)  
[NCV78M15BDTG](#) [702482B](#) [714954EB](#) [TLE42794GM](#) [TLE42994GM](#) [ZMR500QFTA](#) [BA033LBSG2-TR](#) [NCV78M05ABDTRKG](#)  
[NCV78M08BDTRKG](#) [NCP7808TG](#) [NCV571SN12T1G](#) [LV5680P-E](#) [CAJ24C256YI-GT3](#) [L78M15CV-DG](#) [L9474N](#)  
[TLS202B1MBV33HTSA1](#) [L79M05T-E](#) [NCP571SN09T1G](#) [MAX15006AASA/V+](#) [MIC5283-5.0YML-T5](#) [L4969URTR-E](#) [L78LR05D-MA-E](#)  
[NCV7808BDTRKG](#) [L9466N](#) [NCP7805ETG](#) [SC7812CTG](#) [NCV7809BTG](#) [NCV571SN09T1G](#) [NCV317MBTG](#) [MC78M15CDTT5G](#)  
[MC78M12CDTT5G](#) [L9468N](#) [LT1054IS8#TRPBF](#)