

# 100N10NF

## 100 Amps, 100 Volts N-CHANNEL Power MOSFET

### FEATURE

- 100A, 100V,  $R_{DS(ON)MAX}=8.4m\Omega$   $V_{GS}=10V/20A$
- Low gate charge
- Low  $C_{iss}$
- Fast switching
- 100% avalanche tested
- Improved dv/dt capability

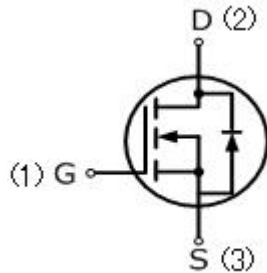

### TO-220NF

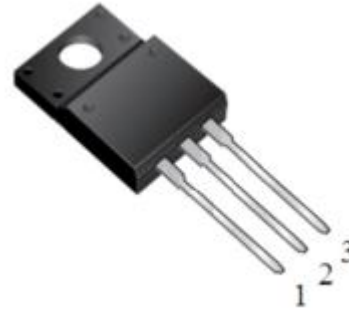

### Absolute Maximum Ratings ( $T_C=25^\circ C$ , unless otherwise noted)

Parameter	Symbol	100N10NF	UNIT
Drain-Source Voltage	$V_{DSS}$	100	V
Gate-Source Voltage	$V_{GSS}$	$\pm 20$	
Continuous Drain Current	$I_D$	100	A
Pulsed Drain Current (Note 1)	$I_{DM}$	400	
Single Pulse Avalanche Energy (Note 2)	$E_{AS}$	180	mJ
Operating Junction and Storage Temperature Range	$T_J, T_{STG}$	-55 to +150	$^\circ C$
Channel Temperature	$T_{CH}$	150	$^\circ C$
Maximum lead temperature for soldering purposes, 1/8" from case for 5 seconds	$T_L$	260	$^\circ C$

Parameter	Symbol	TO-220NF	Units
Thermal resistance, Channel to Case	$R_{th(ch-c)}$	2.53	$^\circ C/W$
Maximum Power Dissipation	$P_D$	50	W

<b>Electrical Characteristics</b> ( $T_c=25^\circ\text{C}$ , unless otherwise noted)						
Parameter	Symbol	Test Conditions	Min	Typ	Max	Units
<b>Off Characteristics</b>						
Drain-Source Breakdown Voltage	$BV_{DSS}$	$V_{GS}=0V, I_D=250\mu A$	100	—	—	V
Zero Gate Voltage Drain Current	$I_{DSS}$	$V_{DS}=100V, V_{GS}=0V$	—	—	1	$\mu A$
Gate-Body Leakage Current, Forward	$I_{GSS}$	$V_{GS}=\pm 20V, V_{DS}=0V$	—	—	$\pm 100$	nA
<b>On Characteristics</b>						
Gate-Source Threshold Voltage	$V_{GS(th)}$	$V_{DS}=10V, I_D=250\mu A$	2.0	—	4.0	V
Drain-Source On-State Resistance	$R_{DS(on)}$	$V_{GS}=10V, I_D=20A$	—	7.5	8.4	m $\Omega$
<b>Dynamic Characteristics</b>						
Input Capacitance	$C_{iss}$	$V_{DS}=50V, V_{GS}=0V,$ $f=1.0\text{MHZ}$	—	2605	—	pF
Output Capacitance	$C_{oss}$		—	172	—	pF
Reverse Transfer Capacitance	$C_{rss}$		—	14	—	pF
<b>Switching Characteristics</b>						
Turn-On Delay Time	$t_{d(on)}$	$V_{DD}=50V,$ $R_L=6.25\Omega,$ $R_{GEN}=3\Omega$ $V_{GS}=10V$ (Note3,4)	—	7	—	ns
Turn-On Rise Time	$t_r$		—	3	—	ns
Turn-Off Delay Time	$t_{d(off)}$		—	20	—	ns
Turn-Off Fall Time	$t_f$		—	3	—	ns
Total Gate Charge	$Q_g$	$V_{DS}=50V, I_D=20A,$ $V_{GS}=10V,$ (Note3,4)	—	32	—	nC
Gate-Source Charge	$Q_{gs}$		—	7	—	nC
Gate-Drain Charge	$Q_{gd}$		—	4	—	nC
<b>Drain-Source Body Diode Characteristics and Maximum Ratings</b>						
Continuous Diode Forward Current	$I_S$	$V_G = V_D = 0V,$ Force Current	—	—	100	A
Pulsed Diode Forward Current	$I_{SM}$		—	—	400	A
Diode Forward Voltage	$V_{SD}$	$I_S=20A, V_{GS}=0V$	—	—	1.3	V

#### Notes

1. Repetitive Rating: pulse width limited by maximum junction temperature.
2.  $L=0.4\text{mH}, R_g=25\Omega, I_{AS}=30A$ , starting  $T_j=25^\circ\text{C}$ .
3.  $di/dt=200A/\mu s$ , starting  $T_j=25^\circ\text{C}$ , Pulse width  $\leq 300\mu s$ ; duty cycle  $\leq 2\%$ .
4. Repetitive rating; pulse width limited by maximum junction temperature.

## RATING AND CHARACTERISTIC CURVES

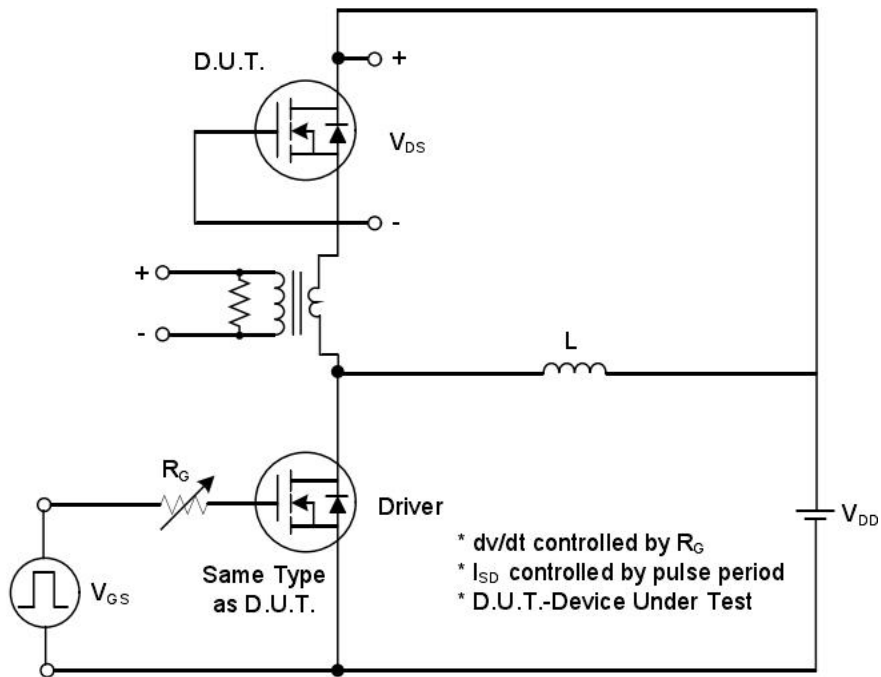

Peak Diode Recovery dv/dt Test Circuit



Peak Diode Recovery dv/dt Waveforms

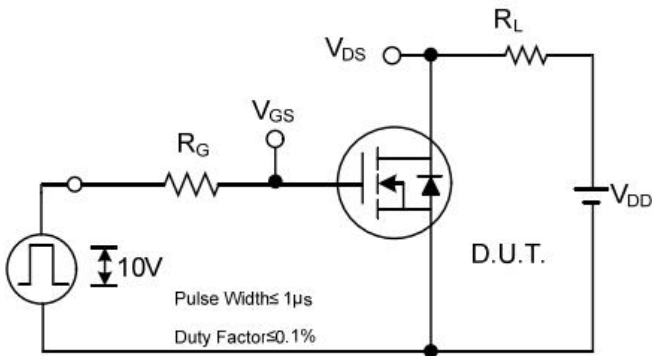

**Switching Test Circuit**



**Switching Waveforms**

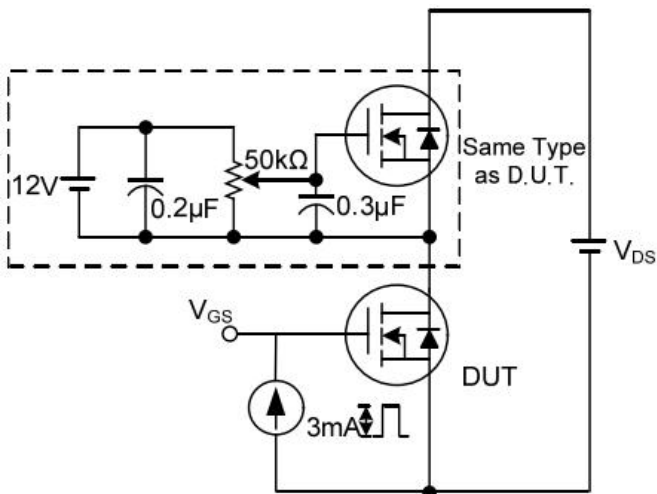

**Gate Charge Test Circuit**

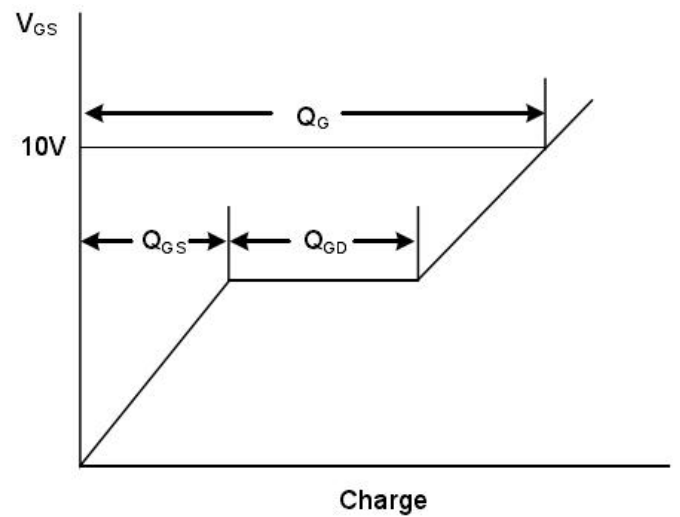

**Gate Charge Waveform**



**Unclamped Inductive Switching Test Circuit**

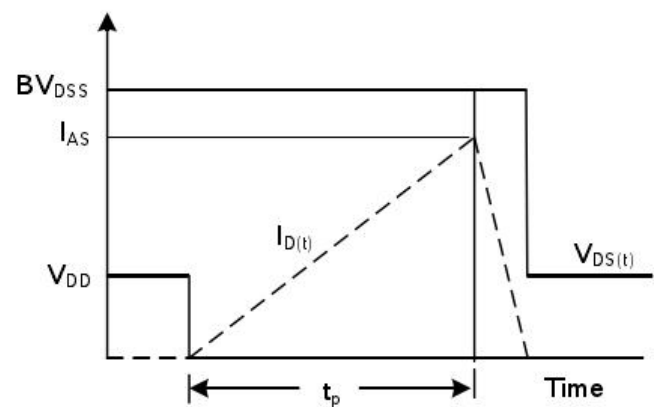

**Unclamped Inductive Switching Waveforms**

## RATING AND CHARACTERISTIC CURVES

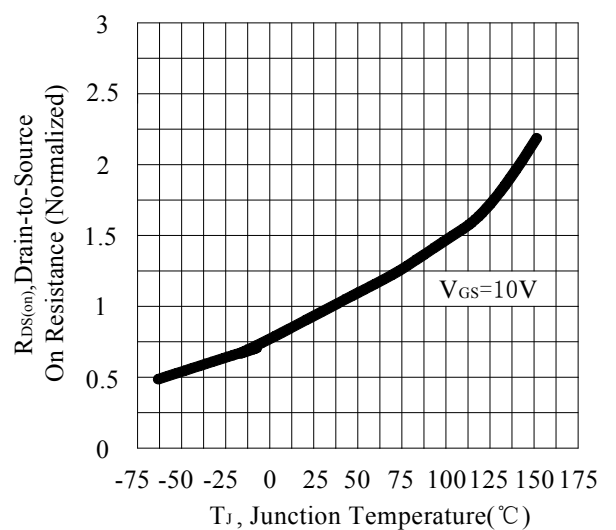
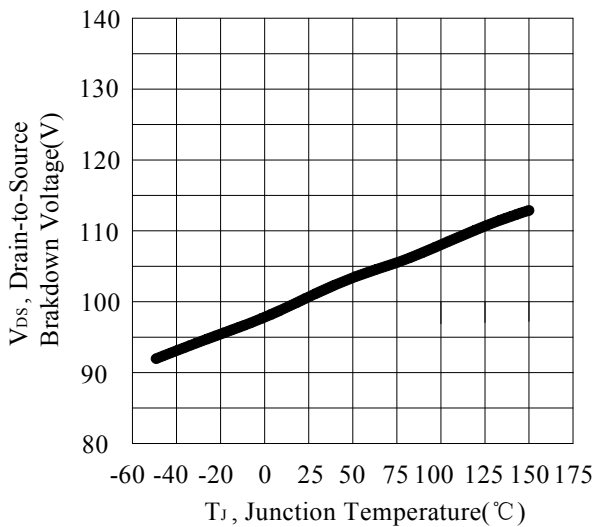
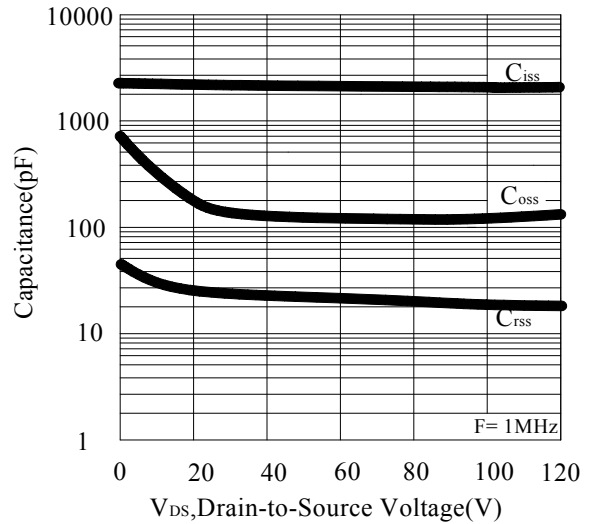
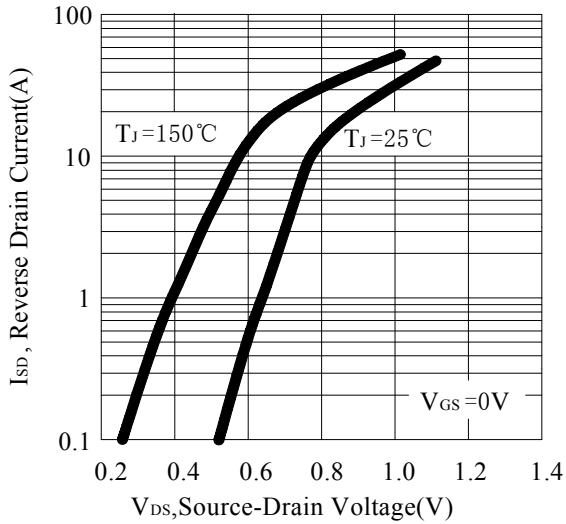
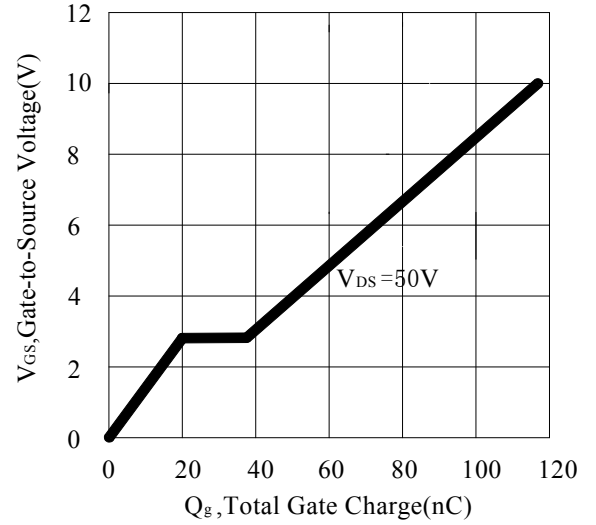
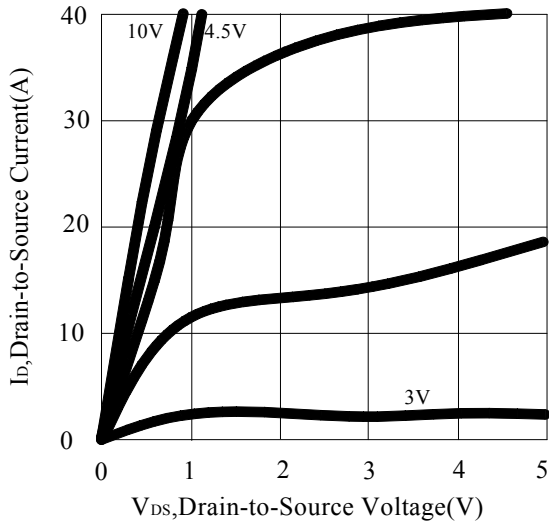

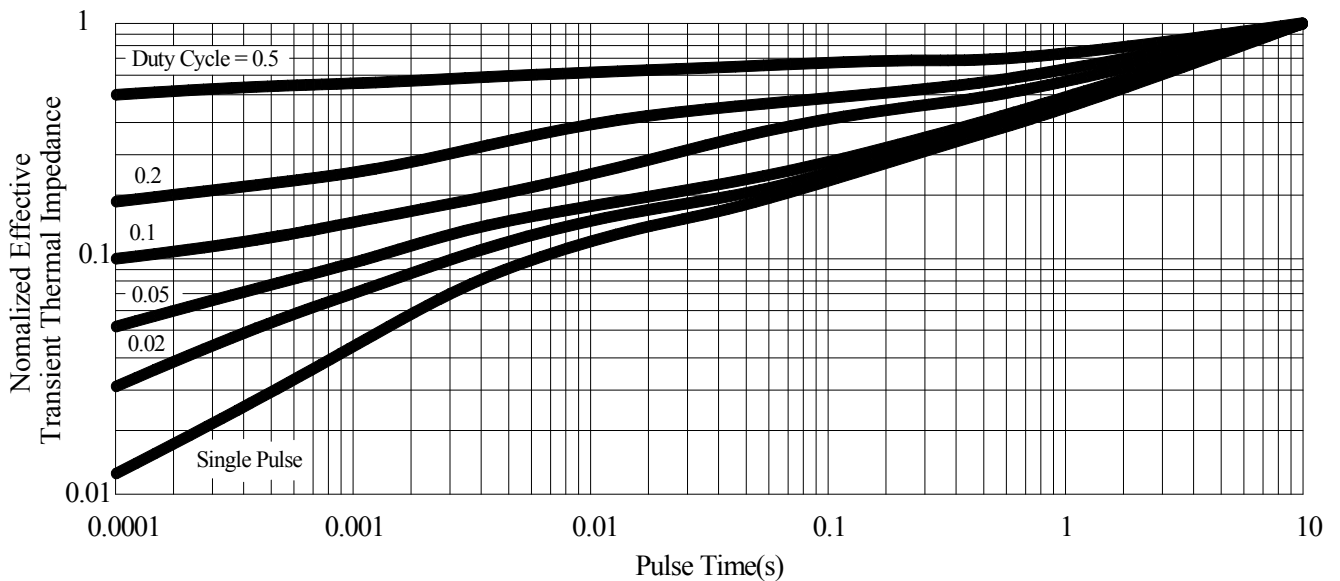
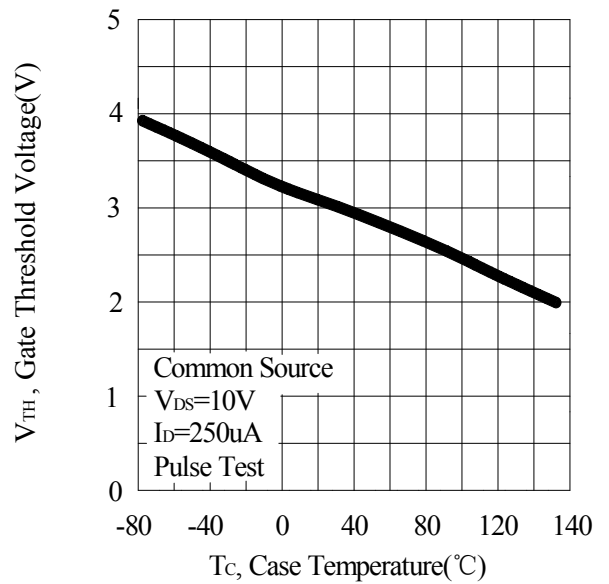
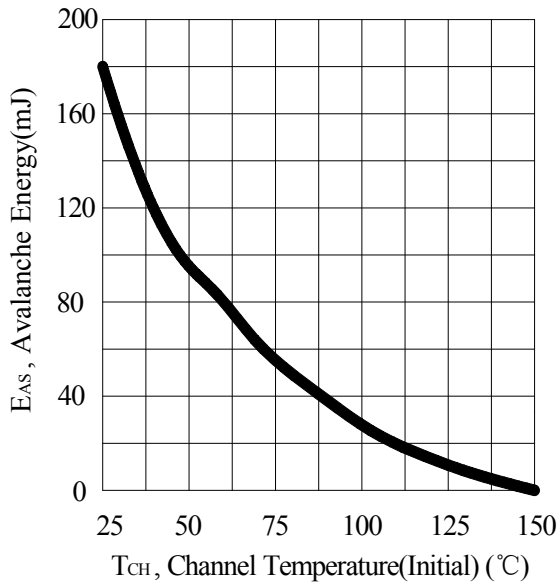
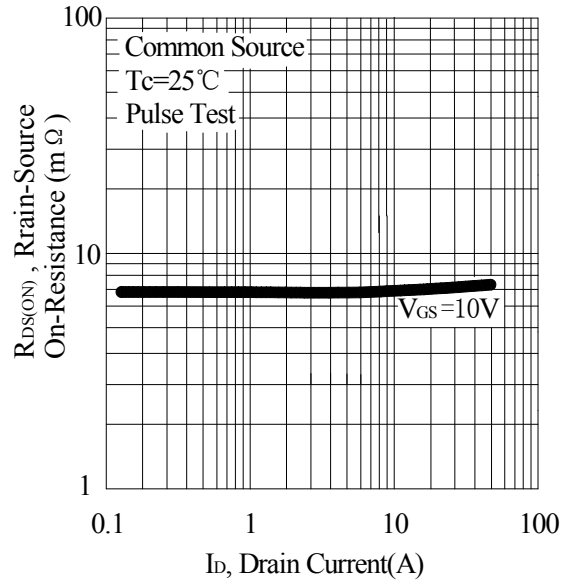
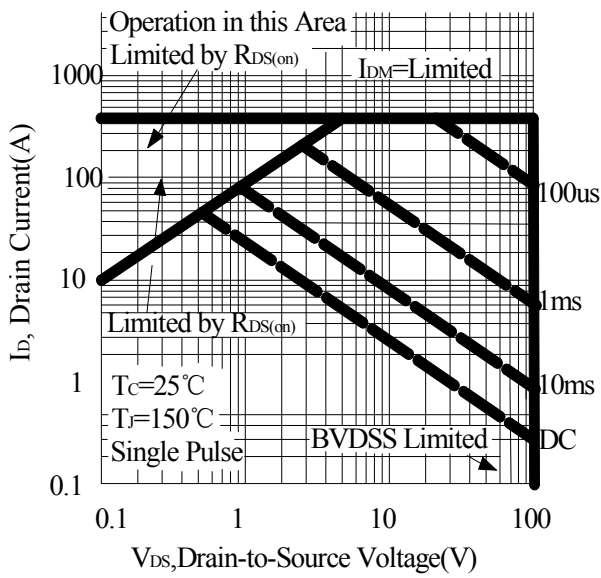

## PACKAGE OUTLINE DIMENSIONS

### TO-220NF

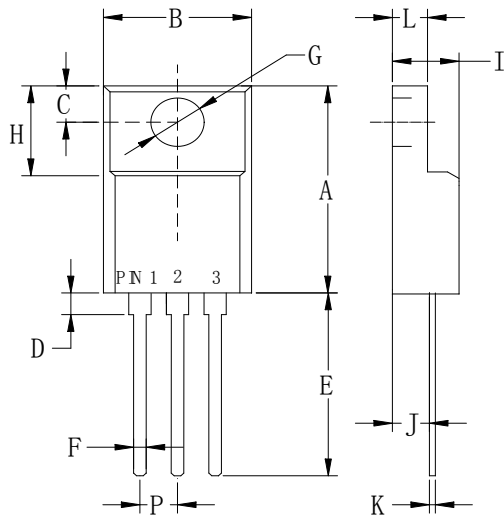

TO-220NF		
Dim	Min	Max
A	.590 (15.0)	.650 (16.5)
B	.393 (10.0)	.414 (10.5)
C	.118 (3.00)	.138 (3.50)
D	.027 (0.7)	.038 (0.95)
E	.490 (12.5)	.531 (13.5)
F	.020 (0.53)	.029 (0.73)
G	.125 (3.20)	.146 (3.70)
H	.255 (6.50)	.280 (7.10)
I	.173 (4.40)	.197 (5.00)
J	.098 (2.50)	.114 (2.90)
K	.018 (0.45)	.026 (0.65)
L	.092 (2.35)	.109 (2.75)
P	.890 (2.25)	.113 (2.85)

## X-ON Electronics

Largest Supplier of Electrical and Electronic Components

*Click to view similar products for [MOSFET](#) category:*

*Click to view products by [Pingwei](#) manufacturer:*

Other Similar products are found below :

[614233C](#) [648584F](#) [MCH3443-TL-E](#) [MCH6422-TL-E](#) [FDPF9N50NZ](#) [FW216A-TL-2W](#) [FW231A-TL-E](#) [APT5010JVR](#) [NTNS3A92PZT5G](#)  
[IRF100S201](#) [JANTX2N5237](#) [2SK2464-TL-E](#) [2SK3818-DL-E](#) [FCA20N60\\_F109](#) [FDZ595PZ](#) [STD6600NT4G](#) [FSS804-TL-E](#) [2SJ277-DL-E](#)  
[2SK1691-DL-E](#) [2SK2545\(Q,T\)](#) [D2294UK](#) [405094E](#) [423220D](#) [MCH6646-TL-E](#) [TPCC8103,L1Q\(CM](#) [367-8430-0972-503](#) [VN1206L](#)  
[424134F](#) [026935X](#) [051075F](#) [SBVS138LT1G](#) [614234A](#) [715780A](#) [NTNS3166NZT5G](#) [751625C](#) [873612G](#) [IRF7380TRHR](#)  
[IPS70R2K0CEAKMA1](#) [RJK60S3DPP-E0#T2](#) [RJK60S5DPK-M0#T0](#) [APT5010JVFR](#) [APT12031JFLL](#) [APT12040JVR](#) [DMN3404LQ-7](#)  
[NTE6400](#) [JANTX2N6796U](#) [JANTX2N6784U](#) [JANTXV2N5416U4](#) [SQM110N05-06L-GE3](#) [SIHF35N60E-GE3](#)