

## 5N65GS

### 5 Amps,650 Volts N-Channel Super Junction Power MOSFET

#### FEATURE

- 5A,650V, $R_{DS(ON)MAX}=0.90\ \Omega$  @ $V_{GS}=10V/2.5A$
- Low gate charge
- Low  $C_{iss}$
- Fast switching
- 100% avalanche tested
- Improved dv/dt capability

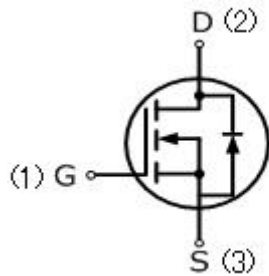

#### TO-252

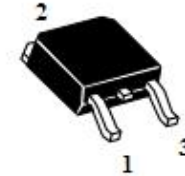

#### Absolute Maximum Ratings ( $T_C=25^\circ\text{C}$ , unless otherwise noted)

Parameter	Symbol	5N65GS	UNIT
Drain-Source Voltage	$V_{DSS}$	650	V
Gate-Source Voltage	$V_{GSS}$	$\pm 25$	
Continuous Drain Current	$I_D$	5	A
Pulsed Drain Current (Note 1)	$I_{DM}$	15	
Single Pulse Avalanche Energy (Note 2)	$E_{AS}$	100	mJ
Avalanche Current (Note 1)	$I_{AR}$	2.5	A
Repetitive Avalanche Energy (Note 1)	$E_{AR}$	0.4	mJ
Reverse Diode dv/dt (Note 3)	dv/dt	15	V/ns
Operating Junction and Storage Temperature Range	$T_J, T_{STG}$	-55 to +150	$^\circ\text{C}$
Maximum lead temperature for soldering purposes, 1/8" from case for 5 seconds	$T_L$	260	$^\circ\text{C}$

#### Thermal Characteristics

Parameter	Symbol	TO-252	Units
Thermal resistance , Channel to Case	$R_{th(ch-c)}$	2.55	$^\circ\text{C}/\text{W}$
Thermal resistance , Channel to Ambient	$R_{th(ch-a)}$	62	$^\circ\text{C}/\text{W}$
Maximum Power Dissipation	$T_C=25^\circ\text{C}$ $P_D$	45	W

<b>Electrical Characteristics</b> ( $T_c=25^\circ\text{C}$ , unless otherwise noted)						
Parameter	Symbol	Test Conditions	Min	Typ	Max	Units
<b>Off Characteristics</b>						
Drain-Source Breakdown Voltage	$BV_{DSS}$	$V_{GS}=0V, I_D=250\mu A$	650	—	—	V
Breakdown Temperature Coefficient	$\Delta BV_{DSS} / \Delta T_J$	Reference to $25^\circ\text{C}$ , $I_D=250\mu A$	—	0.6	—	$V/^\circ\text{C}$
Zero Gate Voltage Drain Current	$I_{DSS}$	$V_{DS}=650V, V_{GS}=0V$	—	—	1	$\mu A$
Gate-Body Leakage Current, Forward	$I_{GSSF}$	$V_{GS}=20V, V_{DS}=0V$	—	—	100	nA
Gate-Body Leakage Current, Reverse	$I_{GSSR}$	$V_{GS}=-20V, V_{DS}=0V$	—	—	-100	nA
<b>On Characteristics</b>						
Gate-Source Threshold Voltage	$V_{GS(th)}$	$V_{DS}=V_{GS}, I_D=250\mu A$	2	—	4	V
Drain-Source On-State Resistance	$R_{DS(on)}$	$V_{GS}=10V, I_D=2.5A$	—	0.74	0.90	$\Omega$
<b>Dynamic Characteristics</b>						
Input Capacitance	$C_{iss}$	$V_{DS}=50V, V_{GS}=0V,$ $f=1.0\text{MHz}$	—	460	—	pF
Output Capacitance	$C_{oss}$		—	45	—	pF
Reverse Transfer Capacitance	$C_{rss}$		—	3.5	—	pF
<b>Switching Characteristics</b>						
Turn-On Delay Time	$t_{d(on)}$	$V_{DD}=380V, I_D=5A,$ $R_G=18\Omega$ (Note4,5)	—	6	—	ns
Turn-On Rise Time	$t_r$		—	3	—	ns
Turn-Off Delay Time	$t_{d(off)}$		—	50	—	ns
Turn-Off Fall Time	$t_f$		—	9	—	ns
Total Gate Charge	$Q_g$	$V_{DS}=480V, I_D=5A,$ $V_{GS}=10V,$ (Note4,5)	—	10	—	nC
Gate-Source Charge	$Q_{gs}$		—	1.6	—	nC
Gate-Drain Charge	$Q_{gd}$		—	4.0	—	nC
<b>Drain-Source Body Diode Characteristics and Maximum Ratings</b>						
Continuous Diode Forward Current	$I_S$		—	—	5	A
Pulsed Diode Forward Current	$I_{SM}$		—	—	15	A
Diode Forward Voltage	$V_{SD}$	$I_S=5A, V_{GS}=0V$	—	—	1.3	V
Reverse Recovery Time	$t_{rr}$	$V_{GS}=0V, I_S=5A,$	—	250	—	ns
Reverse Recovery Charge	$Q_{rr}$	$dI_F/dt=100A/\mu s,$ (Note4)	—	2.2	—	$\mu C$

#### Notes

1. Repetitive Rating: pulse width limited by maximum junction temperature.
2.  $V_{DD}=50V, L=10\text{mH}, R_g=25\Omega, I_{AS}=2.5A$ , starting  $T_J=25^\circ\text{C}$ .
3.  $I_{SD} \leq I_D, dI/dt=200A/\mu s, V_{DD} \leq BV_{DSS}$ , starting  $T_J=25^\circ\text{C}$ .
4. Pulse width  $\leq 300\mu s$ ; duty cycle  $\leq 2\%$ .
5. Repetitive rating; pulse width limited by maximum junction temperature.

**TEST CIRCUIT AND WAVEFORM**

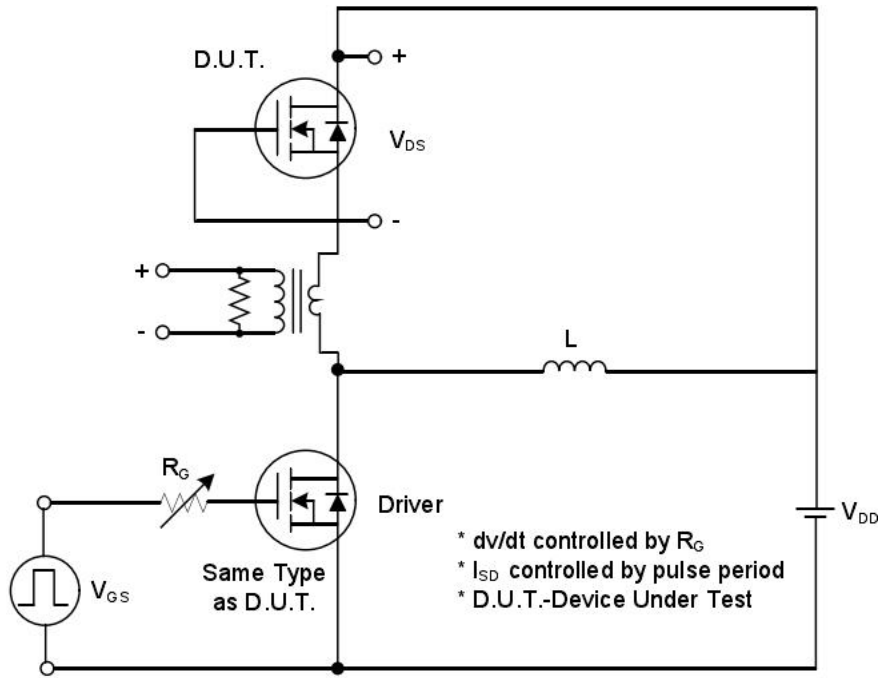

**Peak Diode Recovery dv/dt Test Circuit**

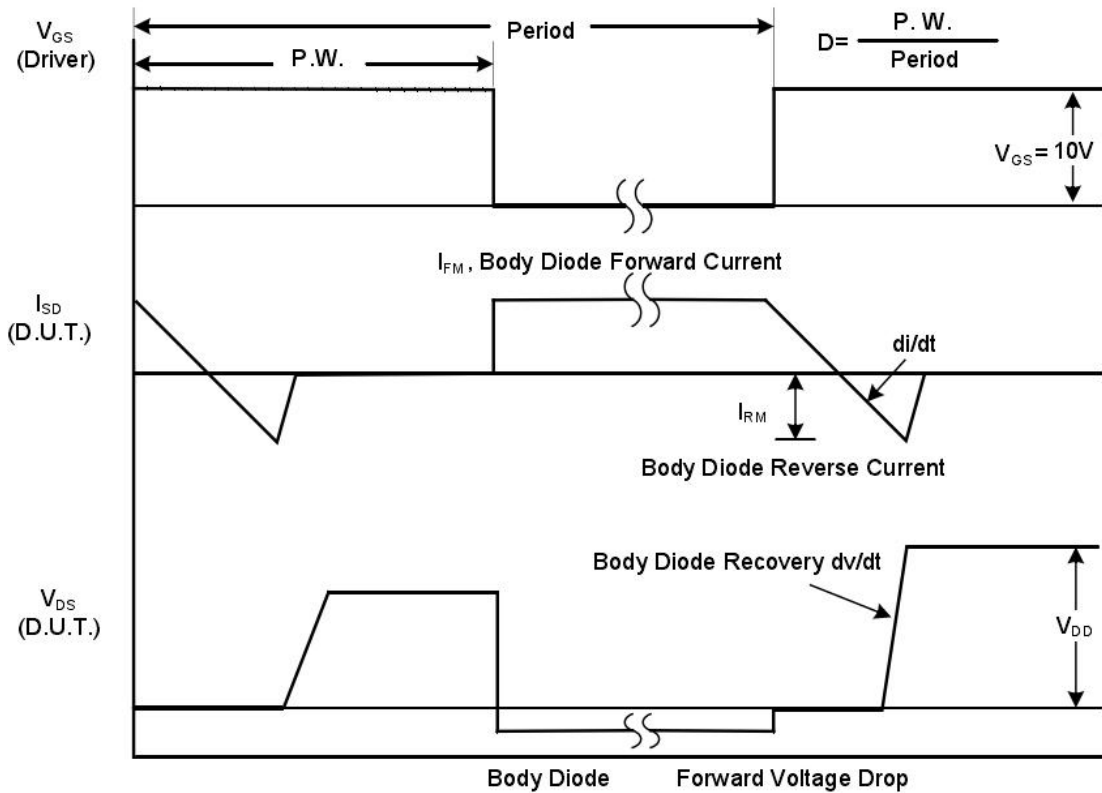

**Peak Diode Recovery dv/dt Waveforms**

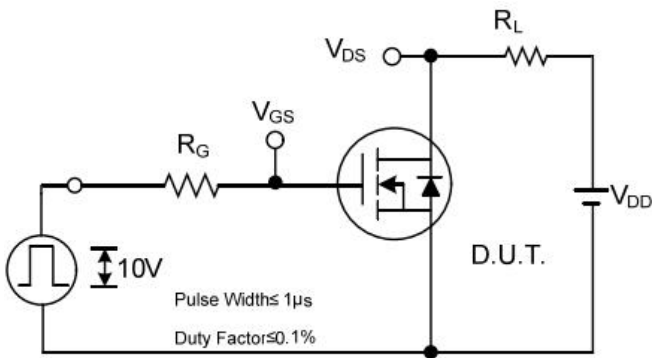

**Switching Test Circuit**

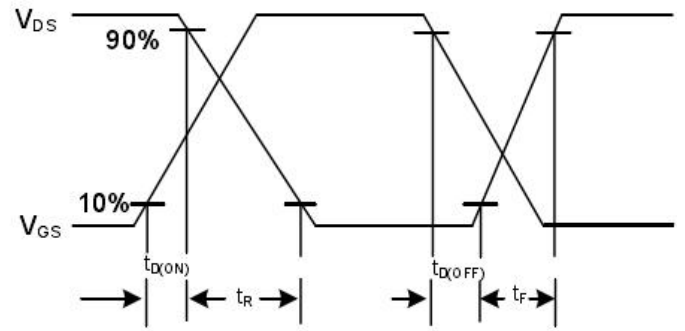

**Switching Waveforms**

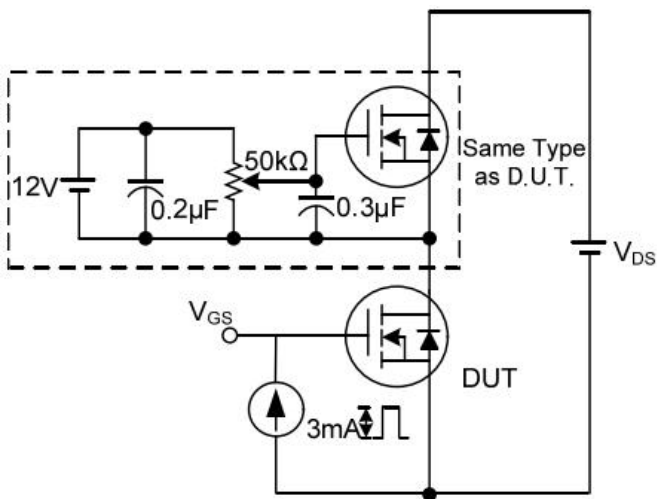

**Gate Charge Test Circuit**

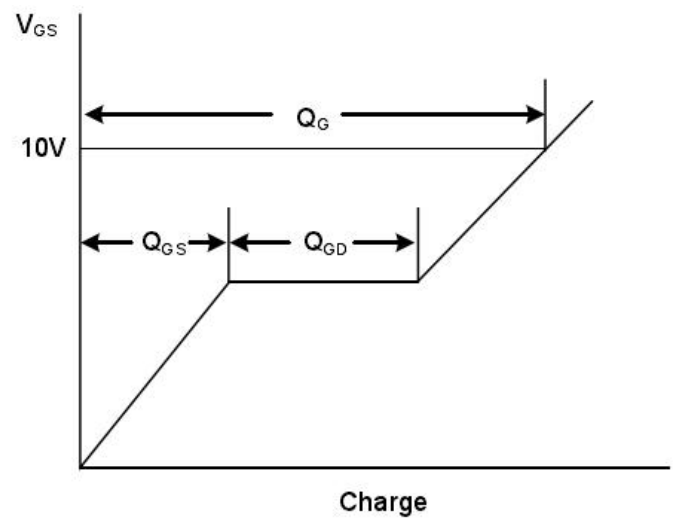

**Gate Charge Waveform**

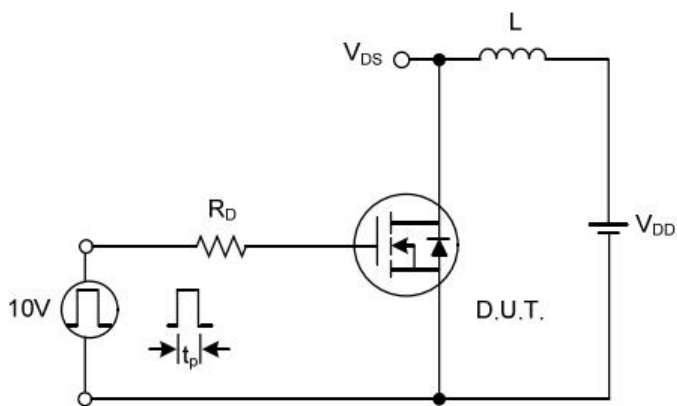

**Unclamped Inductive Switching Test Circuit**

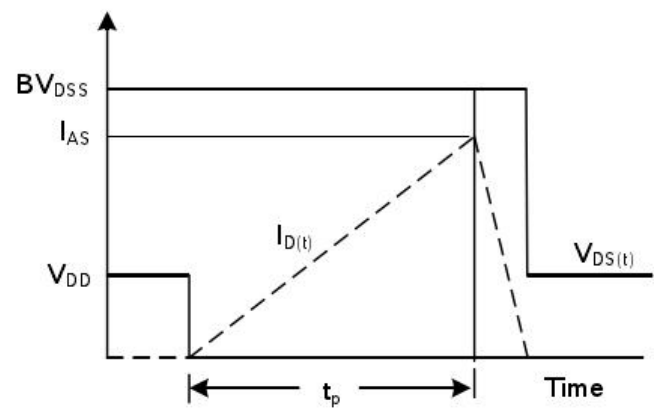

**Unclamped Inductive Switching Waveforms**

## RATING AND CHARACTERISTIC CURVES

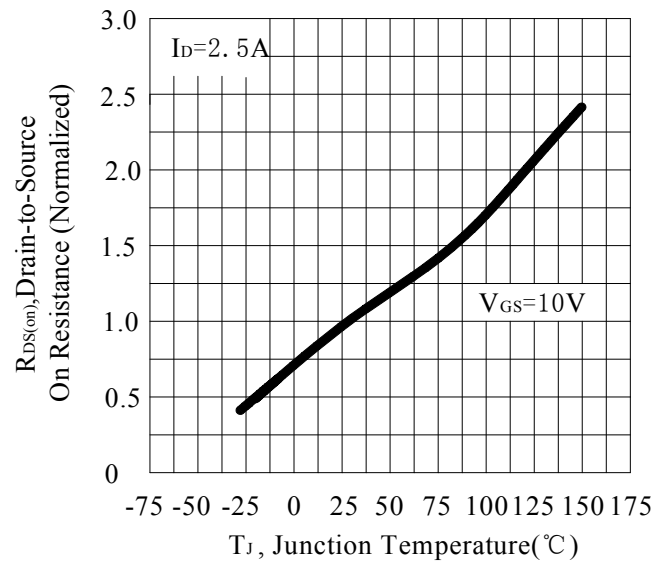
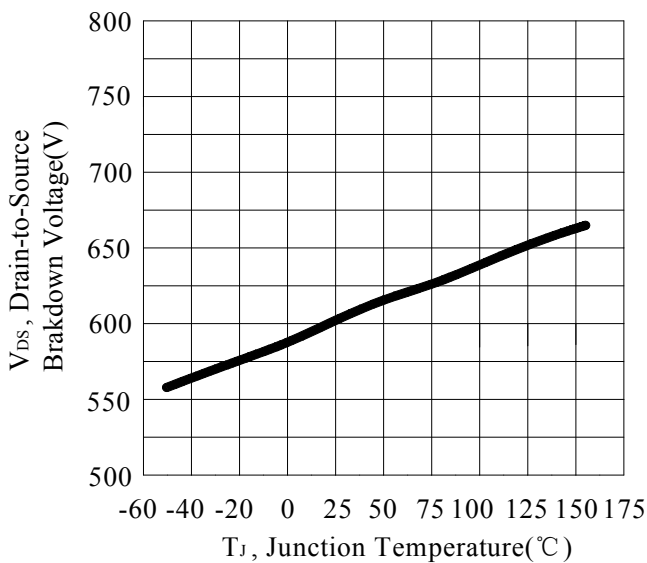
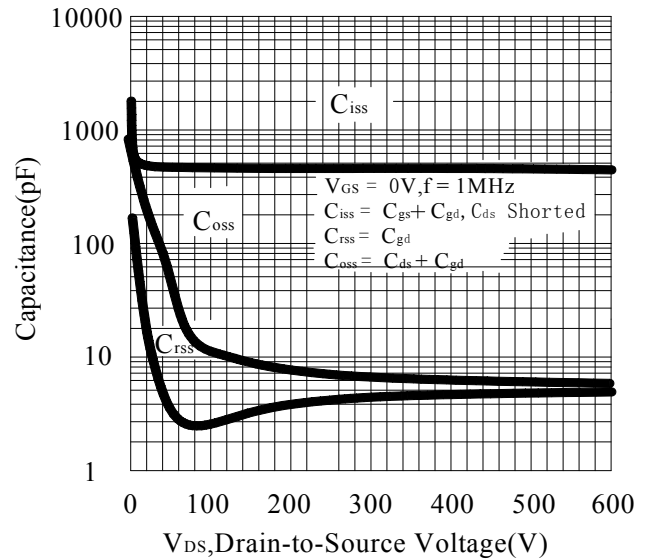
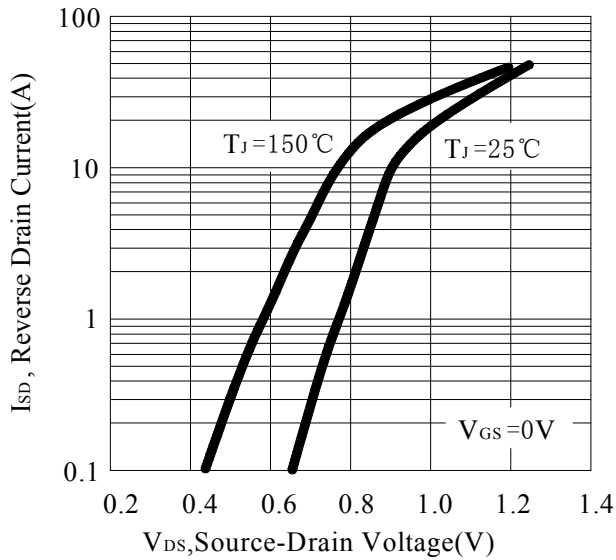
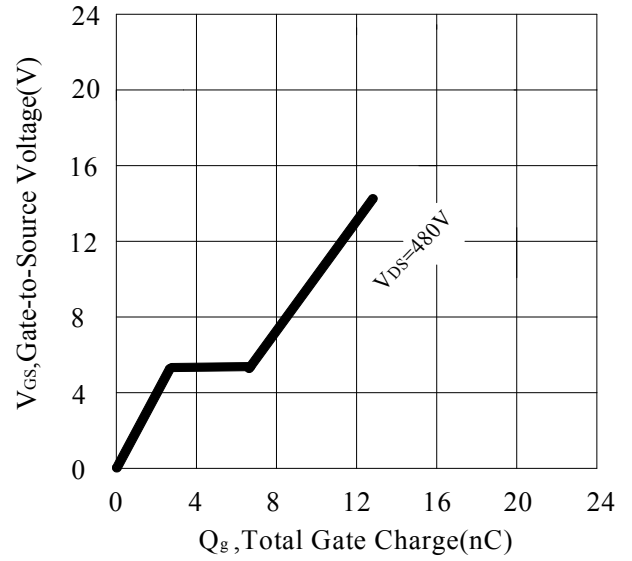
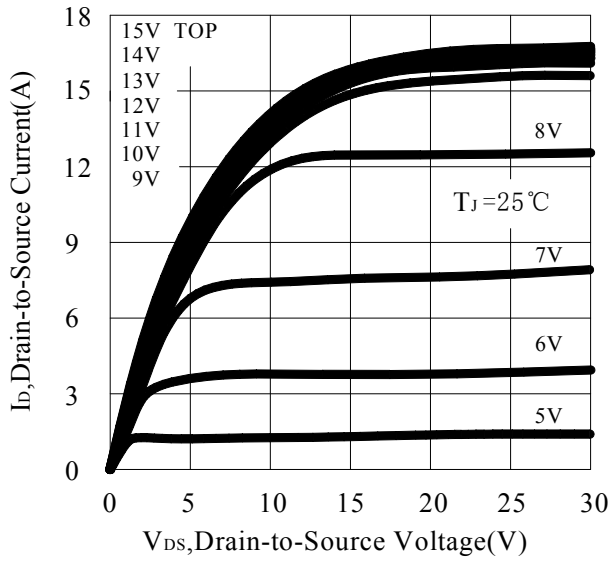

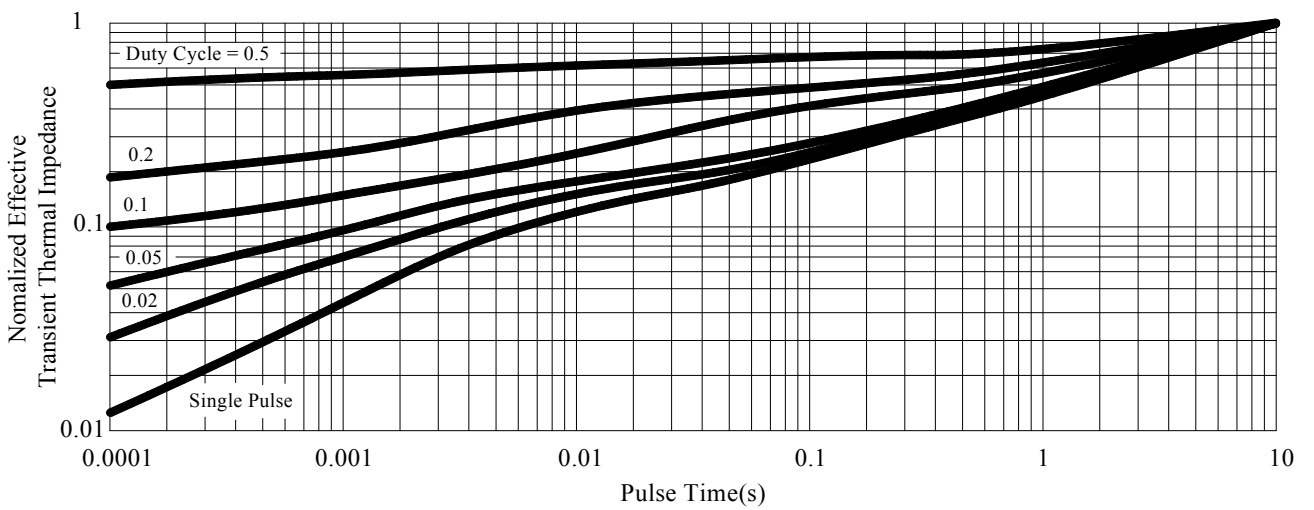
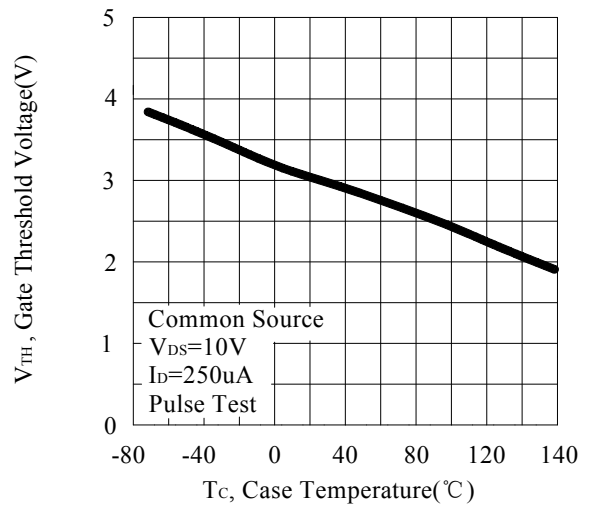
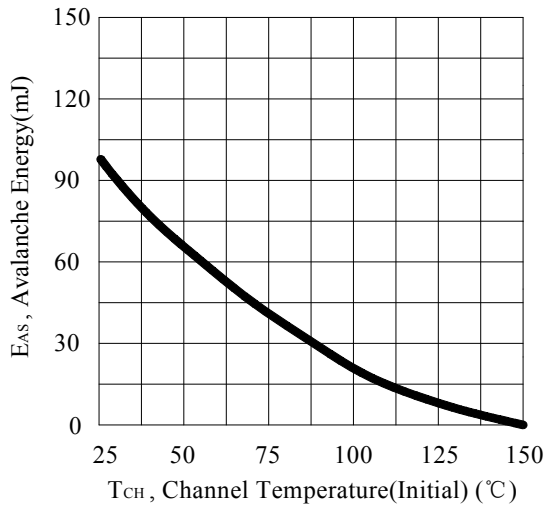
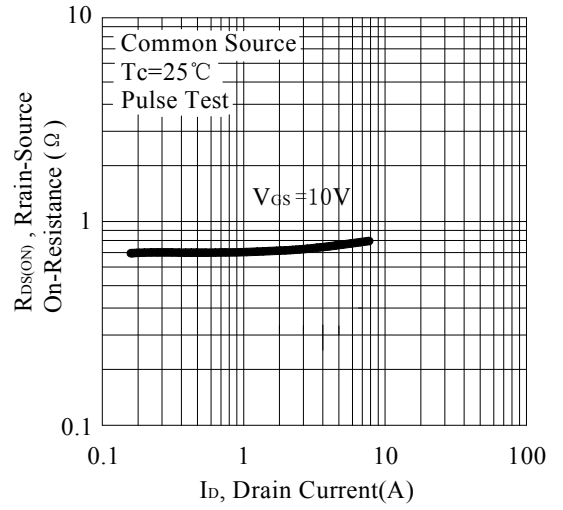
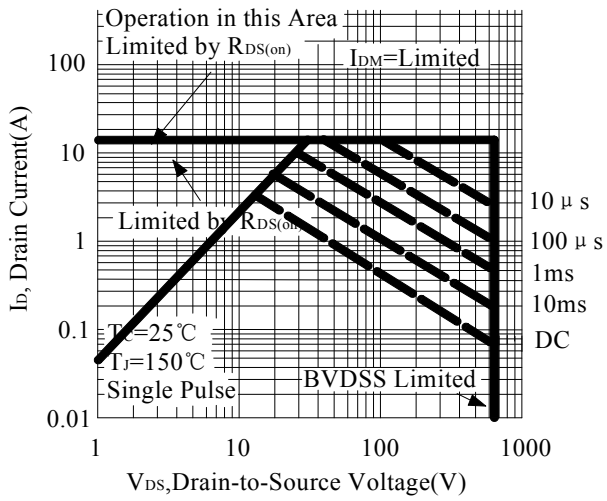

## PACKAGE OUTLINE DIMENSIONS

### TO-252

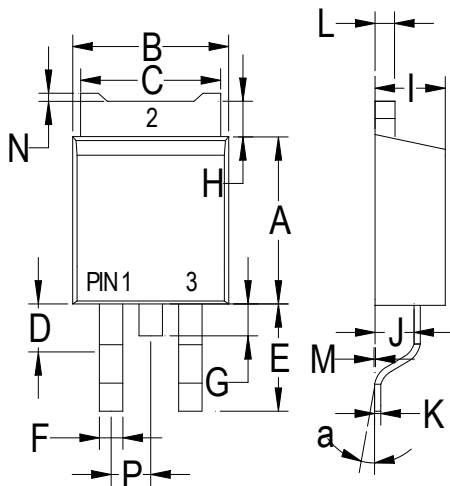

TO-252		
Dim	Min	Max
A	.230 (5.85)	.246 (6.25)
B	.250 (6.35)	.264 (6.75)
C	.207 (5.27)	.218 (5.54)
D	.037 (0.93)	.045 (1.14)
E	.106 (2.70)	.138 (3.50)
F	.028 (0.72)	.033 (0.84)
G	.024 (0.60)	.041 (1.05)
H	.028 (0.72)	.043 (1.10)
I	.085 (2.15)	.096 (2.45)
J	.037 (0.95)	.047 (1.20)
K	.018 (0.45)	.026 (0.65)
L	.018 (0.45)	.024 (0.60)
P	.081 (2.05)	.094 (2.40)
M	.000 (0.00)	.006 (0.15)
N	--	.008 (0.20)
a	0°	10°

Dimensions in inches and (millimeters)

## X-ON Electronics

Largest Supplier of Electrical and Electronic Components

*Click to view similar products for [MOSFET](#) category:*

*Click to view products by [Pingwei](#) manufacturer:*

Other Similar products are found below :

[614233C](#) [648584F](#) [MCH3443-TL-E](#) [MCH6422-TL-E](#) [FDPF9N50NZ](#) [FW216A-TL-2W](#) [FW231A-TL-E](#) [APT5010JVR](#) [NTNS3A92PZT5G](#)  
[IRF100S201](#) [JANTX2N5237](#) [2SK2464-TL-E](#) [2SK3818-DL-E](#) [FCA20N60\\_F109](#) [FDZ595PZ](#) [STD6600NT4G](#) [FSS804-TL-E](#) [2SJ277-DL-E](#)  
[2SK1691-DL-E](#) [2SK2545\(Q,T\)](#) [D2294UK](#) [405094E](#) [423220D](#) [MCH6646-TL-E](#) [TPCC8103,L1Q\(CM](#) [367-8430-0972-503](#) [VN1206L](#)  
[424134F](#) [026935X](#) [051075F](#) [SBVS138LT1G](#) [614234A](#) [715780A](#) [NTNS3166NZT5G](#) [751625C](#) [873612G](#) [IRF7380TRHR](#)  
[IPS70R2K0CEAKMA1](#) [RJK60S3DPP-E0#T2](#) [RJK60S5DPK-M0#T0](#) [APT5010JVFR](#) [APT12031JFLL](#) [APT12040JVR](#) [DMN3404LQ-7](#)  
[NTE6400](#) [JANTX2N6796U](#) [JANTX2N6784U](#) [JANTXV2N5416U4](#) [SQM110N05-06L-GE3](#) [SIHF35N60E-GE3](#)