

PS20U80CT&PS20U80FCT

20.0AMPS. SCHOTTKY BARRIER RECTIFIERS

FEATURE

- . High current capability
- . Ultra low forward voltage drop
- . Low power loss, high efficiency
- . High surge capability
- . High temperature soldering guaranteed
260°C /10seconds, 0.25"(6.35mm)from case.

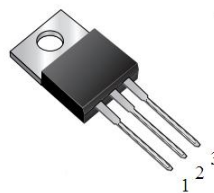

TO-220AB
PS20U80CT

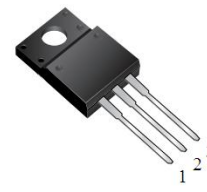

ITO-220AB
PS20U80FCT

MECHANICAL DATA

- . Case: Molded with UL-94 Class V-0 recognized
Flame Retardant Epoxy
- . Mounting position: any

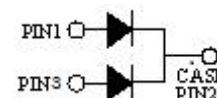

Single phase, half wave, 60Hz, resistive or inductive load.

For capacitive load, derate current by 20%

MAXIMUM RATINGS (T_C=25°C unless otherwise noted)

Parameter	Symbol	PS20U80CT&PS20U80FCT	Units
Maximum Recurrent Peak Reverse Voltage	V_{RRM}	80	V
Maximum RMS Voltage	V_{RMS}	56	V
Maximum DC blocking Voltage	V_{DC}	80	V
Maximum Average Forward Rectified Current <i>Per Leg</i> at T _C =100°C <i>Total device</i>	$I_{F(AV)}$	10.0 20.0	A
Peak Forward Surge Current 8.3ms single half sine-wave superimposed on rated load (JEDEC method) <i>Per Leg</i>	I_{FSM}	150.0	A
Typical Junction Capacitance (Note 1)	C_J	730	pF
Operation Junction Temperature and Storage Temperature	T_J, T_{STG}	-55 to +150	°C
Maximum Mounting torque, M3 or 6-32 srew		1.1N•m (10 lbf•in)	

ELECTRICAL CHARACTERISTICS (T_C=25°C unless otherwise noted)

Parameter	Symbol	Test conditions	Typ	Max	Units	
Forward voltage drop	V_F	$T_J=25\text{ }^\circ\text{C}$	IF= 5.0A	0.48	----	V
			IF=10.0A	0.57	0.65	
		$T_J=125\text{ }^\circ\text{C}$	IF= 5.0A	0.42	----	
			IF=10.0A	0.55	0.63	
Reverse leakage Current	I_R	$T_J=25\text{ }^\circ\text{C}$	VR=80V	----	0.20	mA
		$T_J=125\text{ }^\circ\text{C}$	VR=80V	----	20.0	mA

THERMAL CHARACTERISTICS (T_C=25°C unless otherwise noted)

Parameter	Symbol	PS20U80CT	PS20U80FCT	Units
Typical Thermal Resistance (Note 2)	$R_{(JC)}$	2.0	3.0	°C/W

Notes:

1. Measured at 1.0 MHz and applied reverse voltage of 4.0Vdc
2. Thermal Resistance from Junction to Case

RATING AND CHARACTERISTIC CURVES

FIG.1-TYPICAL FORWARD CURRENT DERATING CURVE

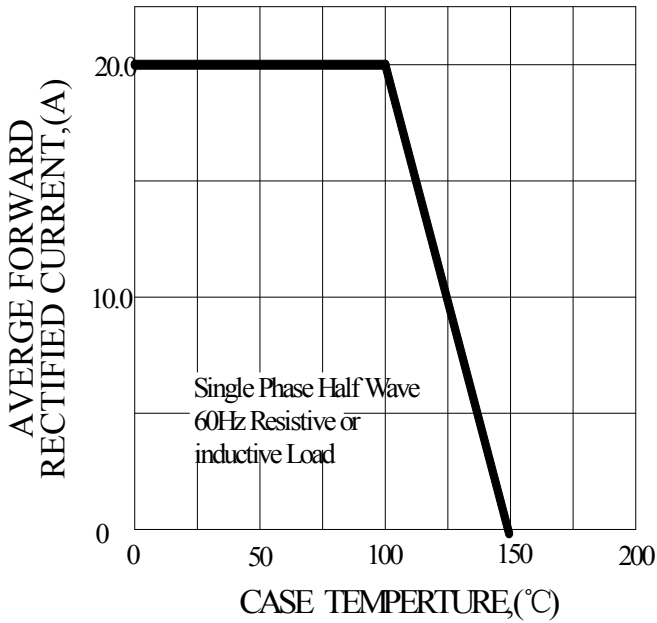

FIG.2-TYPICAL INSTANTANEOUS FORWARD CHARACTERISTICS

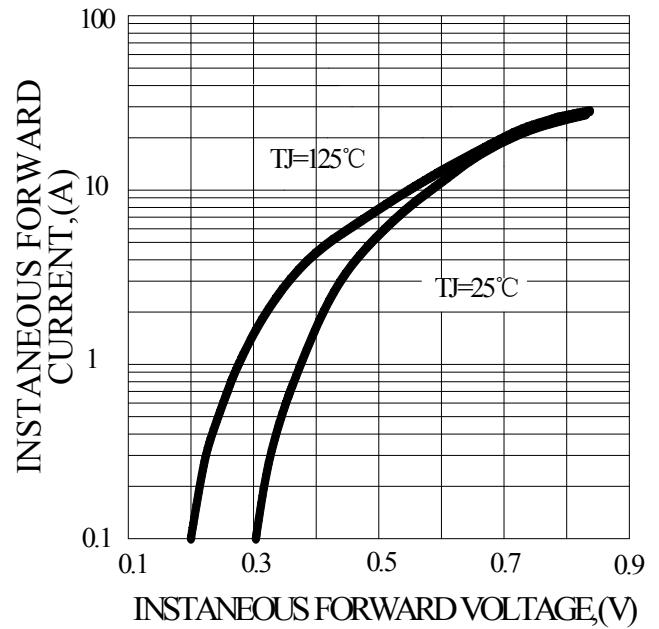

FIG.3-MAXIMUM NON-REPETITIVE FORWARD SURGE CURRENT

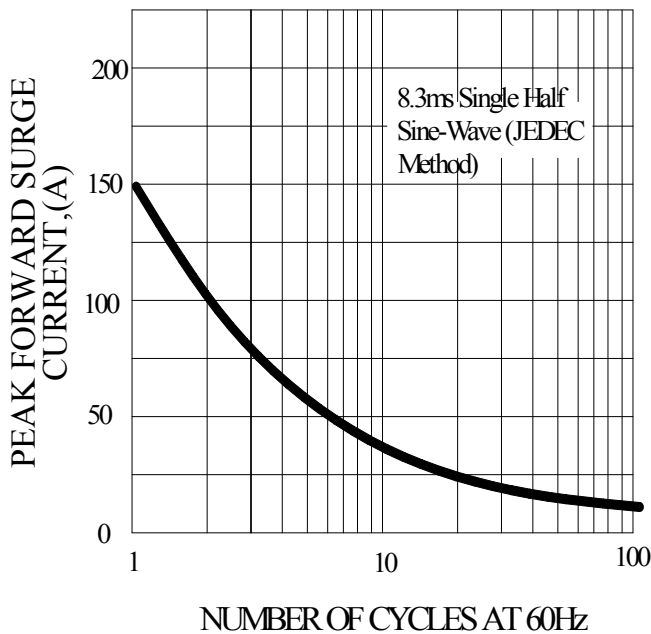
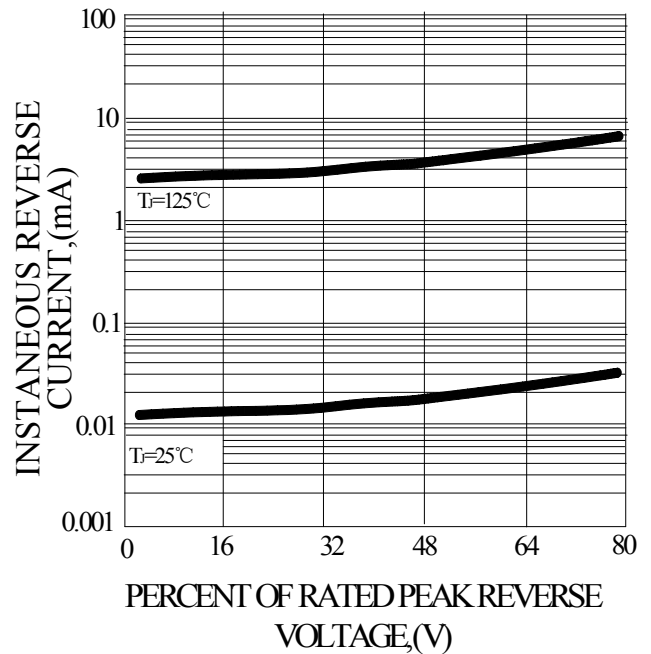
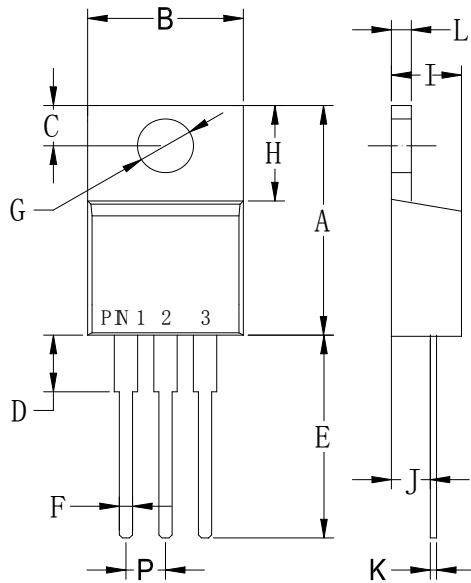

FIG.4-TYPICAL REVERSE CHARACTERISTICS



PACKAGE OUTLINE DIMENSIONS

TO-220AB



TO-220AB		
Dim	Min	Max
A	.573 (14.55)	.603 (15.32)
B	—	.412 (10.5)
C	.103 (2.62)	.113 (2.87)
D	.140 (3.56)	.160 (4.06)
E	.510 (13.0)	.560 (14.3)
F	.027 (0.68)	.037 (0.94)
G	.148 (3.74)	.154 (3.91)
H	.230 (5.84)	.270 (6.86)
I	.175 (4.44)	.185 (4.86)
J	.100 (2.54)	.110 (2.79)
K	.014 (0.35)	.025 (0.64)
L	.045 (1.14)	.055 (1.40)
P	.095 (2.41)	.105 (2.67)

Dimensions in inches and (millimeters)

ITO-220AB

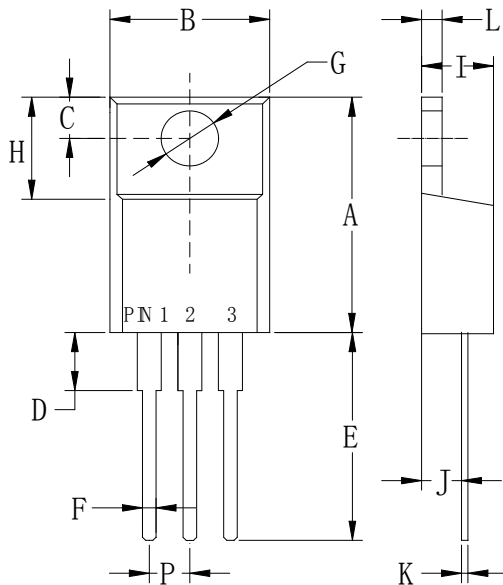

ITO-220AB		
Dim	Min	Max
A	.571 (14.5)	.610 (15.5)
B	.383 (9.72)	.406 (10.3)
C	.110 (2.80)	.126 (3.20)
D	.133 (3.38)	.162 (4.10)
E	.512 (13.0)	.551 (14.0)
F	.028 (0.70)	.035 (0.90)
G	.114 (2.90)	.138 (3.50)
H	.268 (6.80)	.291 (7.40)
I	.162 (4.10)	.185 (4.70)
J	.102 (2.60)	.110 (2.80)
K	.018 (0.45)	.026 (0.65)
L	.097 (2.46)	.113 (2.86)
P	.890 (2.25)	.113 (2.85)

Dimensions in inches and (millimeters)

Marking and packaging illustration

1、Marking

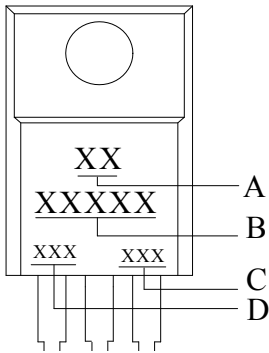

SYMBOL	Explanation
A	Trademark
B	Product Name
C	Date Code
D	Product Information

2、Packaging

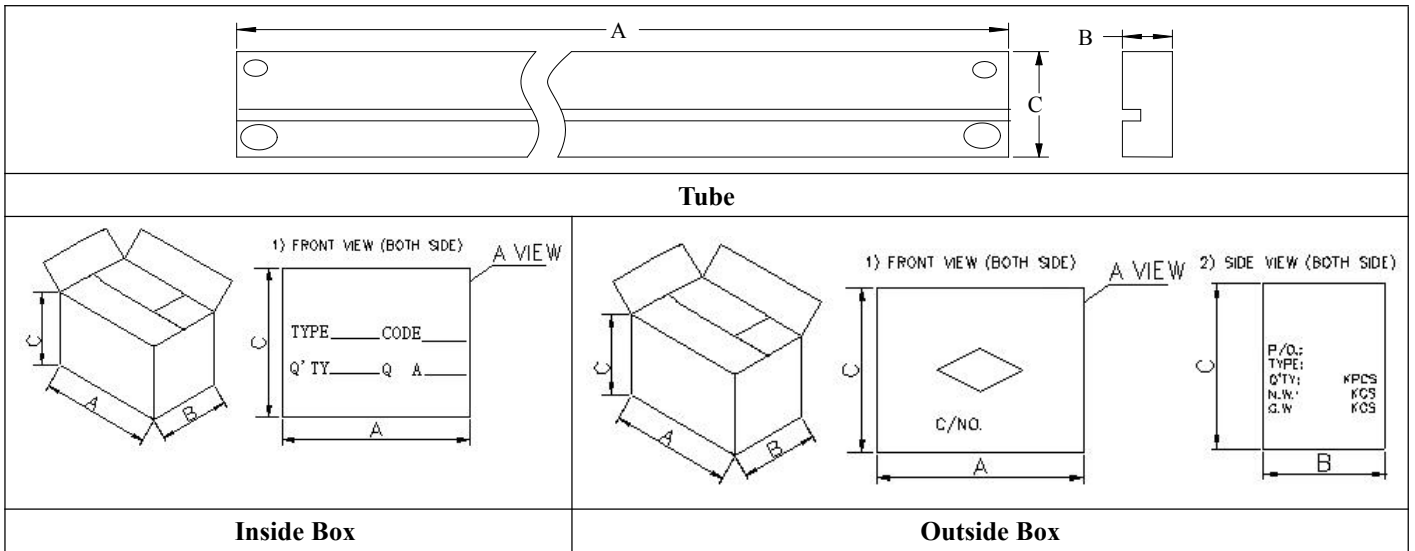

类别	A (mm)	B (mm)	C (mm)
T0-220 Tube (50EA per tube)	530±5	7±0.8	33±1
T0-220 Inside Box (1K per box)	542±5	82±2	78±1
T0-220 outside Box (6K per box)	555±5	285±5	245±5

X-ON Electronics

Largest Supplier of Electrical and Electronic Components

Click to view similar products for [pingwei manufacturer](#):

Other Similar products are found below :

[KBJ1008](#) [SB5150L](#) [P6SMBJ68CA](#) [GBU410](#) [DB207S](#) [KBJ1006](#) [SB5P45](#) [KBJ1010](#) [GBL410](#) [GBU408](#) [PS40U60CT](#) [MBR20200CT](#) [D16-](#)
[DSS16](#) [MUR1040CT](#) [MBR30100CT](#) [MBR20200FCT](#) [MBR20100CT](#) [MBR20150FCT](#) [FR107](#) [GBU806](#) [HBRA10100BCT](#) [SB2200](#)
[MUR1620CTR](#) [SB5150](#) [GBU1006](#) [1N5404](#) [6A2](#) [PS10U100S](#) [GS1G](#) [GBJ2010](#) [GBU606](#) [16N65MF](#) [20N65NF](#) [HER303](#) [6A1](#) [1N5395](#)
[SF16](#) [18N50MF](#) [MBR30100FCT](#) [MUR1640FCT](#) [MBR30200FCT](#) [SS510B](#) [GBU406](#) [GBP206](#) [KBJ406](#) [100N10NF](#) [MBR10200FCT](#)
[GBU808](#) [SS3T10A](#) [PS40U100CT](#)