

Selection diagram

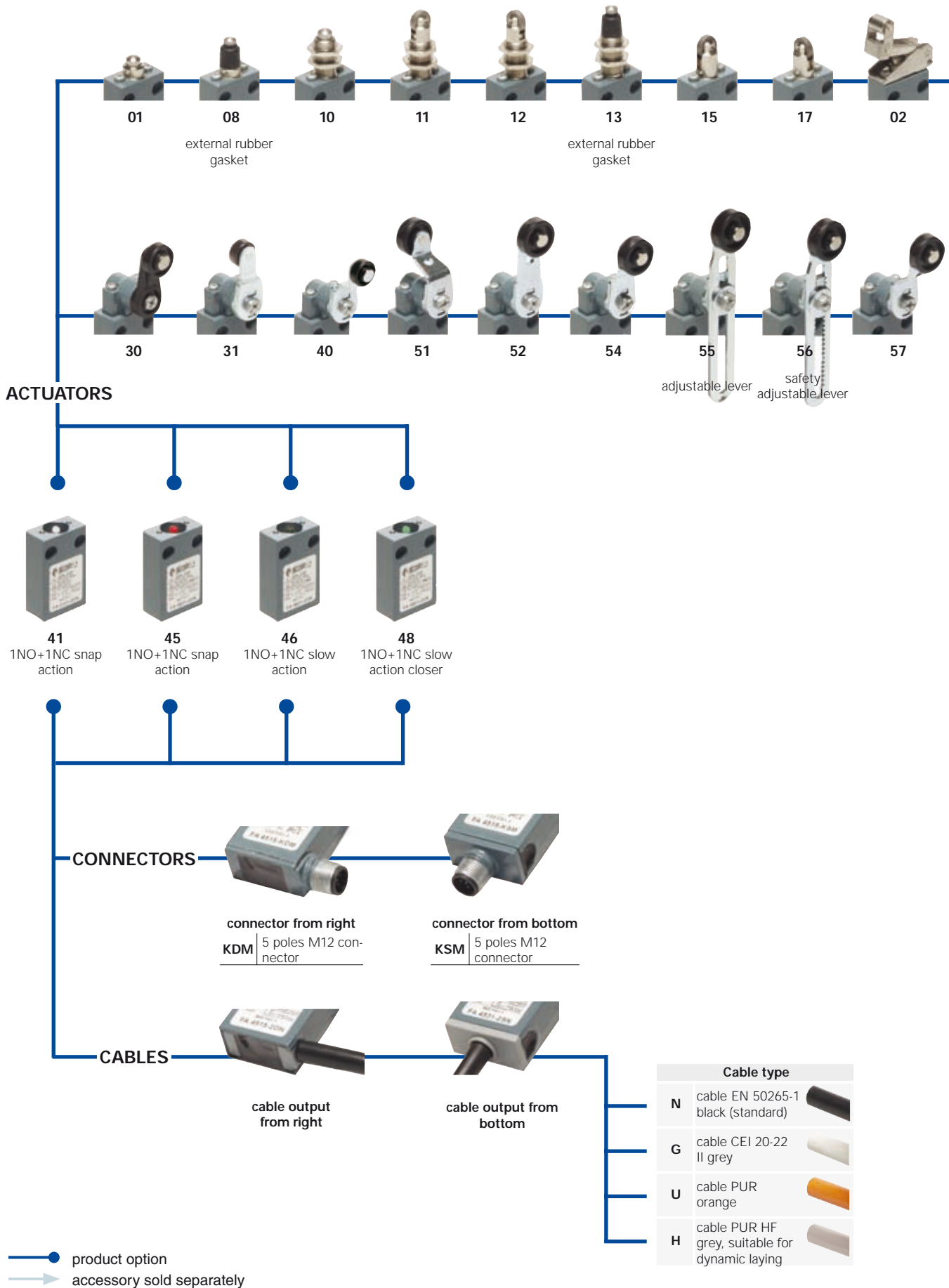

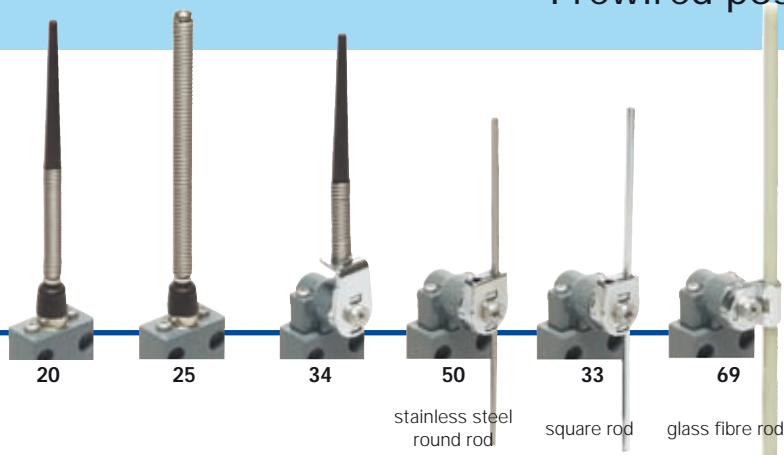

Code structure

Attention! The feasibility of a code number does not mean the effective availability of a product. Please contact our sales office.

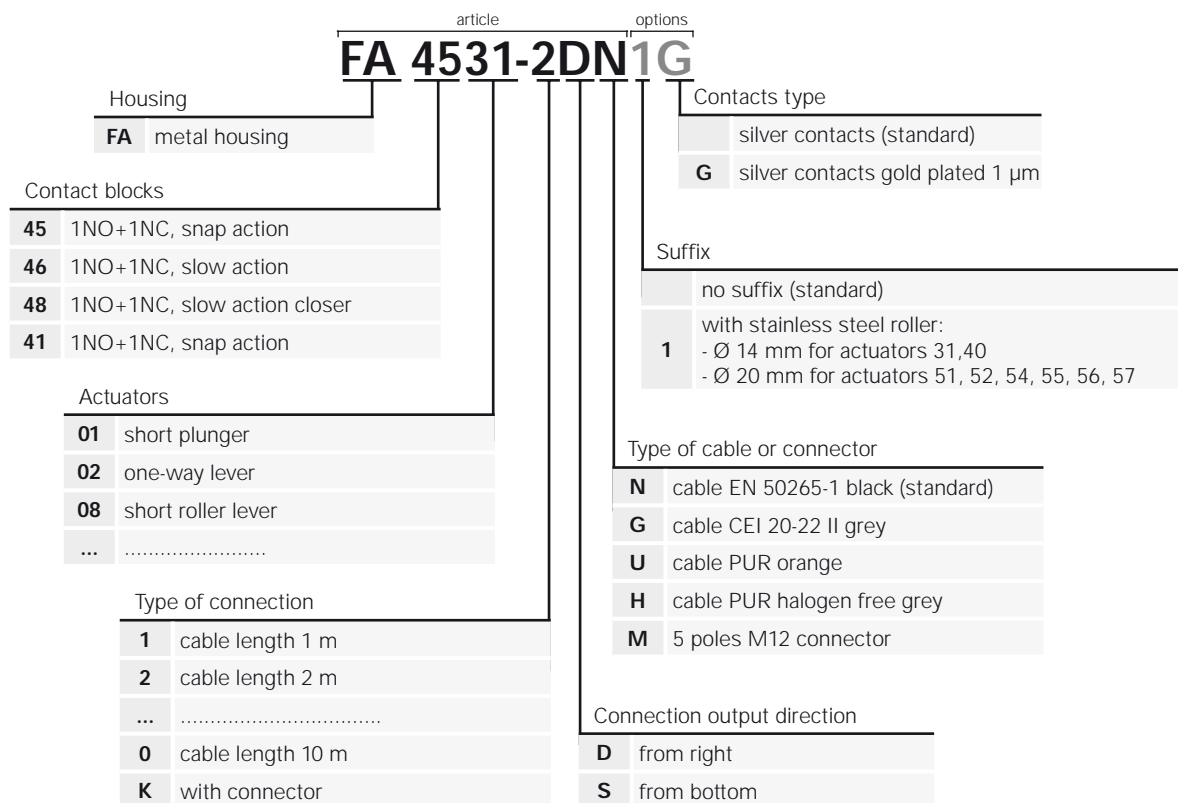



Main data

- Metal housing, cable output from right or from bottom
- 4 integrated cable types available
- Versions with M12 connector from right or from bottom suitable for safety applications ⊕
- Protection degree IP67
- 4 contact blocks available
- 24 actuators available

Markings and quality marks:



Approval IMQ: EI007
 Approval UL: E131787
 Approval UL: 2007010305229997
 Approval ECU: 1010151

Technical data

Housing

Metal housing, coated with baked epoxy powder

Version with cable integrated with 5x 0.75 mm² wires length 2 m, other lengths on request.

Versions with 5 poles M12 integrated connector suitable for safety applications ⊕

Protection degree: IP67

General data

Ambient temperature: See table on page 2/102
 Max operating frequency: 3600 operations cycles¹/hour
 Mechanical endurance: 20 million operations cycles¹
 Assembling position: any
 Vibrations holding: 20 gn (10...500 Hz) according to IEC 60068-2-6
 Shock holding: 50 gn (11 ms) according to IEC 60068-2-27

(1) One operation cycle means two movements, one to close and one to open contacts, as foreseen by IEC 947-5-1 standard.

In conformity with standards:

IEC 60947-5-1, EN 60947-5-1, IEC 60204-1, EN 60204-1, EN 1088, EN ISO 12100-1, EN ISO 12100-2, IEC 529, EN 60529, NFC 63-140, VDE 0660-200, VDE 0113, CENELEC EN 50013.

Approvals:

IEC 60947-5-1, UL 508, GB14048.5-2001

In conformity with requirements requested by:

Low Voltage Directive 2006/95/EC, Machinery Directive 2006/42/EC and Electromagnetic Compatibility 2004/108/EC.

Positive contact opening in conformity with standards:

IEC 60947-5-1, EN 60947-5-1, VDE 0660-206.

Installation for safety applications:

Use only switches marked with the symbol ⊕. The safety circuit must always be connected with the **NC contacts** (normally closed contacts: see "internal connections" on page 2/102) as stated in the **standard EN 60947-5-1, encl. K, par. 2**. The switch must be actuated with **at least up to the positive opening travel** shown in the travels diagrams on page 6/8. The switch must be actuated **at least with the positive opening force**, shown in brackets, underneath each article, near the value of the min. force.

⚠ If not expressly indicated in this chapter, for the right installation and the correct utilization of all articles see requirements indicated from page 6/1 to page 6/8.

Electrical data

Utilization categories

with cable	Thermal current (I _{th}):	10 A	Alternate current: AC15 (50...60 Hz)		
	Rated insulation voltage (U _i):	500 VAC 600 VDC	U _e (V)	120	250
Protection against short circuits:	fuse 10 A 500 V type aM	I _e (A)	6	4	3
Pollution degree:	3	Direct current: DC13			
		U _e (V)	24	125	250
		I _e (A)	2,5	0,55	0,27

with 5 poles M12 connector	Thermal current (I _{th}):	4 A	Alternate current: AC15 (50...60 Hz)		
	Rated insulation voltage (U _i):	250 VAC 300 VDC	U _e (V)	120	250
Protection against short circuits:	fuse 4 A 500 V type gG	I _e (A)	4	4	
Pollution degree:	3	Direct current: DC13			
		U _e (V)	24	125	250
		I _e (A)	2,5	0,55	0,27

Data type approved by IMQ and ECU

Rated insulation voltage (Ui): 500 VAC / 250 VAC (with connector)
 Thermal current (Ith): 10 A / 4 A (with connector)
 Protection against short circuits: fuse 10 A 500 V type aM
 Protection degree: IP67
 MA terminals (seamed clamps)
 Pollution degree 3
 Utilization category: AC15 / DC13 (with connector)
 Operation voltage (Ue): 400 VAC (50 Hz) / 24 VDC (with connector)
 Operation current (Ie): 3 A / 2,5 A (with connector)
 Forms of the contact element: Zb
 Positive opening of contacts on contact block 45, 46, 48
 In conformity with standards: EN60947-1, EN 60947-5-1 and subsequent modifications and completions, fundamental requirements of the Low Voltage Directive 73/23 EEC and subsequent modifications and completions.

Please contact our technical service for the list of type approved products.

Data type approved by UL

Utilization categories Q300 (69 VA, 125-250 VDC)
 A600 (720 VA, 120-600 VAC)
 Data of the housing type 4X, 6 (indoor use only)
 In conformity with standard: UL 508

Please contact our technical service for the list of type approved products.

Adjustable levers

In switches with revolving lever it is possible to adjust the lever with 10° steps for the whole 360° range. The positive movement transmission is always guaranteed thanks to the particular geometrical coupling between the lever and the revolving shaft as prescribed for safety applications by the German standard BG-GS-ET-15.

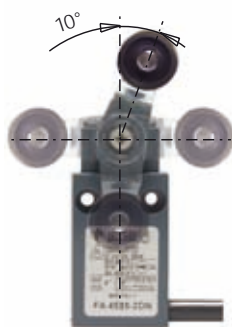

Overturning levers

It's possible to fasten the lever on switches on straight or reverse side, maintaining the positive coupling. In this way it is possible to obtain two different work plans of the lever.



Rotating heads

According to different versions, it is possible to rotate the head in 90° or 180° steps.

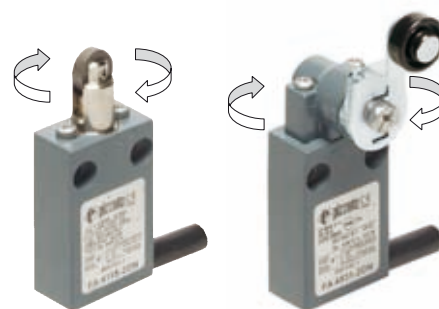

Internal connections

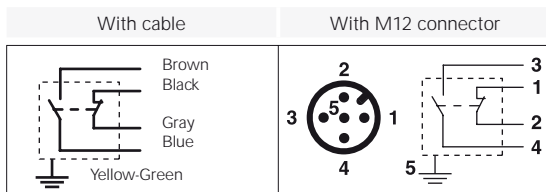

5 poles M12 safety connectors ⊕

The long experience of Pizzato Elettrica has lead to the realization of the first 5-poles connector integrated in a safety switch complying with the requirements of standard IEC 947-5-1. Its high insulation voltage Ui 250 VAC allows to mark it as suitable for safety applications ⊕.

Utilization temperatures and approvals

Cable code	Cable features	Switches FA series standard versions								Available on request				Approvals of switches with integrated cable	
		Fixed laying cable		Dynamic laying cable		Fixed laying cable		Dynamic laying cable		Fixed laying cable		Dynamic laying cable			
		Tmin	Tmax	Tmin	Tmax	Tmin	Tmax	Tmin	Tmax	Tmin	Tmax	Tmin	Tmax		
N	PVC H05VV-F, fixed laying Not spreading the flame EN 50265-2-1	-25 °C	+70 °C	-	-	-	-	-	-	-	-	-	-	-	CE, IMQ, UL, CCC
G	PVC S05VV-F, fixed laying Not flame-spreading CEI 20-22 II	-25 °C	+70 °C	-	-	-	-	-	-	-	-	-	-	-	CE
U	Polyurethane H05BQ-F, fixed laying Oil-resistant IEC 60811-2-1	-25 °C	+70 °C	-	-	-35 °C	+80 °C	-	-	-	-	-	-	-	CE, IMQ, CCC
H	Polyurethane without halogens, dynamic laying Without halogens IEC 60754-1 Oil-resistant IEC 60811-2-1 Self-extinguishing IEC 60332-1, IEC 60332-2 Not flame-spreading IEC 60332-3 Gas emission reduced IEC 61034-1 Copper class 6 (IEC 228)	-25 °C	+80 °C	-25 °C	+80 °C	-35 °C	+80 °C	-35 °C	+80 °C	-35 °C	+80 °C	-35 °C	+80 °C	-	CE, UL

Connector code	Connector features	Switches FA series standard versions		Available on request		Approvals of switches with integrated connector
		Tmin	Tmax	Tmin	Tmax	
K	5 poles M12 connector	-25 °C	+80 °C	-35 °C	+80 °C	CE, IMQ, UL, CCC

Contacts type:

- R = snap action
- L = slow action
- LA = slow action closer

It does not switch It switches

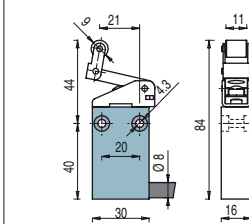
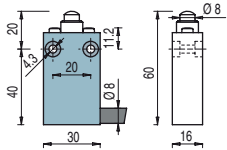

With external rubber gasket

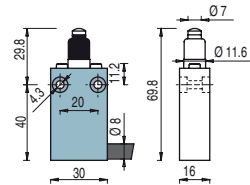

Fixed only by threaded head

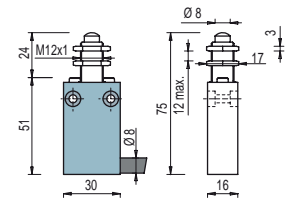

Contact blocks

45	R	FA 4501-2DN	➔	1NO+1NC	FA 4502-2DN	➔	1NO+1NC	FA 4508-2DN	➔	1NO+1NC	FA 4510-2DN	➔	1NO+1NC
46	L	FA 4601-2DN	➔	1NO+1NC	FA 4602-2DN	➔	1NO+1NC	FA 4608-2DN	➔	1NO+1NC	FA 4610-2DN	➔	1NO+1NC
48	LA	FA 4801-2DN	➔	1NO+1NC	FA 4802-2DN	➔	1NO+1NC	FA 4808-2DN	➔	1NO+1NC	FA 4810-2DN	➔	1NO+1NC
41	R	FA 4101-2DN		1NO+1NC	FA 4102-2DN		1NO+1NC	FA 4108-2DN		1NO+1NC	FA 4110-2DN		1NO+1NC
Max speed	page 6/7 - type 4			page 6/7 - type 3			page 6/7 - type 4			page 6/7 - type 4			
Min. force	10 N (25 N ➔)			5 N (25 N ➔)			10 N (25 N ➔)			10 N (25 N ➔)			
Travel diagrams	page 6/8 - group 1			page 6/8 - group 2			page 6/8 - group 1			page 6/8 - group 1			

Fixed only by threaded head

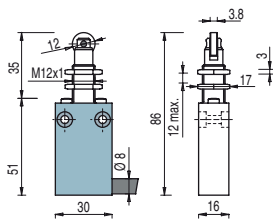

Fixed only by threaded head

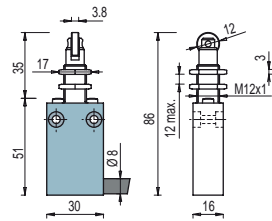

With external rubber gasket

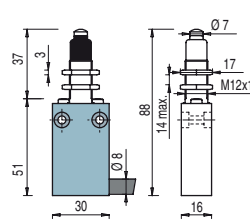

Ø 12 mm stainless steel roller

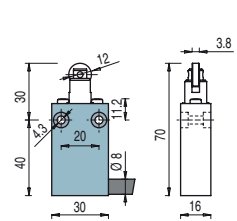

Contact blocks

45	R	FA 4511-2DN	➔	1NO+1NC	FA 4512-2DN	➔	1NO+1NC	FA 4513-2DN	➔	1NO+1NC	FA 4515-2DN	➔	1NO+1NC
46	L	FA 4611-2DN	➔	1NO+1NC	FA 4612-2DN	➔	1NO+1NC	FA 4613-2DN	➔	1NO+1NC	FA 4615-2DN	➔	1NO+1NC
48	LA	FA 4811-2DN	➔	1NO+1NC	FA 4812-2DN	➔	1NO+1NC	FA 4813-2DN	➔	1NO+1NC	FA 4815-2DN	➔	1NO+1NC
41	R	FA 4111-2DN		1NO+1NC	FA 4112-2DN		1NO+1NC	FA 4113-2DN		1NO+1NC	FA 4115-2DN		1NO+1NC
Max speed	page 6/7 - type 2			page 6/7 - type 2			page 6/7 - type 4			page 6/7 - type 2			
Min. force	10 N (25 N ➔)			10 N (25 N ➔)			10 N (25 N ➔)			10 N (25 N ➔)			
Travel diagrams	page 6/8 - group 1			page 6/8 - group 1			page 6/8 - group 1			page 6/8 - group 1			

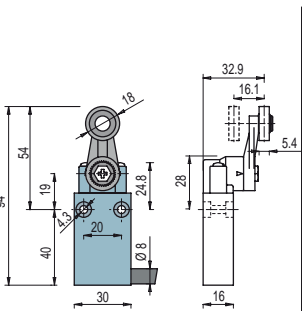
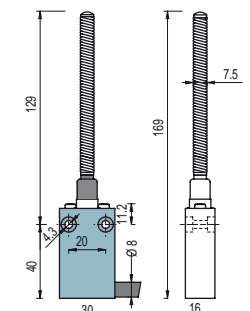
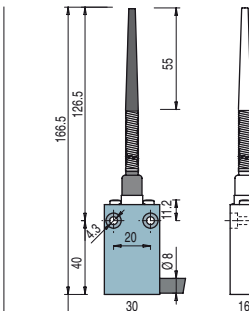
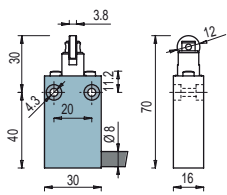

Contact blocks

45	R	FA 4517-2DN	➔	1NO+1NC	FA 4520-2DN		1NO+1NC	FA 4525-2DN		1NO+1NC	FA 4530-2DN	➔	1NO+1NC
46	L	FA 4617-2DN	➔	1NO+1NC	FA 4820-2DN		1NO+1NC	FA 4825-2DN		1NO+1NC	FA 4630-2DN	➔	1NO+1NC
48	LA	FA 4817-2DN	➔	1NO+1NC	FA 4120-2DN		1NO+1NC	FA 4125-2DN		1NO+1NC	FA 4830-2DN	➔	1NO+1NC
41	R	FA 4117-2DN		1NO+1NC	FA 4120-2DN		1NO+1NC	FA 4125-2DN		1NO+1NC	FA 4130-2DN		1NO+1NC
Max speed	page 6/7 - type 2			1 m/s			1 m/s			page 6/7 - type 1			
Min. force	10 N (25 N ➔)			0,07 Nm			0,07 Nm			0,03 Nm (0,25 Nm ➔)			
Travel diagrams	page 6/8 - group 1			page 6/8 - group 3			page 6/8 - group 3			page 6/8 - group 4			

Outline dimensions with cable output from right or from bottom

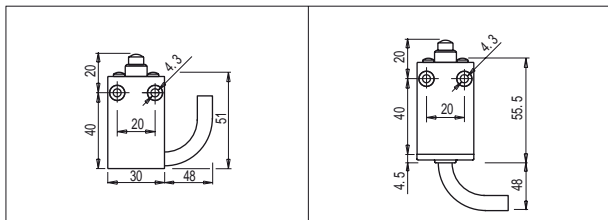

Items with code on the green background are available in stock

Contacts type: R = snap action L = slow action LA = slow action closer	With stainless steel roller on request 	3x3 mm square rod 		With stainless steel roller on request
Contact blocks				
45 R	FA 4531-2DN \rightarrow 1NO+1NC	FA 4533-2DN 1NO+1NC	FA 4534-2DN 1NO+1NC	FA 4540-2DN \rightarrow 1NO+1NC
46 L	FA 4631-2DN \rightarrow 1NO+1NC	FA 4633-2DN 1NO+1NC	FA 4634-2DN 1NO+1NC	FA 4640-2DN \rightarrow 1NO+1NC
48 LA	FA 4831-2DN \rightarrow 1NO+1NC	FA 4833-2DN 1NO+1NC	FA 4834-2DN 1NO+1NC	FA 4840-2DN \rightarrow 1NO+1NC
41 R	FA 4131-2DN 1NO+1NC	FA 4133-2DN 1NO+1NC	FA 4134-2DN 1NO+1NC	FA 4140-2DN 1NO+1NC
Max speed	page 6/7 - type 1	1,5 m/s	1,5 m/s	page 6/7 - type 1
Min. force	0,03 Nm (0,25 Nm \rightarrow)	0,03 Nm	0,03 Nm	0,03 Nm (0,25 Nm \rightarrow)
Travel diagrams	page 6/8 - group 4	page 6/8 - group 4	page 6/8 - group 4	page 6/8 - group 4

	\varnothing 3 mm stainless steel round rod 	With stainless steel roller on request 	With stainless steel roller on request 	With stainless steel roller on request
Contact blocks				
45 R	FA 4550-2DN 1NO+1NC	FA 4551-2DN \rightarrow 1NO+1NC	FA 4552-2DN \rightarrow 1NO+1NC	FA 4554-2DN \rightarrow 1NO+1NC
46 L	FA 4650-2DN 1NO+1NC	FA 4651-2DN \rightarrow 1NO+1NC	FA 4652-2DN \rightarrow 1NO+1NC	FA 4654-2DN \rightarrow 1NO+1NC
48 LA	FA 4850-2DN 1NO+1NC	FA 4851-2DN \rightarrow 1NO+1NC	FA 4852-2DN \rightarrow 1NO+1NC	FA 4854-2DN \rightarrow 1NO+1NC
41 R	FA 4150-2DN 1NO+1NC	FA 4151-2DN 1NO+1NC	FA 4152-2DN 1NO+1NC	FA 4154-2DN 1NO+1NC
Max speed	1,5 m/s	page 6/7 - type 1	page 6/7 - type 1	page 6/7 - type 1
Min. force	0,03 Nm	0,03 Nm (0,25 Nm \rightarrow)	0,03 Nm (0,25 Nm \rightarrow)	0,03 Nm (0,25 Nm \rightarrow)
Travel diagrams	page 6/8 - group 4	page 6/8 - group 4	page 6/8 - group 4	page 6/8 - group 4

	With stainless steel roller on request 	With stainless steel roller on request 	With stainless steel roller on request 	Glass fibre rod
Contact blocks				
45 R	FA 4555-2DN \rightarrow ⁽¹⁾ 1NO+1NC	FA 4556-2DN \rightarrow 1NO+1NC	FA 4557-2DN \rightarrow 1NO+1NC	FA 4569-2DN 1NO+1NC
46 L	FA 4655-2DN \rightarrow ⁽¹⁾ 1NO+1NC	FA 4656-2DN \rightarrow 1NO+1NC	FA 4657-2DN \rightarrow 1NO+1NC	FA 4669-2DN 1NO+1NC
48 LA	FA 4855-2DN \rightarrow ⁽¹⁾ 1NO+1NC	FA 4856-2DN \rightarrow 1NO+1NC	FA 4857-2DN \rightarrow 1NO+1NC	FA 4869-2DN 1NO+1NC
41 R	FA 4155-2DN 1NO+1NC	FA 4156-2DN 1NO+1NC	FA 4157-2DN 1NO+1NC	FA 4169-2DN 1NO+1NC
Max speed	page 6/7 - type 1	page 6/7 - type 1	page 6/7 - type 1	1,5 m/s
Min. force	0,03 Nm (0,25 Nm \rightarrow)	0,03 Nm (0,25 Nm \rightarrow)	0,03 Nm (0,25 Nm \rightarrow)	0,03 Nm
Travel diagrams	page 6/8 - group 4	page 6/8 - group 4	page 6/8 - group 4	page 6/8 - group 4

Accessories

Article	Description
VF D16	Spacers for FA-FF series



By interposing spacers between the switches, it is possible to join two or more prewired switches, preventing them from moving one against the other.
10 pcs packs

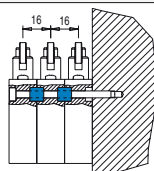

⁽¹⁾ Positive opening only with lever adjusted on the max. See page 2/51

Contacts type:

- R = snap action
- L = slow action
- LA = slow action closer

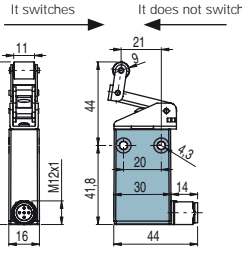
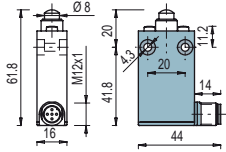

With external rubber gasket

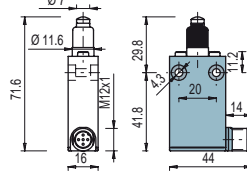

Fixed only by threaded head

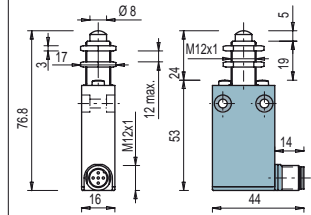

Contact blocks

45	R	FA 4501-KDM	⊕	1NO+1NC
46	L	FA 4601-KDM	⊕	1NO+1NC
48	LA	FA 4801-KDM	⊕	1NO+1NC
41	R	FA 4101-KDM		1NO+1NC
Max speed		page 6/7 - type 4		
Min. force		10 N (25 N ⊕)		
Travel diagrams		page 6/8 - group 1		

Fixed only by threaded head

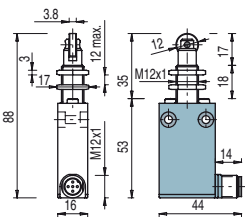

Fixed only by threaded head

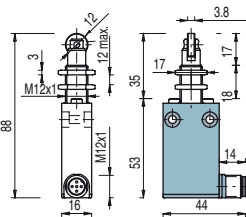

With external rubber gasket

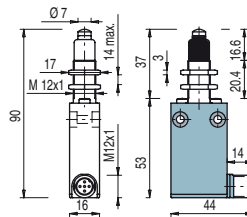

Ø 12 mm stainless steel roller

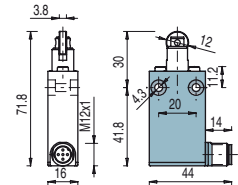

Contact blocks

45	R	FA 4511-KDM	⊕	1NO+1NC
46	L	FA 4611-KDM	⊕	1NO+1NC
48	LA	FA 4811-KDM	⊕	1NO+1NC
41	R	FA 4111-KDM		1NO+1NC
Max speed		page 6/7 - type 2		
Min. force		10 N (25 N ⊕)		
Travel diagrams		page 6/8 - group 1		

Ø 12 mm stainless steel roller

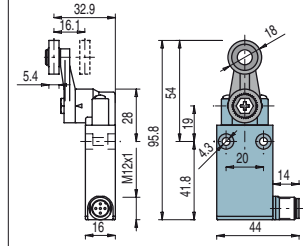
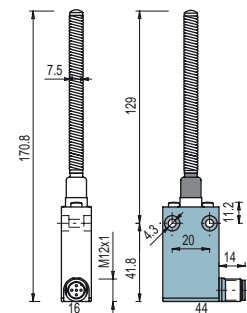
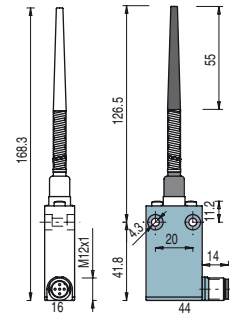
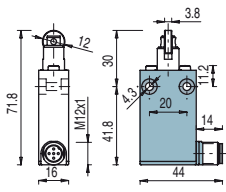

Contact blocks

45	R	FA 4517-KDM	⊕	1NO+1NC
46	L	FA 4617-KDM	⊕	1NO+1NC
48	LA	FA 4817-KDM	⊕	1NO+1NC
41	R	FA 4117-KDM		1NO+1NC
Max speed		page 6/7 - type 2		
Min. force		10 N (25 N ⊕)		
Travel diagrams		page 6/8 - group 1		

FA 4520-KDM	1NO+1NC
FA 4820-KDM	1NO+1NC
FA 4120-KDM	1NO+1NC

FA 4525-KDM	1NO+1NC
FA 4825-KDM	1NO+1NC
FA 4125-KDM	1NO+1NC

FA 4530-KDM	⊕	1NO+1NC
FA 4630-KDM	⊕	1NO+1NC
FA 4830-KDM	⊕	1NO+1NC
FA 4130-KDM		1NO+1NC

Outline dimensions with M12 connector output from right or from bottom

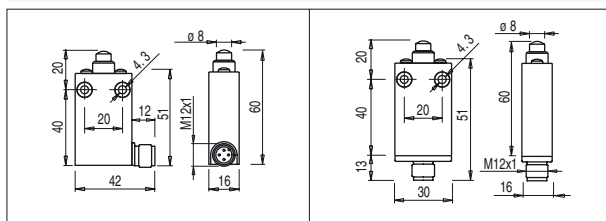

Items with code on the green background are available in stock

Contacts type: R = snap action L = slow action LA = slow action closer	With stainless steel roller on request	3x3 mm square rod		With stainless steel roller on request
Contact blocks	FA 4531-KDM R 1NO+1NC	FA 4533-KDM 1NO+1NC	FA 4534-KDM 1NO+1NC	FA 4540-KDM R 1NO+1NC
	FA 4631-KDM L 1NO+1NC	FA 4633-KDM 1NO+1NC	FA 4634-KDM 1NO+1NC	FA 4640-KDM L 1NO+1NC
	FA 4831-KDM LA 1NO+1NC	FA 4833-KDM 1NO+1NC	FA 4834-KDM 1NO+1NC	FA 4840-KDM LA 1NO+1NC
	FA 4131-KDM R 1NO+1NC	FA 4133-KDM 1NO+1NC	FA 4134-KDM 1NO+1NC	FA 4140-KDM R 1NO+1NC
Max speed	page 6/7 - type 1	1,5 m/s	1,5 m/s	page 6/7 - type 1
Min. force	0,03 Nm (0,25 Nm R)	0,03 Nm	0,03 Nm	0,03 Nm (0,25 Nm R)
Travel diagrams	page 6/8 - group 4	page 6/8 - group 4	page 6/8 - group 4	page 6/8 - group 4

	Ø 3 mm stainless steel round rod	With stainless steel roller on request	With stainless steel roller on request	With stainless steel roller on request
Contact blocks	FA 4550-KDM R 1NO+1NC	FA 4551-KDM R 1NO+1NC	FA 4552-KDM R 1NO+1NC	FA 4554-KDM R 1NO+1NC
	FA 4650-KDM L 1NO+1NC	FA 4651-KDM R 1NO+1NC	FA 4652-KDM R 1NO+1NC	FA 4654-KDM R 1NO+1NC
	FA 4850-KDM LA 1NO+1NC	FA 4851-KDM R 1NO+1NC	FA 4852-KDM R 1NO+1NC	FA 4854-KDM R 1NO+1NC
	FA 4150-KDM R 1NO+1NC	FA 4151-KDM 1NO+1NC	FA 4152-KDM 1NO+1NC	FA 4154-KDM 1NO+1NC
Max speed	1,5 m/s	page 6/7 - type 1	page 6/7 - type 1	page 6/7 - type 1
Min. force	0,03 Nm	0,03 Nm (0,25 Nm R)	0,03 Nm (0,25 Nm R)	0,03 Nm (0,25 Nm R)
Travel diagrams	page 6/8 - group 4	page 6/8 - group 4	page 6/8 - group 4	page 6/8 - group 4

	With stainless steel roller on request	With stainless steel roller on request	With stainless steel roller on request	Glass fibre rod
Contact blocks	FA 4555-KDM R 1NO+1NC	FA 4556-KDM R 1NO+1NC	FA 4557-KDM R 1NO+1NC	FA 4569-KDM 1NO+1NC
	FA 4655-KDM L 1NO+1NC	FA 4656-KDM R 1NO+1NC	FA 4657-KDM 1NO+1NC	FA 4669-KDM 1NO+1NC
	FA 4855-KDM LA 1NO+1NC	FA 4856-KDM R 1NO+1NC	FA 4857-KDM R 1NO+1NC	FA 4869-KDM 1NO+1NC
	FA 4155-KDM R 1NO+1NC	FA 4156-KDM 1NO+1NC	FA 4157-KDM 1NO+1NC	FA 4169-KDM 1NO+1NC
Max speed	page 6/7 - type 1	page 6/7 - type 1	page 6/7 - type 1	1,5 m/s
Min. force	0,03 Nm (0,25 Nm R)	0,03 Nm (0,25 Nm R)	0,03 Nm (0,25 Nm R)	0,03 Nm
Travel diagrams	page 6/8 - group 4	page 6/8 - group 4	page 6/8 - group 4	page 6/8 - group 4

Accessories

Article	Description
VF D16	Spacers for FA-FF series



By interposing spacers between the switches, it is possible to join two or more prewired switches, preventing them from moving one against the other.
10 pcs packs

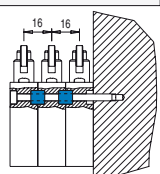

Article	Description
VF CA...M	Female wired connectors



General data:
 - Self locking ring nut
 - High flexibility wire suitable for dynamic laying applications (copper class 6)
 - Gold plated contact (resistance < 5 mΩ)
 - Connector body in polyurethane
See page 5/2

X-ON Electronics

Largest Supplier of Electrical and Electronic Components

Click to view similar products for [Limit Switches](#) category:

Click to view products by [Pizzato](#) manufacturer:

Other Similar products are found below :

[5ML1-E1](#) [5ML31](#) [LZG1](#) [LZL1-6C](#) [622EN114-R](#) [622EN18-6](#) [622EN224-6B](#) [622EN230](#) [622EN237-R](#) [622EN69-3](#) [622EN85-RB](#) [MA-10019](#)
[6PA109](#) [7LS51](#) [83547001](#) [83725002](#) [83830001](#) [83840701](#) [83841001](#) [83881140](#) [8AS42](#) [8LS10](#) [8LS125-4PG](#) [8LS152-4PGN20](#) [914CE16-](#)
[3A](#) [914CE3-3L1](#) [915PA10](#) [91MCE16-P2O](#) [924CE16-Y3](#) [924CE1-S6](#) [924CE1-T25A](#) [924CE1-T3](#) [924CE1-T9A](#) [924CE2-T9](#) [924CE31-Y20-](#)
[X5](#) [924CE31-Y3L1](#) [GL-10054](#) [GLDB03C-6](#) [GLZ324](#) [H3141CAKAA](#) [RDI-G-L5B](#) [DD-10000](#) [DT-2R3-A7](#) [14CE16-3N28](#) [14CE18-N15](#)
[151ML3-E1](#) [E3102BAAAA](#) [BFL1-AW1-S](#) [1EN329-R](#) [1LS1-4PGN159](#)