

Selection diagram

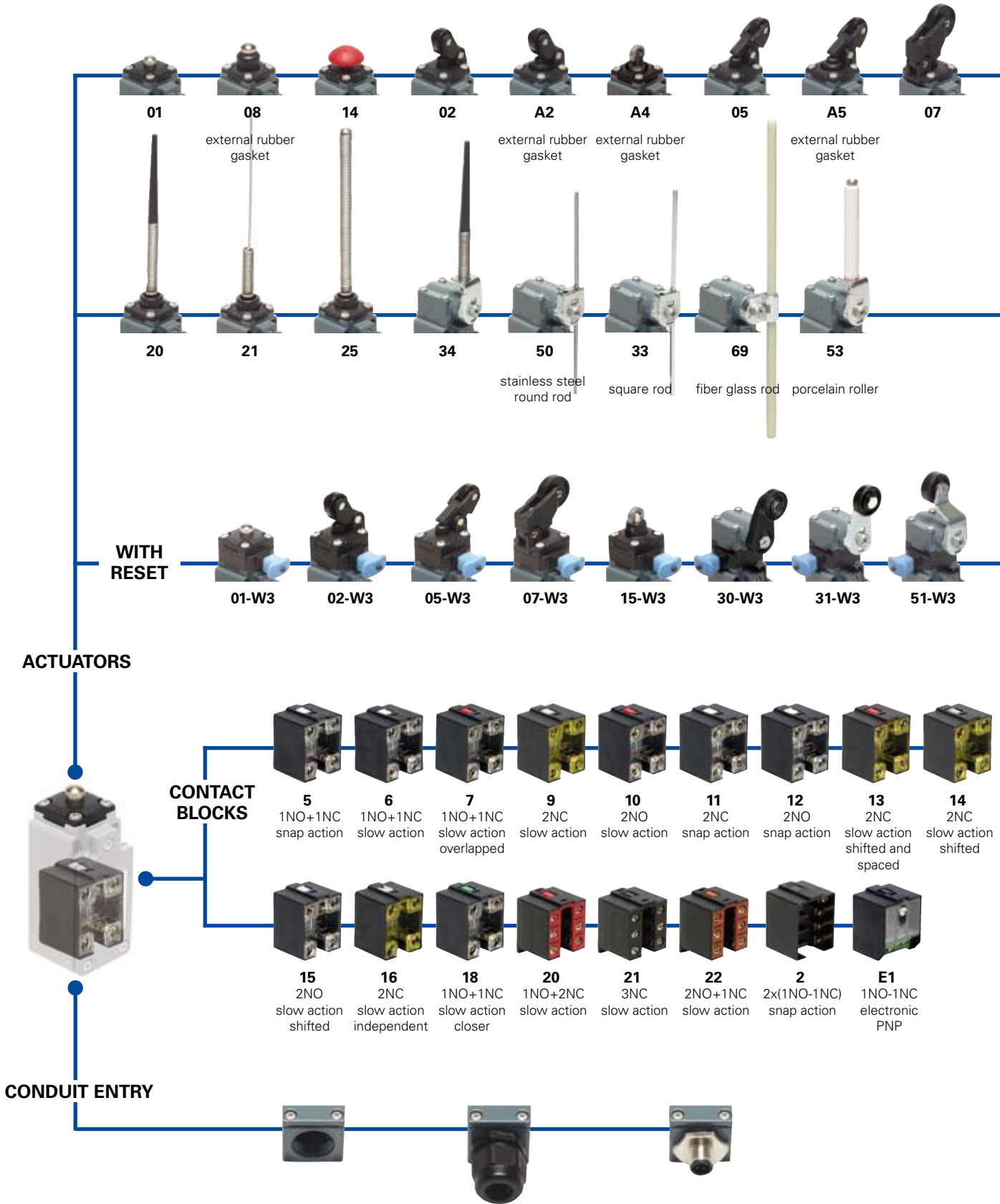

Threaded conduit entry

| | |
|----|--------------------|
| | PG 13,5 (standard) |
| M2 | M20x1,5 |

With assembled cable gland

| | | | |
|---------|---------|---------------------------------|---------------------------------|
| PG 13,5 | K21 | for Ø 6 to Ø 12 mm cables range | |
| | K25 | for Ø 3 to Ø 7 mm cables range | |
| | M20x1,5 | K23 | for Ø 6 to Ø 12 mm cables range |
| | | K27 | for Ø 3 to Ø 7 mm cables range |

With M12 metal connector assembled and wired

| | |
|-----|---------------------|
| K40 | 8 poles from bottom |
| K50 | 5 poles from bottom |

● product option
 → accessory sold separately

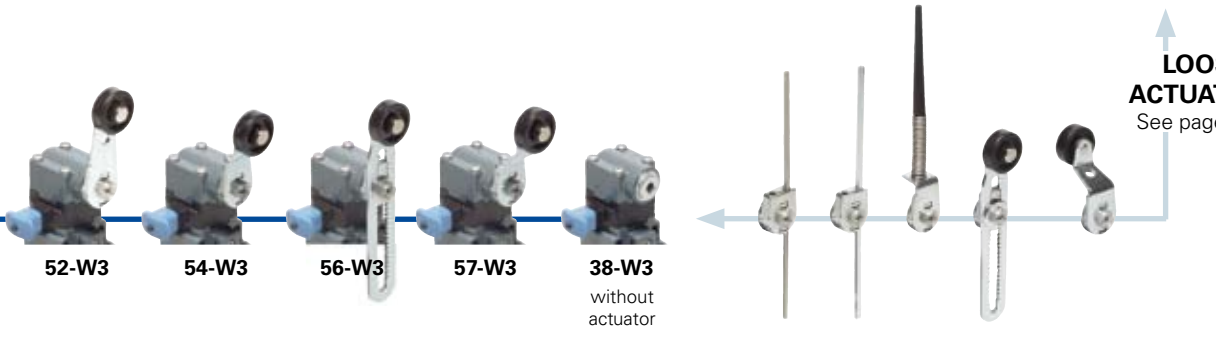
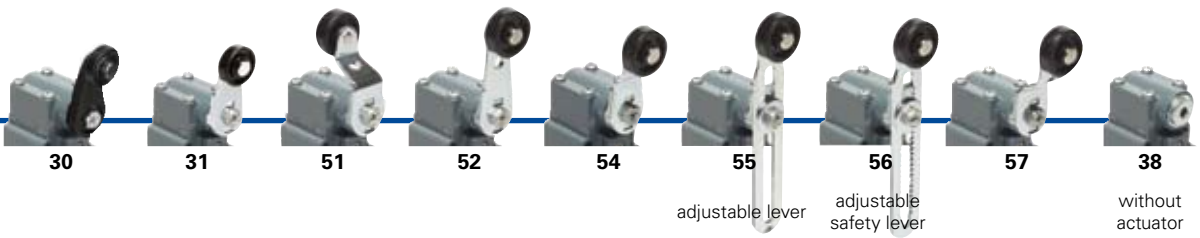

Code structure

Attention! The feasibility of a code number does not mean the effective availability of a product. Please contact our sales office.

article options
FM 502-1W3GM2K50

| Housing | |
|----------------|--|
| FM | metal housing, one conduit entry |
| Contact blocks | |
| 5 | 1NO+1NC, snap action |
| 6 | 1NO+1NC, slow action |
| 7 | 1NO+1NC, slow action overlapped |
| ... | |
| Actuators | |
| 01 | short plunger |
| 02 | roller lever |
| 05 | offset roller lever |
| ... | |
| Suffix | |
| | no suffix (standard) |
| 1 | with stainless steel roller: - Ø 14 mm for actuators A2, 02, A5, 05 - Ø 20 mm for actuators 30, 31, 51, 52, 54, 55, 56, 57 |
| 2 | with Ø 35 mm polymer roller (see special loose actuators on page 2/64) |
| 3 | with Ø 50 mm rubber roller (see special loose actuators on page 2/64) |
| 4 | with Ø 50 mm overhanging rubber roller (see special loose actuators on page 2/64) |

| Preinstalled cable gland or connectors | |
|---|---|
| | no cable gland or connector (standard) |
| K21 | with assembled cable gland suitable for Ø 6 to Ø 12 mm cables range |
| ... | |
| K50 | with 5 poles M12 metal connector |
| ... | |
| For the complete list of all combinations, please contact our technical office. | |
| Threaded conduit entry | |
| | PG 13,5 (standard) |
| M2 | M20x1,5 |
| Contacts type | |
| | silver contacts (standard) |
| G | silver contacts gold plated 1 µm (contact block 2 excluded) |
| Reset hooking | |
| | without reset (standard) |
| W3 | simultaneous reset hooking |



Main data

- Metal housing, one conduit entry
- Protection degree IP67
- 17 contact blocks available
- 43 actuators available
- M12 assembled connector versions
- Silver contacts gold plated versions

Technical data

Housing

Metal housing, coated with baked epoxy powder
 One threaded conduit entry
 Protection degree: IP67 according to EN 60529

General data

Ambient temperature: from -25°C to +80°C
 Version for operation in ambient temperature from -40°C to +80° C on request
 Max actuation frequency: 3600 operations cycles¹/hour
 Mechanical endurance: 20 million operations cycles¹
 Assembling position: any
 Driving torque for installation: see pages 7/1-7/10
 (1) One operation cycle means two movements, one to close and one to open contacts, as foreseen by EN 60947-5-1 standard.

Cross section of the conductors (flexible copper wire)

| | | | |
|--|------|--------------------------|--------------|
| Contact blocks 20, 21, 22, 33, 34: | min. | 1 x 0,34 mm ² | (1 x AWG 22) |
| | max. | 2 x 1,5 mm ² | (2 x AWG 16) |
| Contact blocks 5, 6, 7, 9, 10, 11, 12, 13, 14, 15, 16, 18: | min. | 1 x 0,5 mm ² | (1 x AWG 20) |
| | max. | 2 x 2,5 mm ² | (2 x AWG 14) |
| Contact block 2: | min. | 1 x 0,5 mm ² | (1 x AWG 20) |
| | max. | 2 x 1,5 mm ² | (2 x AWG 16) |

In conformity with standards:

IEC 60947-5-1, EN 60947-5-1, EN 60947-1, EN 50047, IEC 60204-1, EN 60204-1, EN 1088, EN ISO 12100-1, EN ISO 12100-2, IEC 60529, EN 60529, NFC 63-140, VDE 0660-200, VDE 0113.

Approvals:

IEC 60947-5-1, UL 508, GB14048.5-2001.

Markings and quality marks:

Approval IMO: EG609
 Approval UL: E131787
 Approval CCC: 2007010305229998
 Approval ECU: 1010151

In conformity with requirements requested by:

Low Voltage Directive 2006/95/EC, Machinery Directive 2006/42/EC and Electromagnetic Compatibility 2004/108/EC.

Positive contact opening in conformity with standards:

IEC 60947-5-1, EN 60947-5-1, VDE 0660-206.

Installation for safety applications:

Use only switches marked with the symbol ⊕. The safety circuit must always be connected with the **NC contacts** (normally closed contacts: 11-12, 21-22 or 31-32) as stated in the **standard EN 60947-5-1, encl. K, par. 2**. The switch must be actuated with **at least up to the positive opening travel** shown in the travels diagrams on page 7/6. The switch must be actuated **at least with the positive opening force**, shown in brackets, underneath each article, near the value of the min. force.

⚠ If not expressly indicated in this chapter, for the right installation and the correct utilization of all articles see requirements indicated from page 7/1 to page 7/10.

| | Electrical data | Utilization categories |
|----------------------------|---|--|
| without connector | Thermal current (I _{th}): | 10 A |
| | Rated insulation voltage (U _i): | 500 Vac 600 Vdc 400Vac500Vdc(contactblocks2,11,12,20,21,22,33,34) |
| | Rated impulse withstand voltage (U _{imp}): | 6 kV 4 kV (contact blocks 20, 21, 22, 33, 34) |
| | Conditional shot circuit current: Protection against short circuits: Pollution degree: | 1000 A according to EN 60947-5-1 fuse 10 A 500 V type aM 3 |
| with 5 poles M12 connector | Thermal current (I _{th}): | 4 A |
| | Rated insulation voltage (U _i): | 250 Vac 300 Vdc |
| | Protection against short circuits: Pollution degree: | fuse 4 A 500 V type gG 3 |
| | Alternate current: AC15 (50...60 Hz) U _e (V) 250 400 500 I _e (A) 6 4 1 Direct current: DC13 U _e (V) 24 125 250 I _e (A) 6 1,1 0,4 | |
| with 8 poles M12 connector | Thermal current (I _{th}): | 2 A |
| | Rated insulation voltage (U _i): | 30 Vac 36 Vdc |
| | Protection against short circuits: Pollution degree: | fuse 2 A 500 V type gG 3 |
| | Alternate current: AC15 (50...60 Hz) U _e (V) 24 I _e (A) 2 Direct current: DC13 U _e (V) 24 I _e (A) 2 | |



Data type approved by IMQ, CCC and EZU

Rated insulation voltage (Ui): 500 Vac
400 Vac (for contact blocks 2, 11, 12, 20, 21, 22, 33, 34)

Thermal current (Ith): 10 A

Protection against short circuits: fuse 10 A 500 V type aM

Rated impulse withstand voltage (U_{imp}): 6 kV
4 kV (for contact blocks 20, 21, 22, 33, 34)

Protection degree: IP67

MV terminals (screw clamps)

Pollution degree 3

Utilization category: AC15

Operation voltage (Ue): 400 Vac (50 Hz)

Operation current (Ie): 3 A

Forms of the contact element: Za, Zb, Za+Za, Y+Y, X+X, Y+Y+X, Y+Y+Y, Y+X+X

Positive opening of contacts on contact block 5, 6, 7, 9, 11, 13, 14, 16, 18, 20, 21, 22, 33, 34

In conformity with standards: EN 60947-1, EN 60947-5-1+ A1:2009, fundamental requirements of the Low Voltage Directive 2006/95/CE.

Please contact our technical service for the list of approved products.

Data type approved by UL

Utilization categories Q300 (69 VA, 125-250 Vdc)
A600 (720 VA, 120-600 Vac)

Data of the housing type 1, 4X "indoor use only", 12, 13

For all contact blocks except 2 and 3 use 60 or 75 °C copper (Cu) conductor and wire size No. 12-14 AWG. Terminal tightening torque of 7,1 lb in (0,8 Nm).
For contact blocks 2 and 3 use 60 or 75 °C copper (Cu) conductor and wire size No. 14 AWG. Terminal tightening torque of 12 lb in (1,4 Nm).

In conformity with standard: UL 508

Please contact our technical service for the list of approved products.

Adjustable levers

In switches with revolving lever it is possible to adjust the lever with 10° steps for the whole 360° range. The positive movement transmission is always guaranteed thanks to the particular geometrical coupling between the lever and the revolving shaft as prescribed for safety applications by the German standard BG-GS-ET-15.

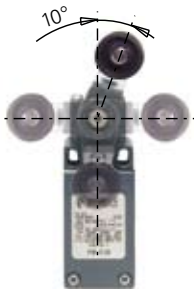

Overturning levers

It's possible to fasten the lever on switches on straight or reverse side, maintaining the positive coupling. In this way it is possible to obtain two different work plans of the lever.



Rotating heads

In all switches, it is possible to rotate the head in 90° steps.



Working operation of contact block 16 with independent contacts

The contact block 16 has two NC contacts, both with positive opening activated independently according to the lever turning direction.

Lever turned to left

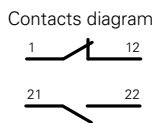

Lever not turned

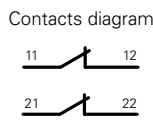

Lever turned to right

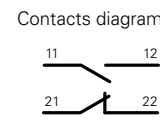

Contacts type:

- R** = snap action
- L** = slow action
- LO** = slow action overlapped
- LS** = slow action shifted
- LV** = slow action shifted and spaced
- LI** = slow action independent
- LA** = slow action closer
- PNP** = electronic PNP

Contact blocks

| | With stainless steel roller on request | With external rubber gasket With stainless steel roller on request | With external rubber gasket Ø 12 mm stainless steel roller |
|-----------------|--|---|---|
| 5 | R FM 501 | R FM 502 | R FM 5A2 |
| 6 | L FM 601 | L FM 602 | L FM 6A2 |
| 7 | LO FM 701 | LO FM 702 | LO FM 7A2 |
| 9 | L FM 901 | L FM 902 | L FM 9A2 |
| 10 | L FM 1001 | L FM 1002 | L FM 10A2 |
| 11 | R FM 1101 | R FM 1102 | R FM 11A2 |
| 12 | R FM 1201 | R FM 1202 | R FM 12A2 |
| 13 | LV FM 1301 | LV FM 1302 | LV FM 13A2 |
| 14 | LS FM 1401 | LS FM 1402 | LS FM 14A2 |
| 15 | LS FM 1501 | LS FM 1502 | LS FM 15A2 |
| 18 | LA FM 1801 | LA FM 1802 | LA FM 18A2 |
| 20 | L FM 2001 | L FM 2002 | L FM 20A2 |
| 21 | L FM 2101 | L FM 2102 | L FM 21A2 |
| 22 | L FM 2201 | L FM 2202 | L FM 22A2 |
| 2 | R FM 201 | R FM 202 | R FM 2A2 |
| E1 | PNP FM E101 | PNP FM E102 | PNP FM E1A2 |
| Max speed | page 7/5 - type 4 | page 7/5 - type 3 | page 7/5 - type 3 |
| Min. force | 8 N (25 N ⊕) | 6 N (25 N ⊕) | 4,3 N (25 N ⊕) |
| Travel diagrams | page 7/6 - group 1 | page 7/6 - group 2 | page 7/6 - group 2 |

| | With stainless steel roller on request | With external rubber gasket With stainless steel roller on request | With external rubber gasket |
|-----------------|--|---|-----------------------------|
| 5 | R FM 505 | R FM 5A5 | R FM 507 |
| 6 | L FM 605 | L FM 6A5 | L FM 607 |
| 7 | LO FM 705 | LO FM 7A5 | LO FM 707 |
| 9 | L FM 905 | L FM 9A5 | L FM 907 |
| 10 | L FM 1005 | L FM 10A5 | L FM 1007 |
| 11 | R FM 1105 | R FM 11A5 | R FM 1107 |
| 12 | R FM 1205 | R FM 12A5 | R FM 1207 |
| 13 | LV FM 1305 | LV FM 13A5 | LV FM 1307 |
| 14 | LS FM 1405 | LS FM 14A5 | LS FM 1407 |
| 15 | LS FM 1505 | LS FM 15A5 | LS FM 1507 |
| 18 | LA FM 1805 | LA FM 18A5 | LA FM 1807 |
| 20 | L FM 2005 | L FM 20A5 | L FM 2007 |
| 21 | L FM 2105 | L FM 21A5 | L FM 2107 |
| 22 | L FM 2205 | L FM 22A5 | L FM 2207 |
| 2 | R FM 205 | R FM 2A5 | R FM 207 |
| E1 | PNP FM E105 | PNP FM E1A5 | PNP FM E107 |
| Max speed | page 7/5 - type 3 | page 7/5 - type 3 | page 7/5 - type 3 |
| Min. force | 6 N (25 N ⊕) | 4,3 N (25 N ⊕) | 4 N (25 N ⊕) |
| Travel diagrams | page 7/6 - group 2 | page 7/6 - group 2 | page 7/6 - group 3 |

Accessories See page 6/1

All measures in the drawings are in mm



Contacts type:

- R** = snap action
- L** = slow action
- LO** = slow action overlapped
- LS** = slow action shifted
- LV** = slow action shifted and spaced
- LI** = slow action independent
- LA** = slow action closer
- E** = electronic PNP

Contact blocks

With external rubber gasket

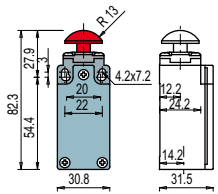
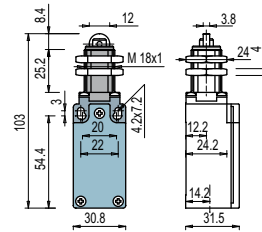
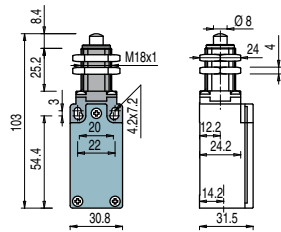
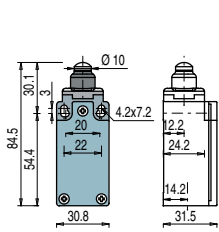

| | | | | | | | | | |
|-----------------|-----------|--------------------|-------------|--------------------|-------------|--------------------|-------------|--------------------|-------------|
| 5 | R | FM 508 | 1NO+1NC | FM 512 | 1NO+1NC | FM 513 | 1NO+1NC | FM 514 | 1NO+1NC |
| 6 | L | FM 608 | 1NO+1NC | FM 612 | 1NO+1NC | FM 613 | 1NO+1NC | FM 614 | 1NO+1NC |
| 7 | LO | FM 708 | 1NO+1NC | FM 712 | 1NO+1NC | FM 713 | 1NO+1NC | FM 714 | 1NO+1NC |
| 9 | L | FM 908 | 2NC | FM 912 | 2NC | FM 913 | 2NC | FM 914 | 2NC |
| 10 | L | FM 1008 | 2NO | FM 1012 | 2NO | FM 1013 | 2NO | FM 1014 | 2NO |
| 11 | R | FM 1108 | 2NC | FM 1112 | 2NC | FM 1113 | 2NC | FM 1114 | 2NC |
| 12 | R | FM 1208 | 2NO | FM 1212 | 2NO | FM 1213 | 2NO | FM 1214 | 2NO |
| 13 | LV | FM 1308 | 2NC | FM 1312 | 2NC | FM 1313 | 2NC | FM 1314 | 2NC |
| 14 | LS | FM 1408 | 2NC | FM 1412 | 2NC | FM 1413 | 2NC | FM 1414 | 2NC |
| 15 | LS | FM 1508 | 2NO | FM 1512 | 2NO | FM 1513 | 2NO | FM 1514 | 2NO |
| 18 | LA | FM 1808 | 1NO+1NC | FM 1812 | 1S+1Ö | FM 1813 | 1S+1Ö | FM 1814 | 1S+1Ö |
| 20 | L | FM 2008 | 1NO+2NC | FM 2012 | 1NO+2NC | FM 2013 | 1NO+2NC | FM 2014 | 1NO+2NC |
| 21 | L | FM 2108 | 3NC | FM 2112 | 3NC | FM 2113 | 3NC | FM 2114 | 3NC |
| 22 | L | FM 2208 | 2NO+1NC | FM 2212 | 2NO+1NC | FM 2213 | 2NO+1NC | FM 2214 | 2NO+1NC |
| 2 | R | FM 208 | 2x(1NO-1NC) | FM 212 | 2x(1NO-1NC) | FM 213 | 2x(1NO-1NC) | FM 214 | 2x(1NO-1NC) |
| E1 | E | FM E108 | 1NO-1NC | FM E112 | 1NO-1NC | FM E113 | 1NO-1NC | FM E114 | 1NO-1NC |
| Max speed | | page 7/5 - type 4 | | page 7/5 - type 4 | | page 7/5 - type 2 | | page 7/5 - type 4 | |
| Min. force | | 8 N (25 N ⊕) | | 8 N (25 N ⊕) | | 8 N (25 N ⊕) | | 8 N (25 N ⊕) | |
| Travel diagrams | | page 7/6 - group 1 | | page 7/6 - group 1 | | page 7/6 - group 1 | | page 7/6 - group 1 | |

Ø 12 mm stainless steel roller

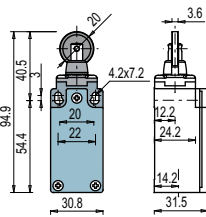
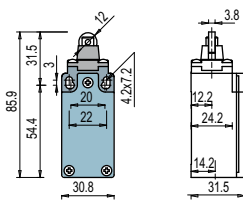

With external rubber gasket

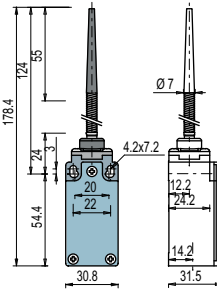

With external rubber gasket

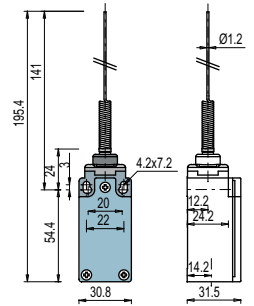

Contact blocks

| | | | | | | | | | |
|-----------------|-----------|--------------------|-------------|--------------------|-------------|--------------------|-------------|--------------------|-------------|
| 5 | R | FM 515 | 1NO+1NC | FM 516 | 1NO+1NC | FM 520 | 1NO+1NC | FM 521 | 1NO+1NC |
| 6 | L | FM 615 | 1NO+1NC | FM 616 | 1NO+1NC | | | | |
| 7 | LO | FM 715 | 1NO+1NC | FM 716 | 1NO+1NC | | | | |
| 9 | L | FM 915 | 2NC | FM 916 | 2NC | | | | |
| 10 | L | FM 1015 | 2NO | FM 1016 | 2NO | FM 1020 | 2NO | FM 1021 | 2NO |
| 11 | R | FM 1115 | 2NC | FM 1116 | 2NC | | | | |
| 12 | R | FM 1215 | 2NO | FM 1216 | 2NO | FM 1220 | 2NO | FM 1221 | 2NO |
| 13 | LV | FM 1315 | 2NC | FM 1316 | 2NC | | | | |
| 14 | LS | FM 1415 | 2NC | FM 1416 | 2NC | | | | |
| 15 | LS | FM 1515 | 2NO | FM 1516 | 2NO | | | | |
| 18 | LA | FM 1815 | 1S+1Ö | FM 1816 | 1S+1Ö | FM 1820 | 1NO+1NC | FM 1821 | 1NO+1NC |
| 20 | L | FM 2015 | 1NO+2NC | FM 2016 | 1NO+2NC | FM 2020 | 1NO+2NC | FM 2021 | 1NO+2NC |
| 21 | L | FM 2115 | 3NC | FM 2116 | 3NC | FM 2120 | 3NC | FM 2121 | 3NC |
| 22 | L | FM 2215 | 2NO+1NC | FM 2216 | 2NO+1NC | FM 2220 | 2NO+1NC | FM 2221 | 2NO+1NC |
| 2 | R | FM 215 | 2x(1NO-1NC) | FM 216 | 2x(1NO-1NC) | FM 220 | 2x(1NO-1NC) | FM 221 | 2x(1NO-1NC) |
| E1 | E | FM E115 | 1NO-1NC | FM E116 | 1NO-1NC | FM E120 | 1NO-1NC | FM E121 | 1NO-1NC |
| Max speed | | page 7/5 - type 2 | | page 7/5 - type 2 | | 1 m/s | | 1 m/s | |
| Min. force | | 8 N (25 N ⊕) | | 8 N (25 N ⊕) | | 0,07 Nm | | 0,07 Nm | |
| Travel diagrams | | page 7/6 - group 1 | | page 7/6 - group 1 | | page 7/6 - group 4 | | page 7/6 - group 4 | |

Items with code on the green background are available in stock

- Contacts type:
- R** = snap action
 - L** = slow action
 - LO** = slow action overlapped
 - LS** = slow action shifted
 - LV** = slow action shifted and spaced
 - LI** = slow action independent
 - LA** = slow action closer
 - E1** = electronic PNP

Contact blocks

| | With external rubber gasket | With Ø 20 mm stainless steel roller on request | Other rollers available. See page 2/64 | 3x3 mm square rod |
|-----------------|-----------------------------|--|--|--------------------|
| 5 R | FM 525 | FM 530 | FM 531 | FM 533 |
| 6 L | | FM 630 | FM 631 | FM 633 |
| 7 LO | | FM 730 | FM 731 | FM 733 |
| 9 L | | FM 930 | FM 931 | FM 933 |
| 10 L | FM 1025 | FM 1030 | FM 1031 | FM 1033 |
| 11 R | | FM 1130 | FM 1131 | FM 1133 |
| 12 R | FM 1225 | FM 1230 | FM 1231 | FM 1233 |
| 13 LV | | FM 1330 | FM 1331 | FM 1333 |
| 14 LS | | FM 1430 | FM 1431 | FM 1433 |
| 15 LS | | FM 1530 | FM 1531 | FM 1533 |
| 16 LI | | FM 1630 | FM 1631 | FM 1633 |
| 18 LA | FM 1825 | FM 1830 | FM 1831 | FM 1833 |
| 20 L | FM 2025 | FM 2030 | FM 2031 | FM 2033 |
| 21 L | FM 2125 | FM 2130 | FM 2131 | FM 2133 |
| 22 L | FM 2225 | FM 2230 | FM 2231 | FM 2233 |
| 2 R | FM 225 | FM 230 | FM 231 | FM 233 |
| E1 E1 | FM E125 | FM E130 | FM E131 | FM E133 |
| Max speed | 1 m/s | page 7/5 - type 1 | page 7/5 - type 1 | 1,5 m/s |
| Min. force | 0,12 Nm | 0,06 Nm (0,25 Nm ⊕) | 0,06 Nm (0,25 Nm ⊕) | 0,06 Nm |
| Travel diagrams | page 7/6 - group 4 | page 7/6 - group 5 | page 7/6 - group 5 | page 7/6 - group 5 |

| | Ø 3 mm stainless steel round rod | Other rollers available. See page 2/64 | Other rollers available. See page 2/64 |
|-----------------|----------------------------------|--|--|
| 5 R | FM 534 | FM 551 | FM 552 |
| 6 L | FM 634 | FM 651 | FM 652 |
| 7 LO | FM 734 | FM 751 | FM 752 |
| 9 L | FM 934 | FM 951 | FM 952 |
| 10 L | FM 1034 | FM 1051 | FM 1052 |
| 11 R | FM 1134 | FM 1151 | FM 1152 |
| 12 R | FM 1234 | FM 1251 | FM 1252 |
| 13 LV | FM 1334 | FM 1351 | FM 1352 |
| 14 LS | FM 1434 | FM 1451 | FM 1452 |
| 15 LS | FM 1534 | FM 1551 | FM 1552 |
| 16 LI | FM 1634 | FM 1651 | FM 1652 |
| 18 LA | FM 1834 | FM 1851 | FM 1852 |
| 20 L | FM 2034 | FM 2051 | FM 2052 |
| 21 L | FM 2134 | FM 2151 | FM 2152 |
| 22 L | FM 2234 | FM 2251 | FM 2252 |
| 2 R | FM 234 | FM 251 | FM 252 |
| E1 E1 | FM E134 | FM E151 | FM E152 |
| Max speed | 1,5 m/s | page 7/5 - type 1 | page 7/5 - type 1 |
| Min. force | 0,06 Nm | 0,06 Nm (0,25 Nm ⊕) | 0,06 Nm (0,25 Nm ⊕) |
| Travel diagrams | page 7/6 - group 5 | page 7/6 - group 5 | page 7/6 - group 5 |

Accessories See page 6/1



Contacts type:

- R** = snap action
- L** = slow action
- LO** = slow action overlapped
- LS** = slow action shifted
- LV** = slow action shifted and spaced
- LI** = slow action independent
- LA** = slow action closer
- A** = electronic PNP

Contact blocks

| | Porcelain roller | Other rollers available. See page 2/64 | Other rollers available. See page 2/64 | Other rollers available. See page 2/64 |
|-----------------|-----------------------------|--|--|--|
| | | | | |
| 5 | R FM 553-E0V9 | R FM 554 | R FM 555 | R FM 556 |
| 6 | L FM 653-E0V9 | L FM 654 | L FM 655 | L FM 656 |
| 7 | LO FM 753-E0V9 | LO FM 754 | LO FM 755 | LO FM 756 |
| 9 | L FM 953-E0V9 | L FM 954 | L FM 955 | L FM 956 |
| 10 | L FM 1053-E0V9 | L FM 1054 | L FM 1055 | L FM 1056 |
| 11 | R FM 1153-E0V9 | R FM 1154 | R FM 1155 | R FM 1156 |
| 12 | R FM 1253-E0V9 | R FM 1254 | R FM 1255 | R FM 1256 |
| 13 | LV FM 1353-E0V9 | LV FM 1354 | LV FM 1355 | LV FM 1356 |
| 14 | LS FM 1453-E0V9 | LS FM 1454 | LS FM 1455 | LS FM 1456 |
| 15 | LS FM 1553-E0V9 | LS FM 1554 | LS FM 1555 | LS FM 1556 |
| 16 | LI FM 1653-E0V9 | LI FM 1654 | LI FM 1655 | LI FM 1656 |
| 18 | LA FM 1853-E0V9 | LA FM 1854 | LA FM 1855 | LA FM 1856 |
| 20 | L FM 2053-E0V9 | L FM 2054 | L FM 2055 | L FM 2056 |
| 21 | L FM 2153-E0V9 | L FM 2154 | L FM 2155 | L FM 2156 |
| 22 | L FM 2253-E0V9 | L FM 2254 | L FM 2255 | L FM 2256 |
| 2 | R FM 253-E0 | R FM 254 | R FM 255 | R FM 256 |
| E1 | A FM E153-E0V9 | A FM E154 | A FM E155 | A FM E156 |
| Max speed | 0,5 m/s | page 7/5 - type 1 | page 7/5 - type 1 | page 7/5 - type 1 |
| Min. force | 0,03 Nm (0,25 Nm \oplus) | 0,06 Nm (0,25 Nm \oplus) | 0,06 Nm (0,25 Nm \oplus) | 0,06 Nm (0,25 Nm \oplus) |
| Travel diagrams | page 7/6 - group 6 | page 7/6 - group 5 | page 7/6 - group 5 | page 7/6 - group 5 |

Contact blocks

| | Other rollers available. See page 2/64 | Fiber glass rod | Rope switches for signalling | |
|-----------------|--|--------------------|------------------------------|--|
| | | | | |
| 5 | R FM 557 | R FM 569 | R FM 576 | |
| 6 | L FM 657 | L FM 669 | L FM 676 | |
| 7 | LO FM 757 | LO FM 769 | LO FM 776 | |
| 9 | L FM 957 | L FM 969 | L FM 976 | |
| 10 | L FM 1057 | L FM 1069 | L FM 1076 | |
| 11 | R FM 1157 | R FM 1169 | R FM 1176 | |
| 12 | R FM 1257 | R FM 1269 | R FM 1276 | |
| 13 | LV FM 1357 | LV FM 1369 | LV FM 1376 | |
| 14 | LS FM 1457 | LS FM 1469 | LS FM 1476 | |
| 15 | LS FM 1557 | LS FM 1569 | LS FM 1576 | |
| 16 | LI FM 1657 | LI FM 1669 | | |
| 18 | LA FM 1857 | LA FM 1869 | LA FM 1876 | |
| 20 | L FM 2057 | L FM 2069 | L FM 2076 | |
| 21 | L FM 2157 | L FM 2169 | L FM 2176 | |
| 22 | L FM 2257 | L FM 2269 | L FM 2276 | |
| 2 | R FM 257 | R FM 269 | R FM 276 | |
| E1 | A FM E157 | A FM E169 | | |
| Max speed | page 7/5 - type 1 | 1,5 m/s | 0,5 m/s | |
| Min. force | 0,06 Nm (0,25 Nm \oplus) | 0,06 Nm | initial 20 N - final 40 N | |
| Travel diagrams | page 7/6 - group 5 | page 7/6 - group 5 | page 7/6 - group 7 | |

Items with code on the green background are available in stock

(1) Positive opening only with lever adjusted on the max. See page 2/63.
General Catalog 2011-2012



Position switches FM series with reset



Pizzato Elettrica has developed a reset device code W3 to make perfectly simultaneous the actuator and the contact block tripping. The new device is a block inserted between the switch body and the head, and could be rotated independently from this last one. This new device has following advantages:

- * The reset device integrate in any standard actuation head
- * Contact blocks with snap action are no more necessary because the tripping movement is made by the reset device itself
- * The reset device can be rotated independently from the head for the maximum flexibility during the assembling.

Contacts type:

- R** = snap action
- L** = slow action

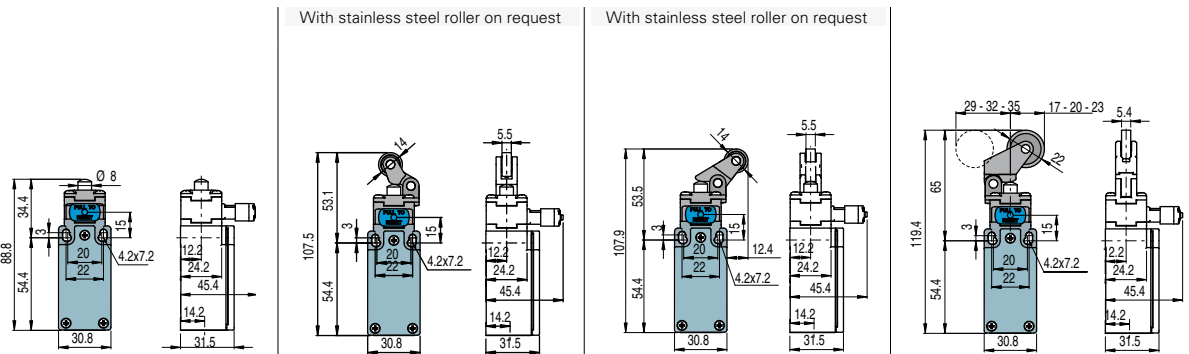

Contact blocks

| | | | | | | | | | |
|-----------------|----------|--------------------|-----------|--------------------|-----------|--------------------|-----------|--------------------|-----------|
| 6 | L | FM 601-W3 | ⊕ 1NO+1NC | FM 602-W3 | ⊕ 1NO+1NC | FM 605-W3 | ⊕ 1NO+1NC | FM 607-W3 | ⊕ 1NO+1NC |
| 9 | L | FM 901-W3 | ⊕ 2NC | FM 902-W3 | ⊕ 2NC | FM 905-W3 | ⊕ 2NC | FM 907-W3 | ⊕ 2NC |
| 10 | L | FM 1001-W3 | 2NO | FM 1002-W3 | 2NO | FM 1005-W3 | 2NO | FM 1007-W3 | 2NO |
| 20 | L | FM 2001-W3 | ⊕ 1NO+2NC | FM 2002-W3 | ⊕ 1NO+2NC | FM 2005-W3 | ⊕ 1NO+2NC | FM 2007-W3 | ⊕ 1NO+2NC |
| 21 | L | FM 2101-W3 | ⊕ 3NC | FM 2102-W3 | ⊕ 3NC | FM 2105-W3 | ⊕ 3NC | FM 2107-W3 | ⊕ 3NC |
| 22 | L | FM 2201-W3 | ⊕ 2NO+1NC | FM 2202-W3 | ⊕ 2NO+1NC | FM 2205-W3 | ⊕ 2NO+1NC | FM 2207-W3 | ⊕ 2NO+1NC |
| 2 | R | FM 201-W3 | 2NO+2NC | FM 202-W3 | 2NO+2NC | FM 205-W3 | 2NO+2NC | FM 207-W3 | 2NO+2NC |
| Max speed | | page 7/5 - type 4 | | page 7/5 - type 3 | | page 7/5 - type 3 | | page 7/5 - type 3 | |
| Min. force | | 8 N (25 N ⊕) | | 6 N (25 N ⊕) | | 6 N (25 N ⊕) | | 4 N (25 N ⊕) | |
| Travel diagrams | | page 7/7 - group 1 | | page 7/7 - group 2 | | page 7/7 - group 2 | | page 7/7 - group 3 | |

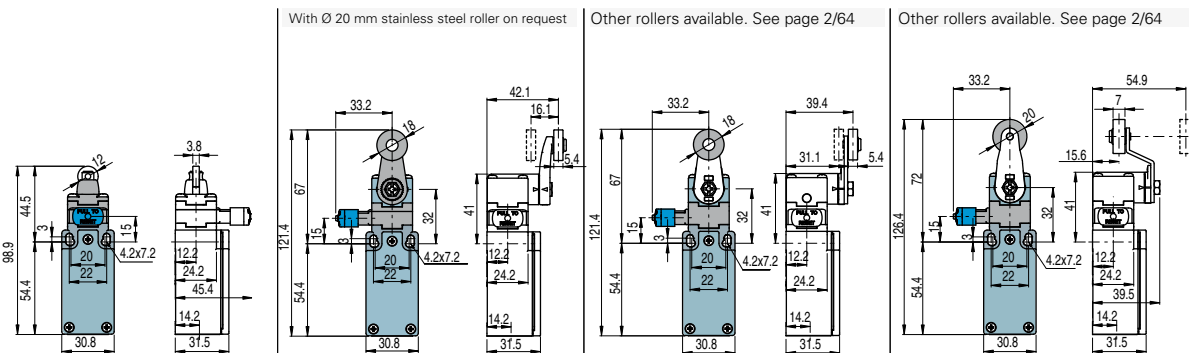

Contact blocks

| | | | | | | | | | |
|-----------------|----------|--------------------|-----------|---------------------|-----------|---------------------|-----------|---------------------|-----------|
| 6 | L | FM 615-W3 | ⊕ 1NO+1NC | FM 630-W3 | ⊕ 1NO+1NC | FM 631-W3 | ⊕ 1NO+1NC | FM 651-W3 | ⊕ 1NO+1NC |
| 9 | L | FM 915-W3 | ⊕ 2NC | FM 930-W3 | ⊕ 2NC | FM 931-W3 | ⊕ 2NC | FM 951-W3 | ⊕ 2NC |
| 10 | L | FM 1015-W3 | 2NO | FM 1030-W3 | 2NO | FM 1031-W3 | 2NO | FM 1051-W3 | 2NO |
| 20 | L | FM 2015-W3 | ⊕ 1NO+2NC | FM 2030-W3 | ⊕ 1NO+2NC | FM 2031-W3 | ⊕ 1NO+2NC | FM 2051-W3 | ⊕ 1NO+2NC |
| 21 | L | FM 2115-W3 | ⊕ 3NC | FM 2130-W3 | ⊕ 3NC | FM 2131-W3 | ⊕ 3NC | FM 2151-W3 | ⊕ 3NC |
| 22 | L | FM 2215-W3 | ⊕ 2NO+1NC | FM 2230-W3 | ⊕ 2NO+1NC | FM 2231-W3 | ⊕ 2NO+1NC | FM 2251-W3 | ⊕ 2NO+1NC |
| 2 | R | FM 215-W3 | 2NO+2NC | FM 230-W3 | 2NO+2NC | FM 231-W3 | 2NO+2NC | FM 251-W3 | 2NO+2NC |
| Max speed | | page 7/5 - type 2 | | page 7/5 - type 1 | | page 7/5 - type 1 | | page 7/5 - type 1 | |
| Min. force | | 8 N (25 N ⊕) | | 0,06 Nm (0,25 Nm ⊕) | | 0,06 Nm (0,25 Nm ⊕) | | 0,06 Nm (0,25 Nm ⊕) | |
| Travel diagrams | | page 7/7 - group 1 | | page 7/7 - group 4 | | page 7/7 - group 4 | | page 7/7 - group 4 | |

Contacts type:

R = snap action
L = slow action

Other rollers available. See page 2/64

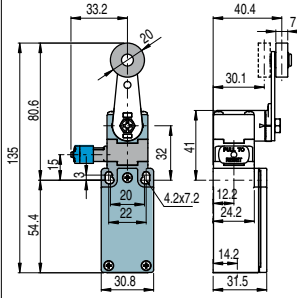

Other rollers available. See page 2/64

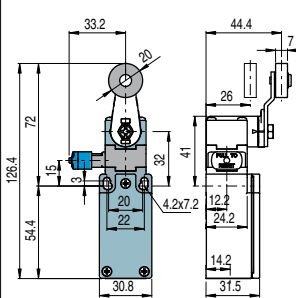

Other rollers available. See page 2/64

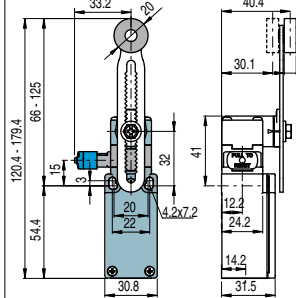

Other rollers available. See page 2/64

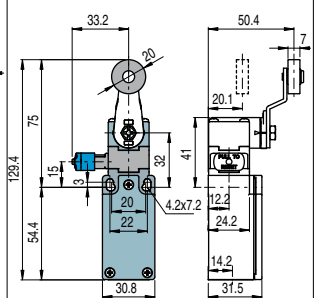

Contact blocks

| | | | | | | | | | |
|-----------------|----------|--------------------|---------|--------------------|---------|--------------------|---------|--------------------|---------|
| 6 | L | FM 652-W3 | 1NO+1NC | FM 654-W3 | 1NO+1NC | FM 656-W3 | 1NO+1NC | FM 657-W3 | 1NO+1NC |
| 9 | L | FM 952-W3 | 2NC | FM 954-W3 | 2NC | FM 956-W3 | 2NC | FM 957-W3 | 2NC |
| 10 | L | FM 1052-W3 | 2NO | FM 1054-W3 | 2NO | FM 1056-W3 | 2NO | FM 1057-W3 | 2NO |
| 20 | L | FM 2052-W3 | 1NO+2NC | FM 2054-W3 | 1NO+2NC | FM 2056-W3 | 1NO+2NC | FM 2057-W3 | 1NO+2NC |
| 21 | L | FM 2152-W3 | 3NC | FM 2154-W3 | 3NC | FM 2156-W3 | 3NC | FM 2157-W3 | 3NC |
| 22 | L | FM 2252-W3 | 2NO+1NC | FM 2254-W3 | 2NO+1NC | FM 2256-W3 | 2NO+1NC | FM 2257-W3 | 2NO+1NC |
| 2 | R | FM 252-W3 | 2NO+2NC | FM 254-W3 | 2NO+2NC | FM 256-W3 | 2NO+2NC | FM 257-W3 | 2NO+2NC |
| Max speed | | page 7/5 - type 1 | | page 7/5 - type 1 | | page 7/5 - type 1 | | page 7/5 - type 1 | |
| Min. force | | 0,06 Nm (0,25 Nm | | 0,06 Nm (0,25 Nm | | 0,06 Nm (0,25 Nm | | 0,06 Nm (0,25 Nm | |
| Travel diagrams | | page 7/7 - group 4 | | page 7/7 - group 4 | | page 7/7 - group 4 | | page 7/7 - group 4 | |

 Items with code on the **green** background are available in stock

Position switches with revolving lever without actuator

Contacts type:

- R** = snap action
- L** = slow action
- LO** = slow action overlapped
- LS** = slow action shifted
- LV** = slow action shifted and spaced
- LI** = slow action independent
- LA** = slow action closer
- = electronic PNP

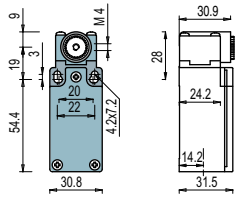

With manual reset knob

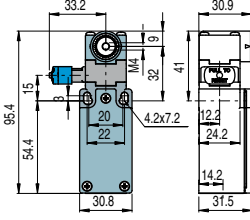

IMPORTANT

For safety applications: join only switches and actuators marked with symbol ⊕.
For more information about safety applications see page 7/1.

Contact blocks

| | | | | |
|-----------------|-----------|---------------------|-------------|-----------------------------|
| 5 | R | FM 538 ⊕ | 1NO+1NC | |
| 6 | L | FM 638 ⊕ | 1NO+1NC | FM 638-W3 ⊕ 1NO+1NC |
| 7 | LO | FM 738 ⊕ | 1NO+1NC | |
| 9 | L | FM 938 ⊕ | 2NC | FM 938-W3 ⊕ 2NC |
| 10 | L | FM 1038 | 2NO | FM 1038-W3 2NO |
| 11 | R | FM 1138 ⊕ | 2NC | |
| 12 | R | FM 1238 | 2NO | |
| 13 | LV | FM 1338 ⊕ | 2NC | |
| 14 | LS | FM 1438 ⊕ | 2NC | |
| 15 | LS | FM 1538 | 2NO | |
| 16 | LI | FM 1638 ⊕ | 2NC | |
| 18 | LA | FM 1838 ⊕ | 1NO+1NC | |
| 20 | L | FM 2038 ⊕ | 1NO+2NC | FM 2038-W3 ⊕ 1NO+2NC |
| 21 | L | FM 2138 ⊕ | 3NC | FM 2138-W3 ⊕ 3NC |
| 22 | L | FM 2238 ⊕ | 2NO+1NC | FM 2238-W3 ⊕ 2NO+1NC |
| 2 | R | FM 238 | 2x(1NO-1NC) | FM 238-W3 2NO+2NC |
| E1 | | FM E138 | 1NO-1NC | |
| Min. force | | 0,06 Nm (0,25 Nm) ⊕ | | 0,06 Nm (0,25 Nm) ⊕ |
| Travel diagrams | | page 7/6 - group 5 | | page 7/7 - group 4 |

Loose actuators

IMPORTANT: These loose actuators can be used with items of series FR, FM, FX, FZ, FK only.

| Polymer roller Ø 18 mm | Polymer roller Ø 18 mm | Adjustable square rod 3x3x125 mm | Flexible rod actuator | Adjustable round rod Ø 3x125 mm | Polymer roller Ø 20 mm | |
|---------------------------|---------------------------------|-------------------------------------|--|---|---------------------------|----------------------------|
| | | | | | | |
| VF LE30 ⊕ | VF LE31 ⊕ | VF LE33 | VF LE34 | VF LE50 | VF LE51 ⊕ | |
| Polymer roller Ø 20 mm | Porcelain roller | Polymer roller Ø 20 mm | Adjustable actuator with polymer roller | Adjustable safety actuator with polymer roller | Polymer roller Ø 20 mm | Adjustable fiber glass rod |
| | | | | | | |
| VF LE52 ⊕ | VF LE53 ⊕ ⁽²⁾ | VF LE54 ⊕ | VF LE55 ⊕ ⁽¹⁾ | VF LE56 ⊕ | VF LE57 ⊕ | VF LE69 |

- Only orders for multiple quantities of the packs are accepted.

⁽¹⁾ Actuator VF LE55 suits to safety applications only if adjusted to its max length, as you can see in figure beside. If you need an adjustable lever for safety applications, use the adjustable safety lever VF LE56.

⁽²⁾ The position switch obtained by assembling the switch FM •38 (e.g. FM 538, FM 638) with the actuator VF LE53 will not present the same travel diagrams and actuating forces as the position switch FM •53-E0V9 (e.g. FM 553-E0V9, FM 653-E0V9...).

⁽⁴⁾ The actuator cannot be oriented to inside direction because it will mechanically interfere with the switch head.

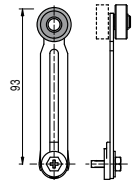

Accessories See page 6/1



Special loose actuators

IMPORTANT: These loose actuators can be used with items of series FR, FM, FX, FZ, FK only.

Ø 20 mm stainless steel rollers

| | | | | | | |
|---------------|---------------|---------------|---------------|---------------|---------------|---------------|
| | | | | | | |
| VF LE31-1 (4) | VF LE51-1 (4) | VF LE52-1 (4) | VF LE54-1 (4) | VF LE55-1 (1) | VF LE56-1 (4) | VF LE57-1 (4) |

Ø 35 mm polymer rollers

| | | | | | | |
|---------------|---------------|---------------|---------------|---------------|---------------|---------------|
| | | | | | | |
| VF LE31-2 (4) | VF LE51-2 (4) | VF LE52-2 (4) | VF LE54-2 (4) | VF LE55-2 (1) | VF LE56-2 (4) | VF LE57-2 (4) |

Ø 40 mm rubber rollers

| | | | | | | |
|----------------|----------------|----------------|----------------|----------------|----------------|----------------|
| | | | | | | |
| VF LE31-R5 (4) | VF LE51-R5 (4) | VF LE52-R5 (4) | VF LE54-R5 (4) | VF LE55-R5 (1) | VF LE56-R5 (4) | VF LE57-R5 (4) |

Ø 50 mm rubber rollers

| | | | | | |
|---------------|---------------|---------------|---------------|---------------|---------------|
| | | | | | |
| VF LE51-3 (4) | VF LE52-3 (4) | VF LE54-3 (4) | VF LE55-3 (1) | VF LE56-3 (4) | VF LE57-3 (4) |

Ø 50 mm overhanging rubber rollers

| | |
|---------------|---------------|
| | |
| VF LE55-4 (1) | VF LE56-4 (4) |

Items with code on the green background are available in stock

X-ON Electronics

Largest Supplier of Electrical and Electronic Components

Click to view similar products for [Limit Switches](#) category:

Click to view products by [Pizzato](#) manufacturer:

Other Similar products are found below :

[5ML1-E1](#) [5ML31](#) [LZG1](#) [LZL1-6C](#) [622EN114-R](#) [622EN18-6](#) [622EN224-6B](#) [622EN230](#) [622EN237-R](#) [622EN69-3](#) [622EN85-RB](#) [MA-10019](#)
[6PA109](#) [7LS51](#) [83547001](#) [83725002](#) [83830001](#) [83840701](#) [83841001](#) [83881140](#) [8AS42](#) [8LS10](#) [8LS125-4PG](#) [8LS152-4PGN20](#) [914CE16-](#)
[3A](#) [914CE3-3L1](#) [915PA10](#) [91MCE16-P2O](#) [924CE16-Y3](#) [924CE1-S6](#) [924CE1-T25A](#) [924CE1-T3](#) [924CE1-T9A](#) [924CE2-T9](#) [924CE31-Y20-](#)
[X5](#) [924CE31-Y3L1](#) [GL-10054](#) [GLDB03C-6](#) [GLZ324](#) [H3141CAKAA](#) [RDI-G-L5B](#) [DD-10000](#) [DT-2R3-A7](#) [14CE16-3N28](#) [14CE18-N15](#)
[151ML3-E1](#) [E3102BAAAA](#) [BFL1-AW1-S](#) [1EN329-R](#) [1LS1-4PGN159](#)