

## Selection diagram

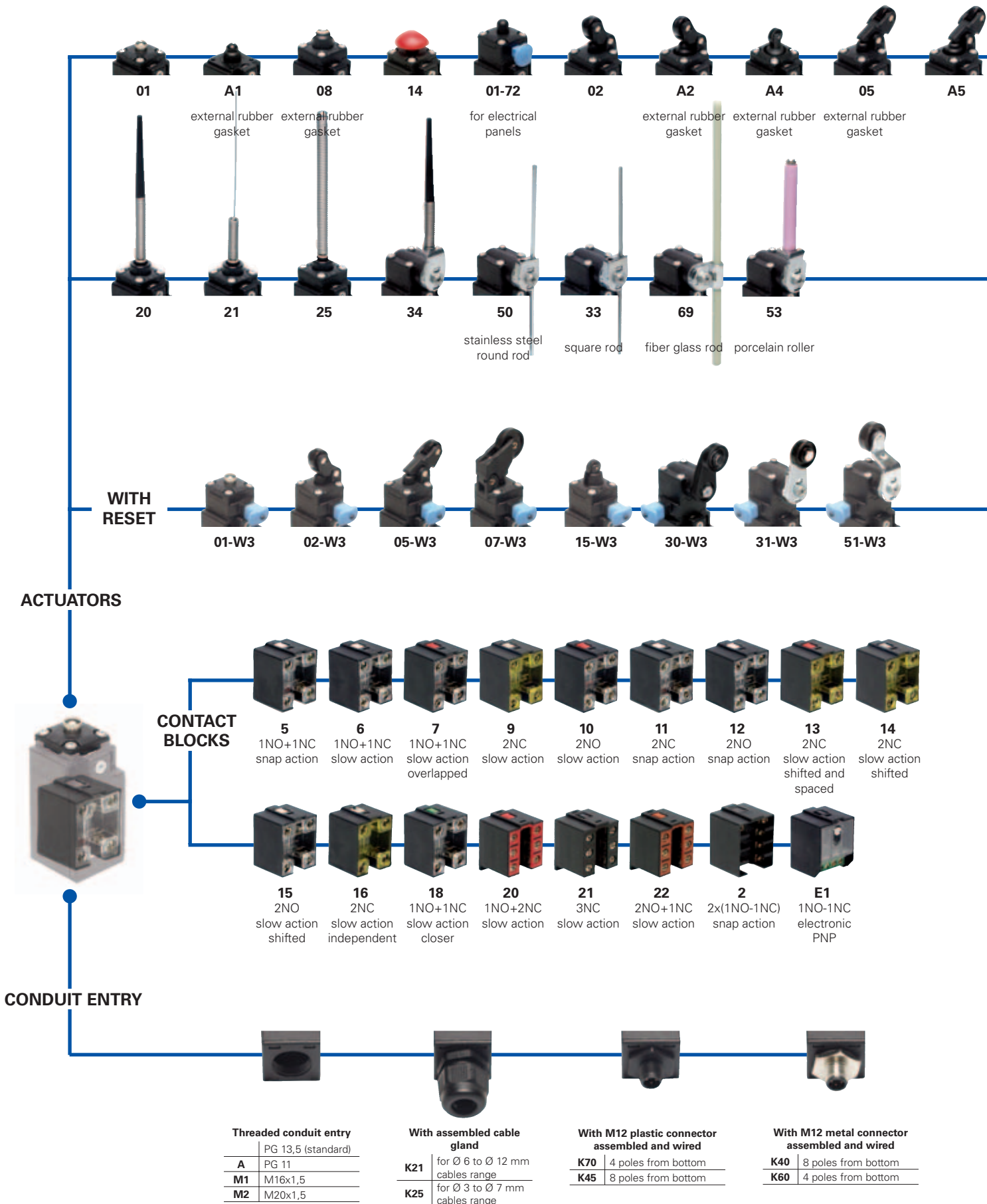

● product option  
 → accessory sold separately

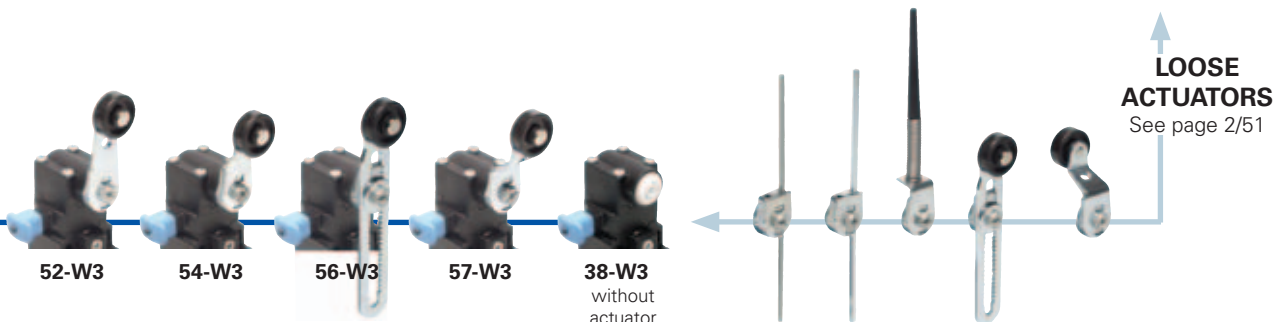
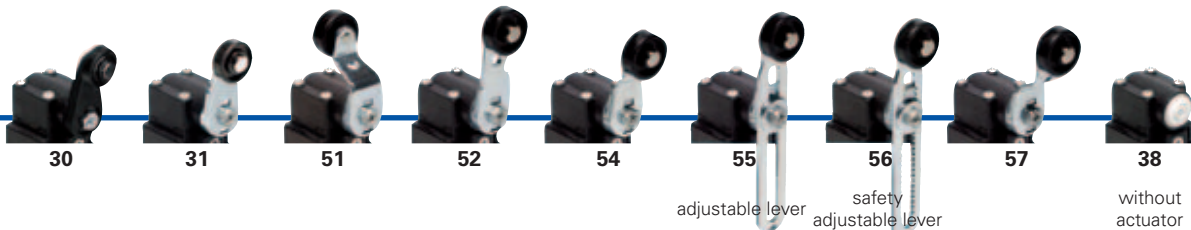
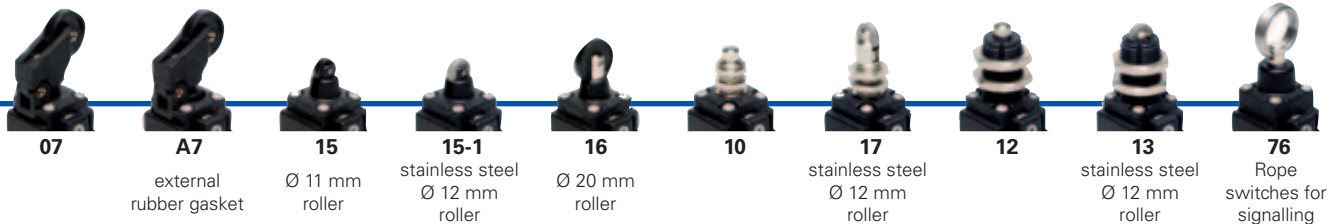

### Code structure

**Attention!** The feasibility of a code number does not mean the effective availability of a product. Please contact our sales office.

article options  
**FR 502-1W3XGM2K70**

#### Housing

**FR** polymer housing, one conduit entry

#### Contact blocks

<b>5</b>	1NO+1NC, snap action
<b>6</b>	1NO+1NC, slow action
<b>7</b>	1NO+1NC, slow action overlapped
...	.....

#### Actuators

<b>01</b>	short plunger
<b>02</b>	roller lever
<b>05</b>	offset roller lever
...	.....

#### Suffix

	no suffix (standard)
<b>1</b>	with stainless steel roller: - Ø 12 mm for actuators A2, 02, A5, 05 - Ø 14 mm for actuators 30, 31, 51, 52, 54, 55, 56, 57
<b>2</b>	with Ø 35 mm polymer roller (see special loose actuators on page 2/52)
<b>3</b>	with Ø 50 mm rubber roller (see special loose actuators on page 2/52)
<b>4</b>	with Ø 50 mm overhanging rubber roller (see special loose actuators on page 2/52)

#### Preinstalled cable gland or connectors

	no cable gland or connector (standard)
<b>K21</b>	with assembled cable gland suitable for Ø 6 to Ø 12 mm cables range
...	.....
<b>K70</b>	with 4 poles M12 plastic connector
...	.....

For the complete list of all combinations, please contact our technical office.

#### Threaded conduit entry

	PG 13,5 (standard)
<b>A</b>	PG 11
<b>M1</b>	M16x1,5
<b>M2</b>	M20x1,5

#### Contacts type

	silver contacts (standard)
<b>G</b>	silver contacts gold plated 1 µm (contact block 2 excluded)

#### External metallic parts

	zinc plated steel (standard)
<b>X</b>	stainless steel

#### Reset hooking

	without reset (standard)
<b>W3</b>	normal reset hooking

1  
 1A  
 1B  
 2  
 2A  
 2B  
 2C  
 2D  
 2E  
 3  
 3A  
 3B  
 3C  
 4  
 4A  
 4B  
 4C  
 4D  
 4E  
 4F  
 4G  
 4H  
 5  
 6



### Main data

- Polymer housing, one conduit entry
- Protection degree IP67
- 17 contact blocks available
- 48 actuators available
- External stainless steel parts versions
- M12 assembled connector versions
- Silver contacts gold plated versions

### Markings and quality marks:



Approval IMQ: EG610  
 Approval UL: E131787  
 Approval CCC: 2007010305230013  
 Approval EZU: 1010151

### Technical data

#### Housing

Made of glass-reinforced polymer, self-extinguishing, shock-proof thermoplastic resin and with double insulation  $\square$   
 One threaded conduit entry  
 Protection degree: IP67 according to EN 60529

#### General data

Ambient temperature: from -25°C to +80°C  
 Version for operation in ambient temperature from -40°C to +80°C on request  
 Max operating frequency: 3600 operations cycles<sup>1</sup>/hour  
 Mechanical endurance: 20 million operations cycles<sup>1</sup>  
 Assembling position: any  
 Driving torque for installation: see pages 6/1-6/10  
 (1) One operation cycle means two movements, one to close and one to open contacts, as foreseen by EN 60947-5-1 standard.

#### Cross section of the conductors (flexible copper wire)

Contact blocks 20, 21, 22, 33, 34:	min.	1 x 0,34 mm <sup>2</sup>	(1 x AWG 22)
	max.	2 x 1,5 mm <sup>2</sup>	(2 x AWG 16)
Contact blocks 5, 6, 7, 9, 10, 11, 12, 13, 14, 15, 16, 18:	min.	1 x 0,5 mm <sup>2</sup>	(1 x AWG 20)
	max.	2 x 2,5 mm <sup>2</sup>	(2 x AWG 14)
Contact block 2:	min.	1 x 0,5 mm <sup>2</sup>	(1 x AWG 20)
	max.	2 x 1,5 mm <sup>2</sup>	(2 x AWG 16)

#### In conformity with standards:

IEC 60947-5-1, EN 60947-5-1, EN 50047, IEC 60204-1, EN 60204-1, EN 1088, EN ISO 12100-1, EN ISO 12100-2, IEC 60529, EN 60529, NFC 63-140, VDE 0660-200, VDE 0113, CENELEC EN 50013.

#### Approvals:

IEC 60947-5-1, UL 508, GB14048.5-2001

#### In conformity with requirements requested by:

Low Voltage Directive 2006/95/EC, Machinery Directive 2006/42/EC and Electromagnetic Compatibility 2004/108/EC.

#### Positive contact opening in conformity with standards:

IEC 60947-5-1, EN 60947-5-1, VDE 0660-206.

### Installation for safety applications:

Use only switches marked with the symbol  $\ominus$ . The safety circuit must always be connected with the **NC contacts** (normally closed contacts: 11-12, 21-22 or 31-32) as stated in the **standard EN 60947-5-1, encl. K, par. 2**. The switch must be actuated with **at least up to the positive opening travel** shown in the travels diagrams on page 6/6. The switch must be actuated **at least with the positive opening force**, shown in brackets, underneath each article, near the value of the min. force.

**⚠ If not expressly indicated in this chapter, for the right installation and the correct utilization of all articles see requirements indicated from page 6/1 to page 6/10.**

Electrical data		Utilization categories	
without connector	Thermal current (I <sub>th</sub> ):	10 A	
	Rated insulation voltage (U <sub>i</sub> ):	500 Vac 600 Vdc	Alternate current: AC15 (50...60 Hz)
		400 Vac 500 Vdc	
		for contact blocks 20, 21, 22, 33, 34	I <sub>e</sub> (A) 6 4 1
	Conditional short circuit current:	1000 A according to EN 60947-5-1	Direct current: DC13
Protection against short circuits:	fuse 10 A 500 V type aM	U <sub>e</sub> (V) 24 125 250	
Pollution degree:	3	I <sub>e</sub> (A) 6 1,1 0,4	
with 4 poles M12 connector	Thermal current (I <sub>th</sub> ):	4 A	
	Rated insulation voltage (U <sub>i</sub> ):	250 Vac 300 Vdc	Alternate current: AC15 (50...60 Hz)
		Protection against short circuits:	
			I <sub>e</sub> (A) 4 4 4
	Pollution degree:	3	Direct current: DC13
		U <sub>e</sub> (V) 24 125 250	
		I <sub>e</sub> (A) 4 1,1 0,4	
with 8 poles M12 connector	Thermal current (I <sub>th</sub> ):	2 A	
	Rated insulation voltage (U <sub>i</sub> ):	30 Vac 36 Vdc	Alternate current: AC15 (50...60 Hz)
		Protection against short circuits:	
			I <sub>e</sub> (A) 2
	Pollution degree:	3	Direct current: DC13
		U <sub>e</sub> (V) 24	
		I <sub>e</sub> (A) 2	



### Data type approved by IMQ, CCC and EZU

Rated insulation voltage (Ui): 500 Vac  
400 Vac for contact blocks 20, 21, 22, 33, 34

Thermal current (Ith): 10 A

Protection against short circuits: fuse 10 A 500 V type aM

Protection degree: IP67

MV terminals (screw clamps)

Pollution degree 3

Utilization category: AC15

Operation voltage (Ue): 400 Vac (50 Hz)

Operation current (Ie): 3 A

Forms of the contact element: Za, Zb, Za+Za, Y+Y, X+X, Y+Y+X, Y+Y+Y, Y+X+X

Positive opening of contacts on contact block 5, 6, 7, 9, 11, 13, 14, 16, 18, 20, 21, 22, 33, 34

In conformity with standards: EN 60947-1, EN 60947-5-1 and subsequent modifications and completions, fundamental requirements of the Low Voltage Directive 2006/95/CE and subsequent modifications and completions.

Please contact our technical service for the list of approved products.

### Data type approved by UL

Utilization categories Q300 (69 VA, 125-250 Vdc)  
A600 (720 VA, 120-600 Vac)

Data of the housing type 1, 4X "indoor use only"; 12, 13

For all contact blocks except 2 and 3 use 60 or 75 °C copper (Cu) conductor and wire size No. 12-14 AWG. Terminal tightening torque of 7,1 lb in (0,8 Nm).  
For contact blocks 2 and 3 use 60 or 75 °C copper (Cu) conductor and wire size No. 14 AWG. Terminal tightening torque of 12 lb in (1,4 Nm).

In conformity with standard: UL 508

Please contact our technical service for the list of approved products.

### Adjustable levers

In switches with revolving lever it is possible to adjust the lever with 10° steps for the whole 360° range. The positive movement



transmission is always guaranteed thanks to the particular geometrical coupling between the lever and the revolving shaft as prescribed for safety applications by the German standard BG-GS-ET-15.

### Overturning levers

It's possible to fasten the lever on switches on straight or reverse side, maintaining the positive coupling.

In this way it is possible to obtain two different work plans of the lever.



### Rotating heads

In all switches, it is possible to rotate the head in 90° steps.



### Working operation of contact block 16 with independent contacts

The contact block 16 has two NC contacts, both with positive opening activated independently according to the lever turning direction.

Lever turned to left

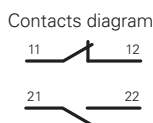

Lever not turned

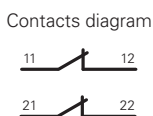

Lever turned to right

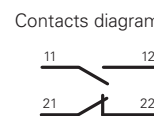

- 1
- 1A
- 1B
- 2
- 2A
- 2B
- 2C
- 2D
- 2E
- 3
- 3A
- 3B
- 3C
- 4
- 4A
- 4B
- 4C
- 4D
- 4E
- 4F
- 4G
- 4H
- 5
- 6

# 2B Position switches FR series

Contacts type:

- R** = snap action
- L** = slow action
- LO** = slow action overlapped
- LS** = slow action shifted
- LV** = slow action shifted and spaced
- LI** = slow action independent
- LA** = slow action closer
- ⏏** = electronic PNP

Contact blocks

		With external rubber gasket	With stainless steel roller on request	With external rubber gasket	With stainless steel roller on request			
5	<b>R</b> FR 501	→ 1NO+1NC	FR 5A1	→ 1NO+1NC	FR 502	→ 1NO+1NC	FR 5A2	→ 1NO+1NC
6	<b>L</b> FR 601	→ 1NO+1NC	FR 6A1	→ 1NO+1NC	FR 602	→ 1NO+1NC	FR 6A2	→ 1NO+1NC
7	<b>LO</b> FR 701	→ 1NO+1NC	FR 7A1	→ 1NO+1NC	FR 702	→ 1NO+1NC	FR 7A2	→ 1NO+1NC
9	<b>L</b> FR 901	→ 2NC	FR 9A1	→ 2NC	FR 902	→ 2NC	FR 9A2	→ 2NC
10	<b>L</b> FR 1001	2NO	FR 10A1	2NO	FR 1002	2NO	FR 10A2	2NO
11	<b>R</b> FR 1101	→ 2NC	FR 11A1	→ 2NC	FR 1102	→ 2NC	FR 11A2	→ 2NC
12	<b>R</b> FR 1201	2NO	FR 12A1	2NO	FR 1202	2NO	FR 12A2	2NO
13	<b>LV</b> FR 1301	→ 2NC	FR 13A1	→ 2NC	FR 1302	→ 2NC	FR 13A2	→ 2NC
14	<b>LS</b> FR 1401	→ 2NC	FR 14A1	→ 2NC	FR 1402	→ 2NC	FR 14A2	→ 2NC
15	<b>LS</b> FR 1501	2NO	FR 15A1	2NO	FR 1502	2NO	FR 15A2	2NO
18	<b>LA</b> FR 1801	→ 1NO+1NC	FR 18A1	→ 1NO+1NC	FR 1802	→ 1NO+1NC	FR 18A2	→ 1NO+1NC
20	<b>L</b> FR 2001	→ 1NO+2NC	FR 20A1	→ 1NO+2NC	FR 2002	→ 1NO+2NC	FR 20A2	→ 1NO+2NC
21	<b>L</b> FR 2101	→ 3NC	FR 21A1	→ 3NC	FR 2102	→ 3NC	FR 21A2	→ 3NC
22	<b>L</b> FR 2201	→ 2NO+1NC	FR 22A1	→ 2NO+1NC	FR 2202	→ 2NO+1NC	FR 22A2	→ 2NO+1NC
2	<b>R</b> FR 201	2x(1NO-1NC)			FR 202	2x(1NO-1NC)		
E1	<b>⏏</b> FR E101	1NO-1NC	FR E1A1	1NO-1NC	FR E102	1NO-1NC	FR E1A2	1NO-1NC
Max speed	page 6/5 - type 4		page 6/5 - type 4		page 6/5 - type 3		page 6/5 - type 3	
Min. force	8 N (25 N →)		6 N (25 N →)		6 N (25 N →)		4,3 N (25 N →)	
Travel diagrams	page 6/6 - group 1		page 6/6 - group 1		page 6/6 - group 2		page 6/6 - group 2	

	With external rubber gasket	With stainless steel roller on request	With external rubber gasket	With stainless steel roller on request				
	With external rubber gasket	With stainless steel roller on request	With external rubber gasket	With stainless steel roller on request				
	With $\varnothing$ 12 mm stainless steel roller on request		With stainless steel roller on request					
Contact blocks								
5	<b>R</b> FR 5A4	→ 1NO+1NC	<b>FR 505</b>	→ 1NO+1NC	FR 5A5	→ 1NO+1NC	<b>FR 507</b>	→ 1NO+1NC
6	<b>L</b> FR 6A4	→ 1NO+1NC	FR 605	→ 1NO+1NC	FR 6A5	→ 1NO+1NC	FR 607	→ 1NO+1NC
7	<b>LO</b> FR 7A4	→ 1NO+1NC	FR 705	→ 1NO+1NC	FR 7A5	→ 1NO+1NC	FR 707	→ 1NO+1NC
9	<b>L</b> FR 9A4	→ 2NC	FR 905	→ 2NC	FR 9A5	→ 2NC	FR 907	→ 2NC
10	<b>L</b> FR 10A4	2NO	FR 1005	2NO	FR 10A5	2NO	FR 1007	2NO
11	<b>R</b> FR 11A4	→ 2NC	FR 1105	→ 2NC	FR 11A5	→ 2NC	FR 1107	→ 2NC
12	<b>R</b> FR 12A4	2NO	FR 1205	2NO	FR 12A5	2NO	FR 1207	2NO
13	<b>LV</b> FR 13A4	→ 2NC	FR 1305	→ 2NC	FR 13A5	→ 2NC	FR 1307	→ 2NC
14	<b>LS</b> FR 14A4	→ 2NC	FR 1405	→ 2NC	FR 14A5	→ 2NC	FR 1407	→ 2NC
15	<b>LS</b> FR 15A4	2NO	FR 1505	2NO	FR 15A5	2NO	FR 1507	2NO
18	<b>LA</b> FR 18A4	→ 1NO+1NC	FR 1805	→ 1NO+1NC	FR 18A5	→ 1NO+1NC	FR 1807	→ 1NO+1NC
20	<b>L</b> FR 20A4	→ 1NO+2NC	FR 2005	→ 1NO+2NC	FR 20A5	→ 1NO+2NC	FR 2007	→ 1NO+2NC
21	<b>L</b> FR 21A4	→ 3NC	FR 2105	→ 3NC	FR 21A5	→ 3NC	FR 2107	→ 3NC
22	<b>L</b> FR 22A4	→ 2NO+1NC	FR 2205	→ 2NO+1NC	FR 22A5	→ 2NO+1NC	FR 2207	→ 2NO+1NC
2	<b>R</b> FR 205	2x(1NO-1NC)			FR 2A5	2x(1NO-1NC)		
E1	<b>⏏</b> FR E1A4	1NO-1NC	FR E105	1NO-1NC	FR E1A5	1NO-1NC	FR E107	1NO-1NC
Max speed	page 6/5 - type 4		page 6/5 - type 3		page 6/5 - type 3		page 6/5 - type 3	
Min. force	6 N (25 N →)		6 N (25 N →)		4,3 N (25 N →)		4 N (25 N →)	
Travel diagrams	page 6/6 - group 1		page 6/6 - group 2		page 6/6 - group 2		page 6/6 - group 3	

Accessories See page 5/1

All measures in the drawings are in mm



- Contacts type:
- R** = snap action
  - L** = slow action
  - LO** = slow action overlapped
  - LS** = slow action shifted
  - LV** = slow action shifted and spaced
  - LI** = slow action independent
  - LA** = slow action closer
  - A** = electronic PNP

Contact blocks

	With external rubber gasket	With external rubber gasket	Fixed only by threaded head in vertical position	
5	<b>R</b> FR 5A7	FR 508	FR 510	FR 512
6	<b>L</b> FR 6A7	FR 608	FR 610	FR 612
7	<b>LO</b> FR 7A7	FR 708	FR 710	FR 712
9	<b>L</b> FR 9A7	FR 908	FR 910	FR 912
10	<b>L</b> FR 10A7	FR 1008	FR 1010	FR 1012
11	<b>R</b> FR 11A7	FR 1108	FR 1110	FR 1112
12	<b>R</b> FR 12A7	FR 1208	FR 1210	FR 1212
13	<b>LV</b> FR 13A7	FR 1308	FR 1310	FR 1312
14	<b>LS</b> FR 14A7	FR 1408	FR 1410	FR 1412
15	<b>LS</b> FR 15A7	FR 1508	FR 1510	FR 1512
18	<b>LA</b> FR 18A7	FR 1808	FR 1810	FR 1812
20	<b>L</b> FR 20A7	FR 2008	FR 2010	FR 2012
21	<b>L</b> FR 21A7	FR 2108	FR 2110	FR 2112
22	<b>L</b> FR 22A7	FR 2208	FR 2210	FR 2212
2	<b>R</b> FR 2A7	FR 208	FR 210	FR 212
E1	<b>A</b> FR E1A7	FR E108	FR E110	FR E112
Max speed	page 6/5 - type 3	page 6/5 - type 4	page 6/5 - type 4	page 6/5 - type 4
Min. force	3 N (25 N ⊕)	8 N (25 N ⊕)	8 N (25 N ⊕)	8 N (25 N ⊕)
Travel diagrams	page 6/6 - group 3	page 6/6 - group 1	page 6/6 - group 1	page 6/6 - group 1

	Ø 11 mm polymer roller	Ø 12 mm stainless steel roller	
5	<b>R</b> FR 513	FR 514	FR 515-1
6	<b>L</b> FR 613	FR 614	FR 615-1
7	<b>LO</b> FR 713	FR 714	FR 715-1
9	<b>L</b> FR 913	FR 914	FR 915-1
10	<b>L</b> FR 1013	FR 1014	FR 1015-1
11	<b>R</b> FR 1113	FR 1114	FR 1115-1
12	<b>R</b> FR 1213	FR 1214	FR 1215-1
13	<b>LV</b> FR 1313	FR 1314	FR 1315-1
14	<b>LS</b> FR 1413	FR 1414	FR 1415-1
15	<b>LS</b> FR 1513	FR 1514	FR 1515-1
18	<b>LA</b> FR 1813	FR 1814	FR 1815-1
20	<b>L</b> FR 2013	FR 2014	FR 2015-1
21	<b>L</b> FR 2113	FR 2114	FR 2115-1
22	<b>L</b> FR 2213	FR 2214	FR 2215-1
2	<b>R</b> FR 213	FR 214	FR 215-1
E1	<b>A</b> FR E113	FR E114	FR E115-1
Max speed	page 6/5 - type 2	page 6/5 - type 4	page 6/5 - type 2
Min. force	8 N (25 N ⊕)	8 N (25 N ⊕)	8 N (25 N ⊕)
Travel diagrams	page 6/6 - group 1	page 6/6 - group 1	page 6/6 - group 1

Items with code on the green background are available in stock

# 2B Position switches FR series

Contacts type:

- R** = snap action
- L** = slow action
- LO** = slow action overlapped
- LS** = slow action shifted
- LV** = slow action shifted and spaced
- LI** = slow action independent
- LA** = slow action closer
- ⏏** = electronic PNP

Contact blocks

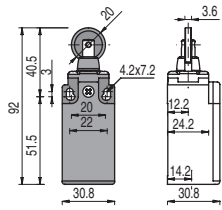

Fixed only by threaded head in vertical position

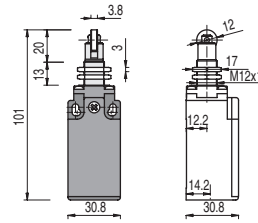

With external rubber gasket

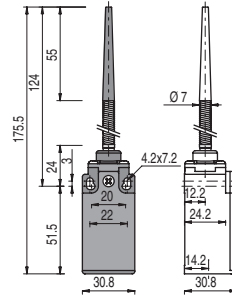

With external rubber gasket

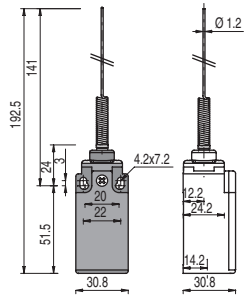

5	<b>R</b>	FR 516	⊕ 1NO+1NC	FR 517	⊕ 1NO+1NC	FR 520	1NO+1NC	FR 521	1NO+1NC
6	<b>L</b>	FR 616	⊕ 1NO+1NC	FR 617	⊕ 1NO+1NC				
7	<b>LO</b>	FR 716	⊕ 1NO+1NC	FR 717	⊕ 1NO+1NC				
9	<b>L</b>	FR 916	⊕ 2NC	FR 917	⊕ 2NC				
10	<b>L</b>	FR 1016	2NO	FR 1017	2NO	FR 1020	2NO	FR 1021	2NO
11	<b>R</b>	FR 1116	⊕ 2NC	FR 1117	⊕ 2NC				
12	<b>R</b>	FR 1216	2NO	FR 1217	2NO	FR 1220	2NO	FR 1221	2NO
13	<b>LV</b>	FR 1316	⊕ 2NC	FR 1317	⊕ 2NC				
14	<b>LS</b>	FR 1416	⊕ 2NC	FR 1417	⊕ 2NC				
15	<b>LS</b>	FR 1516	2NO	FR 1517	2NO				
18	<b>LA</b>	FR 1816	⊕ 1NO+1NC	FR 1817	⊕ 1NO+1NC	FR 1820	1NO+1NC	FR 1821	1NO+1NC
20	<b>L</b>	FR 2016	⊕ 1NO+2NC	FR 2017	⊕ 1NO+2NC	FR 2020	1NO+2NC	FR 2021	1NO+2NC
21	<b>L</b>	FR 2116	⊕ 3NC	FR 2117	⊕ 3NC	FR 2120	3NC	FR 2121	3NC
22	<b>L</b>	FR 2216	⊕ 2NO+1NC	FR 2217	⊕ 2NO+1NC	FR 2220	2NO+1NC	FR 2221	2NO+1NC
2	<b>R</b>	FR 216	2x(1NO-1NC)	FR 217	2x(1NO-1NC)	FR 220	2x(1NO-1NC)	FR 221	2x(1NO-1NC)
E1	<b>⏏</b>	FR E116	1NO-1NC	FR E117	1NO-1NC	FR E120	1NO-1NC	FR E121	1NO-1NC
Max speed		page 6/5 - type 2		page 6/5 - type 2		1 m/s		1 m/s	
Min. force		8 N (25 N ⊕)		8 N (25 N ⊕)		0,07 Nm		0,07 Nm	
Travel diagrams		page 6/6 - group 1		page 6/6 - group 1		page 6/6 - group 4		page 6/6 - group 4	

With external rubber gasket

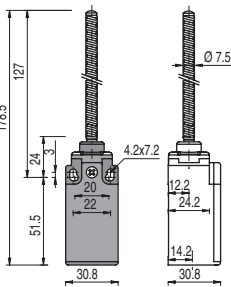

With Ø 20 mm stainless steel roller on request

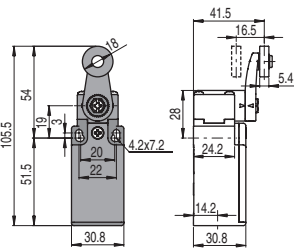

Other rollers available. See page 2/52

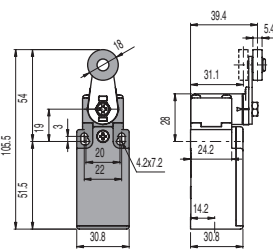

3x3 mm square rod

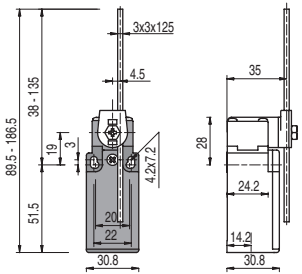

Contact blocks

5	<b>R</b>	FR 525	1NO+1NC	FR 530	⊕ 1NO+1NC	FR 531	⊕ 1NO+1NC	FR 533	1NO+1NC
6	<b>L</b>			FR 630	⊕ 1NO+1NC	FR 631	⊕ 1NO+1NC	FR 633	1NO+1NC
7	<b>LO</b>			FR 730	⊕ 1NO+1NC	FR 731	⊕ 1NO+1NC	FR 733	1NO+1NC
9	<b>L</b>			FR 930	⊕ 2NC	FR 931	⊕ 2NC	FR 933	2NC
10	<b>L</b>	FR 1025	2NO	FR 1030	2NO	FR 1031	2NO	FR 1033	2NO
11	<b>R</b>			FR 1130	⊕ 2NC	FR 1131	⊕ 2NC	FR 1133	2NC
12	<b>R</b>	FR 1225	2NO	FR 1230	2NO	FR 1231	2NO	FR 1233	2NO
13	<b>LV</b>			FR 1330	⊕ 2NC	FR 1331	⊕ 2NC	FR 1333	2NC
14	<b>LS</b>			FR 1430	⊕ 2NC	FR 1431	⊕ 2NC	FR 1433	2NC
15	<b>LS</b>			FR 1530	2NO	FR 1531	2NO	FR 1533	2NO
16	<b>LI</b>			FR 1630	⊕ 2NC	FR 1631	⊕ 2NC	FR 1633	2NC
18	<b>LA</b>	FR 1825	1NO+1NC	FR 1830	⊕ 1NO+1NC	FR 1831	⊕ 1NO+1NC	FR 1833	1NO+1NC
20	<b>L</b>	FR 2025	1NO+2NC	FR 2030	⊕ 1NO+2NC	FR 2031	⊕ 1NO+2NC	FR 2033	1NO+2NC
21	<b>L</b>	FR 2125	3NC	FR 2130	⊕ 3NC	FR 2131	⊕ 3NC	FR 2133	3NC
22	<b>L</b>	FR 2225	2NO+1NC	FR 2230	⊕ 2NO+1NC	FR 2231	⊕ 2NO+1NC	FR 2233	2NO+1NC
2	<b>R</b>	FR 225	2x(1NO-1NC)	FR 230	2x(1NO-1NC)	FR 231	2x(1NO-1NC)	FR 233	2x(1NO-1NC)
E1	<b>⏏</b>	FR E125	1NO-1NC	FR E130	1NO-1NC	FR E131	1NO-1NC	FR E133	1NO-1NC
Max speed		1 m/s		page 6/5 - type 1		page 6/5 - type 1		1,5 m/s	
Min. force		0,12 Nm		0,06 Nm (0,25 Nm ⊕)		0,06 Nm (0,25 Nm ⊕)		0,06 Nm	
Travel diagrams		page 6/6 - group 4		page 6/6 - group 5		page 6/6 - group 5		page 6/6 - group 5	

Accessories See page 5/1



Contacts type:

- R** = snap action
- L** = slow action
- LO** = slow action overlapped
- LS** = slow action shifted
- LV** = slow action shifted and spaced
- LI** = slow action independent
- LA** = slow action closer
- A** = electronic PNP

Contact blocks

			Ø 3 mm stainless steel round rod	Other rollers available. See page 2/52	Other rollers available. See page 2/52				
5	<b>R</b>	FR 534	1NO+1NC	FR 550	1NO+1NC	FR 551	➔ 1NO+1NC	FR 552	➔ 1NO+1NC
6	<b>L</b>	FR 634	1NO+1NC	FR 650	1NO+1NC	FR 651	➔ 1NO+1NC	FR 652	➔ 1NO+1NC
7	<b>LO</b>	FR 734	1NO+1NC	FR 750	1NO+1NC	FR 751	➔ 1NO+1NC	FR 752	➔ 1NO+1NC
9	<b>L</b>	FR 934	2NC	FR 950	2NC	FR 951	➔ 2NC	FR 952	➔ 2NC
10	<b>L</b>	FR 1034	2NO	FR 1050	2NO	FR 1051	2NO	FR 1052	2NO
11	<b>R</b>	FR 1134	2NC	FR 1150	2NC	FR 1151	➔ 2NC	FR 1152	➔ 2NC
12	<b>R</b>	FR 1234	2NO	FR 1250	2NO	FR 1251	2NO	FR 1252	2NO
13	<b>LV</b>	FR 1334	2NC	FR 1350	2NC	FR 1351	➔ 2NC	FR 1352	➔ 2NC
14	<b>LS</b>	FR 1434	2NC	FR 1450	2NC	FR 1451	➔ 2NC	FR 1452	➔ 2NC
15	<b>LS</b>	FR 1534	2NO	FR 1550	2NO	FR 1551	2NO	FR 1552	2NO
16	<b>LI</b>	FR 1634	2NC	FR 1650	2NC	FR 1651	➔ 2NC	FR 1652	➔ 2NC
18	<b>LA</b>	FR 1834	1NO+1NC	FR 1850	1NO+1NC	FR 1851	➔ 1NO+1NC	FR 1852	➔ 1NO+1NC
20	<b>L</b>	FR 2034	1NO+2NC	FR 2050	1NO+2NC	FR 2051	➔ 1NO+2NC	FR 2052	➔ 1NO+2NC
21	<b>L</b>	FR 2134	3NC	FR 2150	3NC	FR 2151	➔ 3NC	FR 2152	➔ 3NC
22	<b>L</b>	FR 2234	2NO+1NC	FR 2250	2NO+1NC	FR 2251	➔ 2NO+1NC	FR 2252	➔ 2NO+1NC
2	<b>R</b>	FR 234	2x(1NO-1NC)	FR 250	2x(1NO-1NC)	FR 251	2x(1NO-1NC)	FR 252	2x(1NO-1NC)
E1	<b>A</b>	FR E134	1NO-1NC	FR E150	1NO-1NC	FR E151	1NO-1NC	FR E152	1NO-1NC
Max speed		1,5 m/s	1,5 m/s	page 6/5 - type 1	page 6/5 - type 1	0,06 Nm (0,25 Nm ➔)	0,06 Nm (0,25 Nm ➔)	0,06 Nm (0,25 Nm ➔)	0,06 Nm (0,25 Nm ➔)
Min. force		0,06 Nm	0,06 Nm	0,06 Nm (0,25 Nm ➔)	0,06 Nm (0,25 Nm ➔)				
Travel diagrams		page 6/6 - group 5	page 6/6 - group 5	page 6/6 - group 5	page 6/6 - group 5				

		Porcelain roller	Other rollers available. See page 2/52	Other rollers available. See page 2/52	Other rollers available. See page 2/52				
5	<b>R</b>	FR 553-E0V9	➔ 1NO+1NC	FR 554	➔ 1NO+1NC	FR 555	➔ <sup>(1)</sup> 1NO+1NC	FR 556	➔ 1NO+1NC
6	<b>L</b>	FR 653-E0V9	➔ 1NO+1NC	FR 654	➔ 1NO+1NC	FR 655	➔ <sup>(1)</sup> 1NO+1NC	FR 656	➔ 1NO+1NC
7	<b>LO</b>	FR 753-E0V9	➔ 1NO+1NC	FR 754	➔ 1NO+1NC	FR 755	➔ <sup>(1)</sup> 1NO+1NC	FR 756	➔ 1NO+1NC
9	<b>L</b>	FR 953-E0V9	➔ 2NC	FR 954	➔ 2NC	FR 955	➔ <sup>(1)</sup> 2NC	FR 956	➔ 2NC
10	<b>L</b>	FR 1053-E0V9	2NO	FR 1054	2NO	FR 1055	2NO	FR 1056	2NO
11	<b>R</b>	FR 1253-E0V9	2NO	FR 1154	➔ 2NC	FR 1155	➔ <sup>(1)</sup> 2NC	FR 1156	➔ 2NC
12	<b>R</b>	FR 1253-E0V9	2NO	FR 1254	2NO	FR 1255	2NO	FR 1256	2NO
13	<b>LV</b>	FR 1353-E0V9	➔ 2NC	FR 1354	➔ 2NC	FR 1355	➔ <sup>(1)</sup> 2NC	FR 1356	➔ 2NC
14	<b>LS</b>	FR 1453-E0V9	➔ 2NC	FR 1454	➔ 2NC	FR 1455	➔ <sup>(1)</sup> 2NC	FR 1456	➔ 2NC
15	<b>LS</b>	FR 1553-E0V9	2NO	FR 1554	2NO	FR 1555	2NO	FR 1556	2NO
16	<b>LI</b>	FR 1653-E0V9	➔ 2NC	FR 1654	➔ 2NC	FR 1655	➔ <sup>(1)</sup> 2NC	FR 1656	➔ 2NC
18	<b>LA</b>	FR 1853-E0V9	➔ 1NO+1NC	FR 1854	➔ 1NO+1NC	FR 1855	➔ <sup>(1)</sup> 1NO+1NC	FR 1856	➔ 1NO+1NC
20	<b>L</b>	FR 2053-E0V9	➔ 1NO+2NC	FR 2054	➔ 1NO+2NC	FR 2055	➔ <sup>(1)</sup> 1NO+2NC	FR 2056	➔ 1NO+2NC
21	<b>L</b>	FR 2153-E0V9	➔ 3NC	FR 2154	➔ 3NC	FR 2155	➔ <sup>(1)</sup> 3NC	FR 2156	➔ 3NC
22	<b>L</b>	FR 2253-E0V9	➔ 2NO+1NC	FR 2254	➔ 2NO+1NC	FR 2255	➔ <sup>(1)</sup> 2NO+1NC	FR 2256	➔ 2NO+1NC
2	<b>R</b>	FR 253-E0	2x(1NO-1NC)	FR 254	2x(1NO-1NC)	FR 255	2x(1NO-1NC)	FR 256	2x(1NO-1NC)
E1	<b>A</b>	FR E153-E0V9	1NO-1NC	FR E154	1NO-1NC	FR E155	1NO-1NC	FR E156	1NO-1NC
Max speed		0,5 m/s	page 6/5 - type 1	page 6/5 - type 1	page 6/5 - type 1	0,06 Nm (0,25 Nm ➔)	0,06 Nm (0,25 Nm ➔)	0,06 Nm (0,25 Nm ➔)	0,06 Nm (0,25 Nm ➔)
Min. force		0,03 Nm (0,25 Nm ➔)	0,06 Nm (0,25 Nm ➔)	0,06 Nm (0,25 Nm ➔)	0,06 Nm (0,25 Nm ➔)				
Travel diagrams		page 6/6 - group 6	page 6/6 - group 5	page 6/6 - group 5	page 6/6 - group 5				

Items with code on the green background are available in stock

<sup>(1)</sup> Positive opening only with lever adjusted on the max. See page 2/51



# 2B Position switches FR series

Contacts type:

- R** = snap action
- L** = slow action
- LO** = slow action overlapped
- LS** = slow action shifted
- LV** = slow action shifted and spaced
- LI** = slow action independent
- LA** = slow action closer
- A** = electronic PNP

Contact blocks

Other rollers available. See page 2/52

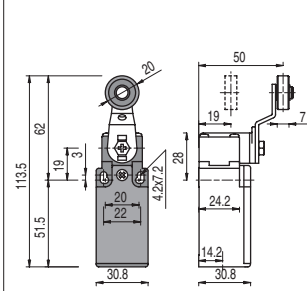

Fiber glass rod

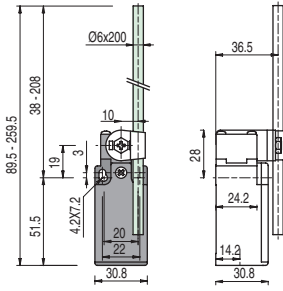

Rope switches for signalling

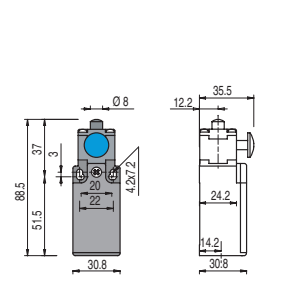
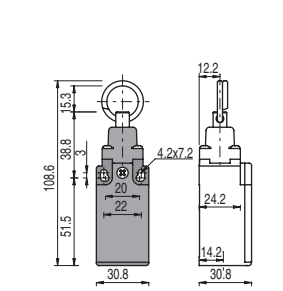

5	<b>R</b>	FR 557	⊕ 1NO+1NC	FR 569	1NO+1NC	FR 576	1NO+1NC	FR 501-72	⊕ 1NO+1NC
6	<b>L</b>	FR 657	⊕ 1NO+1NC	FR 669	1NO+1NC	FR 676	1NO+1NC		
7	<b>LO</b>	FR 757	⊕ 1NO+1NC	FR 769	1NO+1NC	FR 776	1NO+1NC		
9	<b>L</b>	FR 957	⊕ 2NC	FR 969	2NC	FR 976	2NO		
10	<b>L</b>	FR 1057	2NO	FR 1069	2NO	FR 1076	2NC	FR 1001-72	2NO
11	<b>R</b>	FR 1157	⊕ 2NC	FR 1169	2NC	FR 1176	2NO	This switch can be installed on doors of electrical boards. It is used to switch on possible signal devices, once the door is open (e.g. three-phase flashing devices, etc.) The operator assigned to the board maintenance may simulate the closing of the door by pushing the blue push button. At the end of the maintenance the functionality of the switch will be automatically reestablished easily by closing the door of the board.	
12	<b>R</b>	FR 1257	2NO	FR 1269	2NO	FR 1276	2NC		
13	<b>LV</b>	FR 1357	⊕ 2NC	FR 1369	2NC	FR 1376	2NO		
14	<b>LS</b>	FR 1457	⊕ 2NC	FR 1469	2NC	FR 1476	2NO		
15	<b>LS</b>	FR 1557	2NO	FR 1569	2NO	FR 1576	2NC		
16	<b>LI</b>	FR 1657	⊕ 2NC	FR 1669	2NC				
18	<b>LA</b>	FR 1857	⊕ 1NO+1NC	FR 1869	1NO+1NC	FR 1876	1NO+1NC		
20	<b>L</b>	FR 2057	⊕ 1NO+2NC	FR 2069	1NO+2NC	FR 2076	2NO+1NC		
21	<b>L</b>	FR 2157	⊕ 3NC	FR 2169	3NC	FR 2176	3NO		
22	<b>L</b>	FR 2257	⊕ 2NO+1NC	FR 2269	2NO+1NC	FR 2276	1NO+2NC		
2	<b>R</b>	FR 257	2x(1NO-1NC)	FR 269	2x(1NO-1NC)	FR 276	2x(1NO-1NC)		
E1	<b>A</b>	FR E157	1NO-1NC	FR E169	1NO-1NC				
Max speed		page 6/5 - type 1		1,5 m/s		0,5 m/s		page 6/5 - type 4	
Min. force		0,06 Nm (0,25 Nm ⊕)		0,06 Nm		initial 20 N - final 40 N		8 N (25 N ⊕)	
Travel diagrams		page 6/6 - group 5		page 6/6 - group 5		page 6/6 - group 7		page 6/6 - group 1	

## Position switches FR series with reset



Pizzato Elettrica has developed an innovative reset device code W3 to make perfectly simultaneous the actuator and the contact block tripping. The new device is a block inserted between the switch body and the head, and could be rotated independently from this last one. This new device has following advantages:

- \* The reset device integrate in any standard actuation head
- \* Contact blocks with snap action are no more necessary because the tripping movement is made by the reset device itself
- \* Unlike some previous versions, the reset device can be rotated independently from the head for the maximum flexibility during the assembling.

With stainless steel roller on request

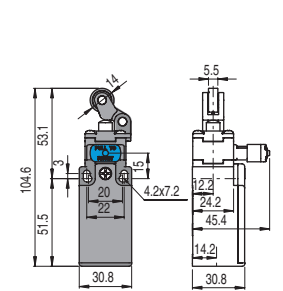

With stainless steel roller on request

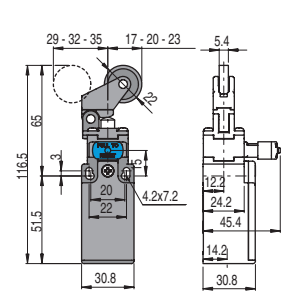
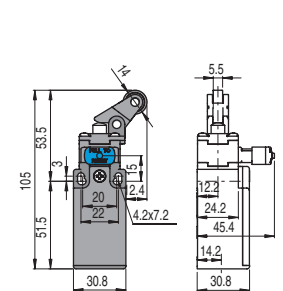

Contact blocks

6	<b>L</b>	FR 601-W3	⊕ 1NO+1NC	FR 602-W3	⊕ 1NO+1NC	FR 605-W3	⊕ 1NO+1NC	FR 607-W3	⊕ 1NO+1NC
9	<b>L</b>	FR 901-W3	⊕ 2NC	FR 902-W3	⊕ 2NC	FR 905-W3	⊕ 2NC	FR 907-W3	⊕ 2NC
10	<b>L</b>	FR 1001-W3	2NO	FR 1002-W3	2NO	FR 1005-W3	2NO	FR 1007-W3	2NO
20	<b>L</b>	FR 2001-W3	⊕ 1NO+2NC	FR 2002-W3	⊕ 1NO+2NC	FR 2005-W3	⊕ 1NO+2NC	FR 2007-W3	⊕ 1NO+2NC
21	<b>L</b>	FR 2101-W3	⊕ 3NC	FR 2102-W3	⊕ 3NC	FR 2105-W3	⊕ 3NC	FR 2107-W3	⊕ 3NC
22	<b>L</b>	FR 2201-W3	⊕ 2NO+1NC	FR 2202-W3	⊕ 2NO+1NC	FR 2205-W3	⊕ 2NO+1NC	FR 2207-W3	⊕ 2NO+1NC
2	<b>R</b>	FR 201-W3	2NO+2NC	FR 202-W3	2NO+2NC	FR 205-W3	2NO+2NC	FR 207-W3	2NO+2NC
Max speed		page 6/5 - type 4		page 6/5 - type 3		page 6/5 - type 3		page 6/5 - type 3	
Min. force		8 N (25 N ⊕)		6 N (25 N ⊕)		6 N (25 N ⊕)		4 N (25 N ⊕)	
Travel diagrams		page 6/7 - group 1		page 6/7 - group 2		page 6/7 - group 2		page 6/7 - group 3	

Accessories See page 5/1



Contacts type:

- R** = snap action
- L** = slow action

With stainless steel roller on request

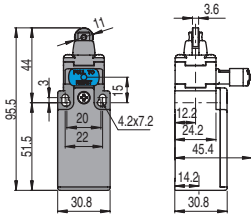

With Ø 20 mm stainless steel roller on request

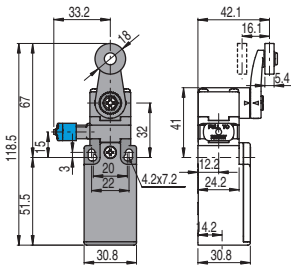

Other rollers available. See page 2/52

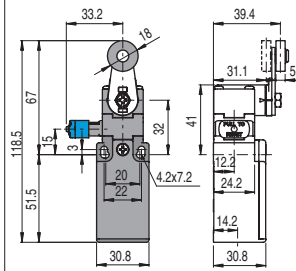

Other rollers available. See page 2/52

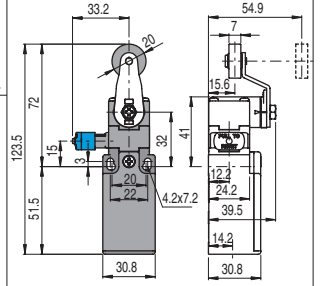

Contact blocks

6	<b>L</b>	FR 615-W3	➔ 1NO+1NC	FR 630-W3	➔ 1NO+1NC	FR 631-W3	➔ 1NO+1NC	FR 651-W3	➔ 1NO+1NC
9	<b>L</b>	FR 915-W3	➔ 2NC	FR 930-W3	➔ 2NC	FR 931-W3	➔ 2NC	FR 951-W3	➔ 2NC
10	<b>L</b>	FR 1015-W3	2NO	FR 1030-W3	2NO	FR 1031-W3	2NO	FR 1051-W3	2NO
20	<b>L</b>	FR 2015-W3	➔ 1NO+2NC	FR 2030-W3	➔ 1NO+2NC	FR 2031-W3	➔ 1NO+2NC	FR 2051-W3	➔ 1NO+2NC
21	<b>L</b>	FR 2115-W3	➔ 3NC	FR 2130-W3	➔ 3NC	FR 2131-W3	➔ 3NC	FR 2151-W3	➔ 3NC
22	<b>L</b>	FR 2215-W3	➔ 2NO+1NC	FR 2230-W3	➔ 2NO+1NC	FR 2231-W3	➔ 2NO+1NC	FR 2251-W3	➔ 2NO+1NC
2	<b>R</b>	FR 215-W3	2NO+2NC	FR 230-W3	2NO+2NC	FR 231-W3	2NO+2NC	FR 251-W3	2NO+2NC
Max speed		page 6/5 - type 2		page 6/5 - type 1		page 6/5 - type 1		page 6/5 - type 1	
Min. force		8 N (25 N ➔)		0,06 Nm (0,25 Nm ➔)		0,06 Nm (0,25 Nm ➔)		0,06 Nm (0,25 Nm ➔)	
Travel diagrams		page 6/7 - group 1		page 6/7 - group 4		page 6/7 - group 4		page 6/7 - group 4	

Other rollers available. See page 2/52

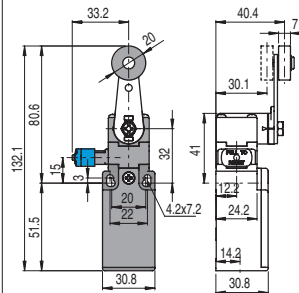

Other rollers available. See page 2/52

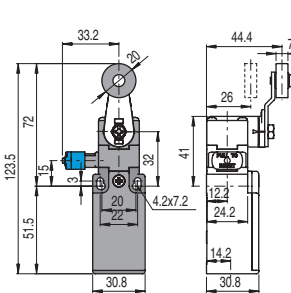

Other rollers available. See page 2/52

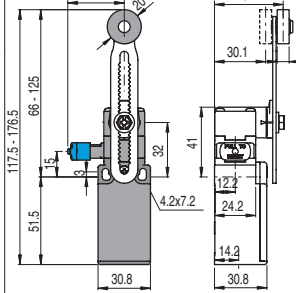

Other rollers available. See page 2/52

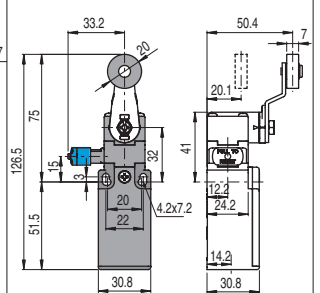

6	<b>L</b>	FR 652-W3	➔ 1NO+1NC	FR 654-W3	➔ 1NO+1NC	FR 656-W3	➔ 1NO+1NC	FR 657-W3	➔ 1NO+1NC
9	<b>L</b>	FR 952-W3	➔ 2NC	FR 954-W3	➔ 2NC	FR 956-W3	➔ 2NC	FR 957-W3	➔ 2NC
10	<b>L</b>	FR 1052-W3	2NO	FR 1054-W3	2NO	FR 1056-W3	2NO	FR 1057-W3	2NO
20	<b>L</b>	FR 2052-W3	➔ 1NO+2NC	FR 2054-W3	➔ 1NO+2NC	FR 2056-W3	➔ 1NO+2NC	FR 2057-W3	➔ 1NO+2NC
21	<b>L</b>	FR 2152-W3	➔ 3NC	FR 2154-W3	➔ 3NC	FR 2156-W3	➔ 3NC	FR 2157-W3	➔ 3NC
22	<b>L</b>	FR 2252-W3	➔ 2NO+1NC	FR 2254-W3	➔ 2NO+1NC	FR 2256-W3	➔ 2NO+1NC	FR 2257-W3	➔ 2NO+1NC
2	<b>R</b>	FR 252-W3	2NO+2NC	FR 254-W3	2NO+2NC	FR 256-W3	2NO+2NC	FR 257-W3	2NO+2NC
Max speed		page 6/5 - type 1		page 6/5 - type 1		page 6/5 - type 1		page 6/5 - type 1	
Min. force		0,06 Nm (0,25 Nm ➔)		0,06 Nm (0,25 Nm ➔)		0,06 Nm (0,25 Nm ➔)		0,06 Nm (0,25 Nm ➔)	
Travel diagrams		page 6/7 - group 4		page 6/7 - group 4		page 6/7 - group 4		page 6/7 - group 4	

Items with code on the green background are available in stock

## Position switches with revolving lever without actuator

Contacts type:

- R** = snap action
- L** = slow action
- LO** = slow action overlapped
- LS** = slow action shifted
- LV** = slow action shifted and spaced
- LI** = slow action independent
- LA** = slow action closer
- ⏏** = electronic PNP

Contact blocks

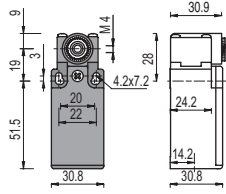

with manual reset knob

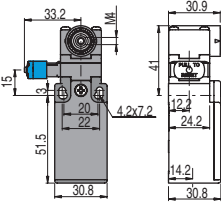

### IMPORTANT

**For safety applications:** join only switches and actuators marked with symbol ⊕.  
For more information about safety applications see page 6/1.

5	<b>R</b>	<b>FR 538</b> ⊕	1NO+1NC	
6	<b>L</b>	<b>FR 638</b> ⊕	1NO+1NC	<b>FR 638-W3</b> ⊕ 1NO+1NC
7	<b>LO</b>	<b>FR 738</b> ⊕	1NO+1NC	
9	<b>L</b>	<b>FR 938</b> ⊕	2NC	<b>FR 938-W3</b> ⊕ 2NC
10	<b>L</b>	<b>FR 1038</b>	2NO	<b>FR 1038-W3</b> 2NO
11	<b>R</b>	<b>FR 1138</b> ⊕	2NC	
12	<b>R</b>	<b>FR 1238</b>	2NO	
13	<b>LV</b>	<b>FR 1338</b> ⊕	2NC	
14	<b>LS</b>	<b>FR 1438</b> ⊕	2NC	
15	<b>LS</b>	<b>FR 1538</b>	2NO	
16	<b>LI</b>	<b>FR 1638</b> ⊕	2NC	
18	<b>LA</b>	<b>FR 1838</b> ⊕	1NO+1NC	
20	<b>L</b>	<b>FR 2038</b> ⊕	1NO+2NC	<b>FR 2038-W3</b> ⊕ 1NO+2NC
21	<b>L</b>	<b>FR 2138</b> ⊕	3NC	<b>FR 2138-W3</b> ⊕ 3NC
22	<b>L</b>	<b>FR 2238</b> ⊕	2NO+1NC	<b>FR 2238-W3</b> ⊕ 2NO+1NC
2	<b>R</b>	<b>FR 238</b>	2x(1NO-1NC)	<b>FR 238-W3</b> 2NO+2NC
E1	<b>⏏</b>	<b>FR E138</b>	1NO-1NC	
Min. force		0,06 Nm (0,25 Nm ⊕)		0,06 Nm (0,25 Nm ⊕)
Travel diagrams		page 6/6 - group 5		page 6/7 - group 4

## Loose actuators

10 pcs pack

**IMPORTANT:** These loose actuators can be used with items of series FR, FM, FX, FZ, FK only

Ø 18 mm roller	Ø 18 mm roller	Adjustable square rod 3x3x125 mm	Flexible rod actuator	Adjustable round rod Ø 3x125 mm	Polymer roller Ø 20 mm	
<b>VF LE30</b> ⊕	<b>VF LE31</b> ⊕	<b>VF LE33</b>	<b>VF LE34</b>	<b>VF LE50</b>	<b>VF LE51</b> ⊕	
Polymer roller Ø 20 mm	Porcelain roller	Polymer roller Ø 20 mm	Adjustable actuator with polymer roller	Adjustable safety actuator with polymer roller	Polymer roller Ø 20 mm	Adjustable fiber glass rod
<b>VF LE52</b> ⊕	<b>VF LE53</b> ⊕ (2)	<b>VF LE54</b> ⊕	<b>VF LE55</b> ⊕ (1)	<b>VF LE56</b> ⊕	<b>VF LE57</b> ⊕	<b>VF LE69</b>

- Only orders for multiple quantities of the packs are accepted.

(1) Actuator VF LE55 suits to safety applications only if adjusted to its max length, as you can see in figure beside. If you need an adjustable lever for safety applications, use the adjustable safety lever VF LE56.

(2) The position switch obtained by assembling the switch FR •38 (e.g. FR 538, FR 638) with the actuator VF LE53 will not present the same travel diagrams and actuating forces as the position switch FR •53-E0V9 (e.g. FR 553-E0V9, FR 653-E0V9...).

(4) The actuator cannot be oriented to inside direction because it will mechanically interfere with the switch head.

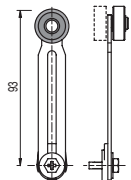

Accessories See page 5/1



### Special loose actuators

10 pcs pack

**IMPORTANT:** These loose actuators can be used with items of series FR, FM, FX, FZ, FK only

Ø 20 mm stainless steel rollers

VF LE31-1 (1)	VF LE51-1 (1)	VF LE52-1 (1)	VF LE54-1 (1)	VF LE55-1 (1) (1)	VF LE56-1 (1)	VF LE57-1 (1)

Ø 35 mm polymer rollers

VF LE31-2 (4)	VF LE51-2 (4)	VF LE52-2 (4)	VF LE54-2 (4)	VF LE55-2 (1) (1)	VF LE56-2 (4)	VF LE57-2 (4)

Ø 40 mm rubber rollers

VF LE31-R5 (4)	VF LE51-R5 (4)	VF LE52-R5 (4)	VF LE54-R5 (4)	VF LE55-R5 (1) (1)	VF LE56-R5 (4)	VF LE57-R5 (4)

Ø 50 mm rubber rollers



VF LE51-3 (4)	VF LE52-3 (4)	VF LE54-3 (4)	VF LE55-3 (1) (1)	VF LE56-3 (4)	VF LE57-3 (4)

Ø 50 mm overhanging rubber rollers

VF LE55-4 (1) (1)	VF LE56-4 (1) (1)

Items with code on the green background are available in stock

### Installation of single switches for safety applications

- Use only switches with the symbol  (see figure on the side).
- Connect the safety circuit to **the NC normally closed contacts (11-12, 21-22 or 31-32).**
- **The NO normally open contacts (13-14, 23-24, 33-34) should be used only for signalling;** these contacts are not to be connected with the safety circuit. However, if in the same protection two or more switches are used, it is possible to connect the contact NO to safety circuit.
- **The switch must be actuated with the minimum positive opening travel** indicated in the travel diagrams with symbol .
- **The switch must be actuated with the minimum positive opening force** indicated in brackets below every article, near the value of the min. force.



When the machine guard has been open and during the whole opening travel, **the switch must be triggered directly** (fig. 1) **or through a rigid connection** (fig. 2).

Only in this way the positive opening of the NC normally closed contacts (11-12, 21-22, 31-32) is guaranteed.

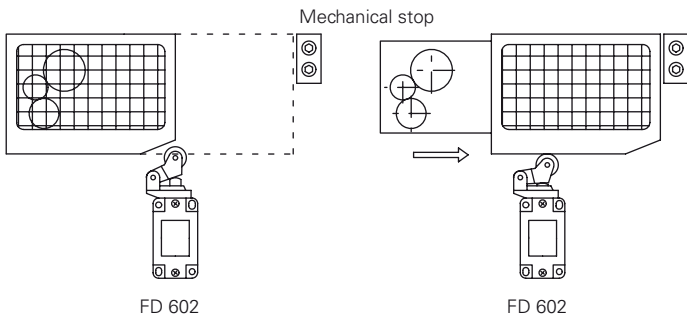

Fig.1

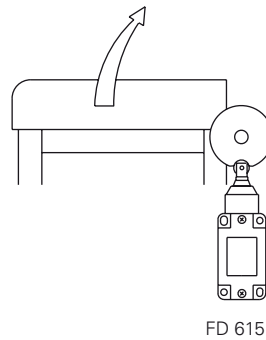
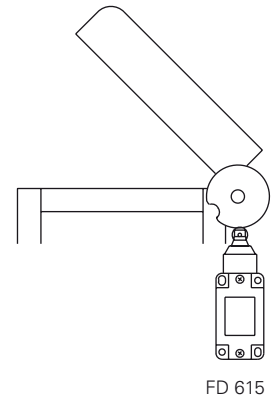

Fig.2



FD 615

In the safety application with only one switch for each guard, the switches **should not be applied to activate by release** (fig. 3 and 4) **or through a non rigid connection** (i.e. by a spring).

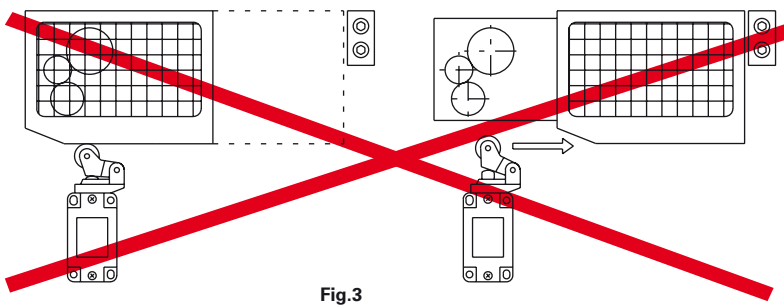

Fig.3

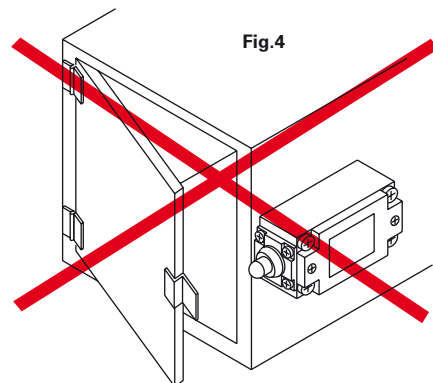
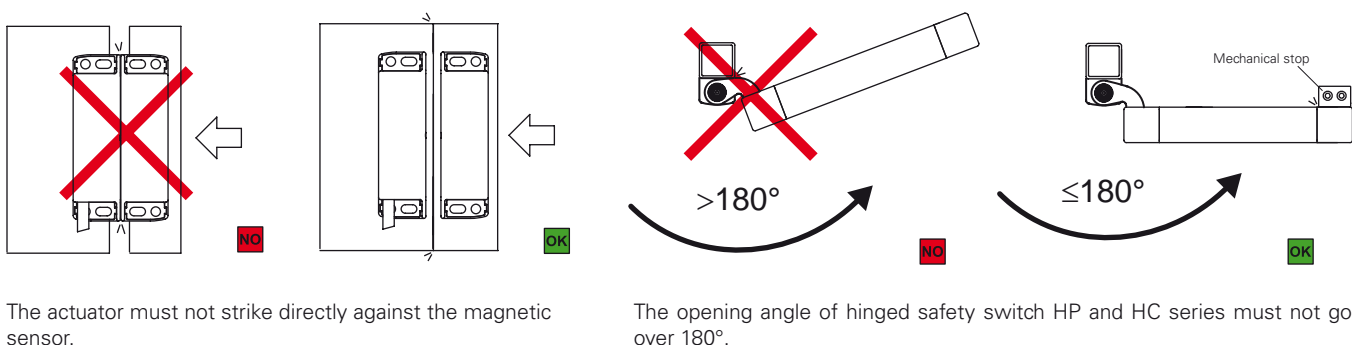
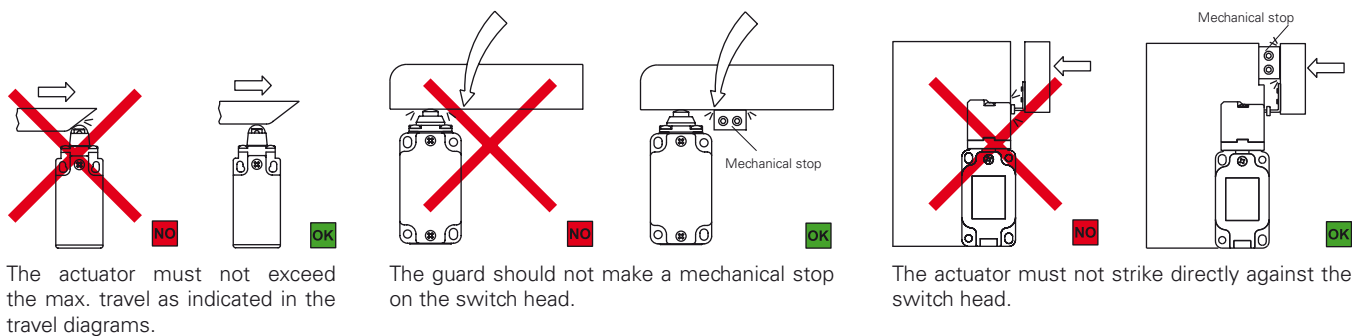

Fig.4

**Mechanical stop**

In accordance with the EN 1088 standard, paragraph 5.2.2., "the position sensors should not be used as mechanical stop"



**Actuation modality**

Recommended application	Application to avoid <small>Possible application but with mechanical stress for the switch higher than expected, mechanical endurance is not guaranteed</small>	Forbidden application

**Maximum and minimum actuation speed: switches for heavy duty FD-FL-FP-FC series**
**Type 1**

Lever with roller

$\phi$	Vmax (m/s)	Vmin (mm/s) L	Vmin (mm/s) R
15°	2,5	9	0,07
30°	1,5	8	
45°	1	7	
60°	0,75	7	

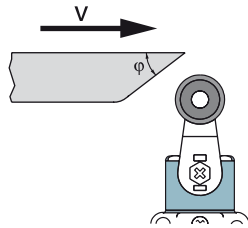
**Type 2**

Plunger with roller

$\phi$	Vmax (m/s)	Vmin (mm/s) L	Vmin (mm/s) R
15°	1	4	0,04
30°	0,5	2	0,02
45°	0,3	1	0,01

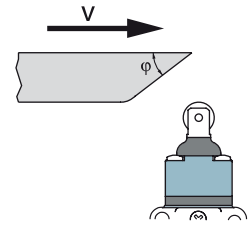
**Type 3**

Lever with roller

$\phi$	Vmax (m/s)	Vmin (mm/s) L	Vmin (mm/s) R
15°	1	5	0,05
30°	0,5	2,5	0,025
45°	0,3	1,5	0,015

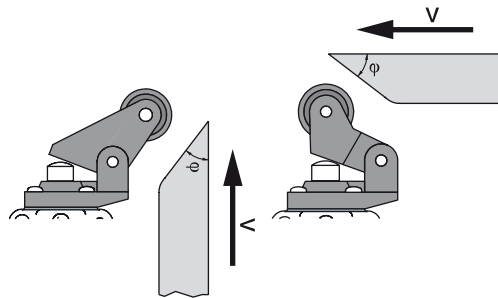
**Type 4**

Plunger

Vmax (m/s)	Vmin (mm/s) L	Vmin (mm/s) R
0,5	1	0,01

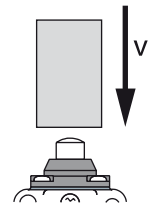

Contacts type:

**R** = snap action  
**L** = slow action

**Screw driving torques: switches for heavy duty FD-FL-FP-FC-FG-FS-FT series**

Cover screws <b>1</b>	<b>0,8 ... 1,2 Nm</b>
Head screws <b>2</b>	<b>0,8 ... 1,2 Nm</b>
Lever screws <b>3</b>	<b>0,8 ... 1,2 Nm</b>
Protection plugs <b>4</b>	<b>1,2 ... 2,0 Nm</b>
Contact blocks screws <b>5</b>	<b>0,6 ... 0,8 Nm</b>
M5 screws or the housing fastening with washer (FP-FS-FT series) <b>6</b>	<b>2... 3 Nm</b>

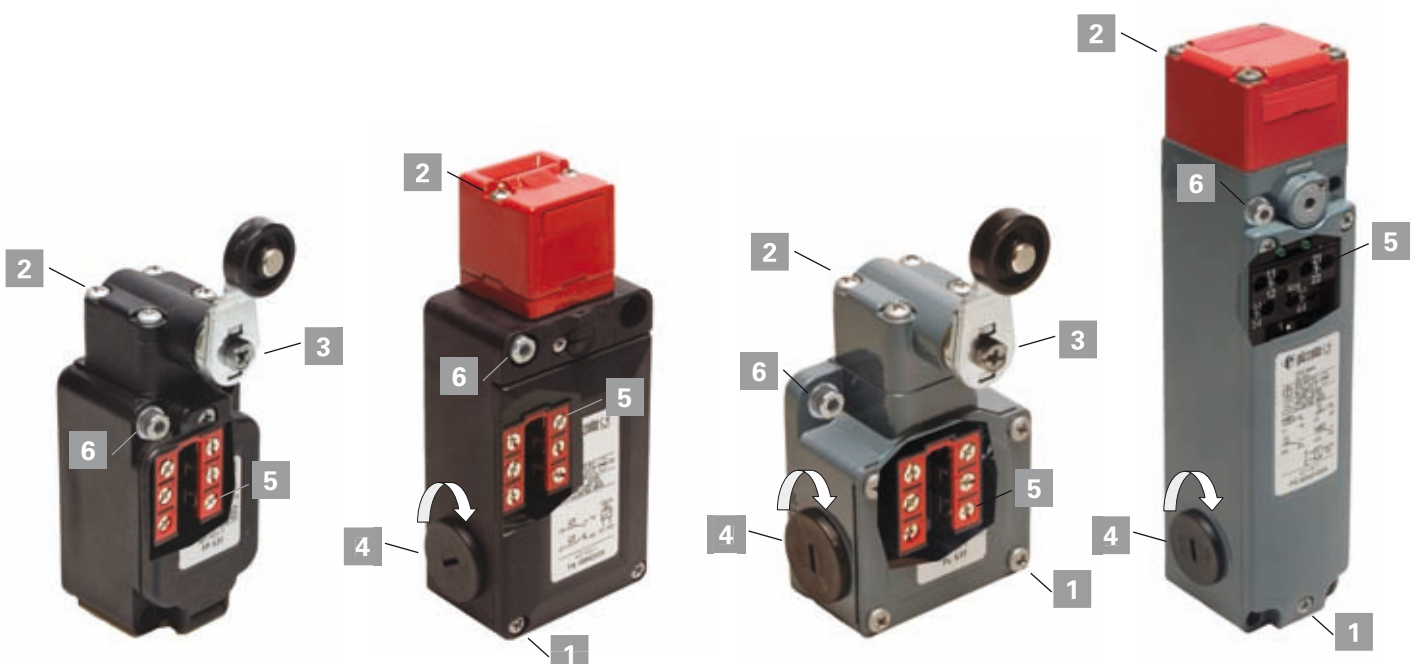

Travel diagrams table: position switches for heavy application FD - FP - FL - FC series

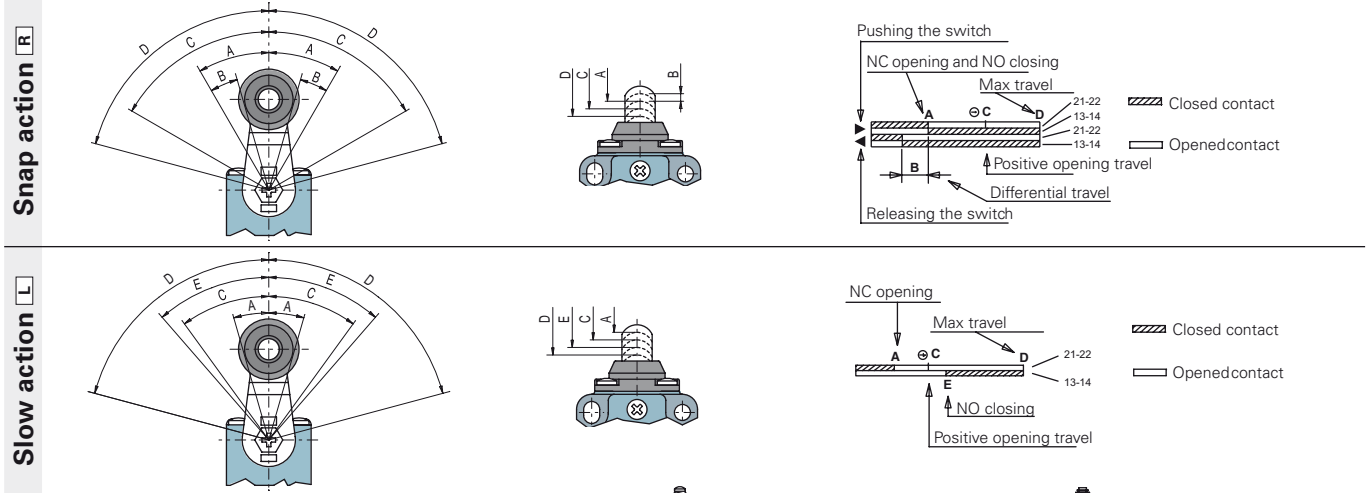

Contact block	Group 1	Group 2	Group 3	Group 4	Group 5	Group 6 inverted contacts
2 [R] 2x(1NO-1NC) 13 21 43 31 14 22 44 32	0 1.3 6 0.7	0 1.6 8 0.9	0 8° 4°	0 20° 75° 13°	0 20° 75° 13°	0 3.3 8 2.5
3 1NO-1NC 13 21 14 22	0 1.3 6 0.8	0 1.7 8 1.1	0 10° 5°	0 20° 75° 13°	0 20° 75° 13°	0 5.3 8 4.5
5 [R] 1NO+1NC 13 21 14 22	0 2.2 6 1.1	0 2.7 8 1.4	0 15° 5°	0 30° 60° 75° 17°	0 22° 52° 75° 9°	0 2.9 8 1.7
6 [L] 1NO+1NC 13 21 14 22	0 1.5 6 3.4	0 1.8 8 4.2		0 22° 42° 75° 42°	0 14° 34° 75° 34°	0 0.8 8 2.3
7 [LO] 1NO+1NC 13 21 14 22	0 3.1 6 1.6	0 3.8 8 2		0 40° 60° 75° 23°	0 32° 52° 75° 15°	0 2.2 8 1
9 [L] 2NC 11 21 12 22	0 2.9 6 4.4	0 3.6 8 5.4		0 40° 60° 75°	0 32° 52° 75°	0 1 8
10 [L] 2NO 13 23 14 24	0 1.4 6	0 1.7 8	0 9°	0 22° 75°	0 14° 75°	0 2.5 8
11 [R] 2NC 11 21 12 22	0 2 6 0.6	0 2.5 8 0.7		0° 27° 57° 75° 11°		0 3.5 8 2.1
12 [R] 2NO 13 23 14 24	0 2.9 6 1.5	0 3.6 8 1.8	0 19° 7°	0 38° 75° 22°	0 30° 75° 14°	0 2.6 8 1.1
13 [LV] 2NC 11 21 12 22	0 3 6 0.8 2.3	0 3.7 8 1 2.8		0 41° 61° 75° 14° 34°	0 33° 53° 75° 6° 26°	0 3.2 8 1
14 2NC 11 21 12 22	0 3 6 1.4 2.9	0 3.7 8 1.7 3.6		0 40° 60° 75° 22° 42°	0 32° 52° 75° 14° 34°	0 2.5 8 0.9
15 2NO 13 23 14 24	0 3 6 1.4	0 3.7 8 1.7		0 40° 75° 22°	0 32° 75° 14°	0 2.6 8 1
16 2NC 11 21 12 22				75° 0 26° 46° 46° 26° 75°		
18 [L] 1NO+1NC 13 21 14 22	0 1.5 6 2	0 1.8 8 2.5	0 10° 13°	0 23° 43° 75° 29°	0 15° 35° 75° 21°	0 1.9 8 2.4
20 [L] 1NO+2NC 11 21 33 12 22 34	0 1.5 6 2	0 1.8 8 2.5	0 10° 13°	0 23° 43° 75° 29°	0 15° 35° 75° 21°	0 2.4 8 1.9
21 [L] 3NC 11 21 31 12 22 32	0 1.5 6 2	0 1.8 8 2.5	0 10° 13°	0 23° 43° 75° 29°	0 15° 35° 75° 21°	0 2.4 8 1.9
22 [L] 2NO+1NC 11 23 33 12 24 34	0 1.5 6 2	0 1.8 8 2.5	0 10° 13°	0 23° 43° 75° 29°	0 15° 35° 75° 21°	0 2.4 8 1.9
33 [L] 1NO+1NC 13 21 14 22	0 1.5 6 2	0 1.8 8 2.5	0 10° 12°	0 23° 43° 75° 27°	0 15° 35° 75° 19°	0 2.1 8 2.4
34 [L] 2NC 11 21 12 22	0 1.5 6 2	0 1.8 8 2.5	0 10°	0 23° 43° 75°	0 15° 35° 75°	0 2.4 8

All measures in the drawings are in mm or degrees



**Maximum and minimum actuation speed: switches for normal duty FR-FM-FX-FZ-FK series**
**Type 1**

Lever with roller

$\varphi$	Vmax (m/s)	Vmin (mm/s) L	Vmin (mm/s) R
15°	2,5	9	0,07
30°	1,5	8	
45°	1	7	
60°	0,75	7	

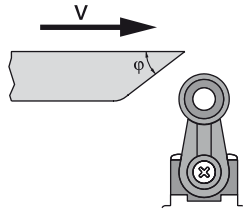
**Type 2**

Plunger with roller

$\varphi$	Vmax (m/s)	Vmin (mm/s) L	Vmin (mm/s) R
15°	1	4	0,04
30°	0,5	2	0,02
45°	0,3	1	0,01

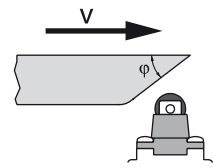
**Type 3**

Lever with roller

$\varphi$	Vmax (m/s)	Vmin (mm/s) L	Vmin (mm/s) R
15°	1	5	0,05
30°	0,5	2,5	0,025
45°	0,3	1,5	0,015

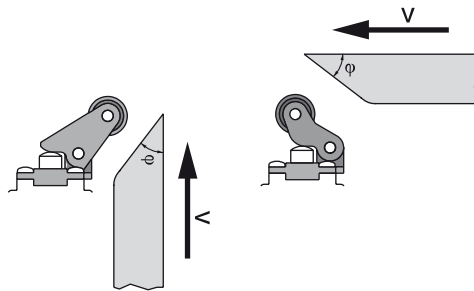
**Type 4**

Plunger

Vmax (m/s)	Vmin (mm/s) L	Vmin (mm/s) R
0,5	1	0,01

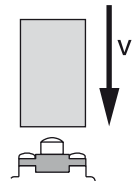

Contacts type:

**R** = snap action  
**L** = slow action

**Screw driving torques: switches for normal duty FR-FM-FX-FZ-FK-FW series**
**For FR, FX, FK and FW series only:**

- Cover screws **1**
- Head screws **2**
- Lever screws **3**
- Protection plugs **4**
- Contact blocks screws **5**
- M4 screws or the housing fastening with washer (FR-FX-FK series) **6**
- M5 screws or the housing fastening with washer (FW series) **7**

0,7 ... 0,9 Nm

0,7 ... 0,9 Nm

0,7 ... 0,9 Nm

1,2 ... 2,0 Nm

0,6 ... 0,8 Nm

2... 3 Nm

2... 3 Nm

**For FM and FZ series only:**

- Cover screws **1**
- Head screws **2**
- Lever screws **3**
- Protection plugs **4**
- Contact blocks screws **5**
- M5 screws or the housing fastening **6**

0,8 ... 1,2 Nm

0,8 ... 1,2 Nm

0,8 ... 1,2 Nm

1,2 ... 2,0 Nm

0,6 ... 0,8 Nm

2... 3 Nm

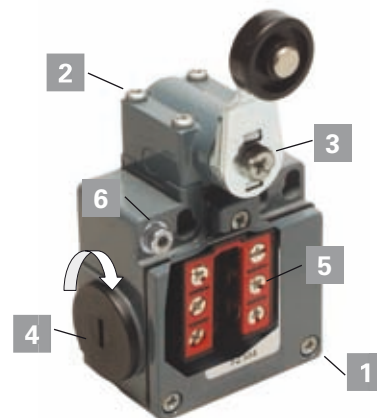
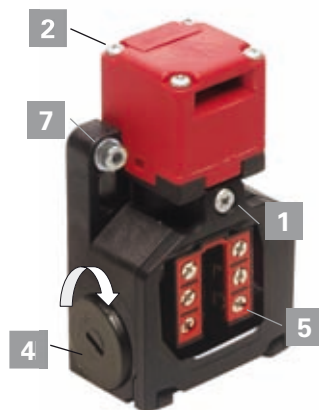
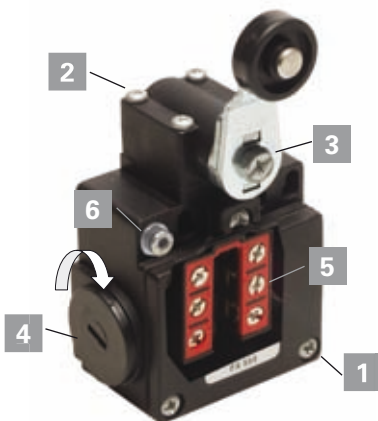

Travel diagrams table: position switches for normal application FR - FM - FX - FZ - FK series

Snap action **R**

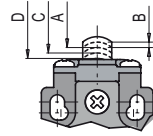
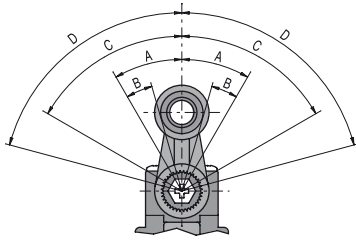

Pushing the switch

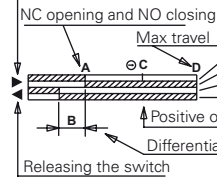

Closed contact  
 Opened contact

Slow action **L**

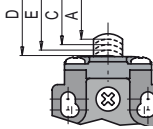
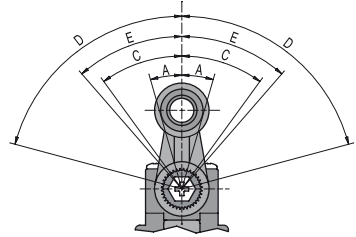

NC opening

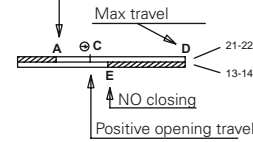

Closed contact  
 Opened contact

Contact block

Group 1

Group 2

Group 3

Group 4

Group 5

Group 6

Group 7  
inverted contacts

2 2x(1NO-1NC) 13 21 43 31 14 22 44 32							
3 1NO-1NC 13 21 14 22							
5 1NO+1NC 13 21 14 22							
6 1NO+1NC 13 21 14 22							
7 1NO+1NC 13 21 14 22							
9 2NC 11 21 12 22							
10 2NO 13 23 14 24							
11 2NC 11 21 12 22							
12 2NO 13 23 14 24							
13 2NC 11 21 12 22							
14 2NC 11 21 12 22							
15 2NO 13 23 14 24							
16 2NC 11 21 12 22							
18 1NO+1NC 13 21 14 22							
20 1NO+2NC 11 21 33 12 22 34							
21 3NC 11 21 31 12 22 32							
22 2NO+1NC 11 23 33 12 24 34							
33 1NO+1NC 13 21 14 22							
34 2NC 11 21 12 22							

All measures in the drawings are in mm or degrees

Travel diagrams table: position switches for normal application with reset W3, FR - FX series

Contact block	Group 1c	Group 2c	Group 3c	Group 4c
6 1NO+1NC				
9 2NC				
10 2NO				
20 1NO+2NC				
21 3NC				
22 2NO+1NC				
33 1NO+1NC				
34 2NC				

Maximum and minimum actuation speed: prewired switches FA-FB-FF series

Type 1

Lever with roller

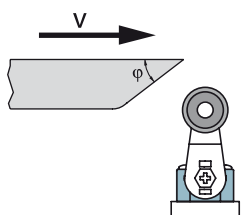

φ	Vmax (m/s)	Vmin (mm/s) L	Vmin (mm/s) R
15°	2,5	9	0,07
30°	1,5	8	
45°	1	7	
60°	0,75	7	

Type 2

Plunger with roller

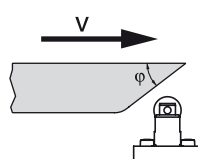

φ	Vmax (m/s)	Vmin (mm/s) L	Vmin (mm/s) R
15°	0,2	4	0,04
30°	0,1	2	0,02
45°	0,06	1	0,01

Type 3

Lever with roller

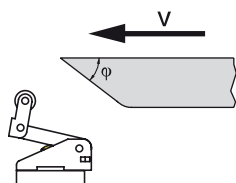

φ	Vmax (m/s)	Vmin (mm/s) L	Vmin (mm/s) R
15°	1	5	0,05
30°	0,5	2,5	0,025
45°	0,3	1,5	0,015

Type 4

Plunger

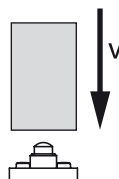

Vmax (m/s)	Vmin (mm/s) L	Vmin (mm/s) R
0,5	1	0,01

Contacts type:

- R** = snap action
- L** = slow action

All measures in the drawings are in mm or degrees

**Screw driving torques: prewired switches FA-FB-FF series**

**For FF series only:**

Head screws **2**  
 Lever screws **3**  
 M4 screws for the housing fastening **6**.

**0,4 ... 0,6 Nm**  
**0,7 ... 0,9 Nm**  
**2... 3 Nm**

**For FA and FB series only:**

Head screws **2**  
 Lever screws **3**  
 M4 screws for the housing fastening **6**.

**0,8 ... 1,2 Nm**  
**0,8 ... 1,2 Nm**  
**2... 3 Nm**



**Travel diagrams table: prewired switches FA - FB - FF series**

**Snap action**

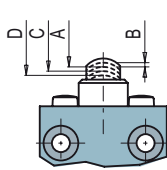
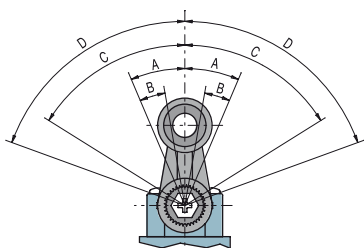

Pushing the switch

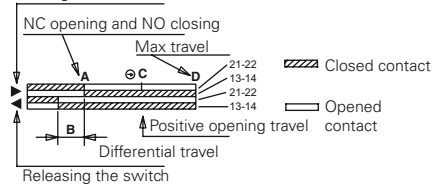

**Slow action**

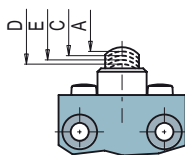
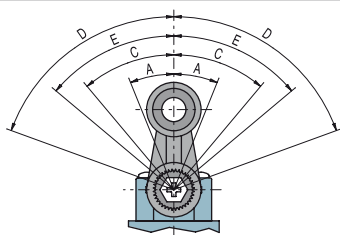

NC opening

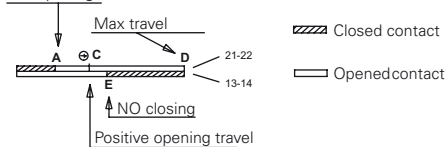

Contact block

Group 1

Group 2

Group 3

Group 4

41 1NO+1NC				
45 1NO+1NC				
46 1NO+1NC				
48 1NO+1NC				

## Features

The contact blocks developed by the company Pizzato Elettrica contain the experience gained in 30 years of technological development and in millions of pieces sold. The contact blocks range available shown in this chapter is one of the widest in the world in the sector of position switches.

This chapter introduces to some features of Pizzato Elettrica contact blocks, in order to give the final user a better understanding of the technologies behind that element simply named "contact".

We underline that contact blocks are not available for sale (to the public) separately from switches, both because some of them are mechanically connected to the switch and because some technical features may change in accordance with the switch and its function. The following data intend to be a selection of all contact blocks, but cannot be used to determine complete characteristics of the switch equipped with that contact block.

For example, when a contact block with positive opening is used in a switch with a not rigid actuator, the result is a switch that on the whole is not one with positive opening.

The complete list of contact blocks currently in production is visible on page 6/11, and contacts operation points in accordance with the switches family and actuator type are visible on pages 6/13, 6/14 and 6/15.

On page 6/19, the features of the electronic contact block E1, which can be used on position switches for a series of surveys, otherwise complex even with electronic sensors, are explained in detail. On the market doesn't exist an electronic sensor that at the same time has the characteristics of operation precision and repeatability, ability of the switching point adjustment, working temperature and price of this unit.

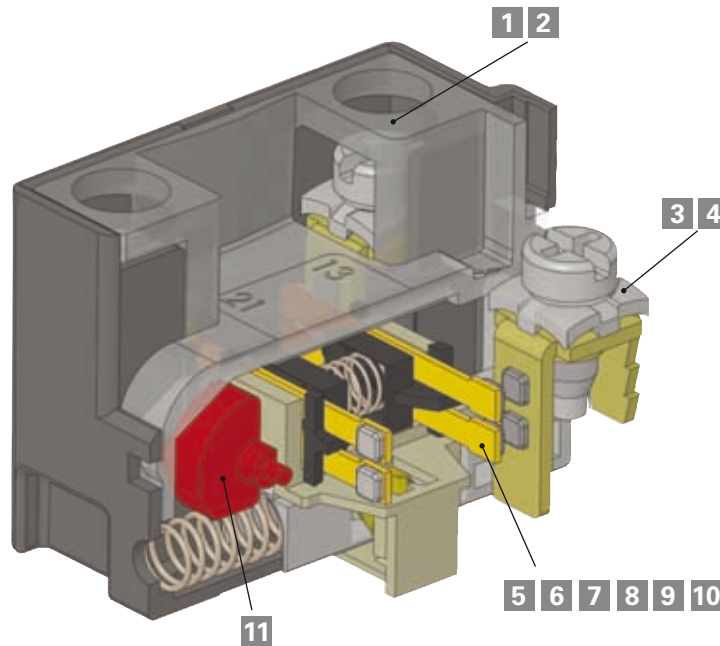

Description	Page	Description	Page
<b>1</b> Retained screws	6/6	<b>8</b> Classification of the contact blocks according to the standard IEC 947-5-1: X, Y, C, Za, Zb	6/9
<b>2</b> Finger protection terminals	6/6	<b>9</b> Contact type: Slow action / snap action / snap action with steady pressure	6/10
<b>3</b> Clamping screw plates for different diameter cables	6/6	<b>10</b> Force on the contacts	6/10
<b>4</b> Self-lifting clamping screw plates	6/6	<b>11</b> Positive opening of the contacts	6/29
<b>5</b> Contact material: Silver alloy or gold-plated silver alloy	6/6		
<b>6</b> Contact block technology and reliability: Single bridge, double bridge	6/7		
<b>7</b> Operation voltage and current for reliable switching	6/8		

### 1 Retained screws

Switches with this characteristic have clamping screws that remain in seat even if completely unscrewed. This feature reduces wiring time, since the operator does not have to be careful not to unscrew the screws completely and does not risk to lose them by mistake, which is very useful in case of wirings in uncomfortable position.

### 2 Finger protection terminals

All terminals in the contact blocks have a protection degree IP20, in accordance with the standard IEC 529, therefore they are protected against access to dangerous parts with diameter over 12 mm.



### 3 Clamping screw plates for different diameter cables

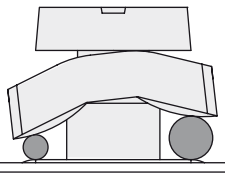

These clamping screw plates have a particular "roofing tile" structure and are connected loosely to the clamping screw. In this way, during the wires fixing, the clamping screw plate is able to suit to cables of different diameter (see picture) and tends to tighten the wires toward the screw instead of permitting them to escape towards the outside.

### 4 Self-lifting clamping screw plates

Switches with this feature have clamping screw plates that go up or down turning the clamping screw, permitting an easy and quick wiring.

### 5 Contact material: gold-plated silver alloy

The contact blocks can be supplied with silver electric contacts with a special gold-plated surface, with total gold thickness of one micron. This type of treatment can be useful in environments which are aggressive against silver (very humid or sulphurous atmospheres) and in case of very small electric charges, usually with low voltages and supply currents. The gold thickness used has been studied for resistance to millions of mechanical cycles.

## 6 Contact block technology and reliability

Sometimes, hardly ever, an electric contact may not work. A commutation failure is a typical consequence of an occasional presence of a high resistance on the contacts due to dust, a slight layer of oxidation, or impurity of any kind that remains inside the switch during its wiring. The repeatability of this type of phenomena depends not only on the switch, but also on the environmental working conditions and the type of load the switch drives. These effects are more evident with low electrical loads, when the electric voltage does not succeed in perforating thin layers of oxide or small dust grains.

This type of malfunction may be accepted in the hand-operated devices, because it is enough to repeat the operation in order to make everything work again. This is not the case with position switches, where a failure in a switch could cause considerable damage to the machinery.

In the following table we refer to two typical contact structures (type A and B) normally used in the industry and the ones which have been used by Pizzato Elettrica for several years in most of the switches: movable contacts with double interruption and twin bridge (type C).

As you can see from the table below, this last structure (type C) features the same contact resistance ( $R$ ) of the simple mobile contact (type A), but with a much lower probability of failure ( $f_e$ ).

In fact, defined  $x$  the probability of a single interruption failure, it results that in the contact type A the commutation failure probability  $f_e = x$ , in the type B  $f_e \cong 2 \cdot x$ , whereas in the type C it is  $f_e \cong 4 \cdot x^2$ .

This means that if in a certain situation the probability of a single interruption failure  $x$  is equal, for instance, to  $1 \times 10^{-4}$  (1 failed interruption every 10.000) we will have:

- In type A one failed commutation every 10.000
- In type B one failed commutation every 5.000
- In type C one failed commutation every 25.000.000

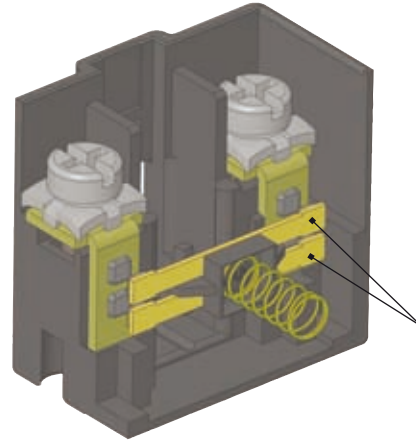

Type	Figure	Description	Contact resistance $R$	Probability of failure $f_e$
A		simple contact	$R = R_c$	$f_e = x$
B		contacts with double interruption	$R = 2 \cdot R_c$	$f_e = 2x - x^2$
C		contacts with double interruption and twin bridge	$R = \frac{2 \cdot R_c}{2} = R_c$	$f_e = 4x^2 - 4x^3 + x^4$

## 7 Operation voltage and current for reliable switching

The electric contact reliability depends on a lot of elements that change their effect in accordance with the load type. For high power loads it is essential that the contact should be able to eliminate the heat created during switching. For low power loads, instead, it is important that oxides or other impurities do not obstruct the passing of the electric signal. The choice of the electric contacts material is a compromise between different and sometimes opposing requirements. For position switches contacts it is usually used a silver alloy that has resulted suitable for switching of loads in the range between about 1 KW and 0,1 W. Moving below this power range, it is possible to have some effects because of the oxide naturally created by silver on contact with the air; just as possible contaminations or impurities in the contact switching chamber, for example the talc powder in wires sheathes that an installer could accidentally insert in the switch, become very important.

It is not possible to define a fix threshold beyond which the "missing switching phenomenon" does not appear, because there are a lot of mechanical and electric parameters that influence this value. For example, a good twin bridge electric contact in laboratory is able to switch without signal losing loads of about microW for dozens of millions of handling operations. However, this does not mean that the same contact is able to provide the same services when the switch operates in an area with sudden changes of temperature (condensate formation) or with few switchings (oxides formation).

To avoid part of this type of problems, for very low loads are used gold plated contacts, profiting from the non-oxidability of this material. The thickness of the gold-plating should be adequate to be mechanically resistant to switching and to be electrically resistant to possible sparks that may vaporize it. It is for this reason that Pizzato Elettrica uses micron thickness gold plating suitable for millions of working cycles. Gold platings with lower thickness have simply an aesthetic function, suitable only for protection of the product against oxidation when kept in stock for long time.

The minimum current and voltage values suggested by Pizzato Elettrica are readable on the diagram below, divided in two areas defined by a steady power limit. These values identify voltage and current combinations with high commutation reliability in most industrial fields. The lower voltage and current limits shown in the diagram are typical minimum values in industrial application that may also be reduced in not general conditions. It is recommended, however, to always evaluate that the power signal to commutate should be at least one magnitude order higher than the noise produced in the electric circuit, in particular when circuit cables are long and pass through areas with high electromagnetic fields, especially with signal powers lower than 10 mW.

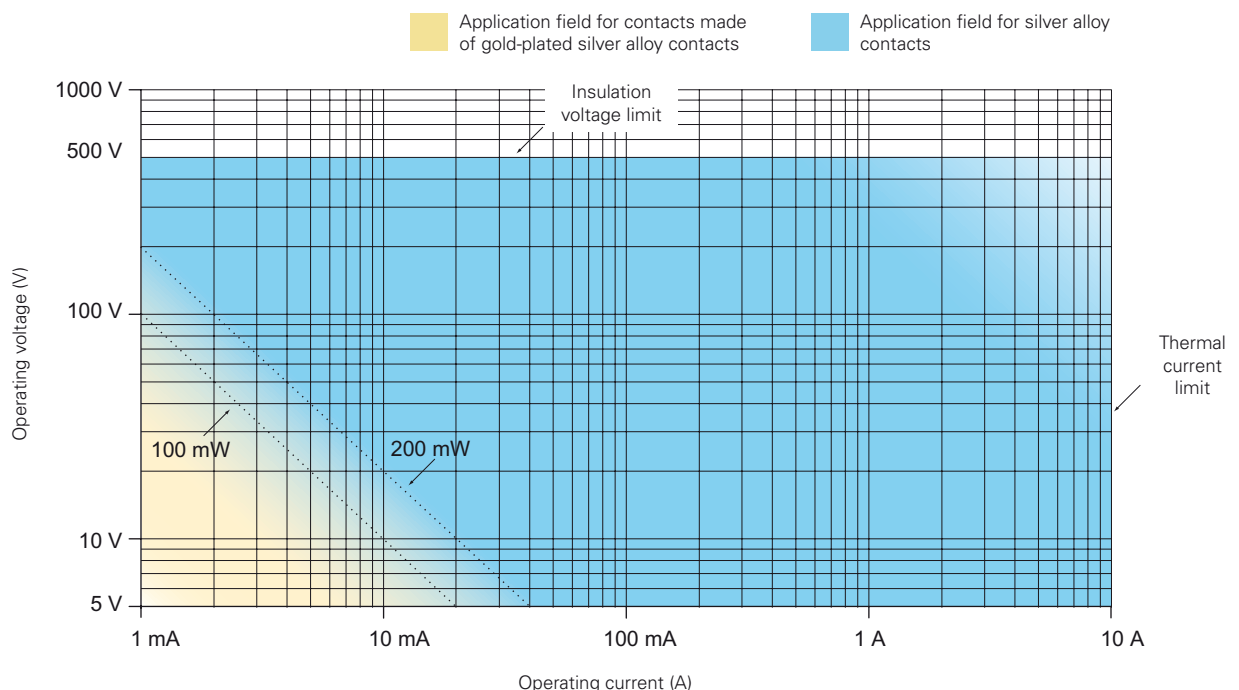

**100 mW** Suggested limit for general applications with snap action contact blocks with silver alloy contacts.

**200 mW** Suggested limit for general applications with slow action contact blocks with silver alloy contacts.



## 8 Classification of the contact blocks according to the standard IEC 947-5-1

Form	Figure	Symbol	Description
X			Contact component having double gap with two terminals.
Y			
C			Change-over contact component having simple gap with three terminals.
Za			Shifting contact component having double gap with four terminals. <b>Contacts have the same polarity</b>
Zb			Shifting contact component having double gap with four terminals. <b>Moving contacts are electrically separated</b>

**Electrically separated contacts**

Symbol "+" between contact forms (e.g. X+X, Za+Za, X+X+Y, etc.) indicates the combinations of simple contact blocks **electrically separated** between each other.

The **electrically separated contacts allow** the application of different voltages on the contacts and the connection of loads on different polarities (figure 1).

**Prescriptions and restrictions for Za contacts**

Electrical loads must be connected to the same phase or polarity. The contacts **are not** electrically separated, connection of different voltages between the NC contact and the NO contact is not allowed. Also, as prescribed by the standard IEC 947-5-1 paragraph K.7.1.4.6.1, if Za contacts with positive opening for safety applications are used, the following restrictions have to be adopted:

" If the control accessory has shifting contacts components with form C or Za, **you have to use only one contact component** (closure or cutoff). In case of shifting contact with form Zb, both contacts may be used..."

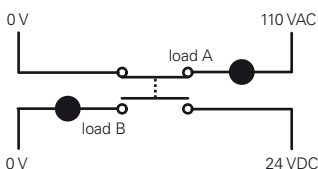
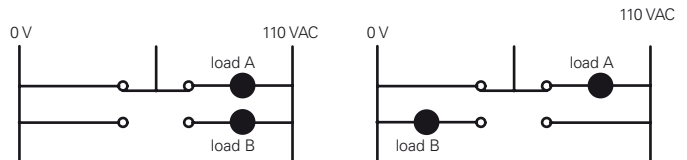
**Zb form contact**figure 1: **correct****Za form contact**figure 2: **correct**figure 3: **incorrect**

**9 Contact block with dependent action: slow action and snap action**

**Contact blocks with slow action:** component where the speed of the contact movement (**V1**) depends on the speed of the switch actuation (**V**). The contact armature advances at a rate proportional to the actuation speed. The slow action contact block is suitable for applications having low to medium currents and quick actuation movements. It has no differential travel.

$$V = V1$$

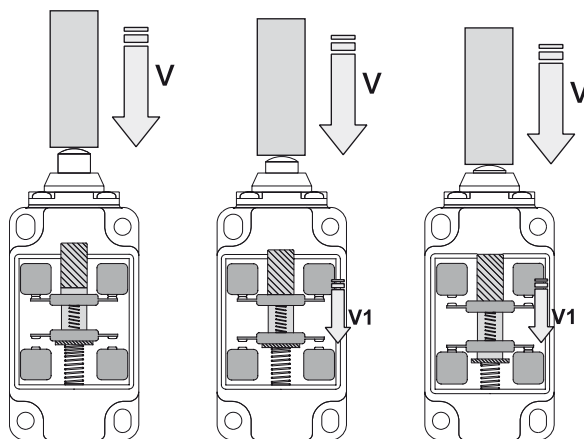

**Contact block with snap action:** component where the speed of the contact movement (**V1**) doesn't depend on the speed of the switch actuation (**V**). After reaching a predetermined point in travel, the contact armature snaps causing the contacts switching. The snap action contact block is suitable for applications having high currents and/or slow actuation movements. This kind of contact block has a differential travel.

$$V \neq V1$$

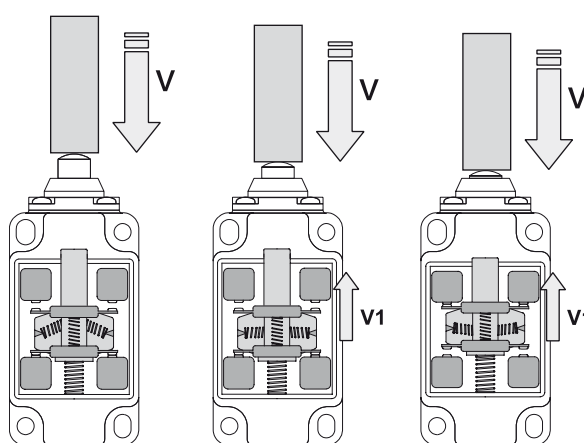

**10 Contact block: diagrams of the force on the contacts**

The following diagrams shows the relationship between of the force exerted on the contacts (**F**) compared to the switch armature travel.

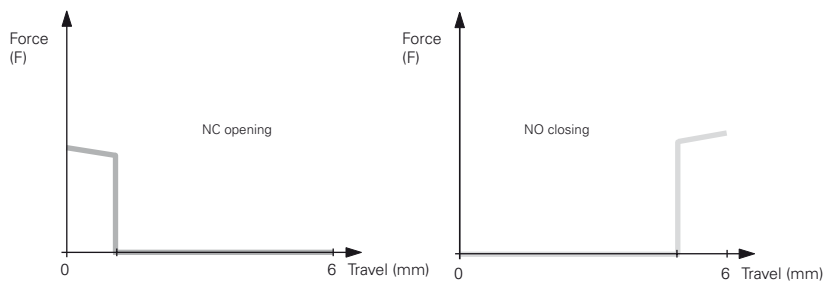

**Contact blocks with slow action**

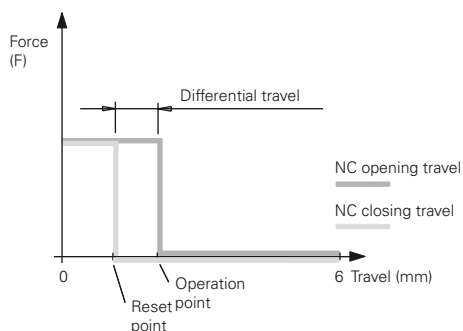

**Contact blocks with snap action 5, 11, 12.**  
The pressure on the contact remains constant while approaching to the snap point.

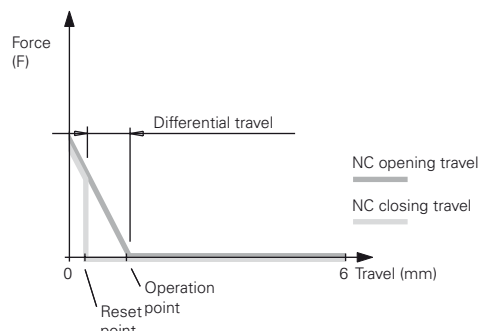

**Contact blocks with snap action 2, 3.**  
The pressure on the contact decreases while approaching to the snap point.

Contact block	Contact diagram	Linear travel diagram	Contact form	Contact type	Positive opening $\ominus$	Contact technology	Retained screws	Finger protection terminals
2	2x(1NO-1NC)		Za+Za	snap action	no	Double gap	no	no
3	1NO-1NC		Za	snap action	no	Double gap	no	no
5	1NO+1NC		Zb	snap action	yes	Double gap and double bridge	yes	yes
6	1NO+1NC		Zb	slow action	yes	Double gap and double bridge	yes	yes
7	1NO+1NC		Zb	slow action	yes	Double gap and double bridge	yes	yes
8	1NC		Y	slow action	yes	Double gap and double bridge	yes	yes
9	2NC		Y+Y	slow action	yes	Double gap and double bridge	yes	yes
10	2NO		X+X	slow action	no	Double gap and double bridge	yes	yes
11	2NC		Y+Y	snap action	yes	Double gap and double bridge	yes	yes
12	2NO		X+X	snap action	no	Double gap and double bridge	yes	yes
13	2NC		Y+Y	slow action	yes	Double gap and double bridge	yes	yes
14	2NC		Y+Y	slow action	yes	Double gap and double bridge	yes	yes
15	2NO		X+X	slow action	no	Double gap and double bridge	yes	yes
16	2NC		Y+Y	slow action	yes	Double gap and double bridge	yes	yes
18	1NO+1NC		Zb	slow action	yes	Double gap and double bridge	yes	yes
20	1NO+2NC		Y+Y+X	slow action	yes	Double gap and double bridge	yes	yes
21	3NC		Y+Y+Y	slow action	yes	Double gap and double bridge	yes	yes
22	2NO+1NC		Y+X+X	slow action	yes	Double gap and double bridge	yes	yes
28	1NO+2NC		Y+Y+X	slow action	yes	Double gap and double bridge	yes	yes
29	3NC		Y+Y+Y	slow action	yes	Double gap and double bridge	yes	yes
30	2NO+1NC		Y+X+X	slow action	yes	Double gap and double bridge	yes	yes
33	1NO+1NC		Zb	slow action	yes	Double gap and double bridge	yes	yes
34	2NC		Y+Y	slow action	yes	Double gap and double bridge	yes	yes
41	1NO+1NC		Zb	snap action	no	Double gap	/	/
45	1NO+1NC		Zb	snap action	yes	Double gap	/	/
46	1NO+1NC		Zb	slow action	yes	Double gap	/	/
48	1NO+1NC		Zb	slow action	yes	Double gap	/	/
60•	Contact block with 4 poles, with multiple forms of contact. See page 4/16			slow action	yes	Double gap, simple bridge and double bearing	yes	yes
E1	1NO-1NC		PNP	electronic	no	electronic	no	no

Contact block	Gold-plated contacts	Cross section of the conductors	Rated insulation voltage U <sub>i</sub>	Thermal current I <sub>th</sub>	Utilization categories	
					AC 15	DC 13
2	Not available	min. 1 x 0,5 mm <sup>2</sup> (1 x AWG 20) max. 2 x 1,5 mm <sup>2</sup> (2 x AWG 16)	500 VAC 600 VDC	10 A	Ue (V) 250 400 500 Ie (A) 6 4 1	Ue (V) 24 125 250 Ie (A) 6 1,1 0,4
3	Not available	min. 1 x 0,5 mm <sup>2</sup> (1 x AWG 20) max. 2 x 1,5 mm <sup>2</sup> (2 x AWG 16)	500 VAC 600 VDC	10 A	Ue (V) 250 400 500 Ie (A) 6 4 1	Ue (V) 24 125 250 Ie (A) 6 1,1 0,4
5	Available	min. 1 x 0,5 mm <sup>2</sup> (1 x AWG 20) max. 2 x 2,5 mm <sup>2</sup> (2 x AWG 14)	500 VAC 600 VDC	10 A	Ue (V) 250 400 500 Ie (A) 6 4 1	Ue (V) 24 125 250 Ie (A) 6 1,1 0,4
6	Available	min. 1 x 0,5 mm <sup>2</sup> (1 x AWG 20) max. 2 x 2,5 mm <sup>2</sup> (2 x AWG 14)	500 VAC 600 VDC	10 A	Ue (V) 250 400 500 Ie (A) 6 4 1	Ue (V) 24 125 250 Ie (A) 6 1,1 0,4
7	Available	min. 1 x 0,5 mm <sup>2</sup> (1 x AWG 20) max. 2 x 2,5 mm <sup>2</sup> (2 x AWG 14)	500 VAC 600 VDC	10 A	Ue (V) 250 400 500 Ie (A) 6 4 1	Ue (V) 24 125 250 Ie (A) 6 1,1 0,4
8	Available	min. 1 x 0,5 mm <sup>2</sup> (1 x AWG 20) max. 2 x 2,5 mm <sup>2</sup> (2 x AWG 14)	500 VAC 600 VDC	10 A	Ue (V) 250 400 500 Ie (A) 6 4 1	Ue (V) 24 125 250 Ie (A) 6 1,1 0,4
9	Available	min. 1 x 0,5 mm <sup>2</sup> (1 x AWG 20) max. 2 x 2,5 mm <sup>2</sup> (2 x AWG 14)	500 VAC 600 VDC	10 A	Ue (V) 250 400 500 Ie (A) 6 4 1	Ue (V) 24 125 250 Ie (A) 6 1,1 0,4
10	Available	min. 1 x 0,5 mm <sup>2</sup> (1 x AWG 20) max. 2 x 2,5 mm <sup>2</sup> (2 x AWG 14)	500 VAC 600 VDC	10 A	Ue (V) 250 400 500 Ie (A) 6 4 1	Ue (V) 24 125 250 Ie (A) 6 1,1 0,4
11	Available	min. 1 x 0,5 mm <sup>2</sup> (1 x AWG 20) max. 2 x 2,5 mm <sup>2</sup> (2 x AWG 14)	500 VAC 600 VDC	10 A	Ue (V) 250 400 500 Ie (A) 6 4 1	Ue (V) 24 125 250 Ie (A) 6 1,1 0,4
12	Available	min. 1 x 0,5 mm <sup>2</sup> (1 x AWG 20) max. 2 x 2,5 mm <sup>2</sup> (2 x AWG 14)	500 VAC 600 VDC	10 A	Ue (V) 250 400 500 Ie (A) 6 4 1	Ue (V) 24 125 250 Ie (A) 6 1,1 0,4
13	Available	min. 1 x 0,5 mm <sup>2</sup> (1 x AWG 20) max. 2 x 2,5 mm <sup>2</sup> (2 x AWG 14)	500 VAC 600 VDC	10 A	Ue (V) 250 400 500 Ie (A) 6 4 1	Ue (V) 24 125 250 Ie (A) 6 1,1 0,4
14	Available	min. 1 x 0,5 mm <sup>2</sup> (1 x AWG 20) max. 2 x 2,5 mm <sup>2</sup> (2 x AWG 14)	500 VAC 600 VDC	10 A	Ue (V) 250 400 500 Ie (A) 6 4 1	Ue (V) 24 125 250 Ie (A) 6 1,1 0,4
15	Available	min. 1 x 0,5 mm <sup>2</sup> (1 x AWG 20) max. 2 x 2,5 mm <sup>2</sup> (2 x AWG 14)	500 VAC 600 VDC	10 A	Ue (V) 250 400 500 Ie (A) 6 4 1	Ue (V) 24 125 250 Ie (A) 6 1,1 0,4
16	Available	min. 1 x 0,5 mm <sup>2</sup> (1 x AWG 20) max. 2 x 2,5 mm <sup>2</sup> (2 x AWG 14)	500 VAC 600 VDC	10 A	Ue (V) 250 400 500 Ie (A) 6 4 1	Ue (V) 24 125 250 Ie (A) 6 1,1 0,4
18	Available	min. 1 x 0,5 mm <sup>2</sup> (1 x AWG 20) max. 2 x 2,5 mm <sup>2</sup> (2 x AWG 14)	500 VAC 600 VDC	10 A	Ue (V) 250 400 500 Ie (A) 6 4 1	Ue (V) 24 125 250 Ie (A) 6 1,1 0,4
20	Available	min. 1 x 0,34 mm <sup>2</sup> (1 x AWG 22) max. 2 x 1,5 mm <sup>2</sup> (2 x AWG 16)	400 VAC 600 VDC	10 A	Ue (V) 250 400 Ie (A) 6 4	Ue (V) 24 125 250 Ie (A) 6 1,1 0,4
21	Available	min. 1 x 0,34 mm <sup>2</sup> (1 x AWG 22) max. 2 x 1,5 mm <sup>2</sup> (2 x AWG 16)	400 VAC 600 VDC	10 A	Ue (V) 250 400 Ie (A) 6 4	Ue (V) 24 125 250 Ie (A) 6 1,1 0,4
22	Available	min. 1 x 0,34 mm <sup>2</sup> (1 x AWG 22) max. 2 x 1,5 mm <sup>2</sup> (2 x AWG 16)	400 VAC 600 VDC	10 A	Ue (V) 250 400 Ie (A) 6 4	Ue (V) 24 125 250 Ie (A) 6 1,1 0,4
28	Available	min. 1 x 0,34 mm <sup>2</sup> (1 x AWG 22) max. 2 x 1,5 mm <sup>2</sup> (2 x AWG 16)	400 VAC 600 VDC	10 A	Ue (V) 250 400 Ie (A) 6 4	Ue (V) 24 125 250 Ie (A) 6 1,1 0,4
29	Available	min. 1 x 0,34 mm <sup>2</sup> (1 x AWG 22) max. 2 x 1,5 mm <sup>2</sup> (2 x AWG 16)	400 VAC 600 VDC	10 A	Ue (V) 250 400 Ie (A) 6 4	Ue (V) 24 125 250 Ie (A) 6 1,1 0,4
30	Available	min. 1 x 0,34 mm <sup>2</sup> (1 x AWG 22) max. 2 x 1,5 mm <sup>2</sup> (2 x AWG 16)	400 VAC 600 VDC	10 A	Ue (V) 250 400 Ie (A) 6 4	Ue (V) 24 125 250 Ie (A) 6 1,1 0,4
33	Available	min. 1 x 0,34 mm <sup>2</sup> (1 x AWG 22) max. 2 x 1,5 mm <sup>2</sup> (2 x AWG 16)	400 VAC 600 VDC	10 A	Ue (V) 250 400 Ie (A) 6 4	Ue (V) 24 125 250 Ie (A) 6 1,1 0,4
34	Available	min. 1 x 0,34 mm <sup>2</sup> (1 x AWG 22) max. 2 x 1,5 mm <sup>2</sup> (2 x AWG 16)	400 VAC 600 VDC	10 A	Ue (V) 250 400 Ie (A) 6 4	Ue (V) 24 125 250 Ie (A) 6 1,1 0,4
41	Available	/	500 VAC 600 VDC	10 A	Ue (V) 120 250 400 Ie (A) 6 4 1	Ue (V) 24 125 250 Ie (A) 2,5 0,55 0,27
45	Available	/	500 VAC 600 VDC	10 A	Ue (V) 120 250 400 Ie (A) 6 4 1	Ue (V) 24 125 250 Ie (A) 2,5 0,55 0,27
46	Available	/	500 VAC 600 VDC	10 A	Ue (V) 120 250 400 Ie (A) 6 4 1	Ue (V) 24 125 250 Ie (A) 2,5 0,55 0,27
48	Available	/	500 VAC 600 VDC	10 A	Ue (V) 120 250 400 Ie (A) 6 4 1	Ue (V) 24 125 250 Ie (A) 2,5 0,55 0,27
60•	Available	min. 1 x 0,34 mm <sup>2</sup> (1 x AWG 22) max. 2 x 1,5 mm <sup>2</sup> (2 x AWG 16)	250 VAC 300 VDC	10 A	Ue (V) 250 Ie (A) 5	Ue (V) 24 125 Ie (A) 6 1,1
E1	/	min. 1 x 0,5 mm <sup>2</sup> (1 x AWG 20) max. 2 x 2,5 mm <sup>2</sup> (1 x AWG 14)		/	/	Ue (V) 10 ... 30 Ie (A) 0,2

## X-ON Electronics

Largest Supplier of Electrical and Electronic Components

*Click to view similar products for [Limit Switches](#) category:*

*Click to view products by [Pizzato](#) manufacturer:*

Other Similar products are found below :

[6LS2-4PG](#) [5ML1-E1](#) [5ML31](#) [LZG1](#) [LZL1-6C](#) [622EN114-R](#) [622EN18-6](#) [622EN224-6B](#) [622EN230](#) [622EN237-R](#) [622EN69-3](#) [622EN85-RB](#)  
[MA-10019](#) [6PA109](#) [7LS51](#) [83547001](#) [83725002](#) [83830001](#) [83840001](#) [83840701](#) [83841001](#) [83870104](#) [83881140](#) [8AS42](#) [8LS10](#) [8LS125-](#)  
[4PG](#) [8LS152-4PGN20](#) [914CE16-3A](#) [914CE3-3L1](#) [915PA10](#) [91MCE16-P2O](#) [924CE16-Y3](#) [924CE1-S6](#) [924CE1-T25A](#) [924CE1-T3](#) [924CE1-](#)  
[T9A](#) [924CE2-T9](#) [924CE31-Y20-X5](#) [924CE31-Y3L1](#) [GL-10054](#) [GL-85710](#) [GL-85714](#) [GLAB26J2B](#) [GLDB03C-6](#) [GLZ324](#) [PS21R-](#)  
[NT11N7-YK0](#) [D4A-1106N](#) [D4A1201N](#) [D4A-3E02N](#) [D4A-4510N](#)