

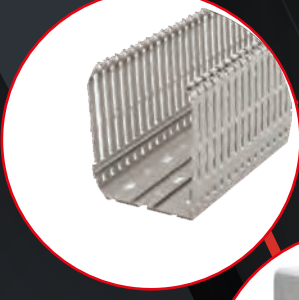

The Art of Electricity

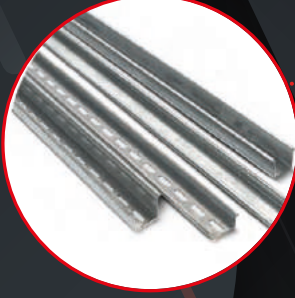

2019 PRODUCT CATALOGUE



PLASTIM ELEKTRİK was established in 2008 and today is among the leading manufacturers of ABS Electrical Panels, Electrical Panel Climatisation Products, Slotted Cable Ducts, Heaters etc. in Turkey. PLASTIM currently exports to more than 50 countries worldwide.

Its product range has also been constantly widened to suit the various requirements of its customers. It has a primary goal of providing customers with the best service in satisfying their industrial needs. To fulfil this purpose, the company always pushes to enhance its and research development (R&G) activities so that new products of high-quality can be added to its portfolio.





From Turkey to **worldwide**



www.plastim.com.tr

Contents

Cable Management.....	05-08
Electrical Distribution.....	09-13
Ventilation.....	14-25
Control.....	26-30
Air Conditioning.....	31-32
Heating.....	33-37
Panel Accessories.....	38
Distribution Blocks.....	39
Copper Tubular Cable Lugs.....	40
Din Rails and Support.....	41
Pet Expandable Braided Sleeving.....	42
Cable Terminals.....	43-48
PB0 Push Button Series.....	49-53

CABLE MANAGEMENT

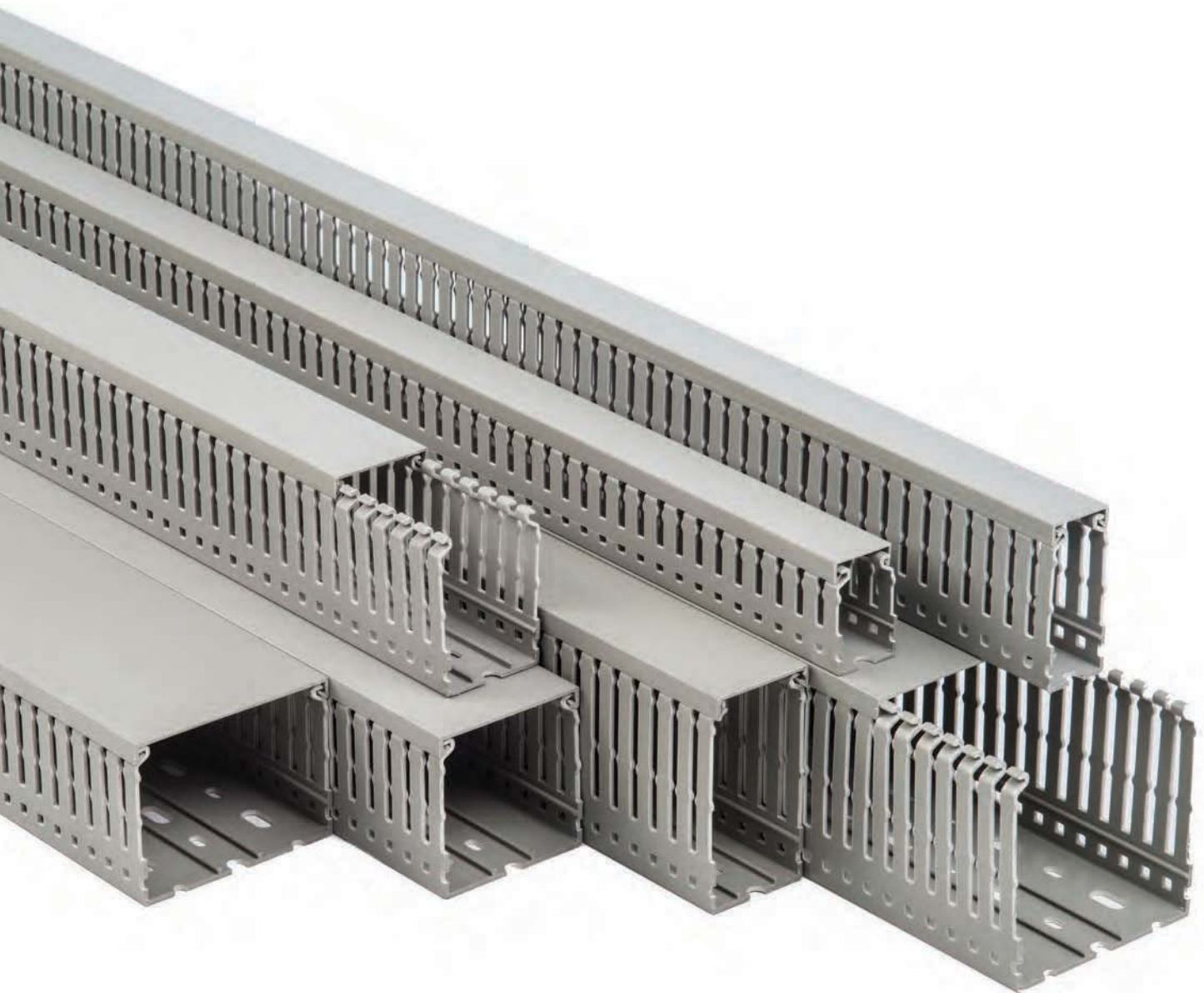



Upper Scorelines

The pre-scored upper lines at the base of the ducts provide easy breaking off the ribs as a result of 90 degree bending without using any hand tool.

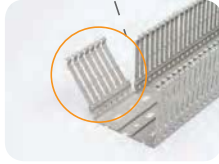
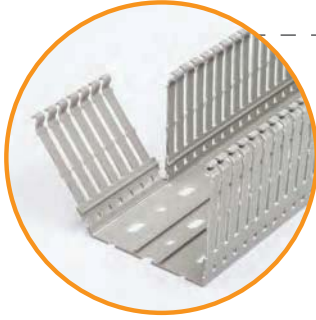

Lower Scorelines

Lower scorelines at the base enable to remove the whole trunking wall.

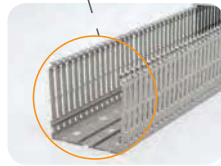
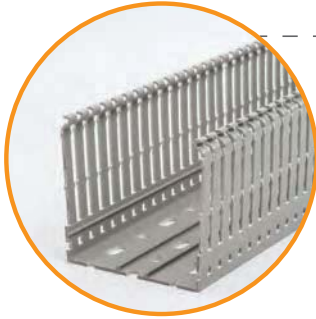

Bottom Rails

You can easily mount the accessories on the bottom rails of the duct.



Special Cover Design

The cover design lets you easily assemble and disassemble the cover regardless in whatever position the duct is installed.

PLASTİM PDK6060 RoHS CE EN50085 2-3 MADE IN TURKEY



SLOTTED TYPE WIRING DUCTS

MAIN TECHNICAL FEATURES:

- Made of: technopolymer on rigid PVC base, self-extinguishing (UL94) V0
- Narrow slots 4/6/4mm + 5/8/5mm
- Perforated bottom according to the standart DIN 43659
- Standart bars length: 2m
- Reference Standarts: EN 5085-2-3
- Packed in strong cardboard boxes suitable for transport and storage
- Standart colour RAL7030, other colours on request
- **CE** RoHS



SLOTTED WIRING DUCTS

Code	External Dimensions (mm)	Slot Range (mm)	Colour	Packaging
PDK 2540	25x40	4/6/4 mm	RAL 7030 Grey	64x2m
PDK 2560	25x60	4/6/4 mm	RAL 7030 Grey	48x2m
PDK 2580	25x80	4/6/4 mm	RAL 7030 Grey	32x2m
PDK 4040	40x40	4/6/4 mm	RAL 7030 Grey	35x2m
PDK 4060	40x60	4/6/4 mm	RAL 7030 Grey	30x2m
PDK 4080	40x80	4/6/4 mm	RAL 7030 Grey	20x2m
PDK 4010	40x100	5/8/5 mm	RAL 7030 Grey	20x2m
PDK 6040	60x40	4/6/4 mm	RAL 7030 Grey	25x2m
PDK 6060	60x60	4/6/4 mm	RAL 7030 Grey	24x2m
PDK 6080	60x80	4/6/4 mm	RAL 7030 Grey	16x2m
PDK 6010	60x100	5/8/5 mm	RAL 7030 Grey	16x2m
PDK 8060	80x60	4/6/4 mm	RAL 7030 Grey	14x2m
PDK 8080	80x80	4/6/4 mm	RAL 7030 Grey	12x2m
PDK 8010	80x100	5/8/5 mm	RAL 7030 Grey	12x2m
PDK 1060	100x60	4/6/4 mm	RAL 7030 Grey	10x2m
PDK 1080	100x80	4/6/4 mm	RAL 7030 Grey	10x2m
PDK 1010	100x100	5/8/5 mm	RAL 7030 Grey	8x2m
PDK 1260	120x60	4/6/4 mm	RAL 7030 Grey	10x2m
PDK 1280	120x80	4/6/4 mm	RAL 7030 Grey	8x2m

WIRING DUCT ACCESSORIES

WIRING DUCT COVERS

CODE	DIMENSIONS (mm)	COLOUR	PACKAGING
PDC 25	25	RAL 7030 Grey	50 Pcs
PDC 40	40	RAL 7030 Grey	50 Pcs
PDC 60	60	RAL 7030 Grey	50 Pcs
PDC 80	80	RAL 7030 Grey	50 Pcs
PDC 100	100	RAL 7030 Grey	50 Pcs
PDC 120	120	RAL 7030 Grey	50 Pcs



WIRING DUCT CABLE RETAINERS

CODE	DIMENSIONS (mm)	COLOUR	PACKAGING
PKT 4040	40X40	RAL 7030 Grey	10 Pcs
PKT 4060	40x60	RAL 7030 Grey	10 Pcs
PKT 6060	60x60	RAL 7030 Grey	10 Pcs

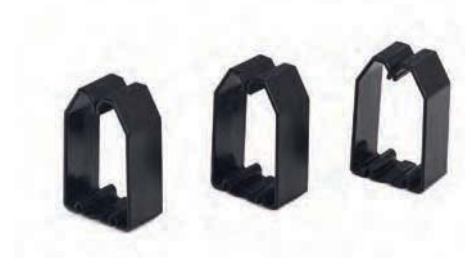

WIRING DUCT CUTTING TOOL

CODE	MAX. CUTTING SIZE	PACKAGING
PDC 110	110mm	1 Pc



ELECTRICAL DISTRIBUTION



PLASTIC DISTRIBUTION BOARDS GREY DOOR



MAIN TECHNICAL FEATURES

- Resistance: Chemical agents, alkali, oils, salts, etc.
- Rated Voltage: Up to 690V
- Maximum Current: Up to 800A
- Operating Temperature: -35°C + 65°C
- Material: HB ABS
- Mounting Plate: Galvanised steel 1mm
- IP Degree: IP65
- IK Degree: IK08
- Colour: RAL7035 Grey (Other colours on request)
- **CE** RoHS



Polyurethane
Sealing



PLASTIC DISTRIBUTION BOARDS - GREY DOOR

CODE	L (mm)	W (mm)	H (mm)	WEIGHT(kg)
PP3001	200	300	130	1.70
PP3002	250	350	150	2.20
PP3004	300	400	170	3.00
PP3005	300	400	220	3.40
PP3006	350	500	190	4.30
PP3003	400	500	175	4.30
PP3007	400	500	240	5.60
PP3008	400	600	200	6.00
PP3010	500	700	250	10.10
PP3021	600	800	260	13.50

PLASTIC DISTRIBUTION BOARDS **TRANSPARENT DOOR**



MAIN TECHNICAL FEATURES

- Resistance: Chemical agents, alkali, oils, salts, etc.
- Rated Voltage: Up to 690V
- Maximum Current: Up to 800A
- Operating Temperature: -35°C + 65°C
- Material: HB ABS + Polycarbonate (Doors)
- Mounting Plate: Galvanised steel 1mm
- IP Degree: IP65
- IK Degree: IK08
- Colour: RAL7035 Grey body, transparent door (Other colours on request)
- **CE** RoHS



Polyurethane
Sealing



PLASTIC DISTRIBUTION BOARDS - TRANSPARENT DOOR

CODE	L (mm)	W (mm)	H (mm)	WEIGHT(kg)
PP3011	200	300	130	1.70
PP3012	250	350	150	2.20
PP3014	300	400	170	3.00
PP3015	300	400	220	3.40
PP3016	350	500	190	4.30
PP3013	400	500	175	4.30
PP3017	400	500	240	5.60
PP3018	400	600	200	6.00
PP3020	500	700	250	10.10
PP3022	600	800	260	13.50

MODULAR DISTRIBUTION BOARDS GREY DOOR



MAIN TECHNICAL FEATURES

- Resistance: Chemical agents, alkali, oils, salts, etc.
- Rated Voltage: Up to 690V
- Maximum Current: Up to 800A
- Operating Temperature: -35°C + 65°C
- Material: HB ABS
- IP Degree: IP65
- IK Degree: IK08
- Colour: RAL7035 Grey (Other colours on request)
- **CE** RoHS



Polyurethane
Sealing



MODULAR DISTRIBUTION BOARDS - GREY DOOR

CODE	L (mm)	W (mm)	H (mm)	MCB Qty	WEIGHT(kg)
PP3102	250	350	150	18 (9x2)	2.50
PP3104	300	400	170	24 (12x2)	3.40
PP3106	350	500	190	45 (15x3)	4.50
PP3108	400	600	200	60 (15x4)	6.00

MODULAR DISTRIBUTION BOARDS TRANSPARENT DOOR



MAIN TECHNICAL FEATURES

- Resistance: Chemical agents, alkali, oils, salts, etc.
- Rated Voltage: Up to 690V
- Maximum Current: Up to 800A
- Operating Temperature: -35°C + 65°C
- Material: HB ABS + Polycarbonate (Doors)
- IP Degree: IP65
- IK Degree: IK08
- Colour: RAL7035 Grey body, transparent door (Other colours on request)
-  RoHS



Polyurethane
Sealing



MODULAR DISTRIBUTION BOARDS - TRANSPARENT DOOR

CODE	L (mm)	W (mm)	H (mm)	MCB Qty	WEIGHT(kg)
PP3112	250	350	150	18 (9x2)	2.50
PP3114	300	400	170	24 (12x2)	3.40
PP3116	350	500	190	45 (15x3)	4.50
PP3118	400	600	200	60 (15x4)	6.00



ROOF FANS



IP54



Polyurethane
Sealing



Radial
Fan

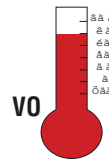

V0 Abs Flame
Retardant



Fast Clip
On

 **plastim**[®]

VENTILATION





ROOF FANS

MODELS	UNIT	PFF4000	PFF5500	PFF6000
AIR FLOW RATE	m ³ /h	400	560	970
POWER SUPPLY	V/Hz	230V 50-60Hz	230V 50-60Hz	230V 50-60Hz
DIMENSIONS	mm	364x364x107	364x364x107	364x364x107
POWER CONSUMPTION	W	25/32	58/75	85/90
CURRENT CONSUMPTION	A	0.11/0,15	0.26/0.34	0.38/0.44
OVERCURRENT PROTECTION	-	THERMAL	THERMAL	THERMAL
ELECTRICAL CONNECTION	-	3-POLE TERMINAL 2.5mm ²	4-POLE TERMINAL 2.5mm ²	4-POLE TERMINAL 2.5mm ²
OPERATING TEMPERATURE	°C	-10/+70	-10/+70	-10/+70
PROTECTION DEGREE	-	IP54	IP54	IP54
NOISE LEVEL	dB(A)	57(61)	62 (64)	72 (73)
FLOW DIRECTION	-	INSIDE / OUT	INSIDE / OUT	INSIDE / OUT
BEARING	-	BALL	BALL	BALL
SERVICE LIFE	Hour	50.000	50.000	50.000
PLASTIC MATERIAL	-	UL94 V0 ABS FLAME RETARDANT	UL94 V0 ABS FLAME RETARDANT	UL94 V0 ABS FLAME RETARDANT
GASKET	-	POLYURETHANE SEALING	POLYURETHANE SEALING	POLYURETHANE SEALING
WEIGHT	kg	2.68	3.16	3.74
MOUNTING	-	8 PCS M4 SCREWS	8 PCS M4 SCREWS	8 PCS M4 SCREWS
CONFORMITY	-	CE	CE	CE

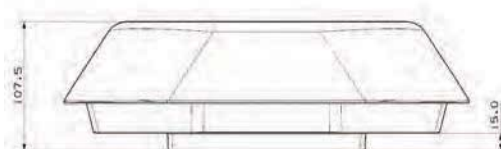
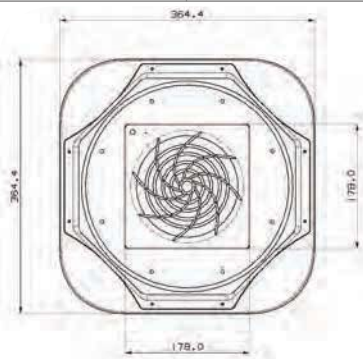

New Products



ROOF FANS

MODELS	UNIT	PTS4000	PTS5500	PTS6000
AIR FLOW RATE	m ³ /h	400	560	970
POWER SUPPLY	V/Hz	230V 50-60Hz	230V 50-60Hz	230V 50-60Hz
DIMENSIONS	mm	364x364x107	364x364x107	364x364x107
POWER CONSUMPTION	W	25/32	58/75	85/90
CURRENT CONSUMPTION	A	0.11/0.15	0.26/0.34	0.38/0.44
OVERCURRENT PROTECTION	-	THERMAL	THERMAL	THERMAL
ELECTRICAL CONNECTION	-	3-POLE TERMINAL 2.5mm ²	3-POLE TERMINAL 2.5mm ²	3-POLE TERMINAL 2.5mm ²
OPERATING TEMPERATURE	°C	-10/+70	-10/+70	-10/+70
PROTECTION DEGREE	-	IP54	IP54	IP54
NOISE LEVEL	dB(A)	62 (64)	62 (64)	72 (73)
FLOW DIRECTION	-	INSIDE / OUT	INSIDE / OUT	INSIDE / OUT
BEARING	-	BALL	BALL	BALL
SERVICE LIFE	Hour	50.000	50.000	50.000
PLASTIC MATERIAL	-	UL94 V0 ABS FLAME RETARDANT	UL94 V0 ABS FLAME RETARDANT	UL94 V0 ABS FLAME RETARDANT
GASKET	-	POLYURETHANE SEALING	POLYURETHANE SEALING	POLYURETHANE SEALING
WEIGHT	kg	2.60	3.16	3.74
MOUNTING	-	FAST CLIP ON	FAST CLIP ON	FAST CLIP ON
CONFORMITY	-	CE	CE	CE

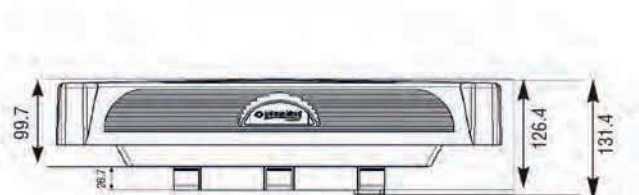
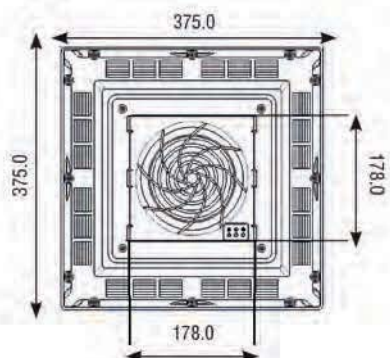



PFI1000



PTF1000



PTF1000T

New!

FILTER FANS

30m³/h

MODELS	UNIT	PFI1000	PTF1000	PTF1000T
AIR FLOW RATE	m ³ /h	-	30 (41)	30 (41)
POWER SUPPLY	V/Hz	-	230V 50-60Hz	230V 50-60Hz
DIMENSIONS	mm	110x110x20.5	110x110x58.5	110x110x58.5
POWER CONSUMPTION	W	-	14 (13)	14 (13)
CURRENT CONSUMPTION	A	-	0.08/0.07	0.08/0.07
OVERCURRENT PROTECTION	-	-	IMPEDANCE	IMPEDANCE
ELECTRICAL CONNECTION	-	-	LEAD WIRE	3-POLE TERMINAL 2.5mm ²
OPERATING TEMPERATURE	°C	-10/+70	-10/+70	-10/+70
PROTECTION DEGREE	-	IP54	IP54 / CLASS I	IP54 / CLASS I
NOISE LEVEL	dB(A)	62 (64)	28 (31)	28 (31)
FLOW DIRECTION	-	-	OUTSIDE-IN	OUTSIDE-IN
BEARING	-	-	SLEEVE	SLEEVE
PLASTIC MATERIAL	-	UL94 V0 ABS FLAME RETARDANT	UL94 V0 ABS FLAME RETARDANT	UL94 V0 ABS FLAME RETARDANT
GASKET	-	SELF-ADHESIVE	SELF-ADHESIVE	SELF-ADHESIVE
COLOR	-	RAL7035 (RAL7032 ON REQUEST)	RAL7035 (RAL7032 ON REQUEST)	RAL7035 (RAL7032 ON REQUEST)
WEIGHT	kg	0.10	0.40	0.40
MOUNTING	-	FAST CLIP ON	FAST CLIP ON	FAST CLIP ON
CONFORMITY	-	CE	CE	CE

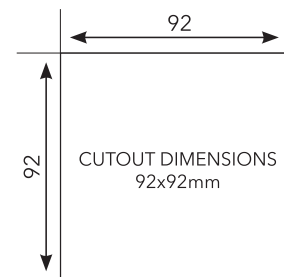
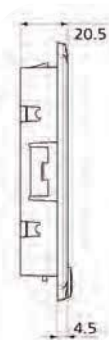
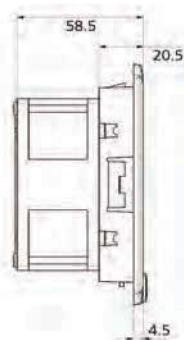
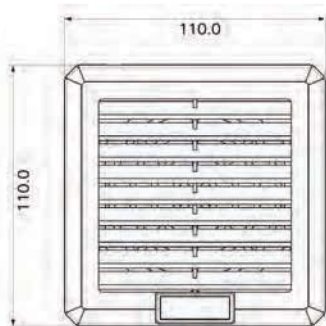

New!



PFI1500



PTF1500



PTF1500T

FILTER FANS

100 m³/h

MODELS	UNIT	PFI1500	PTF1500	PTF1500T
AIR FLOW RATE	m ³ /h	-	100(140)	100(140)
POWER SUPPLY	V/Hz	-	230V 50-60Hz	230V 50-60Hz
DIMENSIONS	mm	160x160x31	160x160x69	160x160x69
POWER CONSUMPTION	W	-	26 (23)	26 (23)
CURRENT CONSUMPTION	A	-	0.14/0.13	0.14/0.13
OVERCURRENT PROTECTION	-	-	IMPEDANCE	IMPEDANCE
ELECTRICAL CONNECTION	-	-	LEAD WIRE	3-POLE TERMINAL 2.5mm ²
OPERATING TEMPERATURE	°C	-10/+70	-10/+70	-10/+70
PROTECTION DEGREE	-	IP54	IP54 / CLASS I	IP54 / CLASS I
NOISE LEVEL	dB(A)	-	42 (46)	42 (46)
FLOW DIRECTION	-	-	OUTSIDE-IN	OUTSIDE-IN
BEARING	-	-	BALL	BALL
PLASTIC MATERIAL	-	UL94 V0 ABS FLAME RETARDANT	UL94 V0 ABS FLAME RETARDANT	UL94 V0 ABS FLAME RETARDANT
GASKET	-	POLYURETHANE SEALING	POLYURETHANE SEALING	POLYURETHANE SEALING
COLOR	-	RAL7035 (RAL7032 ON REQUEST)	RAL7035 (RAL7032 ON REQUEST)	RAL7035 (RAL7032 ON REQUEST)
WEIGHT	kg	0.18	0.68	0.68
MOUNTING	-	FAST CLIP ON	FAST CLIP ON	FAST CLIP ON
CONFORMITY	-	CE	CE	CE

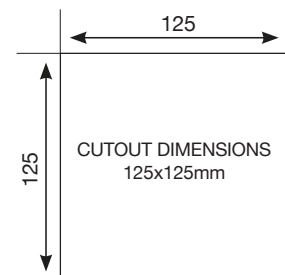
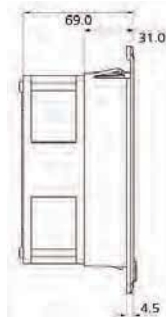
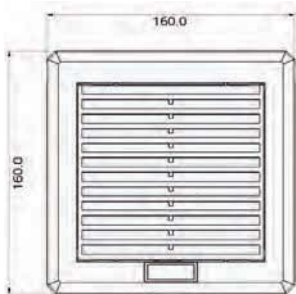



PFI2000



PTF2000



PTF2000

New Products

FILTER FANS

125m³/h

MODELS	UNIT	PFI2000	PTF2000
AIR FLOW RATE	m ³ /h	-	125 (175)
POWER SUPPLY	V/Hz	-	230V 50-60Hz
DIMENSIONS	mm	210x210x31	210x210x98
POWER CONSUMPTION	W	-	26 (23)
CURRENT CONSUMPTION	A	-	0.14/0.13
OVERCURRENT PROTECTION	-	-	IMPEDANCE
ELECTRICAL CONNECTION	-	-	3-POLE TERMINAL
OPERATING TEMPERATURE	°C	-10/+70	-10/+70
PROTECTION DEGREE	-	IP54	IP54 / CLASS I
NOISE LEVEL	dB(A)	-	42 (46)
FLOW DIRECTION	-	-	OUTSIDE-IN
BEARING	-	-	BALL
PLASTIC MATERIAL	-	UL94 V0 ABS FLAME RETARDANT	UL94 V0 ABS FLAME RETARDANT
GASKET	-	POLYURETHANE SEALING	POLYURETHANE SEALING
COLOUR	-	RAL7035 (RAL7032 ON REQUEST)	RAL7035 (RAL7032 ON REQUEST)
WEIGHT	kg	0.35	1.05
MOUNTING	-	FAST CLIP-ON	FAST CLIP-ON
CONFORMITY	-	CE	CE

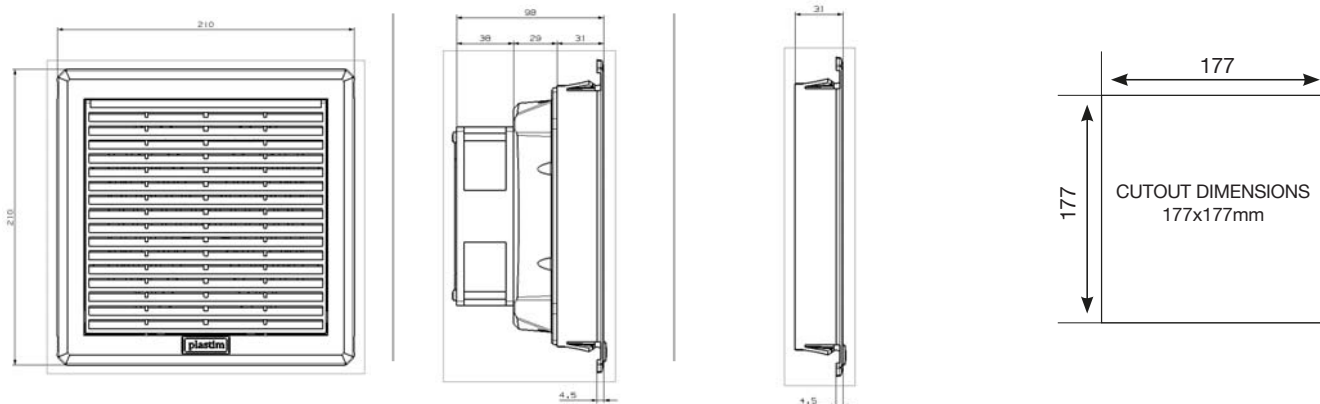



PFI2000



PTF3000



PTF3000

New Products

FILTER FANS

175m³/h

MODELS	UNIT	PFI2000	PTF3000
AIR FLOW RATE	m ³ /h	-	175 (245)
POWER SUPPLY	V/Hz	-	230V 50-60Hz
DIMENSIONS	mm	210x210x31	210x210x92
POWER CONSUMPTION	W	-	37 (35)
CURRENT CONSUMPTION	A	-	0.23/0.22
OVERCURRENT PROTECTION	-	-	IMPEDANCE
ELECTRICAL CONNECTION	-	-	3-POLE TERMINAL
OPERATING TEMPERATURE	°C	-10/+70	-10/+70
PROTECTION DEGREE	-	IP54	IP54 / CLASS I
NOISE LEVEL	dB(A)	-	52 (53)
FLOW DIRECTION	-	-	OUTSIDE-IN
BEARING	-	-	BALL
PLASTIC MATERIAL	-	UL94 V0 ABS FLAME RETARDANT	UL94 V0 ABS FLAME RETARDANT
GASKET	-	POLYURETHANE SEALING	POLYURETHANE SEALING
COLOUR	-	RAL7035 (RAL7032 ON REQUEST)	RAL7035 (RAL7032 ON REQUEST)
WEIGHT	kg	0.35	1.45
MOUNTING	-	FAST CLIP-ON	FAST CLIP-ON
CONFORMITY	-	CE	CE

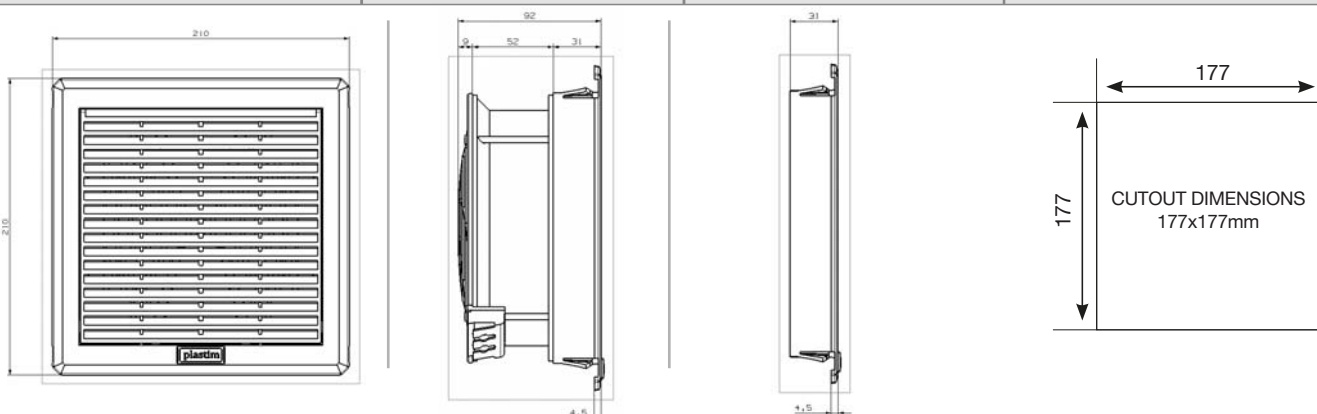

New!



PFI2500



PTF2500



PTF2500

FILTER FANS

115m³/h

MODELS	UNIT	PFI2500	PTF2500
AIR FLOW RATE	m ³ /h	-	115 (130)
POWER SUPPLY	V/Hz	-	230V 50-60Hz
DIMENSIONS	mm	260x260x31	260x260x103
POWER CONSUMPTION	W	-	26 (23)
CURRENT CONSUMPTION	A	-	0.14/0.13
OVERCURRENT PROTECTION	-	-	IMPEDANCE
ELECTRICAL CONNECTION	-	-	3-POLE TERMINAL
OPERATING TEMPERATURE	°C	-10/+70	-10/+70
PROTECTION DEGREE	-	IP54	IP54 / CLASS I
NOISE LEVEL	dB(A)	-	42 (46)
FLOW DIRECTION	-	-	OUTSIDE-IN
BEARING	-	-	BALL
PLASTIC MATERIAL	-	UL94 V0 ABS FLAME RETARDANT	UL94 V0 ABS FLAME RETARDANT
GASKET	-	POLYURETHANE SEALING	POLYURETHANE SEALING
COLOUR	-	RAL7035 (RAL7032 ON REQUEST)	RAL7035 (RAL7032 ON REQUEST)
WEIGHT	kg	0.48	1.18
MOUNTING	-	FAST CLIP-ON	FAST CLIP-ON
CONFORMITY	-	CE	CE

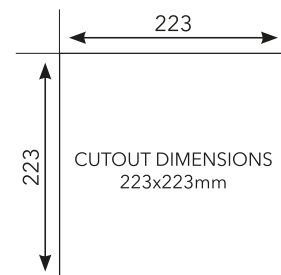
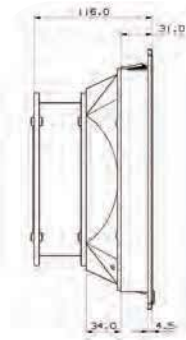
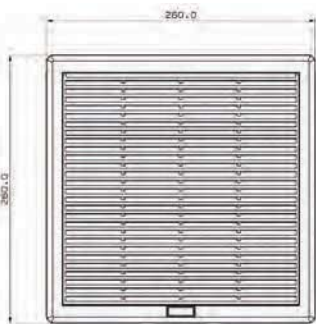



PF12500



PTF3500



PTF3500

FILTER FANS

240m³/h

MODELS	UNIT	PF12500	PTF3500
AIR FLOW RATE	m ³ /h	-	240 (270)
POWER SUPPLY	V/Hz	-	230V 50-60Hz
DIMENSIONS	mm	260x260x31	260x260x103
POWER CONSUMPTION	W	-	37 (35)
CURRENT CONSUMPTION	A	-	0.23/0.22
OVERCURRENT PROTECTION	-	-	IMPEDANCE
ELECTRICAL CONNECTION	-	-	3-POLE TERMINAL
OPERATING TEMPERATURE	°C	-10/+70	-10/+70
PROTECTION DEGREE	-	IP54	IP54 / CLASS I
NOISE LEVEL	dB(A)	-	52 (53)
FLOW DIRECTION	-	-	OUTSIDE-IN
BEARING	-	-	BALL
PLASTIC MATERIAL	-	UL94 V0 ABS FLAME RETARDANT	UL94 V0 ABS FLAME RETARDANT
GASKET	-	POLYURETHANE SEALING	POLYURETHANE SEALING
COLOUR	-	RAL7035 (RAL7032 ON REQUEST)	RAL7035 (RAL7032 ON REQUEST)
WEIGHT	kg	0.48	1.60
MOUNTING	-	FAST CLIP-ON	FAST CLIP-ON
CONFORMITY	-	CE	CE

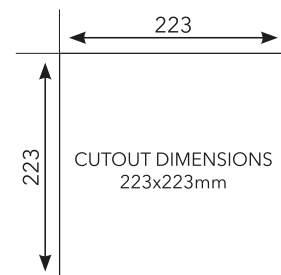
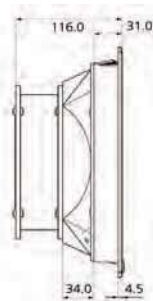



PFI2500



PTF4500



PTF4500

FILTER FANS

650m³/h

MODELS	UNIT	PFI2500	PTF4500
AIR FLOW RATE	m ³ /h	-	650 (900)
POWER SUPPLY	V/Hz	-	230V 50-60Hz
DIMENSIONS	mm	260x260x31	260x260x111
POWER CONSUMPTION	W	-	66 (75)
CURRENT CONSUMPTION	A	-	0.35/0.38
OVERCURRENT PROTECTION	-	-	THERMAL
ELECTRICAL CONNECTION	-	-	4-POLE TERMINAL
OPERATING TEMPERATURE	°C	-10/+70	-10/+70
PROTECTION DEGREE	-	IP54	IP54 / CLASS I
NOISE LEVEL	dB(A)	-	60 (63)
FLOW DIRECTION	-	-	OUTSIDE-IN
BEARING	-	-	BALL
PLASTIC MATERIAL	-	UL94 V0 ABS FLAME RETARDANT	UL94 V0 ABS FLAME RETARDANT
GASKET	-	POLYURETHANE SEALING	POLYURETHANE SEALING
COLOUR	-	RAL7035 (RAL7032 ON REQUEST)	RAL7035 (RAL7032 ON REQUEST)
WEIGHT	kg	0.48	2.84
MOUNTING	-	FAST CLIP-ON	FAST CLIP-ON
CONFORMITY	-	CE	CE

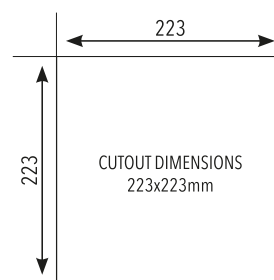



PFI3000



PTF5000



PTF5000

FILTER FANS

850m³/h

MODELS	UNIT	PFI3000	PTF5000
AIR FLOW RATE	m ³ /h	-	850 (1200)
POWER SUPPLY	V/Hz	-	230V 50-60Hz
DIMENSIONS	mm	325x325x31	325x325x111
POWER CONSUMPTION	W	-	110 (140)
CURRENT CONSUMPTION	A	-	0.350/0.72
OVERCURRENT PROTECTION	-	-	THERMAL
ELECTRICAL CONNECTION	-	-	4-POLE TERMINAL
OPERATING TEMPERATURE	°C	-10/+70	-10/+70
PROTECTION DEGREE	-	IP54	IP54 / CLASS I
NOISE LEVEL	dB(A)	-	65 (68)
FLOW DIRECTION	-	-	OUTSIDE-IN
BEARING	-	-	BALL
PLASTIC MATERIAL	-	UL94 V0 ABS FLAME RETARDANT	UL94 V0 ABS FLAME RETARDANT
GASKET	-	POLYURETHANE SEALING	POLYURETHANE SEALING
COLOUR	-	RAL7035 (RAL7032 ON REQUEST)	RAL7035 (RAL7032 ON REQUEST)
WEIGHT	kg	0.70	4.12
MOUNTING	-	FAST CLIP-ON	FAST CLIP-ON
CONFORMITY	-	CE	CE

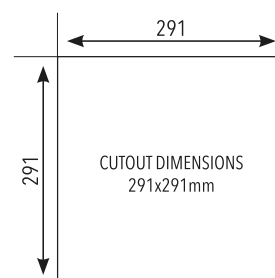
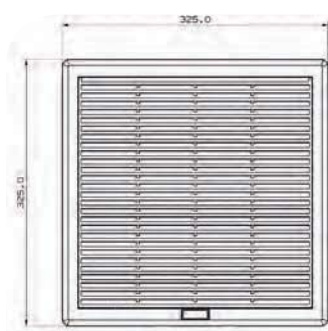

CONTROL





TEMPERATURE CONTROL THERMOSTATS

MODELS	UNIT	PTHT	PTVT
CONTACT FUNCTION	-	NC	NO
TEMPERATURE SETTING RANGE	°C	0-60	0-60
COLOUR OF POTENTIOMETER	-	RED	BLUE
250V AC / 120V AC	A	10 (2)	15 (2)
SENSOR TYPE	-	BIMETAL	
CONTACT TYPE	-	SNAP ACTION	
SERVICE LIFE	Cycle	> 100.000	
ELECTRICAL CONNECTIONS	-	2-POLE TERMINAL	
PLASTIC MATERIAL	-	UL94 V0 ABS FLAME RETARDANT	
PROTECTION DEGREE	EN60529	IP20	
OPERATING TEMPERATURE	°C	-25 / +80	
STORAGE TEMPERATURE	°C	-45 / +80	
MOUNTING	-	CLIP FOR MOUNTING on DIN RAIL 35mm	
INSTALLATION POSITION	-	VARIABLE	
CONFORMITY	-	CE	
DIMENSIONS HxWxD	mm	61x34x38	
WEIGHT	g	45	

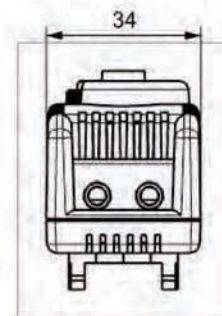
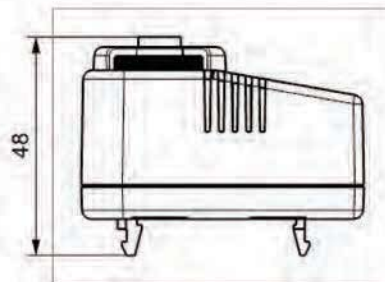
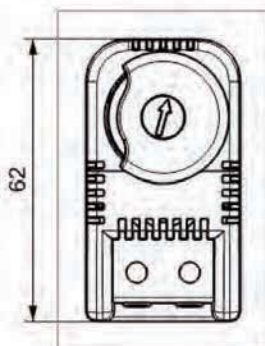



TEMPERATURE CONTROL DUAL THERMOSTAT

MODELS	UNIT	PTHVT
CONTACT FUNCTION	-	NC+NO
TEMPERATURE SETTING RANGE	°C	0-60 / 0-60
COLOUR OF POTENTIOMETER	-	RED + BLUE
250V AC / 120V AC	A	10 (2) / 15 (2)
SENSOR TYPE	-	BIMETAL
CONTACT TYPE	-	SNAP ACTION
SERVICE LIFE	Cycle	> 100.000
ELECTRICAL CONNECTIONS	-	4-POLE TERMINAL
PLASTIC MATERIAL	-	UL94 V0 ABS FLAME RETARDANT
PROTECTION DEGREE	EN60529	IP20
OPERATING TEMPERATURE	°C	-25 / +80
STORAGE TEMPERATURE	°C	-45 / +80
MOUNTING	-	CLIP FOR MOUNTING on DIN RAIL 35mm
INSTALLATION POSITION	-	VARIABLE
CONFORMITY	-	CE
DIMENSIONS HxWxD	mm	65x59x42
WEIGHT	g	80

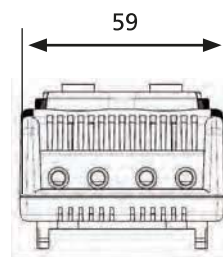
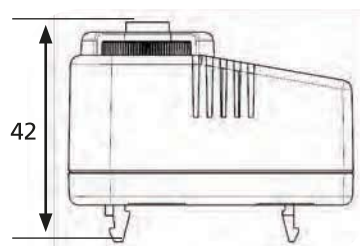
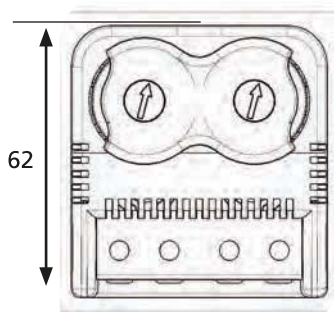

New!



HUMIDITY CONTROL MECHANICAL HYGROSTAT

MODELS	UNIT	PHG02
POWER SUPPLY	V AC	110-250
SETTING RANGE	%RH	10-90
COLOUR OF POTENTIOMETER	-	BLACK
CURRENT	A	10-5
DIFFERENTIAL	-	%5, max. %10
SENSOR TYPE	-	POLYAMIDE RIBBON
ELECTRICAL CONNECTIONS	-	3-POLE TERMINAL
ELECTRICAL SECTION WIRES	-	FROM 0,75mm ² to 4.0mm ²
OPERATING TEMPERATURE	°C	+10 / +60
STORAGE TEMPERATURE	°C	+10 / +60
PROTECTION DEGREE	-	IP20
COLOUR	-	RAL7035
MOUNTING	-	CLIP FOR MOUNTING on DIN RAIL 35mm
DIMENSIONS HxWxD	mm	94x56x54
WEIGHT	g	180
CONFORMITY	-	CE

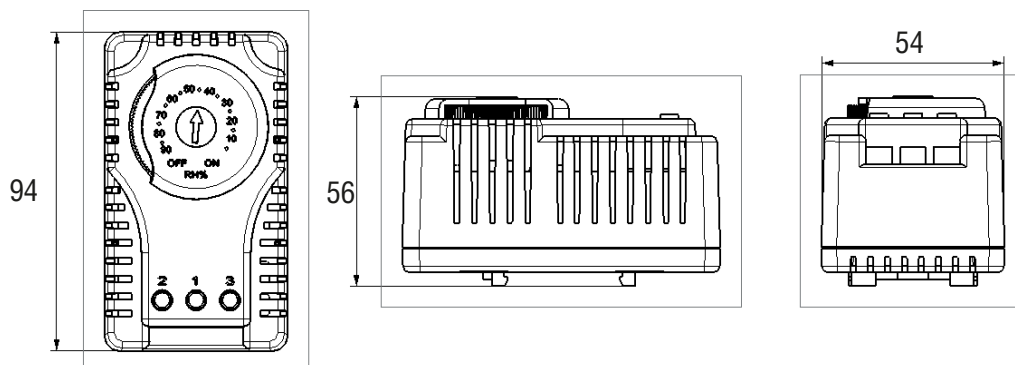

DIGITAL HYGROTHERM

Technical Specifications

- Dimensions : 35x77mm
- Display : 3 Digits 7 Segment
- Sensor Type : Digital Temperature/Humidity sensor
- Measuring Scale : -19.9 .. 80.0 °C, 5 .. 95%RH
- Resolution : ± 1 °C, ± 1 %RH
- Accuracy (typical) : ± 1 %1 (°C), ± 3 %3 (%RH); over full scale
- Control Form : ON-OFF
- °C Out Output : Relay (NO + NC), 250VAC, 2A, Resistive load
- %RH Out Output : Relay (NO), 250VAC, 2A, Resistive load
- °C Function : Ht (heating), CL (cooling);selectable
- %RH Function : lo (decrease humidity), hi (increase humidity);selectable

- Supply Voltage : 100..240VAC, 50 / 60Hz
- Power Consumption : < 6VA
- Operating Temp. : 0 .. 50 °C
- Operating Altitude : H-C; Ht(Heating), CL (Cooling); selectable
- Power Consumption : <6 VA
- Failure : In case of measurement failure, "Err" message displayed and Relay outputs become OFF.

NOTE: The temperature and humidity sensor is included in the device



HT-310

DIGITAL THERMOSTAT

Technical Specifications

- Dimensions : 36x90x65mm, rail mount
- Display : 3 Digits 7 Segment
- Sensor Type : PTC
- Measuring Scale : -50...+150 °C
- Resolution : ± 1 °C
- Accuracy : ± 1 (Over full scale)
- Control Form : ON-OFF
- Out Output : Relay , 250 VAC, 2A, Resistive Load
- Alarm Output : Relay , 250 VAC, 2A, Resistive Load
- Heat Set : LoL...UPL °C (Hst)
- Alarm Set : AtP=Ab s,-Ab; LoL... °C (Ast)
AtP=rEL, -rL; (HSt+rAL) ,(HSt-20) ... (Hst+20) °C
- Heat Hysteresis : 1...20°C (Hhs)
- Alarm Hysteresis : 1...20°C (Hhs)
- Offset : -20...+20 °C (OFS)
- Function : H-C; Ht(Heating), CL (Cooling); selectable
- Supply Voltage : 100...240 VAC, 50/60 Hz
- Power Consumption : <6 VA
- Operating Temperature: -20 °C...55 °C
- Operating Altitude : <2000m
Failure

NOTE: The PTC Sensor is included in the device.



PDT 50- 150

AIR CONDITIONING





PANELTYPE AIR CONDITIONERS

MODELS	UNIT	PAC050.01	PAC075.01	PAC100.01	PAC150.01	PAC200.01	PAC250.01
COOLING CAPACITY	EN814 A35A35	500W	750W	1000W	1500W	2000W	2500W
COOLING CAPACITY	EN814 A35A50	400W	600W	800W	1200W	1600W	2000W
POWER SUPPLY	V / Hz	1 PHASE 230V 50/60 Hz					
DIMENSIONS HxWxD	mm	500x310x205	610x320x210	640x320x210	800x400x255	1000x255x400	1000x255x400
MAX. CURRENT	A	2.65/2.75	2.65/2.75	3.50/3.60	4.50/4.60	6.00	6.00
DELAYED FUSE	A	6	6	10	10	16	16
REFRIGERANT	-	R134a					
OPERATING TEMPERATURE	°C	+20 / +55					
TEMPERATURE CONTROLLER	-	DIGITAL THERMOSTAT FACTORY, SET 35°C					
COMPRESSOR TYPE	-	HERMETIC					
NOISE LEVEL	dB(A)	52	56	62	65	70	70
ELECTRICAL CONNECTIONS	-	3-POLE TERMINAL CONNECTOR					
PROTECTION DEGREE	-	ENCLOSURE INSIDE IP54, AMBIENT INSIDE IP34					
WEIGHT	kg	18.00	26.30	28.50	32.00	43.50	44.00
COLOUR	-	RAL7035 GREY (INOX & IP65 on request)					
CONFORMITY	-	CE					

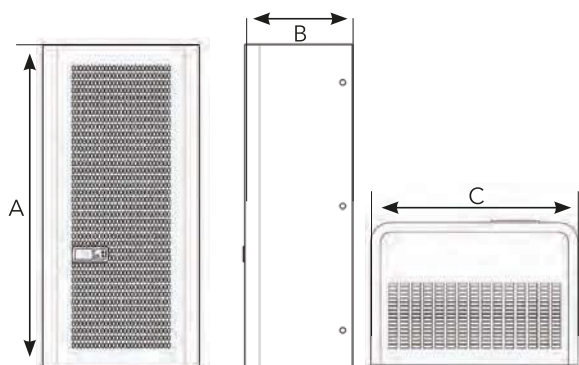

	A(mm)	B(mm)	C(mm)	WEIGHT(kg)
PAC050	500	205	310	18.00
PAC075	610	210	320	26.30
PAC100	640	210	320	28.50
PAC150	800	255	400	32.00
PAC200	1000	255	400	43.50
PAC250	1000	255	400	44.00-

HEATING

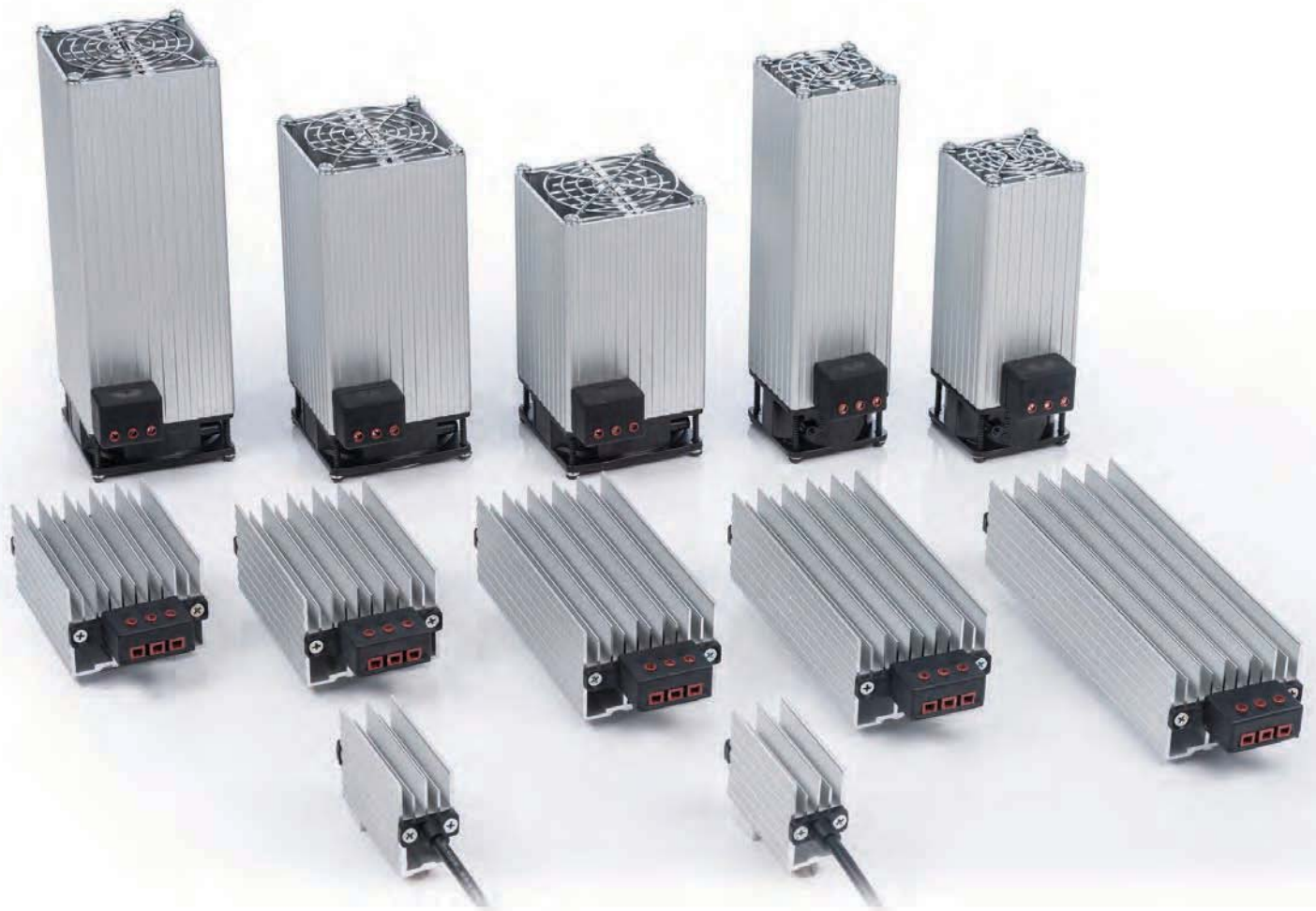



MINI PTC HEATERS

FEATURES	UNIT	MPHT 15	MPHT 25
HEATING CAPACITY	W	15	25
POWER SUPPLY	V	100-250V AC DC	
MAX. CURRENT	A	2A	
HEATING ELEMENT TYPE	-	PTC RESISTOR, SELF REGULATING	
OVERCURRENT PROTECTION	-	ELECTRONIC THERMAL OVERLOAD	
ELECTRICAL CONNECTIONS	-	LEAD WIRE 30cm L-N-E	
PROTECTION CLASS IEC	-	CLASS II	
PROTECTION DEGREE EN60529	-	IP20	
OPERATING TEMPERATURE	°C	-45 / +70	
STORAGE TEMPERATURE	°C	-45 / +70	
RADIATOR	-	ALLUMINIUM PROFILE, ANODIZED	
MOUNTING	-	CLIP FOR MOUNTING on DIN RAIL 35mm	
INSTALLATION POSITION	-	BEST EFFICIENCY IN VERTICAL POSITION	
DIMENSIONS HxWxD	mm	60x50x27	70x50x27
WEIGHT	kg	0.11	0.12
CONFORMITY	-	CE	

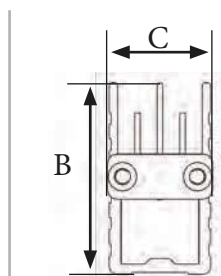
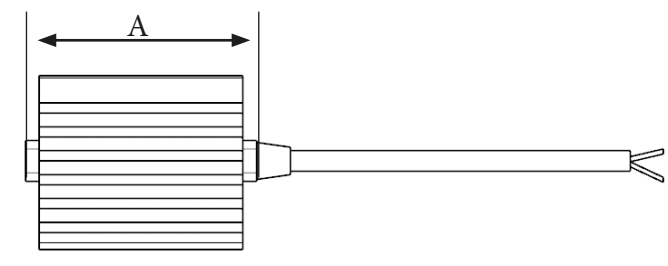

	A	B	C
MPHT15	60	50	27
MPHT25	70	50	27



PTC HEATERS

FEATURES	UNIT	PHT 030	PHT 050	PHT 075	PHT 100	PHT 150
HEATING CAPACITY	W	30	50	75	100	150
POWER SUPPLY	V	100-250V AC DC				
MAX. CURRENT	A	2A	2A	4A	4A	6A
HEATING ELEMENT TYPE	-	PTC RESISTOR, SELF REGULATING				
OVERCURRENT PROTECTION	-	ELECTRONIC THERMAL OVERLOAD				
ELECTRICAL CONNECTIONS	-	3 POLE TERMINAL N-L-E				
PROTECTION CLASS IEC	-	CLASS II				
PROTECTION DEGREE EN60529	-	IP20				
OPERATING TEMPERATURE	°C	-45 / +70				
STORAGE TEMPERATURE	°C	-45 / +70				
RADIATOR	-	ALLUMINIUM PROFILE, ANODIZED				
MOUNTING	-	CLIP FOR MOUNTING on DIN RAIL 35mm				
INSTALLATION POSITION	-	BEST EFFICIENCY IN VERTICAL POSITION				
DIMENSIONS HxWxD	mm	128x70x59	138x70x59	178x70x59	188x70x59	228x70x59
WEIGHT	kg	0.41	0.44	0.54	0.59	0.72
CONFORMITY	-	CE				

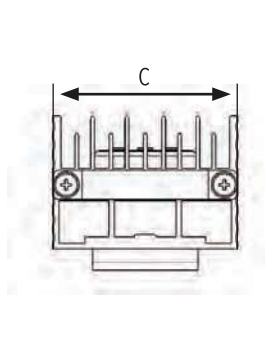
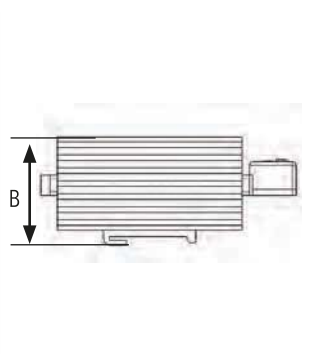
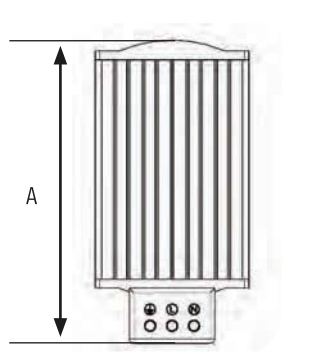

	A	B	C
PHT030	128	59	70
PHT050	138	59	70
PHT075	178	59	70
PHT100	188	59	70
PHT150	228	59	70



PTC HEATERS WITH FAN

FEATURES	UNIT	PFHT 100	PFHT 150
HEATING CAPACITY	W	100	150
POWER SUPPLY	V	100-250V AC DC	
MAX. CURRENT	A	4A	4A
HEATING ELEMENT TYPE	-	PTC RESISTOR, SELF REGULATING	
AXIAL FAN	-	60x60x30mm 16m ³ /h	
OVERCURRENT PROTECTION	-	ELECTRONIC THERMAL OVERLOAD	
ELECTRICAL CONNECTIONS	-	3-POLE TERMINAL N-L-E	
PROTECTION CLASS IEC	-	CLASS II	
PROTECTION DEGREE EN60529	-	IP20	
OPERATING TEMPERATURE	°C	-45 / +70	
STORAGE TEMPERATURE	°C	-45 / +70	
RADIATOR	-	ALLUMINIUM PROFILE, ANODIZED	
MOUNTING	-	CLIP FOR MOUNTING on DIN RAIL 35mm	
INSTALLATION POSITION	-	BEST EFFICIENCY IN VERTICAL POSITION	
DIMENSIONS HxWxD	mm	170x89x60	210x89x60
WEIGHT	kg	0.70	0.94
CONFORMITY	-	CE	

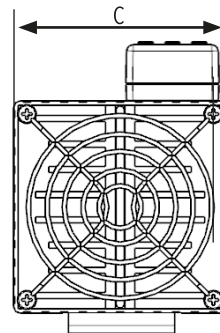
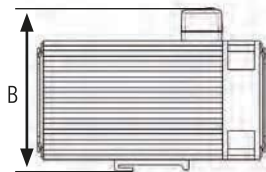
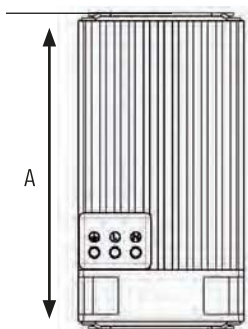

	A	B	C
FPHT100	170	89	60
FPHT150	210	89	60



RESISTANCE HEATERS WITH FAN

FEATURES	UNIT	PFHT 250	PFHT 500	PFHT 750
HEATING CAPACITY	W	250	500	750
POWER SUPPLY	V	230V 50/60Hz		
MAX. CURRENT	A	1.2A	2.4A	3.6A
HEATING ELEMENT TYPE	-	RESISTANCE HEATER		
AXIAL FAN	-	80x80x25mm 35m ³ /h		
OVERCURRENT PROTECTION	-	ELECTRONIC THERMAL OVERLOAD		
ELECTRICAL CONNECTIONS	-	3-POLE TERMINAL N-L-E		
PROTECTION CLASS IEC	-	CLASS I, EARTHED		
PROTECTION DEGREE EN60529	-	IP20		
OPERATING TEMPERATURE	°C	-25 / +70		
STORAGE TEMPERATURE	°C	-25 / +70		
RADIATOR	-	ALLUMINIUM PROFILE, ANODIZED		
MOUNTING	-	CLIP FOR MOUNTING on DIN RAIL 35mm		
INSTALLATION POSITION	-	BEST EFFICIENCY IN VERTICAL POSITION		
DIMENSIONS HxWxD	mm	152x80x110	182x80x110	232x80x110
WEIGHT	kg	0.98	1.20	1.45
CONFORMITY	-	CE		

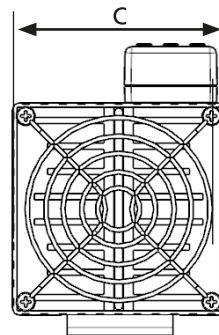
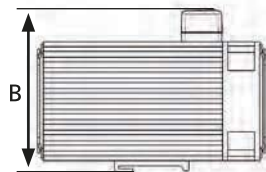
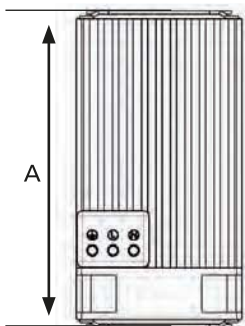

	A	B	C
PFHT250	152	110	80
PFHT500	182	110	80
PFHT750	232	110	80



PANEL ACCESSORIES

CODE	DESCRIPTION	PACK IN PCS
PFM 1000	FILTER MAT FOR PFI 1000	10
PFM 1500	FILTER MAT FOR PFI 1500	10
PFM 2500	FILTER MAT FOR PFI 2500	10
PFM 3000	FILTER MAT FOR PFI 3000	10

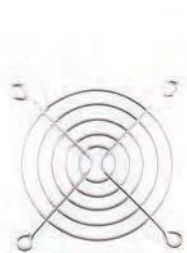

PT0808



PT1212



PT1717

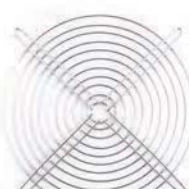

PT2020

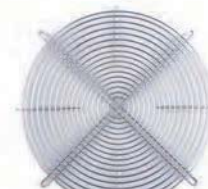

PT2525

CODE	DESCRIPTION	PACK IN PCS
PT 0808	METALLIC PROTECTION GRILL FOR 80x80mm	100
PT 1212	METALLIC PROTECTION GRILL FOR 120x120mm	100
PT 1717	METALLIC PROTECTION GRILL FOR 170x170mm	100
PT 2020	METALLIC PROTECTION GRILL FOR 225x225mm	100
PT 2525	METALLIC PROTECTION GRILL FOR 280x280mm	100



PPCA4



PPCA5

New!

CODE	DESCRIPTION	PACK IN PCS
PPCA5	DRAWING POCKET A5 SIZE	10
PPCA4	DRAWING POCKET A4 SIZE	10

DISTRIBUTION BLOCKS

CODE	NUMBER OF POLES AND CURRENT	DISTRIBUTION BLOCKS	DIMENSIONS	PCS
PDB 207	2 Pole 125 Amper	5*5,3+2*7,5 (2x7 Pole)	65x45,5x51 mm	50
PDB 211	2 Pole 125 Amper	9*5,3+2*7,5 (2x11 Pole)	100x45,5x51 mm	50
PDB 215	2 Pole 125 Amper	11*5,3+2*7,5+2*9.0 mm (2x15 Pole)	132x45,5x51 mm	50
PDB 407	4 Pole 125 Amper	5*5,3+2*7,5 (4x7 Pole)	65x89,5x50 mm	50
PDB 411	4 Pole 125 Amper	7*5,3+2*7,5+2*9.0 mm (4x11 Pole)	100x89,5x50 mm	50
PDB 415	4 Pole 125 Amper	9*5,3+2*7,5+2*9.0 mm (4x15 Pole)	132x89,5x51 mm	50



PDB207



PDB211



PDB215



PDB407



PDB411



PDB415

COPPER TUBULAR CABLE LUGS



CODE	CROSS SECTION	BOLT Ø	D4	WALL THICKNESS	A	D1	B	C1	C2	L	PACKAGE QTY
SKP10-5	10 mm	M5	6,2	0,75	13,3	4,7	10,5	7,2	8,8	29,8	800
SKP16-6	16 mm	M6	7,9	0,75	18,5	6,4	11,8	7,1	7,5	33,5	500
SKP25-8	25 mm	M8	9,0	0,85	22,1	7,3	13,2	7,8	9,0	38,6	300
SKP35-8	35 mm	M8	10,8	1,15	25,5	8,5	15,5	9,3	9,6	44,5	200
SKP35-10	35 mm	M10	10,8	1,15	25,5	8,5	15,5	9,3	9,6	44,5	200
SKP50-10	50 mm	M10	12,6	1,30	28,6	10,0	18,2	10,8	12,1	51,5	150
SKP70-10	70 mm	M10	14,5	1,50	34,5	11,5	21,0	10,8	10,0	55,0	100
SKP95-10	95 mm	M10	16,5	1,50	37,0	13,5	24,2	10,85	12,0	60,0	80
SKP95-12	95 mm	M12	16,5	1,50	37,0	13,5	24,2	10,85	12,0	60,0	80
SKP120-12	120 mm	M12	19,1	1,80	43,0	15,5	28,0	13,9	13,2	70,0	50
SKP150-12	150 mm	M12	20,6	1,80	43,2	17,0	30,2	16,3	16,0	75,5	30
SKP185-16	185 mm	M16	22,6	1,90	47,3	18,8	33,5	17,0	18,6	83,0	30
SKP240-16	240 mm	M16	25,2	2,00	54,7	21,2	37,5	17,35	18,2	90,0	25

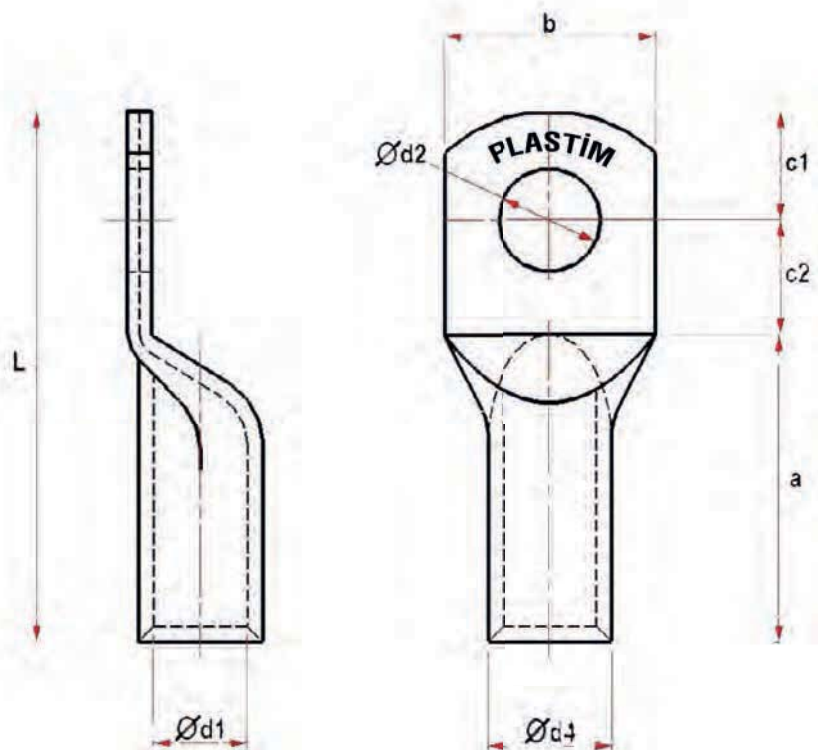

DIN RAILS AND SUPPORT



PRODUCT CODE	DESCRIPTION	TYPE	LENGTH	PACKING QTY
PDR1001	35x7.5mm	Un Perforated	1mt	20
PDR1002	35x7.5mm	Un Perforated	2mt	20
PDR2001	35x7.5mm	Perforated	1mt	20
PDR2002	35x7.5mm	Perforated	2mt	20

PRODUCT CODE	DESCRIPTION	TYPE	LENGTH	PACKING QTY
PDR3001	35x15mm	Un Perforated	1mt	10
PDR3002	35x15mm	Un Perforated	2mt	10
PDR4001	35x15mm	Perforated	1mt	10
PDR4002	35x15mm	Perforated	2mt	10



PRODUCT CODE	DESCRIPTION	PACKING / QTY
PRT	DIN Rail Support	25 Pcs

PET EXPANDABLE BRAIDED SLEEVING

**New
Products**







- Halogen free
- VW-1 Flame Retardant
- -60...+150C
- RoHS

CODE	DESCRIPTION	SPOOL LENGHT
PKC-03	PET Expandable Braided Sleeving 3 mm Black	100m
PKC-06	PET Expandable Braided Sleeving 6 mm Black	100m
PKC-08	PET Expandable Braided Sleeving 8 mm Black	100m
PKC-10	PET Expandable Braided Sleeving 10 mm Black	100m
PKC-12	PET Expandable Braided Sleeving 12 mm Black	100m
PKC-15	PET Expandable Braided Sleeving 15 mm Black	100m
PKC-20	PET Expandable Braided Sleeving 20 mm Black	50m
PKC-25	PET Expandable Braided Sleeving 25 mm Black	50m
PKC-30	PET Expandable Braided Sleeving 30 mm Black	50m
PKC-40	PET Expandable Braided Sleeving 40 mm Black	50m
PKC-50	PET Expandable Braided Sleeving 50 mm Black	25m













CABLE TERMINALS

Insulated Cord End Terminals German Norm

Product Code	Color	Cross Section	Dimensions					Package Qty
			[F]	[L]	[W]	[B]	[D]	
PKY-2005		0,50	8	14	2,6	6,0	1,3	1000
PKY-2007		0,75	8	14	2,8	6,3	1,5	1000
PKY-2010		1,00	8	14	3,0	6,3	1,7	1000
PKY-2015		1,50	8	14	3,5	6,3	2,0	1000
PKY-2025		2,50	8	14	4,2	7,4	2,5	500
PKY-2040		4,00	10	17	4,8	7,4	3,2	500
PKY-2060		6,00	12	20	6,3	8,5	3,9	250
PKY-2100		10,00	12	22	7,6	8,8	4,9	100
PKY-2160		16,00	12	24	8,8	10,0	6,2	100
PKY-2250		25,00	16	28	11,2	12,0	7,7	50
PKY-2350		35,00	16	30	12,7	14,0	8,7	50
PKY-2500		50,00	20	36	15,0	16,0	10,9	25







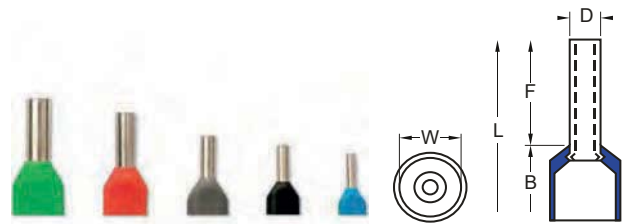



Insulated Cord End Terminals French Norm

Product Code	Color	Cross Section	Dimensions					Package Qty
			[F]	[L]	[W]	[B]	[D]	
PKY-3005		0,50	8	14	2,6	6,0	1,3	1000
PKY-3007		0,75	8	14	2,8	6,3	1,5	1000
PKY-3010		1,00	8	14	3,0	6,3	1,7	1000
PKY-3015		1,50	8	14	3,5	6,3	2,0	1000
PKY-3025		2,50	8	14	4,2	7,4	2,5	500
PKY-3040		4,00	10	17	4,8	7,4	3,2	500
PKY-3060		6,00	12	20	6,3	8,5	3,9	250
PKY-3100		10,00	12	22	7,6	8,8	4,9	100
PKY-3160		16,00	12	24	8,8	10,0	6,2	100
PKY-3250		25,00	16	28	11,2	12,0	7,7	50
PKY-3350		35,00	16	30	12,7	14,0	8,7	50
PKY-3500		50,00	20	36	15,0	16,0	10,9	25











CABLE TERMINALS

Insulated Twin Cord End Terminals German Norm

Product Code	Color	Cross Section	Dimensions					Package Qty
			[F]	[L]	[W]	[B]	[D]	
PKY-22005		2x0,50	8	14	5,0	6,5	1,8	1000
PKY-22007		2x0,75	8	14	5,5	6,7	2,1	500
PKY-22010		2x1,00	8	14	5,5	7,1	2,4	500
PKY-22015		2x1,50	8	14	6,4	7,5	2,6	500
PKY-22025		2x2,50	10	14	8,0	8,5	3,3	250
PKY-22040		2x4,00	12	17	8,0	11,1	4,2	200
PKY-22060		2x6,00	14	20	9,5	12,1	5,3	100
PKY-22100		2x10,00	14	27	12,6	12,6	6,9	50
PKY-22160		2x16,00	14	31	19,0	19,0	8,7	25







Insulated Twin Cord End Terminals French Norm







Product Code	Color	Cross Section	Dimensions					Package Qty
			[F]	[L]	[W]	[B]	[D]	
PKY-23005		2x0,50	8	14	5,0	6,5	1,8	1000
PKY-23007		2x0,75	8	14	5,5	6,7	2,1	500
PKY-23010		2x1,00	8	14	5,5	7,1	2,4	500
PKY-23015		2x1,50	8	14	6,4	7,5	2,6	500
PKY-23025		2x2,50	10	14	8,0	8,5	3,3	250
PKY-23040		2x4,00	12	17	8,0	11,1	4,2	200
PKY-23060		2x6,00	14	20	9,5	12,1	5,3	100
PKY-23100		2x10,00	14	27	12,6	12,6	6,9	50
PKY-23160		2x16,00	14	31	19,0	19,0	8,7	25









CABLE TERMINALS

Ring Type Insulated Cable Terminals

Product Code	Cross Section	Bolt Size	Dimensions (mm)				Package Qty
			[D2]	[I]	[D4]	[A]	
PYK-301 	0,50-1,50mm	M3	3,2	16,0	4,0	10,0	200
PYK-401 	0,50-1,50mm	M4	4,3	17,0	4,0	10,0	200
PYK-501 	0,50-1,50mm	M5	5,3	18,0	4,0	10,0	200
PYK-601 	0,50-1,50mm	M6	6,5	18,0	4,0	10,0	200
PYK-801 	0,50-1,50mm	M8	8,4	22,0	4,0	10,0	200

Product Code	Cross Section	Bolt Size	Dimensions (mm)				Package Qty
			[D2]	[I]	[D4]	[A]	
PYK-302 	1,50-2,50mm	M3	3,2	16,0	4,5	10,0	200
PYK-402 	1,50-2,50mm	M4	4,3	17,0	4,5	10,0	200
PYK-502 	1,50-2,50mm	M5	5,3	19,0	4,5	10,0	200
PYK-602 	1,50-2,50mm	M6	6,5	21,0	4,5	10,0	200
PYK-802 	1,50-2,50mm	M8	8,4	22,0	4,5	10,0	200
PYK-1002 	1,50-2,50mm	M10	10,5	22,0	4,5	10,0	200

Product Code	Cross Section	Bolt Size	Dimensions (mm)				Package Qty
			[D2]	[I]	[D4]	[A]	
PYK-406 	4,00-6,00mm	M4	4,3	21,0	6,3	13,0	100
PYK-506 	4,00-6,00mm	M5	5,3	22,0	6,3	13,0	100
PYK-606 	4,00-6,00mm	M6	6,5	22,5	6,3	13,0	100
PYK-806 	4,00-6,00mm	M8	8,4	26,0	6,3	13,0	100
PYK-1006 	4,00-6,00mm	M10	10,5	28,0	6,3	13,0	100
PYK-1206 	4,00-6,00mm	M12	13,0	28,0	6,3	13,0	100

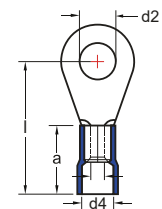

CABLE TERMINALS

Fork Type - Insulated Cable Terminals

Product Code	Cross Section	Bolt Size	Dimensions (mm)				Package Qty
			[D2]	[I]	[D4]	[A]	
PCK-301	0,50-1,50mm	M3	3,2	16,0	4,0	10,0	200
PCK-401	0,50-1,50mm	M4	4,3	17,0	4,0	10,0	200
PCK-501	0,50-1,50mm	M5	5,3	18,0	4,0	10,0	200
PCK-601	0,50-1,50mm	M6	6,5	20,0	4,0	10,0	200

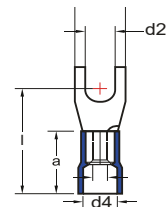



Product Code	Cross Section	Bolt Size	Dimensions (mm)				Package Qty
			[D2]	[I]	[D4]	[A]	
PCK-302	1,50-2,50mm	M3	3,2	18,0	4,5	10,0	200
PCK-402	1,50-2,50mm	M4	4,3	17,0	4,5	10,0	200
PCK-502	1,50-2,50mm	M5	5,3	19,0	4,5	10,0	200
PCK-602	1,50-2,50mm	M6	6,5	21,0	4,5	10,0	200

Product Code	Cross Section	Bolt Size	Dimensions (mm)				Package Qty
			[D2]	[I]	[D4]	[A]	
PCK-406	4,00-6,00mm	M4	8,4	22,0	4,5	10,0	100
PCK-506	4,00-6,00mm	M5	10,5	22,0	4,5	10,0	100
PCK-606	4,00-6,00mm	M6	13,0	25,0	4,5	10,0	100
PCK-806	4,00-6,00mm	M8	4,0	21,0	6,3	13,0	100





CABLE TERMINALS

Insulated Female Terminals

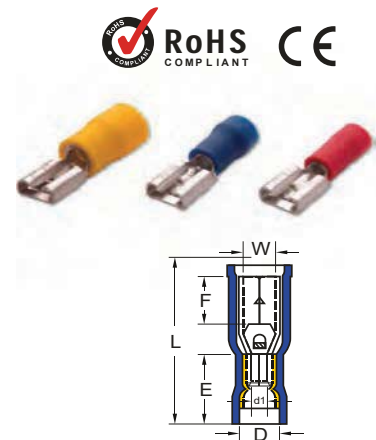
Product Code	Cross Section	Dimensions (mm)					Package Qty
		[W]	[F]	[L]	[E]	[D]	
PFT-1040 	0,50-1,50mm	3,9	7,0	23,3	10,5	3,8	200
PFT-2050 	1,50-2,50mm	4,9	7,0	23,3	10,5	4,7	100
PFT-5050 	4,00-6,00mm	4,9	7,0	25,1	12,5	6,2	100



Insulated Male Terminals

Product Code	Cross Section	Dimensions (mm)					Package Qty
		[W]	[F]	[L]	[E]	[D]	
PMT-1040 	0,50-1,50mm	4,0	8,5	21,5	10,5	3,8	200
PMT-2050 	1,50-2,50mm	5,0	8,5	21,2	10,5	4,7	100
PMT-5050 	4,00-6,00mm	5,0	8,5	24,0	13,0	6,2	100

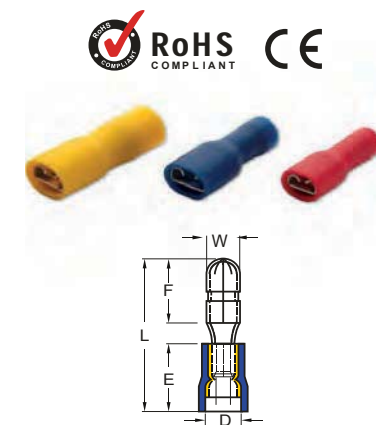

Insulated Pin Type Terminals

Product Code	Cross Section	Dimensions (mm)					Package Qty
		[W]	[F]	[L]	[E]	[D]	
PKI-101 	0,50-1,50mm	1,9	10,0	19,0	10,0	4,0	200
PKI-102 	1,50-2,50mm	1,9	12,0	21,8	10,0	4,5	200
PKI-106 	4,00-6,00mm	2,8	14,0	27,0	27,0	6,4	100



CABLE TERMINALS

Insulated Female Disconnectors

Product Code	Cross Section	Socket Width	Dimensions (mm)					Package Qty
			[W]	[F]	[L]	[E]	[D]	
PFD-1288	0,50-1,50mm	0,8x2,80	3,2	6,5	19,0	10,5	3,8	200
PFD-1488	0,50-1,50mm	0,8x4,75	5	6,4	19,4	10,5	3,8	200
PFD-1638	0,50-1,50mm	0,8x6,35	6,6	7,5	20,8	10,5	3,8	200
PFD-2488	1,50-2,50mm	0,8x4,75	5	6,4	19,4	10,5	4,7	200
PFD-2638	1,50-2,50mm	0,8x6,35	6,6	7,5	20,8	10,5	4,7	200
PFD-5638	4,00-6,00mm	0,8x6,35	6,6	7,5	23,3	13,0	6,2	100

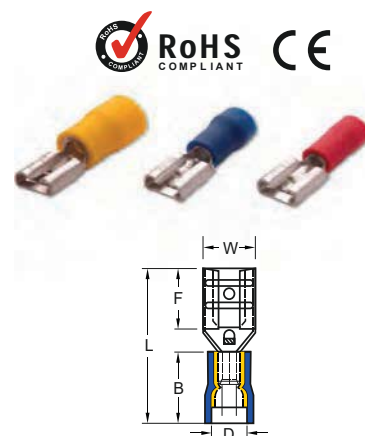

Fully Insulated Female Disconnectors

Product Code	Cross Section	Socket Width	Dimensions (mm)					Package Qty
			[W]	[F]	[L]	[E]	[D]	
PFD-1288	0,50-1,50mm	0,8x2,80	3,2	6,5	19,0	10,5	3,8	200
PFD-1488	0,50-1,50mm	0,8x4,75	5	6,4	19,4	10,5	3,8	200
PFD-1638	0,50-1,50mm	0,8x6,35	6,6	7,5	20,8	10,5	3,8	200
PFD-2488	1,50-2,50mm	0,8x4,75	5	6,4	19,4	10,5	4,7	200
PFD-2638	1,50-2,50mm	0,8x6,35	6,6	7,5	20,8	10,5	4,7	200
PFD-5638	4,00-6,00mm	0,8x6,35	6,6	7,5	23,3	13,0	6,2	100

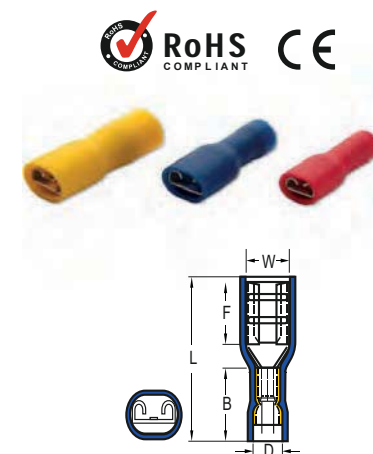

Insulated Male Disconnectors

Product Code	Cross Section	Socket Width	Dimensions (mm)					Package Qty
			[W]	[F]	[L]	[E]	[D]	
PFE-1288	0,50-1,50mm	0,8x2,80	2,8	6,5	19,2	10,5	3,8	200
PFE-1488	0,50-1,50mm	0,8x4,75	4,8	6,7	19,8	10,5	3,8	200
PFE-1638	0,50-1,50mm	0,8x6,35	6,35	7,7	21,8	10,5	3,8	200
PFE-2488	1,50-2,50mm	0,8x4,75	4,8	6,7	19,8	10,5	4,7	200
PFE-2638	1,50-2,50mm	0,8x6,35	6,35	7,7	21,8	10,5	4,7	200
PFE-5638	4,00-6,00mm	0,8x6,35	6,35	7,7	24,0	13,0	6,2	100

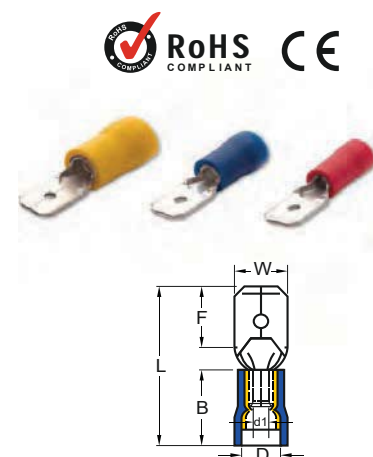

PBO PUSH BUTTON SERIES



PBO PUSH BUTTON SERIES

Q22mm

	PRODUCT CODE	HEAD COLOR	DESCRIPTION	CONTACT	PACKAGE QTY
	PBO-AA31	Green	Push Button Green	1NO	10
	PBO-AA42	Red	Push Button Red	1NC	10
	PBO-AA51	Yellow	Push Button Yellow	1NO	10
	PBO-AA61	Blue	Push Button Blue	1NO	10
	PBO-AA11	White	Push Button White	1NO	10
	PBO-AA21	Black	Push Button Black	1NO	10
	PBO-AW31B5	White	LED Illuminated Push Button 24V White	1NO	10
	PBO-AW33B5	Green	LED Illuminated Push Button 24V Green	1NO	10
	PBO-AW34B5	Red	LED Illuminated Push Button 24V Red	1NC	10
	PBO-AW35B5	Yellow	LED Illuminated Push Button 24V Yellow	1NO	10
	PBO-AW36B5	Blue	LED Illuminated Push Button 24V Blue	1NO	10
	PBO-AW31M5	White	LED Illuminated Push Button 220V White	1NO	10
	PBO-AW33M5	Green	LED Illuminated Push Button 220V Green	1NO	10
	PBO-AW34M5	Red	LED Illuminated Push Button 220V Red	1NC	10
	PBO-AW35M5	Yellow	LED Illuminated Push Button 220V Yellow	1NO	10
	PBO-AW36M5	Blue	LED Illuminated Push Button 220V Blue	1NO	10
	PBO-AC42	Red	Mushroom Red Button	1NC	10
	PBO-AC31	Green	Mushroom Green Button	1NO	10
	PBO-AS542	Red	Emergency Stop Red	1NC	10
	PBO-AS542-24L	Red	LED Emergency Stop 24V Red	1NC	10
	PBO-AS542-230L	Red	LED Emergency Stop 220V Red	1NC	10

PBO PUSH BUTTON SERIES

Q22mm

	PRODUCT CODE	HEAD COLOR	DESCRIPTION	CONTACT	PACKAGE QTY
	PBO-AD21	Black	0-1 Selector	1NO	10
	PBO-AD33	Black	1-0-2 Selector	2NO	10
	PBO-AD53	Black	1-0-2 Selector Spring Turn	2NO	10
	PBO-AD41	Black	0-1 Selector Spring Turn	1NO	10
	PBO-AJ21	Black	0-1 Selector Long Handle	1NO	10
	PBO-AJ33	Black	1-0-2 Selector Long Handle	2NO	10
	PBO-AJ53	Black	1-0-2 Selector Spring Turn Long Handle	2NO	10





	PBO-AK123B5	Green	LED Illuminated Selector 0-1 Button 24V Green	1NO	10
	PBO-AK124B5	Red	LED Illuminated Selector 0-1 Button 24V Red	1NC	10
	PBO-AK125B5	Yellow	LED Illuminated Selector 0-1 Button 24V Yellow	1NO	10
	PBO-AK123M5	Green	LED Illuminated Selector 0-1 Button 220V Green	1NO	10
	PBO-AK124M5	Red	LED Illuminated Selector 0-1 Button 220V Red	1NC	10
	PBO-AK125M5	Yellow	LED Illuminated Selector 0-1 Button 220V Yellow	1NO	10

	PBO-AK133B5	Green	LED Illuminated Selector 1-0-2 Button 24V Green	2NO	10
	PBO-AK134B5	Red	LED Illuminated Selector 1-0-2 Button 24V Red	2NC	10
	PBO-AK135B5	Yellow	LED Illuminated Selector 1-0-2 Button 24V Yellow	2NO	10
	PBO-AK133M5	Green	LED Illuminated Selector 1-0-2 Button 220V Green	2NO	10
	PBO-AK134M5	Red	LED Illuminated Selector 1-0-2 Button 220V Red	2NC	10
	PBO-AK135M5	Yellow	LED Illuminated Selector 1-0-2 Button 220V Yellow	2NO	10

	PBO-AG21	Black	Selector Button With Keylock 0-1	1NO	10
	PBO-AG33	Black	Selector Button With Keylock 1-0-2	2NO	10

PB0 PUSH BUTTON SERIES

Q22mm

	PRODUCT CODE	HEAD COLOR	DESCRIPTION	CONTACT	PACKAGE QTY
	PBO-AL73415	 Red+Green	Twin Button	1NO+1NC	10
	PBO-AW734B5	 Red+Green	LED Twin Button 24V	1NO+1NC	10
	PBO-AW734M5	 Red+Green	LED Twin Button 220V	1NO+1NC	10

	PBO-LS22-24R	 Red	LED Pilot Light Q22mm 24V Red	- -	10	
	PBO-LS22-24G	 Green	LED Pilot Light Q22mm 24V Green	- -	10	
	PBO-LS22-24Y	 Yellow	LED Pilot Light Q22mm 24V Yellow	- -	10	
	PBO-LS22-24W	 White	LED Pilot Light Q22mm 24V White	- -	10	
	PBO-LS22-24B	 Blue	LED Pilot Light Q22mm 24V Blue	- -	10	
		PBO-LS22-220R	 Red	LED Pilot Light Q22mm 220V Red	- -	10
		PBO-LS22-220G	 Green	LED Pilot Light Q22mm 220V Green	- -	10
		PBO-LS22-220Y	 Yellow	LED Pilot Light Q22mm 220V Yellow	- -	10
		PBO-LS22-220W	 White	LED Pilot Light Q22mm 220V White	- -	10
		PBO-LS22-220B	 Blue	LED Pilot Light Q22mm 220V Blue	- -	10

	PBO-B22-24	 Black	Buzzer 24VAC-DC Black	- -	10	
	PBO-B22-220	 Black	Buzzer 220VAC-DC Black	- -	10	
		PBO-LB22-24R	 Red	Flash Buzzer Q22mm 24V AC-DC Red	- -	10
		PBO-LB22-220R	 Red	Flash Buzzer Q22mm 220V AC-DC Red	- -	10

PBO PUSH BUTTON SERIES AND SIGNAL ACCESSORIES

Q22mm



CODE	COLOR	DESCRIPTION	CONTACT
PB-BK 01Y	Yellow-Black	1 Hole Push Button Box	- -
PB-BK 01G	Grey-Black	1 Hole Push Button Box	- -
PB-BK 02G	Grey-Black	2 Hole Push Button Box	- -
PB-BK 03G	Grey-Black	3 Hole Push Button Box	- -
PB-BK 04G	Grey-Black	4 Hole Push Button Box	- -
PB-BK 05G	Grey-Black	5 Hole Push Button Box	- -



PB0-KB01	NC Contact	NC Contact	1NC
PB0-KB10	NO Contact	NO Contact	1NO



PB0-A-M5		Button LED Contact 220VAC	- -
PB0-A-B5		Button LED Contact 24VAC-DC	- -

PB-SB22	Silicon Button Protection Top Q22 Transparent	- -
PB-BSA	Button Stud Clamping Tool	- -
PB-ES60	Emergency Stop Label Q60	- -
PB-ES90	Emergency Stop Label Q90	- -
PB-BR2515	Label for Q22 Button	- -
PB-KT22	Panel Plug Q22	- -
PB-BK0	Protection Cover Oval	- -
PB-BKY	Protection Cover Round	- -



PB-SB22



PB-BSA



PB-ES60



PB-BR2515



PB-KT22



PB-BK0



PB-BKY

Description				Class		
Series	Code	Hole (mm)	Primary (A)	Class 0.5	Class 1.0	Class 3.0
PCK20	PCK20405	20	40	-	-	1.5 VA
	PCK25005	20	50	-	-	1.5 VA
	PCK20605	20	60	-	-	2.5 VA
	PCK20805	20	80	-	-	2.5 VA
	PCK201005	20	100	-	2.5 VA	-
	PCK201255	20	125	-	2.5 VA	-
	PCK201505	20	150	-	2.5 VA	-
	PCK202005	20	200	-	3.75 VA	-
	PCK202505	20	250	3.75 VA	3.75 VA	-
	PCK203505	20	300	3.75 VA	3.75 VA	-
PTK30S	PTK30S305	30	30	-	1.5VA(3PT)	-
	PTK30S405	30	40	-	1.5VA(3PT)	-
	PTK30S505	30	50	-	1.5VA(2PT)	-
	PTK30S605	30	60	-	2.5 VA(2PT)	-
	PTK30S805	30	80	-	2.5 VA(2PT)	-
	PTK30S1005	30	100	-	1.5 VA	-
	PTK30S1255I	30	125	2.5 VA	2.5 VA	-
	PTK30S1505	30	150	2.5 VA	2.5 VA	-
	PTK30S1605	30	160	2.5 VA	2.5 VA	-
	PTK30S2005	30	200	3.75 VA	3.75 VA	-
PTK30	PTK30605	30	60	-	1.5 VA	-
	PTK30805	30	80	-	1.5 VA	-
	PTK301005	30	100	2.5 VA	2.5 VA	-
	PTK301255P	30	125	-	2.5 VA	-
	PTK301505	30	150	2.5 VA	2.5 VA	-
	PTK301605	30	160	2.5 VA	2.5 VA	-
	PTK302005	30	200	2.5 VA	2.5 VA	-
	PTK302505	30	250	2.5 VA	2.5 VA	-
	PTK303005	30	300	-	5 VA	-
	PTK304005	30	400	5 VA	5 VA	-
PTK305005	30	500	10 VA	10 VA	-	
PTK306005	30	600	5 VA	5 VA	-	

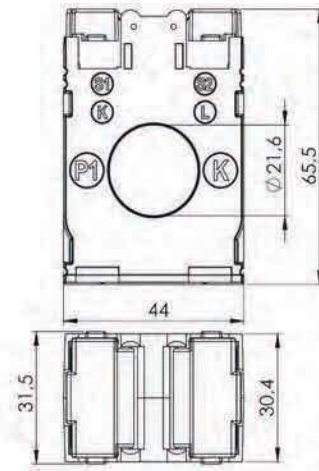

NEW

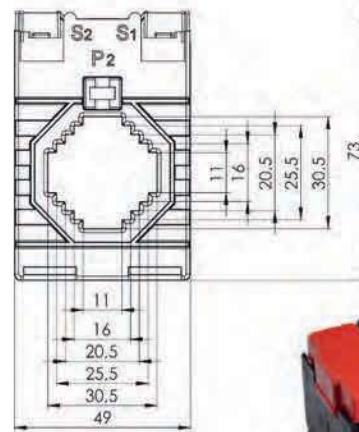

NEW

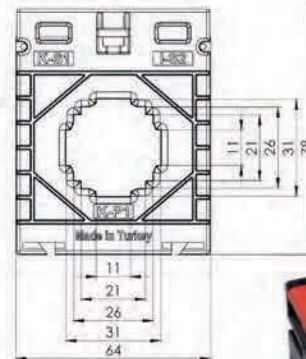
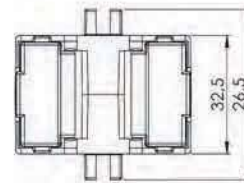

NEW

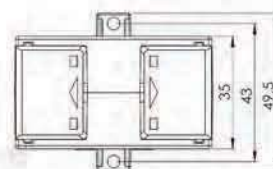

Description				Class		
Series	Code	Hole (mm)	Primary (A)	Class 0.5	Class 1.0	Class 3.0
PCK20	PCK20405	20	40	-	-	1.5 VA
	PCK25005	20	50	-	-	1.5 VA
	PCK20605	20	60	-	-	2.5 VA
	PCK20805	20	80	-	-	2.5 VA
	PCK201005	20	100	-	2.5 VA	-
	PCK201255	20	125	-	2.5 VA	-
	PCK201505	20	150	-	2.5 VA	-
	PCK202005	20	200	-	3.75 VA	-
	PCK202505	20	250	3.75 VA	3.75 VA	-
	PCK203505	20	300	3.75 VA	3.75 VA	-
PTK30S	PTK30S305	30	30	-	1.5VA(3PT)	-
	PTK30S405	30	40	-	1.5VA(3PT)	-
	PTK30S505	30	50	-	1.5VA(2PT)	-
	PTK30S605	30	60	-	2.5 VA(2PT)	-
	PTK30S805	30	80	-	2.5 VA(2PT)	-
	PTK30S1005	30	100	-	1.5 VA	-
	PTK30S1255I	30	125	2.5 VA	2.5 VA	-
	PTK30S1505	30	150	2.5 VA	2.5 VA	-
	PTK30S1605	30	160	2.5 VA	2.5 VA	-
	PTK30S2005	30	200	3.75 VA	3.75 VA	-
PTK30	PTK30605	30	60	-	1.5 VA	-
	PTK30805	30	80	-	1.5 VA	-
	PTK301005	30	100	2.5 VA	2.5 VA	-
	PTK301255P	30	125	-	2.5 VA	-
	PTK301505	30	150	2.5 VA	2.5 VA	-
	PTK301605	30	160	2.5 VA	2.5 VA	-
	PTK302005	30	200	2.5 VA	2.5 VA	-
	PTK302505	30	250	2.5 VA	2.5 VA	-
	PTK303005	30	300	-	5 VA	-
	PTK304005	30	400	5 VA	5 VA	-
PTK305005	30	500	10 VA	10 VA	-	
PTK306005	30	600	5 VA	5 VA	-	

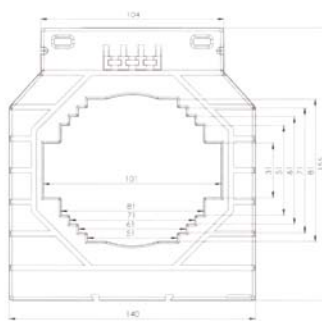
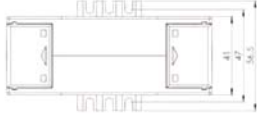
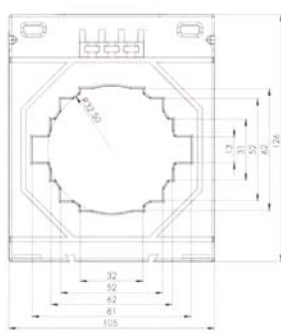
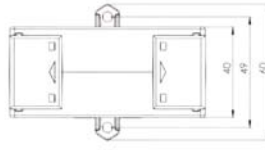
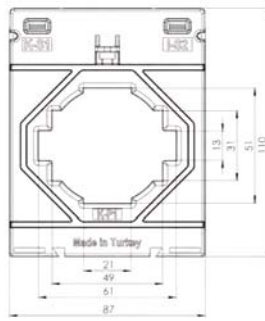
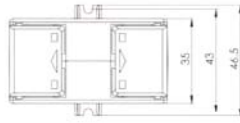
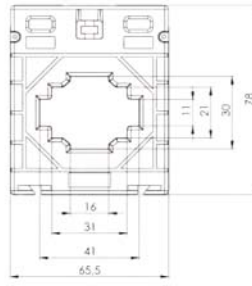

Description				Class		
Series	Code	Hole (mm)	Primary (A)	Class 0.5	Class 1.0	Class 3.0
PLDK125	PLDK12512005	125	1200	20	30	-
	PLDK12512505	125	1250	30	30	-
	PLDK12515005	125	1500	15	20	-
	PLDK12516005	125	1600	15	20	-
	PLDK12520005	125	2000	25	30	-
	PLDK12525005	125	2500	30	30	-
	PLDK12530005	125	3000	-	30	-
	PLDK12532005	125	3200	30	30	-
	PLDK12540005	125	4000	30	40	-

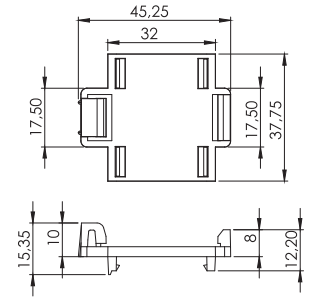
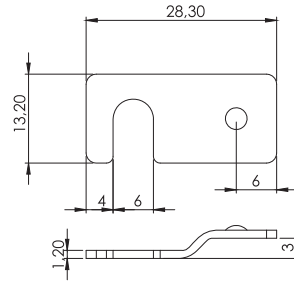
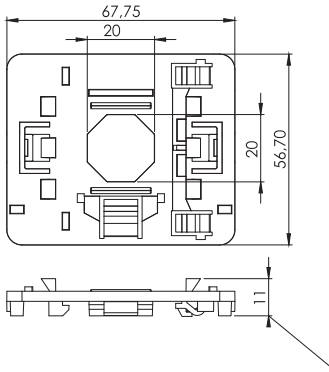
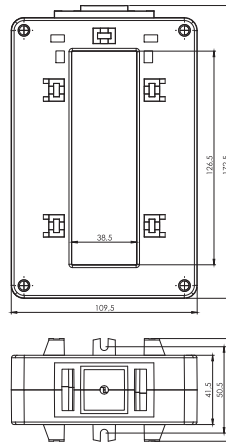

A.C. ANALOG METERS, 90°, X/1A, X/5A				
Series	Code	Product	Size	Scale
PAK	PAK-A72	AMPERMETER	72x72 mm	0-500A
	PAK-V72	VOLTMETER	72x72 mm	300V 500V 600V
	PAK-A96	AMPERMETER	96x96 mm	0-500A
	PAK-V96	VOLTMETER	96x96 mm	300V 500V 600V

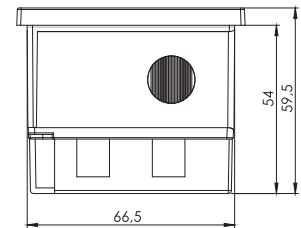
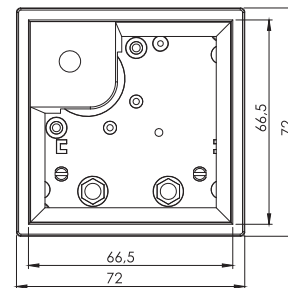
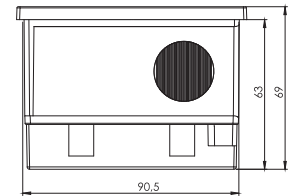
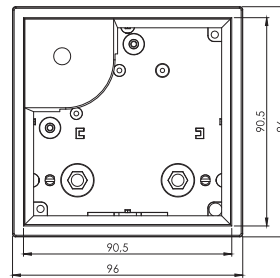

NOTES

A series of horizontal dashed lines for writing notes.



It has always been **Plastim's** main principal to use the **highest technology** for its production

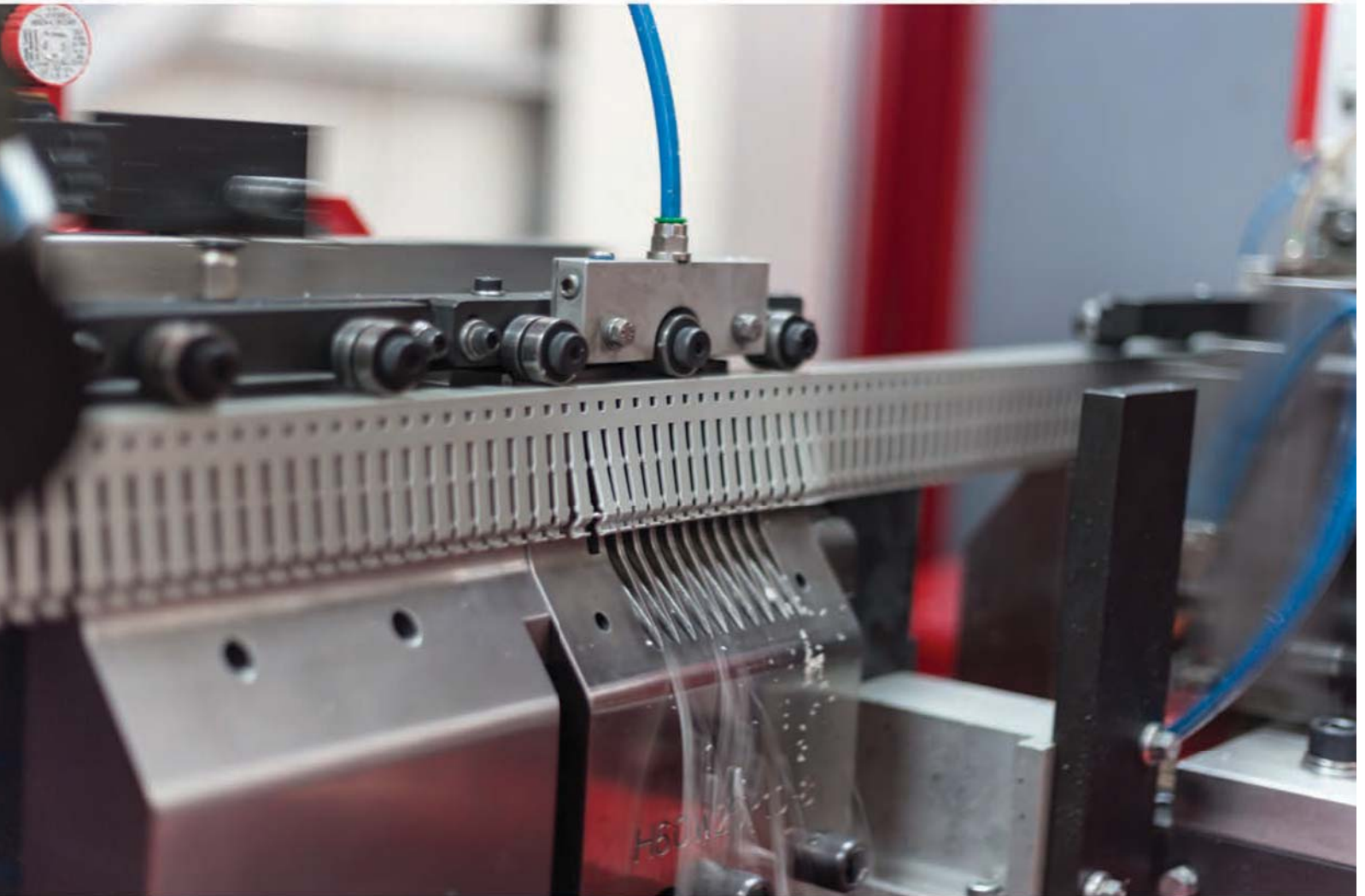

The **fastest**
cable duct punching machine
in the world (10mt/min)

PTC Fan Heaters



NEW

NEW

PSHT Series New Slim Heaters



NEW

Current Transformers



PLASTİM ELEKTRİK MALZEMELERİ İMALAT SAN. TİC. LTD. ŞTİ.

HEADQUARTERS: Perpa Elektrokent A Blok Kat: 2 No: 37 34384 Okmeydanı - İstanbul / Turkey
Tel: +90 212 210 17 10 Fax: +90 212 221 72 37

FACTORY 1: Alipaşa Mahallesi Boztepe Sokak No: 5 34570 Silivri - İstanbul / Turkey

FACTORY 2: İkitelli OSB Fatih Sanayi Sitesi 4A Blok No: 3-4 34306 Başakşehir - İstanbul / Turkey

From Turkey to **worldwide!**

- ALGERIA
- AUSTRALIA
- AZERBAIJAN
- BOSNIA HERZEGOVINA
- BULGARIA
- COLOMBIA
- CZECH REPUBLIC
- CROATIA
- EGYPT
- ENGLAND
- ECUADOR
- FINLAND
- GERMANY
- GREECE
- HONDURAS
- HUNGARY
- ICELAND
- INDONESIA
- IRAQ
- IRAN
- IRELAND
- ISRAEL
- ITALY
- JORDAN
- KUWAIT
- LATVIA
- LEBANON
- LIBYA
- MOROCCO
- MALDIVES
- MEXICO
- NETHERLAND
- NIGERIA
- PALESTINE
- PAKISTAN
- PERU
- POLAND
- PORTUGAL
- QATAR
- ROMANIA
- RUSSIA
- SAUDI ARABIA
- SERBIA
- SPAIN
- SOUTH AFRICA
- SRI LANKA
- SWITZERLAND
- TAIWAN
- THAILAND
- TUNISIA
- UKRAINE
- UAE
- USA
- VIETNAM



X-ON Electronics

Largest Supplier of Electrical and Electronic Components

Click to view similar products for [Temperature Sensor Modules](#) category:

Click to view products by [PLASTIM](#) manufacturer:

Other Similar products are found below :

[HPP809A031](#) [MBT 3560-0000-0050-10-110](#) [MBT 3560-0000-0100-10-110](#) [MBT 3560-0001-0050-10-120](#) [MBT 3560-0001-0100-10-120](#)
[TCN4L-22R](#) [TX4H-14R](#) [TX4H-24R](#) [TX4H-A4R](#) [TX4H-B4R](#) [TX4L-14R](#) [TX4L-A4R](#) [TX4L-B4R](#) [TX4M-14R](#) [TX4M-24R](#) [TX4M-A4R](#)
[TX4M-B4R](#) [QP99](#) [CP-02](#) [CP82](#) [CP99](#) [R38-LAOO](#) [R38-LARR](#) [72-11304023-0150.0050](#) [72-11304027-0150.0050](#) [72-23304003-](#)
[0150.0050.GGP](#) [72-23904001-0300.0040.TM](#) [72-34904001-0300.0040.TM](#) [TEM 73 A](#) [AT403-414-1000](#) [AT403-614-1000](#) [AT-503-1141-000](#)
[AT-503-1161-000](#) [AT-503-6140-000](#) [AT-603-1141-000](#) [AT603-414-1000](#) [AT-903-1161-000](#) [ATR121-AD](#) [ATR121-B](#) [TPMC-5](#) [TPMC-8W](#)
[K39-HCRR](#) [K39T-HCRR](#) [K49-HCRR](#) [K49P-HCRR](#) [K85-HERR](#) [KR1-LCRR-D](#) [LHI874](#) [LHI944](#) [LHI968](#)