



HVR 250P Series PTC Devices

HVR 250P Series PTC Devices

Description

The HVR 250P series provide protection against induced AC power current, direct power contact and the natural lightning strike. It offers a wide range in hold current from 0.08 to 0.18 A with 60Vdc of operating voltage and 250Vac of interrupt voltage.

Features





- RoHS compliant and lead-free
- Halogen-free
- Fast time-to-trip
- 60Vdc operating voltage
- 250Vac interrupt voltage





Applications

- IT equipment
- Access network equipment
- Central office equipment
- ISDN and xDSL equipments
- Phone set and fax machine
- LAN/WAN and VoIP cards

Agency Approval and Environmental Compliance

Agency	File Number	Regulation	Standard
	E201431		2011/65/EU
	R50103297		IEC 61249-2-21:2003

Electrical Characteristics

Part Number	I _{hold} (A)	I _{trip} (A)	V _{max}		I _{max} (A)	P _{d typ} (W)	Maximum Time To Trip		Resistance			Agency Approval	
			Interrupt (V _{dc})	Operating (V _{dc})			Current (A)	Time (Sec.)	R _{min} (Ω)	R _{max} (Ω)	R _{1max} (Ω)		
HVR250P080CF	0.08	0.16	250	60	3	1.0	0.35	4.0	14.0	22.0	33.0	✓	✓
HVR250P120CF	0.12	0.24	250	60	3	1.0	1.00	2.5	4.0	8.0	16.0	✓	✓
HVR250P145CF	0.145	0.29	250	60	3	1.0	1.00	2.5	3.0	6.0	14.0	✓	✓
HVR250P180CF	0.18	0.65	250	60	10	1.8	1.00	20.0	0.8	2.2	4.0	✓	✓

■ Vocabulary

I_{hold} = Hold current: maximum current device will pass without tripping in 23°C still air.

I_{trip} = Trip current: minimum current at which the device will trip in 23 °C still air.

V_{max} = Maximum voltage device can withstand without damage at rated current (I_{max})

V_{op} = Maximum continuous voltage device can withstand without damage at rated current (I_{max})

I_{max} = Maximum fault current device can withstand without damage at rated voltage (V_{max})

P_{d typ} = Typical power dissipated from device when in the tripped state at 23 °C still air.

R_{min} = Minimum resistance of device in initial (un-soldered) state.

R_{1max} = Maximum resistance of device at 23 °C measured one hour after tripping or reflow soldering of 260 °C for 20 sec.

■ **Caution:** Operation beyond the specified rating may result in damage and possible arcing and flame.

■ Specifications are subject to change without notice.

HVR 250P Series PTC Devices

Polymeric PTC Selecting Guide

- Determine the following operating parameters for the circuits:
 - Normal operating current (I_{hold})
 - Maximum interrupt current (I_{max})
 - Maximum circuit voltage (V_{max})
 - Normal operating temperature surrounding device (min°C/max°C)
- Select the device form factor and dimension suitable for the application:
 - Surface Mount Device (SMD)
 - Axial Leaded Device (ALD)
 - Radial Leaded Device (RLD)
 - DISC Device
 - Other Customized Form Factors
- Compare the maximum rating for V_{max} and I_{max} of the PPTC device with the circuit in application and make sure the circuit's requirement does not exceed the device rating.
- Check that PPTC device's trip time (time-to-trip) will protect the circuit.
- Verify that the circuit operating temperature is within the PPTC device's normal operating temperature range.
- Verify the performance and suitability of the chosen PPTC device in the application.

WARNING

- **Mechanical Stress**
 - PPTC devices will undergo a thermal expansion during fault condition. If PPTC devices are installed or placed in an application where the space between PPTC devices and the surrounding materials (e.g., covering materials, packaging materials, encapsulate materials and the like) is insufficient, it will cause an inhibiting effect upon the thermal expansion. Pressing, twisting, bending and other kinds of mechanical stress will also adversely affect the performance of the PPTC devices, and shall not be used or applied.
- **Chemical Pollutants**
 - Silicone-based oils, oils, solvents, gels, electrolytes, fuels, acids, and the like will adversely affect the properties of PPTC devices, and shall not be used or applied.
- **Electronic and Thermal Effect**
 - PPTC devices are secondary protection devices and are used solely for sporadic, accidental over-current or over-temperature error condition, and shall NOT be used if or when constant or repeated fault conditions (such fault conditions may be caused by, among others, incorrect pin-connection of a connector) or over-extensive trip events may occur.
 - PPTC devices are different from fuses and, when a fault condition occurs, will go into high-resistance state and do not open circuit, in which case the voltage at such PPTC devices may reach a hazardous level.
 - Operation over the maximum rating or other forms of improper use may cause failure, arcing, flame and/or other damage to the PPTC devices.
 - Conductive material contamination, such as metal particle, may induce shortage, flame or arcing.
 - Due to the inductance, the operation circuits may generate a circuit voltage (Ldi/dt) above the rated voltage of PPTC devices, which shall not be used under such circumstances.
- **General**
 - Customers shall evaluate and test the properties of PPTC devices independently to verify and ensure that their individual applications will be met.
 - The performance of PPTC devices will be adversely affected if they are improperly used under electronic, thermal and/or mechanical procedures and/or conditions non-conformant to those recommended by manufacturer.
 - Customers shall be responsible for determining whether it is necessary to have back-up, failsafe and/or fool-proof protection to avoid or minimize damage that may result from extra-ordinary, irregular function or failure of PPTC devices.
 - Any and all responsibilities and liabilities are disclaimed if any item under this notice of warning is not complied with.

HVR 250P Series PTC Devices

Typical Time-to-Trip Curves

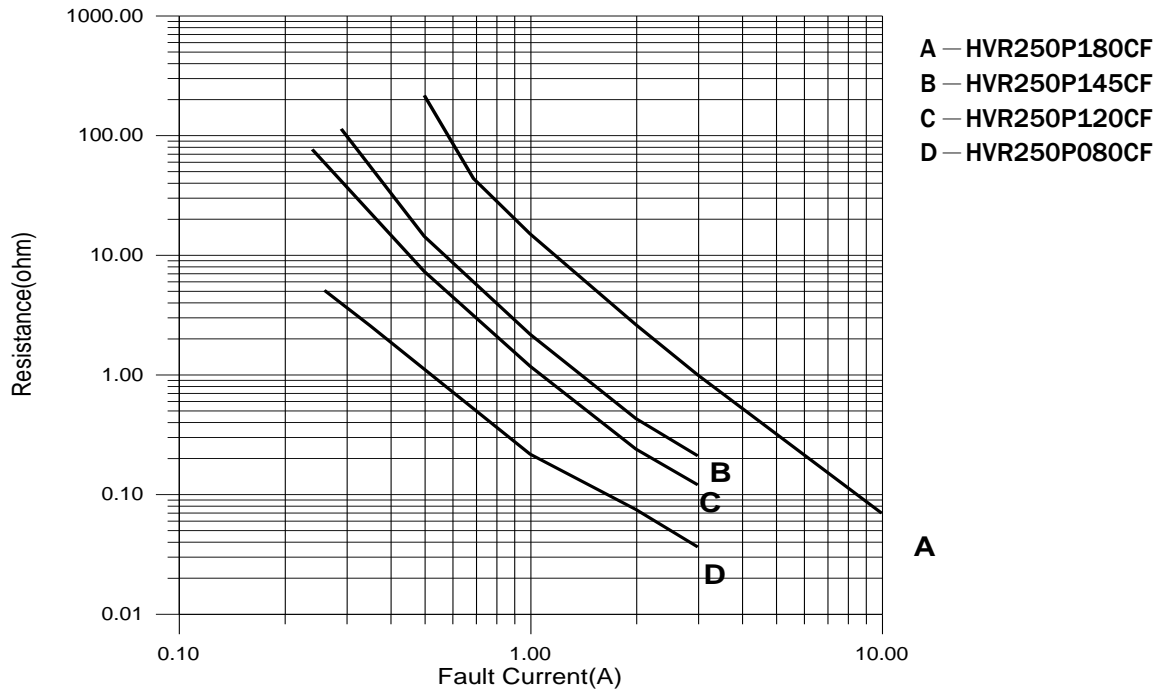

HVR 250P Series PTC Devices

Thermal Derating Curve

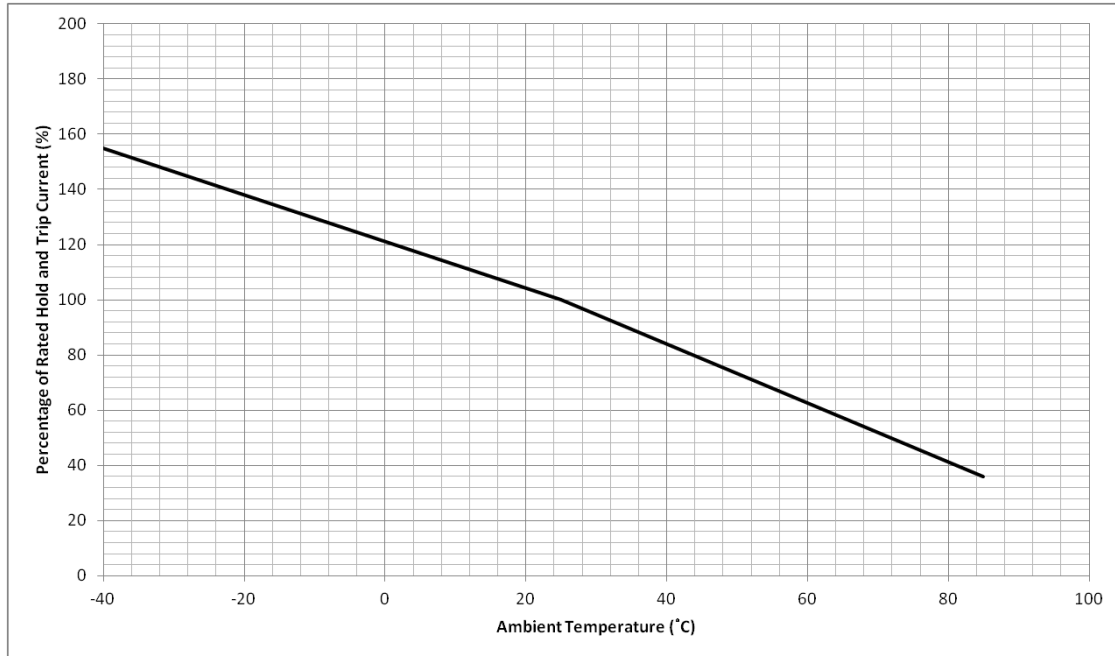

Thermal Derating Table

Recommended Hold Current (A) vs. Ambient Temperature (°C)

Part Number	Ambient Operation Temperature								
	-40 °C	-20 °C	0 °C	23 °C	40 °C	50 °C	60 °C	70 °C	85 °C
HVR250P080CF	0.124	0.110	0.096	0.080	0.066	0.058	0.049	0.041	0.029
HVR250P120CF	0.186	0.165	0.144	0.120	0.099	0.087	0.074	0.062	0.043
HVR250P145CF	0.225	0.199	0.174	0.145	0.120	0.105	0.090	0.075	0.052
HVR250P180CF	0.279	0.248	0.216	0.180	0.148	0.130	0.111	0.093	0.065

HVR 250P Series PTC Devices

Physical Dimensions (mm.)

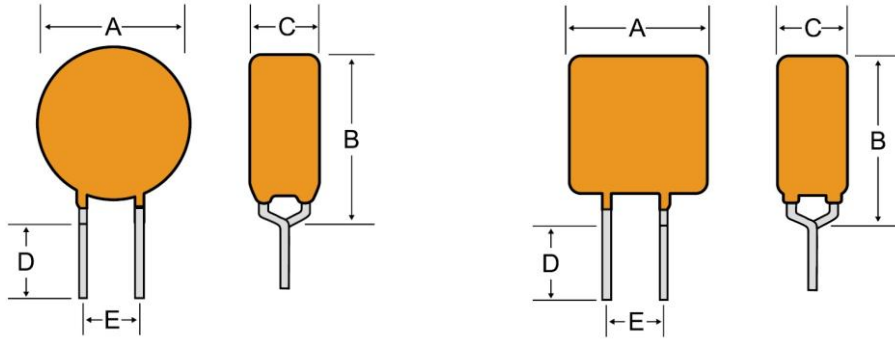
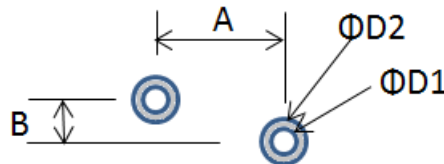

Fig. 1

Fig. 2

Part Number	A Max.	B Max.	C Max.	D Min.	E Typ.	Lead		Fig.
						Dia. (Max)	Material	
HVR250P080CF	5.8	9.9	4.6	4.7	5.1±0.7	0.65	Sn/Cu	1
HVR250P120CF	6.8	11.0	4.6	4.7	5.1±0.7	0.65	Sn/Cu	2
HVR250P145CF	6.8	11.0	4.6	4.7	5.1±0.7	0.65	Sn/Cu	2
HVR250P180CF	9.5	12.0	4.6	4.7	5.1±0.7	0.65	Sn/Cu	1

Recommend Pad Layout (mm)



Part Number	A (Typ.)	B (Typ.)	D1 (Typ.)	D2 (Typ.)
HVR250P080CF	5.1	0	1.2	3.0
HVR250P120CF	5.1	0	1.2	3.0
HVR250P145CF	5.1	0	1.2	3.0
HVR250P180CF	5.1	0	1.2	3.0

HVR 250P Series PTC Devices

Wave Soldering Parameters

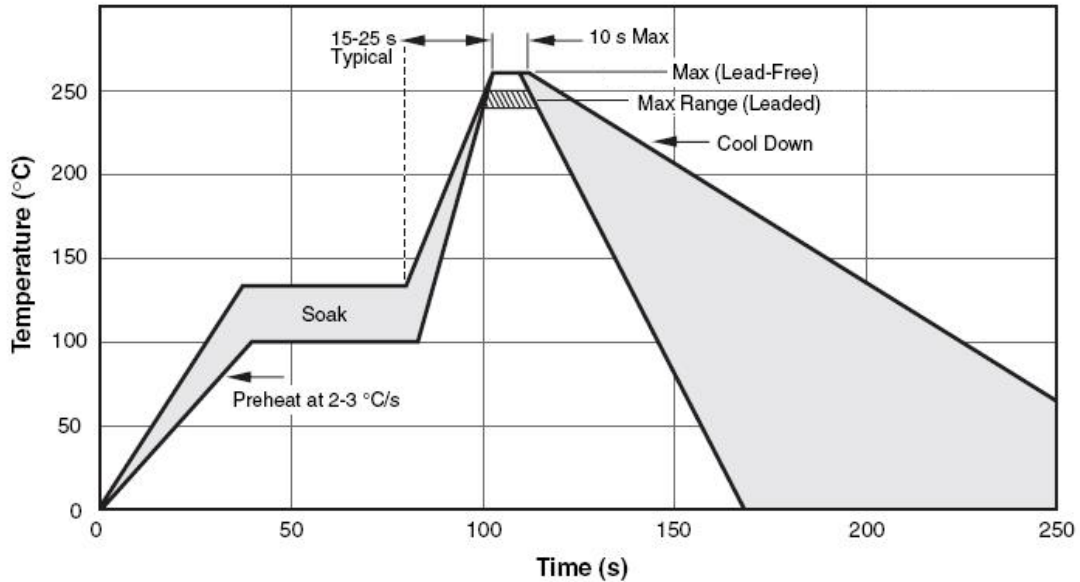

Profile Feature	Pb-Free Assembly
Average Ramp-Up Rate ($T_{s_{max}}$ to T_P)	4°C/second max.
Preheat	
-Temperature Min ($T_{s_{min}}$)	100°C
-Temperature Max ($T_{s_{max}}$)	125°C
-Time ($T_{s_{min}}$ to $T_{s_{max}}$)	60-180 seconds
Peak Temperature (T_P)	265°C
Max Time at Peak Temperature (t_P)	5 seconds
Ramp-Down Rate	6 °C /second max.
Time 25°C to Peak Temperature	5 minutes max.
Storage Condition	0°C ~35°C, ≤ 70%RH, 2 year

Note: If the wave soldering temperatures exceed the recommended profile, devices may not meet the performance requirements.

HVR 250P Series PTC Devices

Environmental Specifications

Operating Temperature	-40°C to +85 °C
Maximum Device Surface Temperature in Tripped State	125°C
Passive Aging	+85°C , 1000 hours ±5% typical resistance change
Humidity Aging	+85°C , 85%R.H. 1000 hours ±5% typical resistance change
Thermal Shock	MIL-STD-202 Method 107G +85°C /-40°C 10 times -30% typical resistance change
Solvent Resistance	MIL-STD-202, Method 215 No change
Vibration	MIL-STD-883C, Method 2007.1, Condition A No change
Moisture Sensitivity Level	Level 1, J-STD-020C

Physical Specifications

Lead Material	Tin-plated copper
Soldering Characteristics	Solderability per MIL-STD-202, Method 208E
Insulating Material	Cured, flame retardant epoxy polymer meets UL94V-0 requirements.

HVR 250P Series PTC Devices

Tape and Reel Specifications: EIA-468-B/IEC60286-2

Dimension Description	EIA Mark	IEC Mark	Dimensions	
			Dim.(mm)	Tol.(mm)
Carrier tape width	W	W	18	-0.5/+1.0
Hold down tape width	W ₄	W ₀	11	min.
Top distance between tape edges	W ₆	W ₂	3	max.
Sprocket hole position	W ₅	W ₁	9	-0.5+0.75
Sprocket hole diameter*	D ₀	D ₀	4	-0.32/+0.2
Abscissa to plane(straight lead)	H	H	18.5	±3.0
Abscissa to plane(kinked lead)	H ₀	H ₀	16	±0.5
Abscissa to top	H ₁	H ₁	32.2	max.
Overall width without lead protrusion	C ₁		42.5	max.
Overall width with lead protrusion	C ₂		43.2	max.
Lead protrusion	L ₁	l ₁	1.0	max.
Protrusion of cut out	L	L	11	max.
Protrusion beyond hold-down tape	l ₂	l ₂	Not specified	
Sprocket hole pitch:P080CF-P145CF	P ₀	P ₀	12.7	±0.3
Sprocket hole pitch:P180CF	P ₀	P ₀	25.4	±0.5
Pitch tolerance			20 consecutive.	±1
Device pitch:P080CF-P145CF			12.7	
Device pitch:P180CF			25.4	
Tape thickness	t	t	0.9	max.
Tape thickness with splice	t ₁		2.0	max.
Splice sprocket hole alignment			0	±0.3
Body lateral deviation	Δh	Δh	0	±1.0
Body tape plane deviation	Δp	Δp	0	±1.3
Ordinate to adjacent component lead*	P ₁	P ₁	3.81	±0.7
Lead spacing	F	F	5.08	±0.8
Reel width	w ₂	w	56	max.
Reel diameter	a	d	370	max.
Space between flanges less device*	w ₁		4.75	-3.25/+9.25
Arbor hole diameter	c	f	26	±12.0
Core diameter*	n	h	91	max.
Box			56/372/372	max.
Consecutive missing places			None	
Empty places per reel			0.1%max.	

*Differs from EIA specification.

HVR 250P Series PTC Devices

Tape and Reel Specifications: EIA-468-B/IEC60286-2

(Continued)

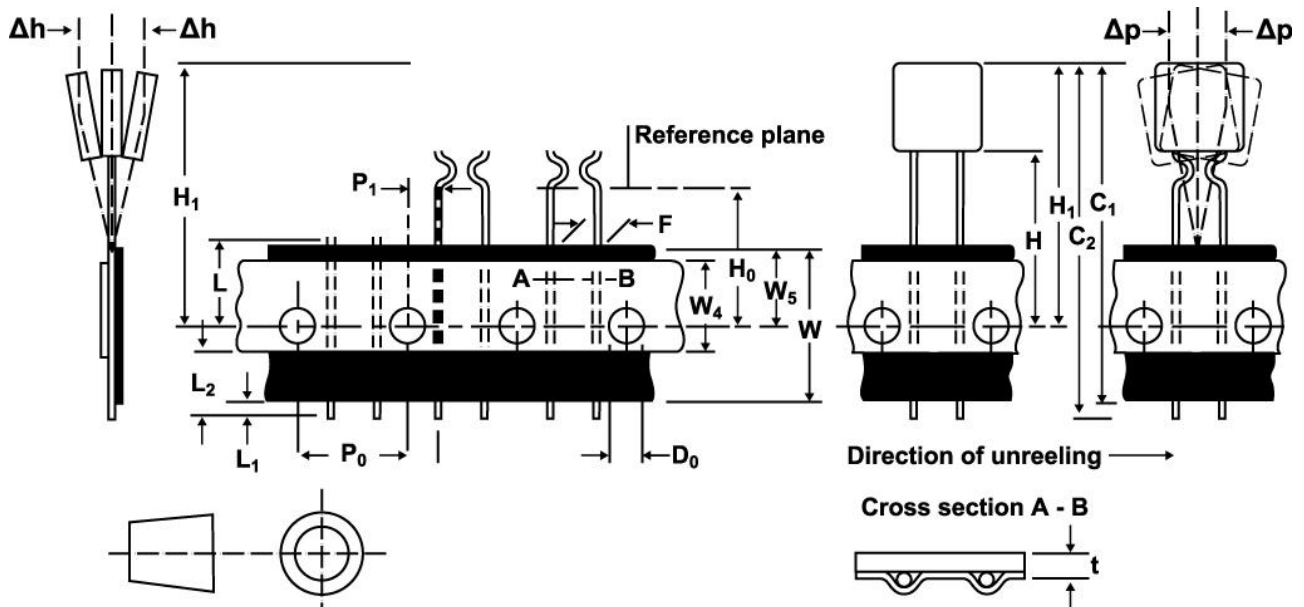

Fig. 1

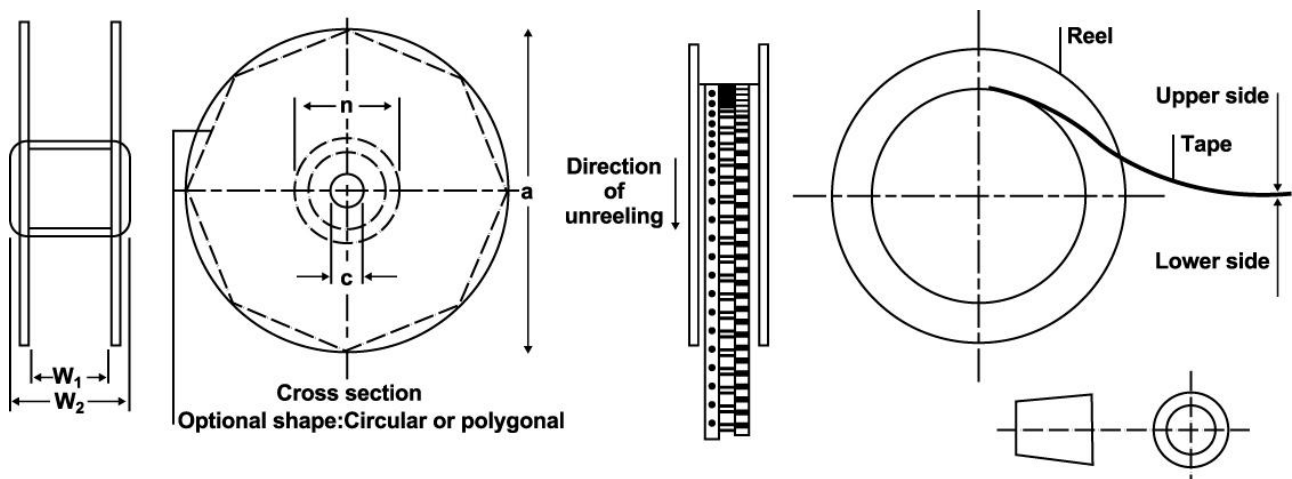
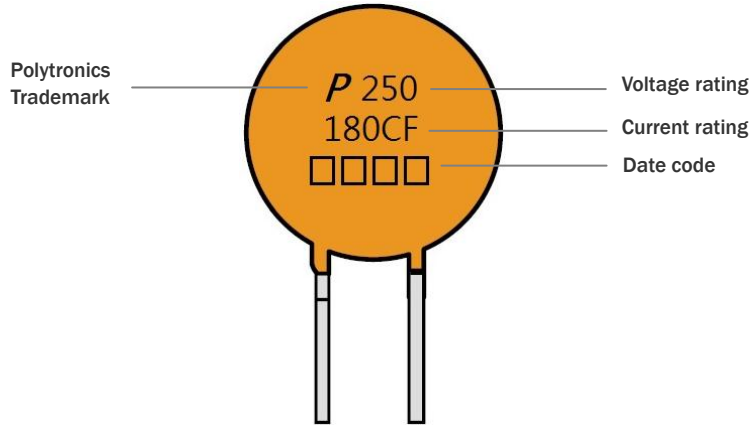

Fig. 2

HVR 250P Series PTC Devices

Marking on Device



Part Ordering Number System

HVR 250 P □□□ **CF** - □□

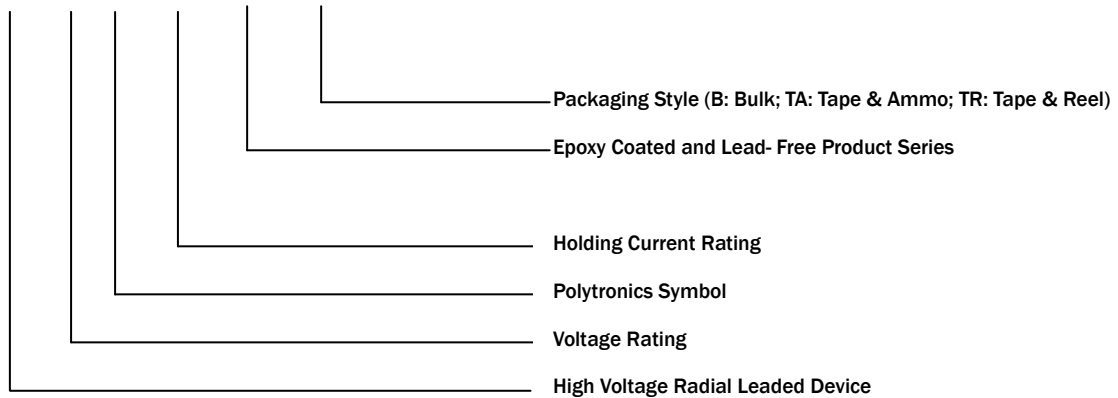

HVR 250P Series PTC Devices

Packaging Quantity

Part Number	Ordering Code	Bag Quantity	Reelpack Quantity	Ammopack Quantity
HVR250P080CF	HVR250P080CF-B	500		
	HVR250P080CF-TR		1200	
	HVR250P080CF-TA			1200
HVR250P120CF	HVR250P120CF-B	500		
	HVR250P120CF-TR		1200	
	HVR250P120CF-TA			1200
HVR250P145CF	HVR250P145CF-B	500		
	HVR250P145CF-TR		1200	
	HVR250P145CF-TA			1200
HVR250P180CF	HVR250P180CF-B	200		
	HVR250P180CF-TR		1000	
	HVR250P180CF-TA			1000

X-ON Electronics

Largest Supplier of Electrical and Electronic Components

Click to view similar products for [Resettable Fuses - PPTC](#) category:

Click to view products by [Polytronics](#) manufacturer:

Other Similar products are found below :

[RF0077-000](#) [RF0627-000](#) [RF3301-000](#) [RF3382-000](#) [SMD125-2](#) [RF1973-000](#) [RF2531-000](#) [RF2873-000](#) [RF3060-000](#) [TR600-150Q-B-0.5-0.130](#) [RXE090](#) [5E4795/04-1502](#) [TRF250-080T-B-1.0-0.125](#) [SMD100-2](#) [NIS5431MT1TXG](#) [SMD250-2](#) [RS30-090](#) [RS30-600](#) [RS30-800](#) [RS30-900](#) [RS60RB-160](#) [RS60SB-250](#) [SB250-145](#) [0ZCH0110AF2E](#) [0603L001/60YR](#) [0603L003/36YR](#) [BK250-120-SZ-E0.6](#) [BK60-010-DI-E0.5](#) [BK250-040-DY-E0.6](#) [RF2631-000](#) [NIS5420MT2TXG](#) [NIS5420MT3TXG](#) [NIS6420MT1TWG](#) [RF5032-000](#) [RF5051-000](#) [RF5034-000](#) [RF5105-000](#) [RF5062-000](#) [RF5055-000](#) [RF5052-000](#) [2920L075/72MR](#) [BSMD0603-025-24V](#) [BSMD0402L-005](#) [BSMD0603-010-9V](#) [BSMD1812-020-60V](#) [BSMD2920-400-30V](#) [BSMD0603-010-12V](#) [BSMD0805-035-30V](#) [BSMD1210-150-16V](#) [BSMD0805-003-60V](#)