

**PRODUCT
DATASHEET**



LVD Series PTC Devices

LVD Series PTC Devices

Description

The LVD series provides radial leaded resettable over-current protection with holding current from 0.05A to 2.0A. This series is suitable for wide range of applications in modern appliances, line voltage power supply, and transformers

Features





- RoHS compliant and lead-free
- Halogen-free
- Compact design saves board space
- Low resistance
- Fast response to fault current

Applications

- Electromagnetic loads
- Industrial controls
- Appliances
- Medical equipments
- Transformers
- Motors, fans and blowers





Agency Approval and Environmental Compliance

Agency	File Number	Regulation	Standard
	E201431		2011/65/EU
	R50103297		IEC 61249-2-21:2003

LVD Series PTC Devices

Electrical Characteristics

Part Number	I _{hold} (A)	I _{trip} (A)	V _{max}		I _{max} Interrupt (A)	P _{d typ} (W)	Maximum Time To Trip		Resistance		Agency Approval	
			Operating	Interrupt			Current (A)	Time (Sec.)	R _{min} (Ω)	R _{1max} (Ω)		
LVD005	0.05	0.12	240	265	1.0	0.9	0.25	10.0	17.5	65.0	✓	✓
			120	135	20.0							
LVD008	0.08	0.19	240	265	1.2	0.9	0.40	10.0	7.40	26.0	✓	✓
			120	135	20.0							
LVD012	0.12	0.30	240	265	1.2	1.0	0.60	15.0	3.00	12.0	✓	✓
			120	135	20.0							
LVD016	0.16	0.37	240	265	2.0	1.4	0.80	15.0	2.50	7.80	✓	✓
			120	135	20.0							
LVD025	0.25	0.56	240	265	3.5	1.5	1.25	18.5	1.30	3.80	✓	✓
			120	135	20.0							
LVD033	0.33	0.74	240	265	4.5	1.7	1.65	21.0	0.77	2.60	✓	✓
			120	135	20.0							
LVD040	0.40	0.90	240	265	5.5	2.0	2.00	24.0	0.60	1.90	✓	✓
			120	135	20.0							
LVD055	0.55	1.25	240	265	7.0	3.4	2.75	26.0	0.45	1.45	✓	✓
			120	135	20.0							
LVD075	0.75	1.50	240	265	7.5	2.6	3.75	18.0	0.32	0.84	✓	✓
			120	135	20.0							
LVD100	1.00	2.00	240	265	10.0	2.9	5.00	21.0	0.22	0.58	✓	✓
			120	135	20.0							
LVD125	1.25	2.50	240	265	12.5	3.3	6.25	23.0	0.17	0.44	✓	✓
			120	135	20.0							
LVD200	2.00	4.00	240	265	20.0	4.5	10.0	28.0	0.09	0.22	✓	✓
			120	135	20.0							

Note on Electrical Characteristics

■ Vocabulary

I_{hold} = Hold current: maximum current device will pass without tripping in 25±2°C still air.

I_{trip} = Trip current: minimum current at which the device will trip in 25±2°C still air.

V_{max} = Maximum voltage device can withstand without damage at rated current (I_{max})

I_{max} = Maximum fault current device can withstand without damage at rated voltage (V_{max})

P_{d typ} = Typical power dissipated from device when in the tripped state at 25±2°C still air.

R_{min} = Minimum resistance of device in initial (un-soldered) state.

R_{1max} = Maximum resistance of device at 25±2°C measured one hour after tripping or reflow soldering of 260°C for 20 sec.

■ **Caution: Operation beyond the specified rating may result in damage and possible arcing and flame.**

■ **Specifications are subject to change without notice.**

LVD Series PTC Devices

Polymeric PTC Selecting Guide

- Determine the following operating parameters for the circuits:
 - Normal operating current (I_{hold})
 - Maximum interrupt current (I_{max})
 - Maximum circuit voltage (V_{max})
 - Normal operating temperature surrounding device (min°C/max°C)
- Select the device form factor and dimension suitable for the application:
 - Surface Mount Device (SMD)
 - Axial Leaded Device (ALD)
 - Other Customized Form Factors
 - Radial Leaded Device (RLD)
 - DISC Device
- Compare the maximum rating for V_{max} and I_{max} of the PPTC device with the circuit in application and make sure the circuit's requirement does not exceed the device rating.
- Check that PPTC device's trip time (time-to-trip) will protect the circuit.
- Verify that the circuit operating temperature is within the PPTC device's normal operating temperature range.
- Verify the performance and suitability of the chosen PPTC device in the application.

WARNING

- **Mechanical Stress**
 - PPTC devices will undergo a thermal expansion during fault condition. If PPTC devices are installed or placed in an application where the space between PPTC devices and the surrounding materials (e.g., covering materials, packaging materials, encapsulate materials and the like) is insufficient, it will cause an inhibiting effect upon the thermal expansion. Pressing, twisting, bending and other kinds of mechanical stress will also adversely affect the performance of the PPTC devices, and shall not be used or applied.
- **Chemical Pollutants**
 - Silicone-based oils, oils, solvents, gels, electrolytes, fuels, acids, and the like will adversely affect the properties of PPTC devices, and shall not be used or applied.
- **Electronic and Thermal Effect**
 - PPTC devices are secondary protection devices and are used solely for sporadic, accidental over-current or over-temperature error condition, and shall NOT be used if or when constant or repeated fault conditions (such fault conditions may be caused by, among others, incorrect pin-connection of a connector) or over-extensive trip events may occur.
 - PPTC devices are different from fuses and, when a fault condition occurs, will go into high-resistance state and do not open circuit, in which case the voltage at such PPTC devices may reach a hazardous level.
 - Operation over the maximum rating or other forms of improper use may cause failure, arcing, flame and/or other damage to the PPTC devices.
 - Conductive material contamination, such as metal particle, may induce shortage, flame or arcing.
 - Due to the inductance, the operation circuits may generate a circuit voltage (Ldi/dt) above the rated voltage of PPTC devices, which shall not be used under such circumstances.
- **General**
 - Customers shall evaluate and test the properties of PPTC devices independently to verify and ensure that their individual applications will be met.
 - The performance of PPTC devices will be adversely affected if they are improperly used under electronic, thermal and/or mechanical procedures and/or conditions non-conformant to those recommended by manufacturer.
 - Customers shall be responsible for determining whether it is necessary to have back-up, failsafe and/or fool-proof protection to avoid or minimize damage that may result from extra-ordinary, irregular function or failure of PPTC devices.
 - Any and all responsibilities and liabilities are disclaimed if any item under this notice of warning is not complied with.

LVD Series PTC Devices

Average Time-to-Trip Curves

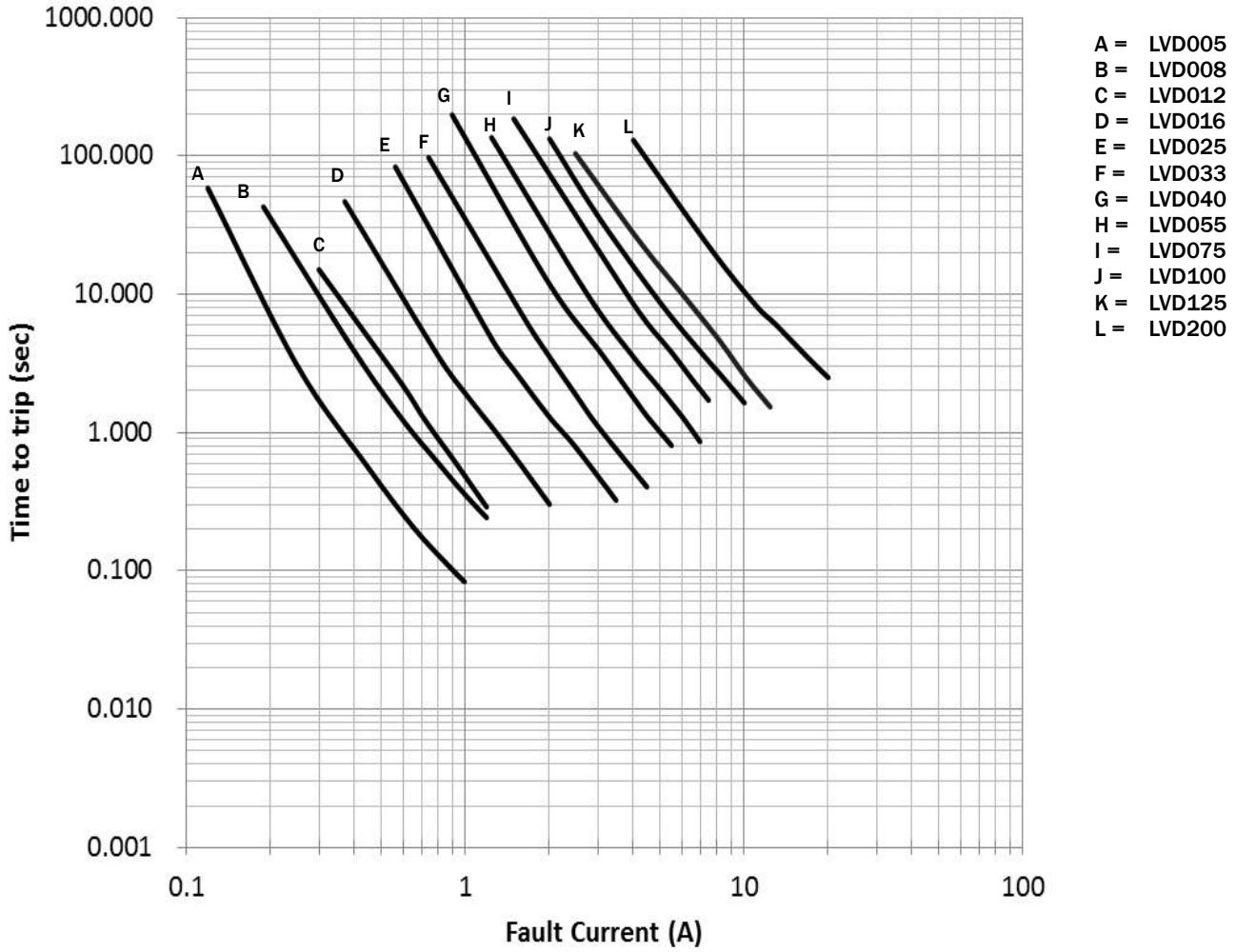

LVD Series PTC Devices

Thermal Derating Curve

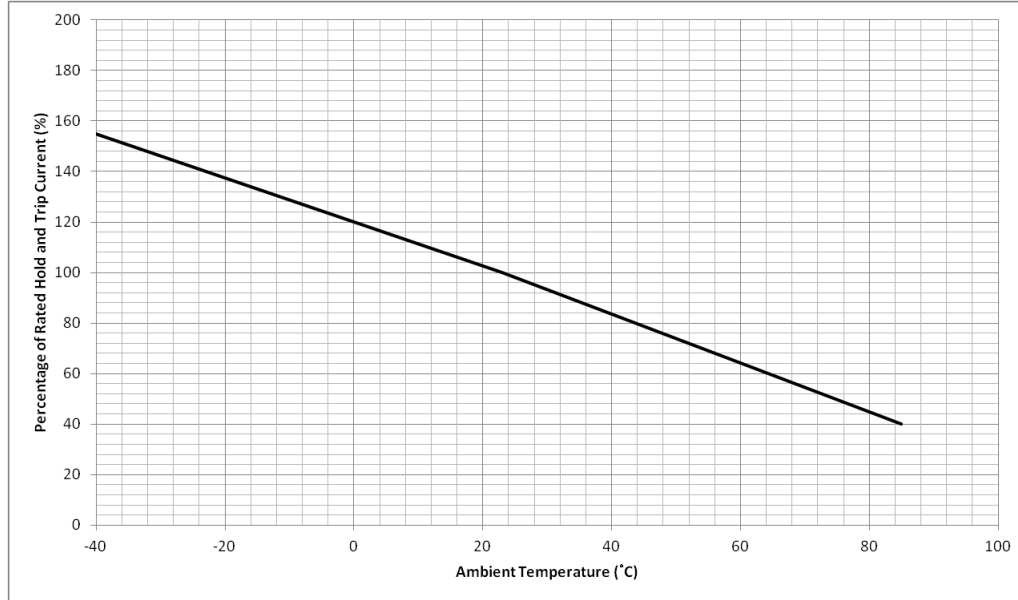

Thermal Derating Table

Recommended Hold Current (A) vs. Ambient Temperature (°C)

Part Number	Ambient Operation Temperature								
	-40 °C	-20 °C	0 °C	23 °C	40 °C	50 °C	60 °C	70 °C	85 °C
LVD005	0.08	0.07	0.06	0.05	0.04	0.04	0.03	0.03	0.02
LVD008	0.12	0.11	0.10	0.08	0.07	0.06	0.05	0.05	0.04
LVD012	0.18	0.16	0.14	0.12	0.10	0.09	0.08	0.07	0.06
LVD016	0.25	0.22	0.19	0.16	0.14	0.12	0.11	0.09	0.07
LVD025	0.39	0.34	0.30	0.25	0.21	0.19	0.17	0.15	0.12
LVD033	0.51	0.45	0.40	0.33	0.28	0.25	0.22	0.19	0.15
LVD040	0.62	0.55	0.48	0.40	0.34	0.31	0.27	0.24	0.18
LVD055	0.85	0.75	0.66	0.55	0.47	0.42	0.37	0.32	0.25
LVD075	1.16	1.03	0.90	0.75	0.64	0.57	0.51	0.44	0.35
LVD100	1.54	1.37	1.20	1.00	0.85	0.76	0.68	0.59	0.46
LVD125	1.93	1.71	1.50	1.25	1.06	0.96	0.85	0.74	0.58
LVD200	3.08	2.74	2.39	2.00	1.70	1.53	1.36	1.18	0.92

LVD Series PTC Devices

Physical Dimensions (mm.)

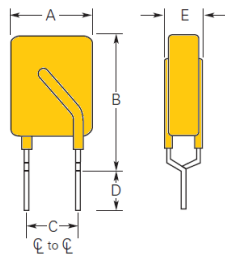

Fig. 1

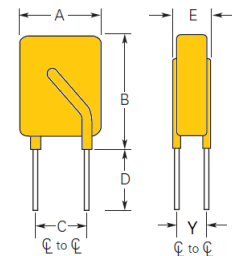

Fig. 2

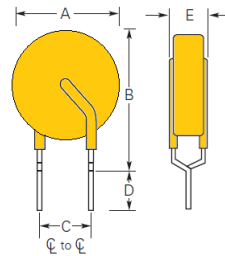

Fig. 3

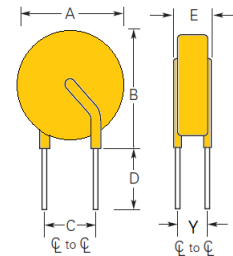
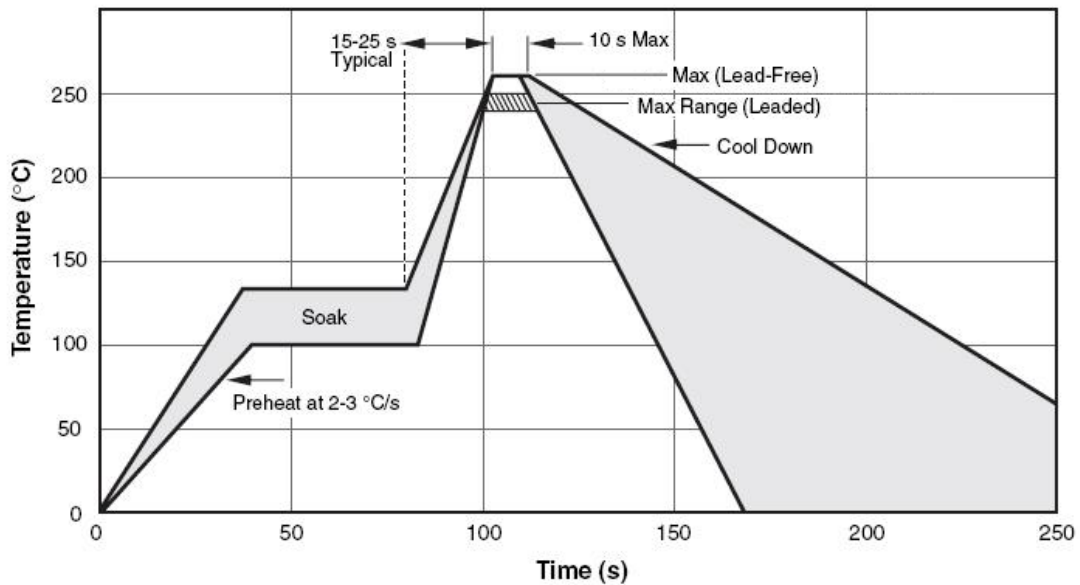

Fig. 4

Part Number	A	B	C	D	E	Y	Fig.	Lead Dia.
	Max.	Max.	Typ.	Min.	Max.	Typ.		
LVD005K	7.3	12.30	5.1±0.7	7.6	3.8	1.6	3	0.51
LVD005S	7.3	8.30	5.1±0.7	7.6	3.8	1.6	4	0.51
LVD008K	7.3	12.30	5.1±0.7	7.6	3.8	1.6	3	0.51
LVD008S	7.3	8.30	5.1±0.7	7.6	3.8	1.6	4	0.51
LVD012K	7.3	12.30	5.1±0.7	7.6	3.8	1.6	3	0.51
LVD012S	7.3	8.30	5.1±0.7	7.6	3.8	1.6	4	0.51
LVD016K	7.50	12.50	5.1±0.7	7.6	3.8	1.6	3	0.51
LVD016S	7.50	9.50	5.1±0.7	7.6	3.8	1.6	4	0.51
LVD025K	7.10	15.50	5.1±0.7	7.6	3.8	1.8	1	0.65
LVD025S	7.10	12.00	5.1±0.7	7.6	3.8	1.8	2	0.65
LVD033K	9.60	16.30	5.1±0.7	7.6	3.8	1.8	1	0.65
LVD033S	9.60	13.27	5.1±0.7	7.6	3.8	1.8	2	0.65
LVD040K	10.50	17.20	5.1±0.7	7.6	3.8	1.8	1	0.65
LVD040S	10.50	14.16	5.1±0.7	7.6	3.8	1.8	2	0.65
LVD055K	11.60	19.50	5.1±0.7	7.6	4.1	1.9	1	0.81
LVD055S	11.60	16.50	5.1±0.7	7.6	4.1	1.9	2	0.81
LVD075K	12.20	23.50	5.1±0.7	5.1	4.1	1.9	1	0.81
LVD075S	12.20	20.50	5.1±0.7	5.1	4.1	1.9	2	0.81
LVD100K	14.70	26.10	10.2±1.0	5.1	4.1	1.9	1	0.81
LVD100S	14.70	23.05	10.2±1.0	5.1	4.1	1.9	2	0.81
LVD125K	18.00	28.00	10.2±1.0	5.1	4.1	1.9	1	0.81
LVD125S	18.00	25.00	10.2±1.0	5.1	4.1	1.9	2	0.81
LVD200K	24.80	32.50	10.2±1.0	5.1	4.1	1.9	1	0.81
LVD200S	24.80	27.30	10.2±1.0	5.1	4.1	1.9	2	0.81

LVD Series PTC Devices

Wave Soldering Parameters



Profile Feature	Pb-Free Assembly
Average Ramp-Up Rate ($T_{s_{max}}$ to T_P)	4°C/second max.
Preheat	
-Temperature Min ($T_{s_{min}}$)	100°C
-Temperature Max ($T_{s_{max}}$)	125°C
-Time ($T_{s_{min}}$ to $T_{s_{max}}$)	60-180 seconds
Peak Temperature (T_P)	265°C
Max Time at Peak Temperature (t_p)	5 seconds
Ramp-Down Rate	6°C /second max.
Time 25°C to Peak Temperature	5 minutes max.
Storage Condition	0°C ~35°C, ≤ 80%RH

Note: If the wave soldering temperatures exceed the recommended profile, devices may not meet the performance requirements.

LVD Series PTC Devices

Environmental Specifications

Operating Temperature	-40°C to +85 °C
Maximum Device Surface Temperature in Tripped State	125°C
Passive Aging	+85°C , 1000 hours ±10% typical resistance change for LVD012~LVD200 -30% typical resistance change for LVD005~LVD008
Humidity Aging	+85°C , 85%R.H. 1000 hours ±10% typical resistance change for LVD012~LVD200 -30% typical resistance change for LVD005~LVD008
Thermal Shock	MIL-STD-202 Method 107G +85°C /-40°C 10 times -30% typical resistance change
Solvent Resistance	MIL-STD-202, Method 215 No change
Vibration	MIL-STD-883C, Method 2007.1, Condition A No change
Moisture Sensitivity Level	Level 1, J-STD-020C

Physical Specifications

Lead Material	Tin-plated copper
Soldering Characteristics	Solderability per MIL-STD-202, Method 208E
Insulating Material	Cured, flame retardant epoxy polymer meets UL94V-0 requirements.

LVD Series PTC Devices

Tape and Reel Specifications: EIA468-B/IEC60286-2

Dimension Description	EIA Mark	IEC Mark	Dimensions	
			Dim.(mm)	Tol.(mm)
Carrier tape width	W	W	18	-0.5/+1.0
Hold down tape width	W ₄	W ₀	11	min.
Top distance between tape edges	W ₆	W ₂	3	max.
Sprocket hole position	W ₅	W ₁	9	-0.5+0.75
Sprocket hole diameter*	D ₀	D ₀	4	-0.32/+0.2
Abscissa to plane(straight lead)	H	H	18.5	+3.0
Abscissa to plane(kinked lead)	H ₀	H ₀	16	+0.5
Abscissa to top LVD005-LVD016	H ₁	H ₁	32.2	max.
Abscissa to top LVD025-LVD200	H ₁		47.5	max.
Overall width without lead protrusion: LVD005-LVD016	C ₁		42.5	max.
Overall width without lead protrusion: LVD025-LVD200			57	
Overall width with lead protrusion: LVD005-LVD016	C ₂		43.2	max.
Overall width with lead protrusion: LVD025-LVD200			58	
Lead protrusion	L ₁	l ₁	1.0	max.
Protrusion of cut out	L	L	11	max.
Protrusion beyond hold-down tape	l ₂	l ₂	Not specified	
Sprocket hole pitch: LVD005-LVD075	P ₀	P ₀	12.7	+0.3
Sprocket hole pitch: LVD100-LVD200	P ₀	P ₀	25.4	+0.5
Pitch tolerance			20 consecutive. +1	
Device pitch: LVD005-LVD075			12.7	
Device pitch: LVD100-LVD200			25.4	
Tape thickness	t	t	0.9	max.
Tape thickness with splice	t ₁		2.0	max.
Splice sprocket hole alignment			0	+0.3
Body lateral deviation	Δh	Δh	0	+1.0
Body tape plane deviation	Δp	Δp	0	+1.3
Ordinate to adjacent component lead*: LVD005-LVD075	P ₁	P ₁	3.81	+0.7
Ordinate to adjacent component lead*: LVD100-LVD200			7.62	+0.7
Lead spacing: LVD005-LVD075	F	F	5.08	+0.8
Lead spacing: LVD100-LVD200	F	F	10.18	+0.8
Reel width LVD005-LVD016	w ₂	w	56	max.
Reel width LVD025-LVD200	w ₂	w	63.5	max.
Reel diameter	a	d	370	max.
Space between flanges less device*	w ₁		4.75	-3.25/+9.25
Arbor hole diameter	c	f	26	+12.0
Core diameter*	n	h	91	max.
Box			56/372/372	max.
Consecutive missing places			None	
Empty places per reel			0.1%max.	

LVD Series PTC Devices

Tape and Reel Specifications: EIA468-B/IEC60286-2

(Continued)

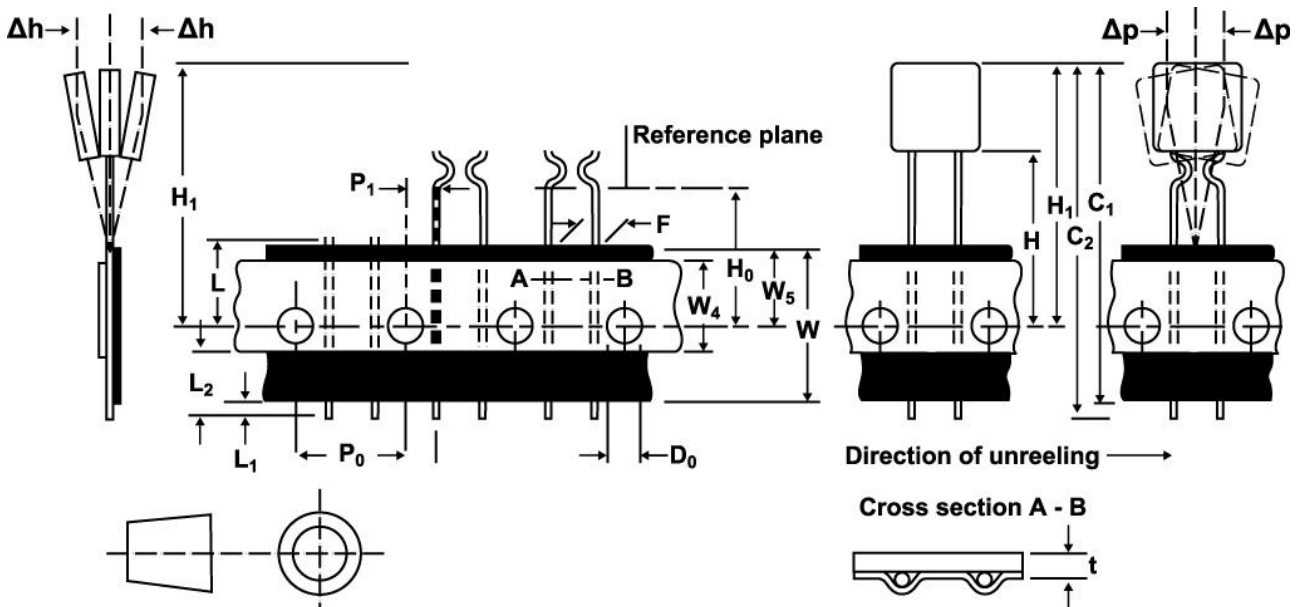

Fig. 1

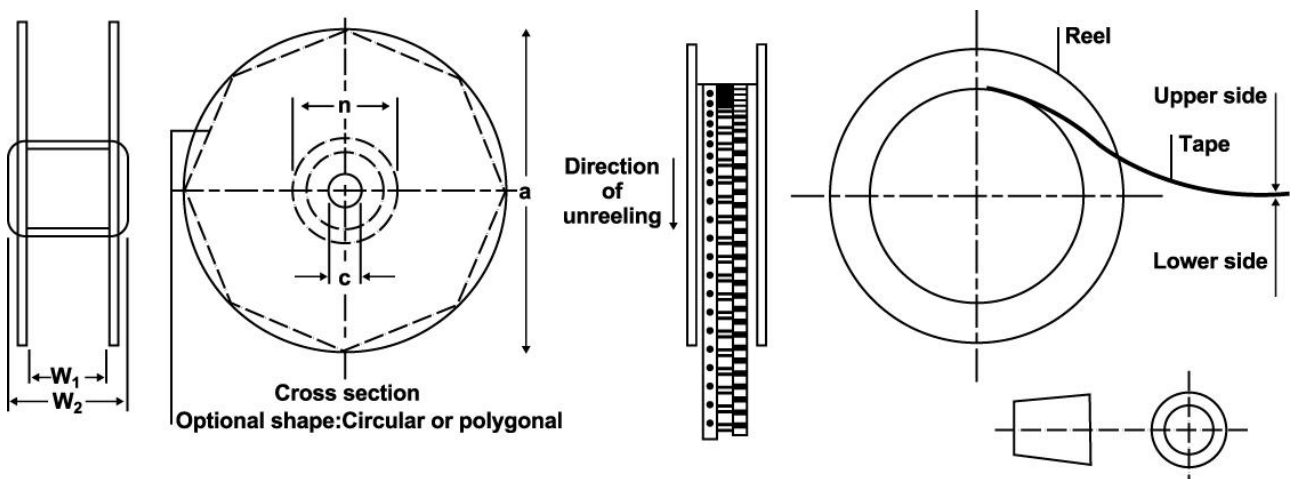
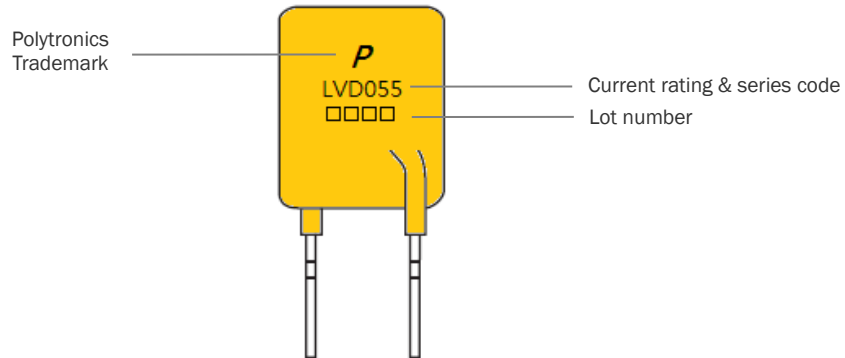

Fig. 2

LVD Series PTC Devices

Marking on Device



Part Ordering Number System

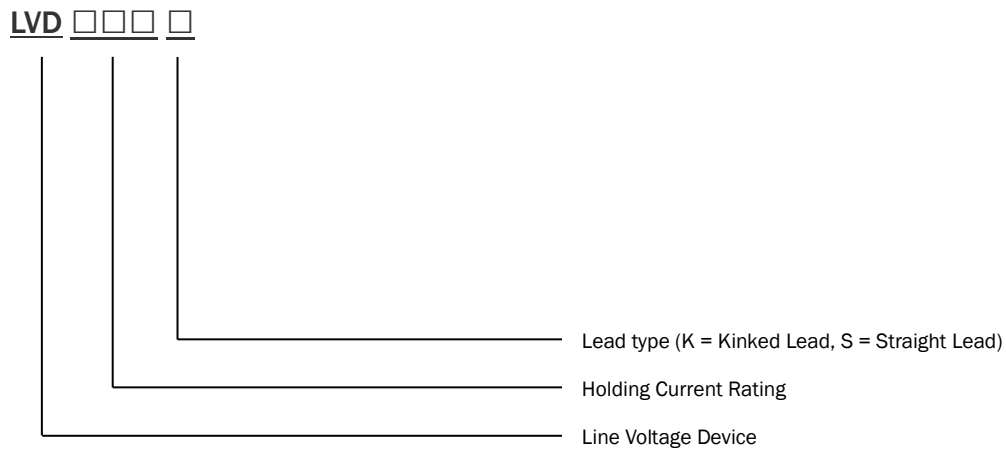

LVD Series PTC Devices

Packaging Quantity

Part Number	Ordering Code	Bag Quantity	Reelpack Quantity	Ammopack Quantity
LVD005	LVD005-B	500		
	LVD005-TR		1500	
	LVD005-TA			1500
LVD008	LVD008-B	500		
	LVD008-TR		1500	
	LVD008-TA			1500
LVD012	LVD012-B	500		
	LVD012-TR		1500	
	LVD012-TA			1500
LVD016	LVD016-B	500		
	LVD016-TR		1500	
	LVD016-TA			1500
LVD025	LVD025-B	500		
	LVD025-TR		1500	
	LVD025-TA			1500
LVD033	LVD033-B	500		
	LVD033-TR		1500	
	LVD033-TA			1500
LVD040	LVD040-B	500		
	LVD040-TR		1500	
	LVD040-TA			1500
LVD055	LVD055-B	500		
	LVD055-TR		1500	
	LVD055-TA			1500
LVD075	LVD075-B	200		
	LVD075-TR		1000	
	LVD075-TA			1000
LVD100	LVD100-B	200		
	LVD100-TR		1000	
	LVD100-TA			1000
LVD125	LVD125-B	200		
	LVD125-TR		1000	
	LVD125-TA			1000
LVD200	LVD200-B	100		
	LVD200-TR		1000	
	LVD200-TA			1000

X-ON Electronics

Largest Supplier of Electrical and Electronic Components

Click to view similar products for [Resettable Fuses - PPTC](#) category:

Click to view products by [Polytronics](#) manufacturer:

Other Similar products are found below :

[RF0077-000](#) [RF0627-000](#) [RF3301-000](#) [RF3382-000](#) [SMD125-2](#) [RF1973-000](#) [RF2531-000](#) [RF2873-000](#) [RF3060-000](#) [TR600-150Q-B-0.5-0.130](#) [RXE090](#) [5E4795/04-1502](#) [TRF250-080T-B-1.0-0.125](#) [SMD100-2](#) [NIS5431MT1TXG](#) [SMD250-2](#) [RS30-090](#) [RS30-600](#) [RS30-800](#) [RS30-900](#) [RS60RB-160](#) [RS60SB-250](#) [SB250-145](#) [OZCH0110AF2E](#) [0603L001/60YR](#) [0603L003/36YR](#) [BK250-120-SZ-E0.6](#) [BK60-010-DI-E0.5](#) [BK250-040-DY-E0.6](#) [RF2631-000](#) [NIS5420MT2TXG](#) [NIS5420MT3TXG](#) [NIS6420MT1TWG](#) [RF5032-000](#) [RF5051-000](#) [RF5034-000](#) [RF5105-000](#) [RF5062-000](#) [RF5055-000](#) [RF5052-000](#) [2920L075/72MR](#) [BSMD0603-025-24V](#) [BSMD0402L-005](#) [BSMD0603-010-9V](#) [BSMD1812-020-60V](#) [BSMD2920-400-30V](#) [BSMD0603-010-12V](#) [BSMD0805-035-30V](#) [BSMD1210-150-16V](#) [BSMD0805-003-60V](#)