

**Model 6729**  
**Do-It-Yourself Right-Angle Sheath Banana Plug**

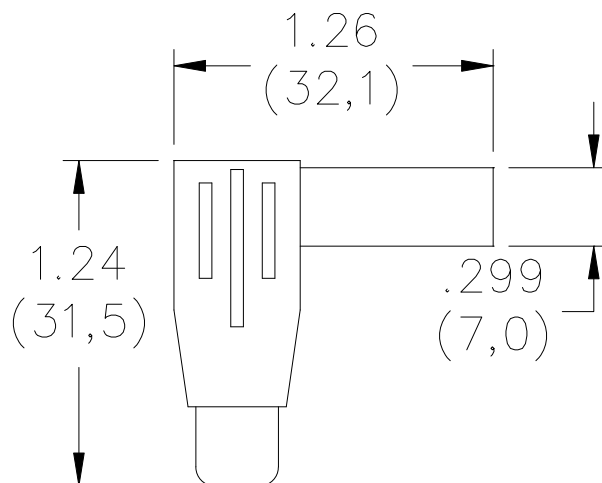

**Features**

- Fits standard banana safety-style jacks.
- Fits DMM with safety-style banana jacks.
- Simple assembly.
- Complies with International Safety Standard IEC 61010-2-031.
- Accepts 18 AWG test lead wire (e.g. Pomona model: 6733 or 6734).

**Materials**

Banana Jack:	Nickel Plated Brass
Banana Plug:	Nickel Plated Beryllium Copper
Insulation:	Lucel Acetal Polymer

**Materials**

Voltage / Current:	* 1000 Vrms, CAT III, 20 A, IEC 61010-2-031
Temperature:	-10°C to +55°C

**Ordering Information**

6729-0	Black, Do-It-Yourself Right-Angle Sheath Banana Plug
6729-2	Red, Do-It-Yourself Right-Angle Sheath Banana Plug

*\* When plug is correctly assembled and terminated.*

**USA:** Sales: 800-490-2361  
 Technical Support: [technicalsupport@pomonatest.com](mailto:technicalsupport@pomonatest.com)  
 Fax: 425-446-5844  
**Europe:** 31-(0) 40 2675 150 **International:** 425-446-5500  
**Where to Buy:** [www.pomonaelectronics.com](http://www.pomonaelectronics.com)

All dimensions are in inches. Tolerances (except noted): .xx = ±.02" (.51 mm), .xxx = ±.005" (.127 mm). All specifications are to the latest revisions. Specifications are subject to change without notice. Registered trademarks are the property of their respective companies.

**Model 6729**  
**Do-It-Yourself Right-Angle Sheath Banana Plug**

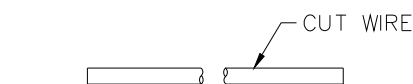

1. CUT WIRE TO LENGTH.

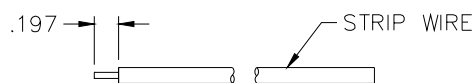

2. STRIP WIRE TO DIMENSION SHOWN.

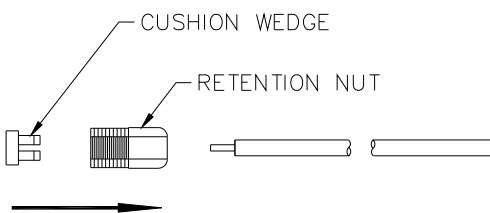

3. SLIDE RETENTION NUT OVER WIRE.  
SLIDE CUSHION WEDGE OVER WIRE.



4. SOLDER TIP TO WIRE IN LOCATION SHOWN.

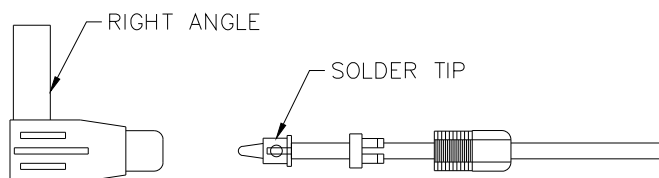
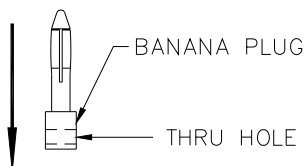

5. SLIDE BANANA PLUG INTO RIGHT ANGLE  
WITH THRU HOLE FACING SOLDER TIP.

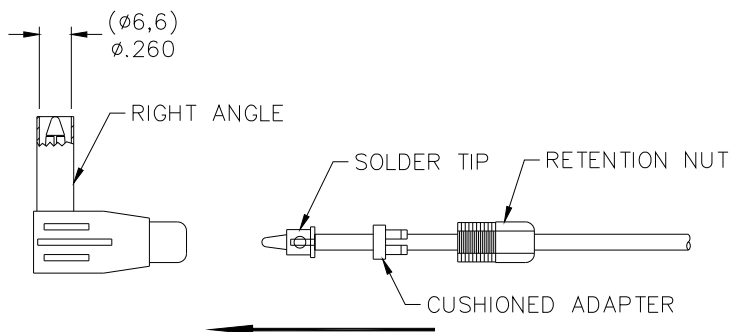

6. ASSEMBLE SOLDER TIP AND CUSHIONED ADAPTER. ALINE THE BANANA PLUG THRU HOLE TO SOLDER TIP. THREAD BY SLIDING SOLDER TIP ASSEMBLY INTO BANANA PLUG THRU HOLE AND TIGHTEN RETENTION NUT TO RIGHT ANGLE.

CHECK FOR CONTINUITY.

**USA:** Sales: 800-490-2361  
Technical Support: [technicalsupport@pomonatest.com](mailto:technicalsupport@pomonatest.com)  
Fax: 425-446-5844  
**Europe:** 31-(0) 40 2675 150 **International:** 425-446-5500  
**Where to Buy:** [www.pomonaelectronics.com](http://www.pomonaelectronics.com)

All dimensions are in inches. Tolerances (except noted): .xx = ±.02" (.51 mm), .xxx = ±.005" (.127 mm). All specifications are to the latest revisions. Specifications are subject to change without notice. Registered trademarks are the property of their respective companies.

**Model 6729**  
**Do-It-Yourself Right-Angle Sheath Banana Plug**

Pomona®

The items included with this product are certified to meet IEC 1010-2-031 safety requirements.

Les éléments inclus avec ce produit sont certifiés pour répondre à des exigences de sûreté du IEC 1010-2-031.

Los items incluidos con este producto se certifican para resolver requisitos de seguridad del IEC 1010-2-031.

– Only IEC 1010 type shrouded test plugs should be used with IEC 1010 type jacks. NEVER INSERT A PROBE TIP WITH BANANA SPRING INTO A TEST ACCESSORY JACK THAT WILL BE USED AS A HAND HELD PROBING DEVICE

–Seuls les vérificateurs de tension renforcés de type IEC 1010 devraient être utilisés avec des jacks de type IEC 1010. NE JAMAIS INSERER DE BOUT DE SONDE AVEC RESSORT BANANE DANS UN JACK D'ESSAI D'ACCESSOIRES QUI SERA UTILISE COMME DISPOSITIF DE SONDAGE A MAIN.

–Se deben usar sólo tapones de prueba reforzados del tipo IEC 1010 con receptáculos de tipo IEC 1010. NUNCA INTRODUZCA UNA CLAVIJA CON UN MUELLE TIPO BANANA EN UN RECEPTACULO DE PRUEBA QUE A SU VEZ SE USE COMO APARATO DE PRUEBA MANUAL.



Both Direct and Alternating Current.  
Courant Continu et Alternatif.  
Corriente Directa y Alterna.



Double Insulation or Reinforced Insulation.  
Isolation Double ou Isolation Renforcée.  
Aislamiento Doble o Aislamiento Reforzado.

CAT

Overvoltage Category I, II, III or IV.  
Surtension Catégorie I, II, III ou IV.  
Sobretensión de Categoría I, II III o IV.



Caution ! Refer to Accompanying Documents.  
Attention ! Se Reporter aux Documents joints.  
; Peligro! Consulte los Documentos Adjuntos.



Caution ! Risk of Electric Shock.  
Attention ! Risque de Choc Électrique.  
; Peligro! Riesgo de Sacudida Eléctrica.

Pomona Electronics 

PO Box 9090, Everett, WA 98206-9090 TEL: 800-490-2361

**USA:** Sales: 800-490-2361  
Technical Support: [technicalsupport@pomonatest.com](mailto:technicalsupport@pomonatest.com)  
Fax: 425-446-5844  
**Europe:** 31-(0) 40 2675 150 **International:** 425-446-5500  
**Where to Buy:** [www.pomonaelectronics.com](http://www.pomonaelectronics.com)

All dimensions are in inches. Tolerances (except noted): .xx = ±.02" (.51 mm), .xxx = ±.005" (.127 mm). All specifications are to the latest revisions. Specifications are subject to change without notice. Registered trademarks are the property of their respective companies.

## X-ON Electronics

Largest Supplier of Electrical and Electronic Components

*Click to view similar products for [Test Plugs & Test Jacks](#) category:*

*Click to view products by [Pomona](#) manufacturer:*

Other Similar products are found below :

[01-2601-4-0210](#) [01-2601-4-0212](#) [01-2604-4-0212](#) [01-2604-5-0210](#) [01-2150-1-0312](#) [01-2350-1-02](#) [01-2352-1-02](#) [01-2368-1-02](#) [01-2604-4-0210](#) [01-2604-5-0212](#) [01-2606-4-0210](#) [01-2606-4-0212](#) [01-2606-5-0212](#) [M39024/10-01G](#) [M39024/10-17G](#) [M39024/11-09G](#) [M39024/11-42](#) [M39024/11-43](#) [M39024/12-08](#) [707-5311](#) [707-5402-01-19](#) [707-5410](#) [923739-40-I](#) [R644543000](#) [R948161000](#) [R999351000](#) [1408-4](#) [1499-101](#) [1533-1](#) [1659559](#) [1659567](#) [1663921](#) [1663939](#) [1696-102](#) [174-R825B-EX](#) [NYS508-BU](#) [NYS508-O](#) [211-101](#) [RS100GBL](#) [RS250GBL](#) [251-102](#) [25-2251-2-03](#) [25-2259-2-03](#) [923743-16-I](#) [923743-24-I](#) [923743-28-I](#) [2854-BLU](#) [2970-BLK](#) [30-443G](#) [1680](#)