

Model 73059

UHF Plug, Clamp Type, RG8, 9, 11, 63, 87A, 213, 214, 225

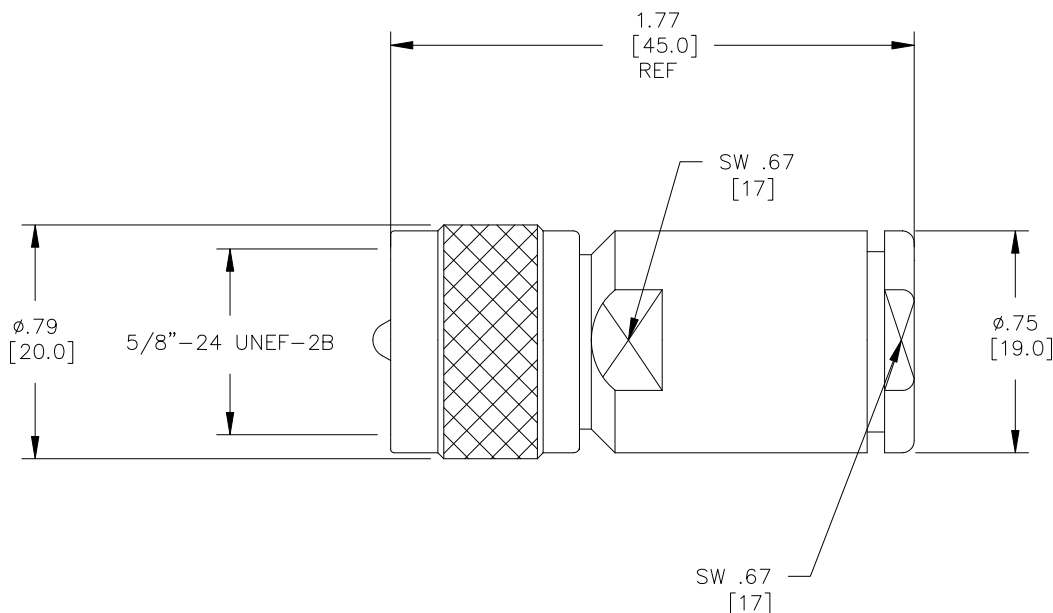

*Model 73059
UHF Plug, Clamp Type,
RG8, 9, 11, 63, 87A, 213, 214, 225*

Features

- DC – 300MHz bandwidth.
- Connectors are precision machined.
- Meets interface requirements MIL-C-39012.
- Connector accepts cable types RG/U: 8, 9, 11, 63, 87A, 213, 214, 225

Materials

Center Conductor, Male:
Phosphor Bronze, Gold Plated
Connector Body: Brass, Nickel Plated
Insulators: PTFE

Specifications

Frequency Range:	DC – 300MHz
Contact Resistance:	
Center Conductor:	≤1.0 mΩ
Outer Conductor:	≤0.2 mΩ
Insulation Resistance:	≥ 300 MΩ
Dielectric Withstand Voltage:	750V
	<i>For CE compliance, do not hold in hand when voltages exceed 33 Vrms / 70 Vdc.</i>
Number of Insertions:	500 cycles minimum

Ordering Information

Model: **73059**

USA: Sales: 800-490-2361
Technical Support: technicalsupport@pomonatest.com
Fax: 425-446-5844

Europe: 31-(0) 40 2675 150 **International:** 425-446-5500

Where to Buy: www.pomonaelectronics.com

All dimensions are in inches. Tolerances (except noted): .xx = ±.02" (.51 mm), .xxx = ± .005" (.127 mm). All specifications are to the latest revisions. Specifications are subject to change without notice. Registered trademarks are the property of their respective companies.

Model 73059

UHF Plug, Clamp Type, RG8, 9, 11, 63, 87A, 213, 214, 225

Cable Types

Connector Model #	Cable Groups
73059	RG8, 9, 11, 63, 87A, 213, 214, 225

Cable Assembly Instructions

1. CUT CABLE END EVENLY AND PERPENDICULAR

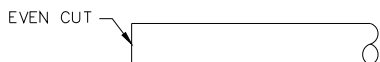

2. SLIDE NUT WASHERS AND FERRULE OVER CABLE AS SHOWN.

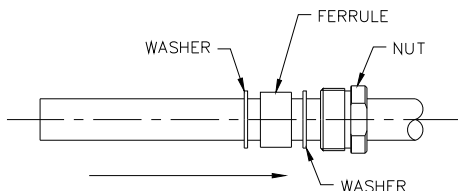

3. STRIP CABLE JACKET, BRAID AND DIELECTRIC TO SPECIFIC LENGTHS.

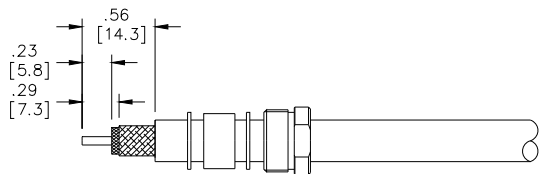

4. FLARE BRAID END SLIGHTLY.

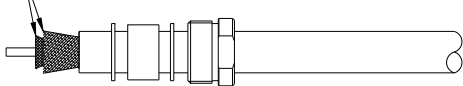

5. SLIDE BRAID CLAMP UNDER BRAID. SLIDE WASHER OVER CENTER CONDUCTOR. CRIMP CENTER CONTACT ONTO CENTER CONDUCTOR.

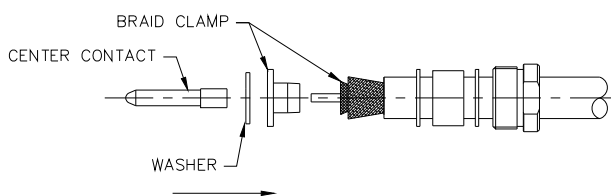

6. SLIDE FORWARD WASHERS FERRULE AND NUT OVER BRAID.

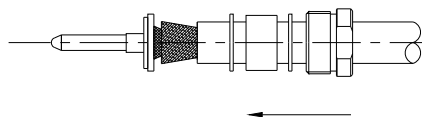

7. SLIDE CONNECTOR BODY OVER ASSEMBLY AND SCREW NUT.

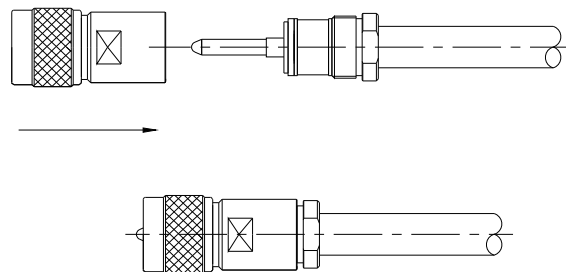

USA: Sales: 800-490-2361
 Technical Support: technicalsupport@pomonatest.com
 Fax: 425-446-5844
Europe: 31-(0) 40 2675 150 **International:** 425-446-5500
Where to Buy: www.pomonaelectronics.com

All dimensions are in inches. Tolerances (except noted): .xx = ±.02" (.51 mm), .xxx = ±.005" (.127 mm). All specifications are to the latest revisions. Specifications are subject to change without notice. Registered trademarks are the property of their respective companies.

X-ON Electronics

Largest Supplier of Electrical and Electronic Components

Click to view similar products for [RF Connectors / Coaxial Connectors](#) category:

Click to view products by [Pomona](#) manufacturer:

Other Similar products are found below :

[8915-1511-000](#) [89674-0827](#) [6001-7071-019](#) [6002-7051-003](#) [6002-7551-202](#) [6059674-1](#) [619550-1](#) [630059-000](#) [M39030/3-01N](#) [6500-7071-046](#) [6769](#) [CX050L2AQ](#) [7002-1542-011](#) [7004-1512-000](#) [7009-1511-004](#) [7010-1511-000](#) [7029-1511-060](#) [7101-1541-010](#) [7101-1571-002](#) [7105-1521-002](#) [7145-1521-002](#) [7203-1571-003](#) [7209-1511-011](#) [7210-1511-015](#) [7210-1511-019](#) [73137-5015](#) [73216-2241](#) [7325-1512-000](#) [73404-2300](#) [7405-1521-005](#) [7405-1521-802](#) [7406-1521-005](#) [8527](#) [8547](#) [FS11V](#) [8808-1511-001](#) [9049-9513-000](#) [9074-9513-000](#) [9101-9573-002](#) [910A205F](#) [9130-9573-002](#) [PL11SC-026](#) [PL375-33](#) [PL40-5](#) [PL71-9](#) [PL74C-221](#) [PL75MC-217](#) [PL803-7](#) [980-8666-005](#) [1200690078](#)