

POSB12200D series

12V / 2A Desktop type AC/DC adaptor



■ Features:

- Universal AC input / Full range
- ErP step II / CEC level VI compliance
- No load power consumption $P < 0.075W$
- Protections: Overload / Short circuit / Over Voltage



ELECTRICAL SPECIFICATION

MODEL	POSB 12200D
-------	-------------

OUTPUT

Rated Voltage	12V
Rated Current	2A
Current Range	0 ÷ 2A
Rated Power	24W
Line Regulation	± 2%
Load Regulation	± 5%
Tolerance	± 8%
Ripple & Noise (max.)	120mV _{p-p}
Setup, Rise Time	1000ms, 20ms / 230VAC at full load
Hold up Time (typ.)	50ms / 230VAC at full load

INPUT

Voltage Range	90 ÷ 264VAC
Frequency Range	47 ÷ 63Hz
Efficiency (typ.)	86.34%
AC Current (typ.)	0.5A / 230VAC
No load Power Consumption (max.)	0.075W

PROTECTIONS

Overload	Range: 140-170% Auto-recovery.
Short Circuit	Type: hiccup mode, auto-recovery.
Over Voltage	Type: auto-recovery.

POSB12200D series

12V / 2A Desktop type AC/DC adaptor



WORKING ENVIRONMENT

Working Temperature	0°C ÷ 40°C
Working Humidity	5 ÷ 90% RH non-condensing
Storage Temperature and Humidity	-20°C ÷ 85°C, 5 ÷ 90% RH non-condensing

SAFETY and EMC REGULATIONS

Safety Standards	Compliance to EN 60950-1
Withstand Voltage	IN/OUT: 3.6kVAC
Isolation Resistance	IN/OUT: 50MΩ/500VDC/25°C/70%
EMC Emission	Compliance to EN55032
EMC Immunity	Compliance to EN61000-4-2, -3, -4, -5
Harmonic Current	Compliance to EN61000-3-3; EN61000-3-2

OTHERS

DC wire and plug	Wire: 20AWG*2C, length = 1550mm	Plug: 2.1/5.5, positive inside
Net Weight / Dimensions	182g / 96 x 68 x 31mm (L x W x H)	

MECHANICAL SPECIFICATION

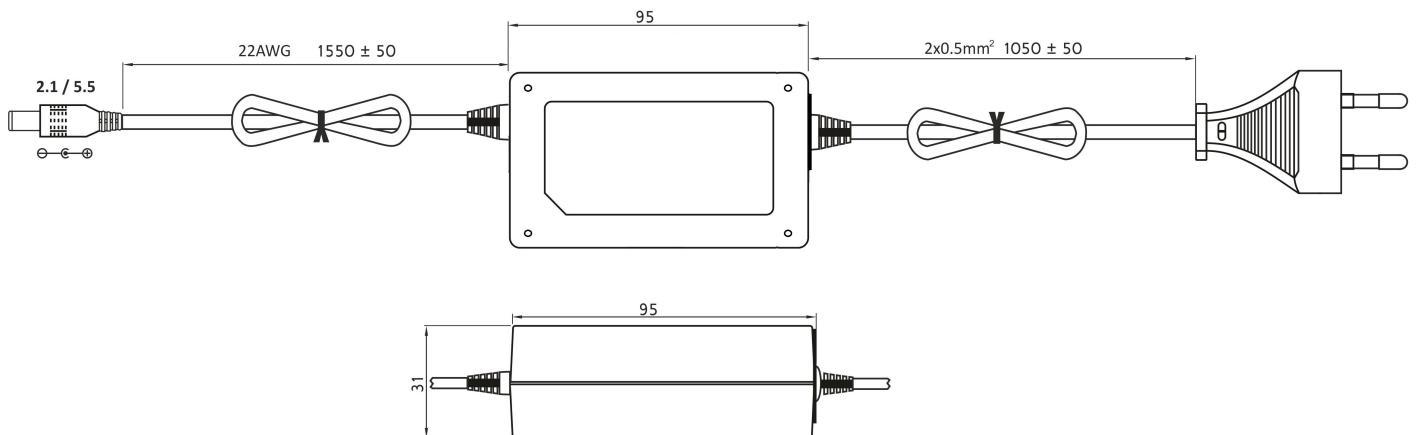

1. All parameters NOT specially mentioned are measured at 230VAC input, rated load and 25°C of ambient temperature.
2. Ripple & noise are measured at 20MHz of bandwidth by using a 12" twisted pair-wire terminated with a 0.1μF i 47μF parallel capacitor.
3. Tolerance includes set up tolerance, line regulation and load regulation.
4. Setup and rise time is measured from 0 to 90% rated output voltage.
5. Power supply is considered as component not indented to apply by end-user. Power supply meets safety and EMC standards however the final equipment with power supply must be re-quality to comply with EMC Directives.

X-ON Electronics

Largest Supplier of Electrical and Electronic Components

Click to view similar products for [Desktop AC Adapters](#) category:

Click to view products by [POS manufacturer](#):

Other Similar products are found below :

[212A2136](#) [ADP485-01](#) [SWA-1202](#) [SWA-1501](#) [212A2220](#) [432703037451](#) [KR8-PS01](#) [1894875](#) [FWE050024B-10A](#) [820A4080G](#) [825A0057-03](#) [SWA-1704W](#) [AD5012N2LM-\(401\)](#) [SDI65-24-UDC-P5R](#) [TRH21A120-49E03-Level-VI](#) [FWC100024A-11A](#) [FWE050012B-10A](#) [AC-DC ADAPTER 90W w/ Cable](#) [FWA065024A-11A](#) [PSA120U-560L6](#) [FWE050024A-10A](#) [96PSA-A63W18V1-M](#) [1895235](#) [PW-C0725-W2-B](#) [57-U1](#) [57-U2](#) [CENB1040A1245F02](#) [SED80N2-16.0](#) [SED80N3-16.0](#) [RFQ43442-01](#) [YS50-1903150](#) [50966124050E](#) [96PSA-A36W12R1-3](#) [PCM50UT04](#) [PCM50UT05](#) [Adapter 24V230W FSP230-AAAN3 WIRE FSP](#) [TRH100A240-11E12 VI](#) [TR70MB360-01E03 VI](#) [TRH50A240-11E01 VI](#) [TRE36A120-01G03 VI](#) [TRH100A180-11E12 VI](#) [POSC12250D-C8-WH](#) [POSC12300D-C8-WH](#) [POSC12500D-C8-WH](#) [SYS1588-3015-T2](#) [SYS1588-3018-T2](#) [SYS1588-3024-T2](#) [CPSUNOTAKY-07056](#) [CPSUNOTAKY-07058](#) [CPSUNOTAKY-07168](#)