

POSC12050A-1555 series

12V / 0.5A Wall mounted type AC/DC adaptor



■ Features:

- Universal AC input / Full range
- ErP step II / CEC level VI compliance
- MTBF > 100.000 h
- Protections: Overload / Short circuit / Over Voltage



ELECTRICAL SPECIFICATION

MODEL	POSC12050A-1555
-------	-----------------

OUTPUT

Rated Voltage	12V
Rated Current	0.5A
Current Range	0 ÷ 0.5A
Rated Power	6W
Line Regulation	± 5%
Load Regulation	± 5%
Tolerance [3]	± 8%
Ripple & Noise (max.) [2]	200mV _{p-p}
Rise Time [4]	100ms / 230VAC at 10% to 90% load
Hold up Time (typ.)	3ms / 230VAC at full load

INPUT

Voltage Range	90 ÷ 264VAC
Frequency Range	47 ÷ 63Hz
Efficiency (typ.)	78.88% - Input115/230Vac / Average (25%+50%+75%+100%) /4
AC Current (typ.)	0.2A / 230VAC
No load Power Consumption (max.)	<0.10W

PROTECTIONS

Overload	0.6A-1.1A Auto-recovery.
Short Circuit	Type: hiccup mode, auto-recovery.
Over Voltage	Type: auto-recovery.

POSC12050A-1555 series

12V / 0.5A Wall mounted type AC/DC adaptor



WORKING ENVIRONMENT

Working Temperature	-5°C ÷ 40°C
Working Humidity	5 ÷ 95% RH non-condensing
Storage Temperature and Humidity	-40°C ÷ 85°C, 5 ÷ 90% RH non-condensing

SAFETY and EMC REGULATIONS

Safety Standards	Compliance to EN 62368
Withstand Voltage	IN/OUT: 3.6kVAC
Isolation Resistance	IN/OUT: 50MΩ/500VDC/25°C/70%
EMC Emission	Compliance to EN55032
EMC Immunity	Compliance to EN61000-4-2, -3, -4, -5
Harmonic Current	Compliance to EN61000-3-3; EN61000-3-2

OTHERS

DC wire and plug	Wire: 24AWG*2C, length = 1500mm	DC Plug: 1.5/5.5mm center positive
Net Weight / Dimensions	60g / 56.0 x 28.0 x 42.0mm (L x W x H)	

MECHANICAL SPECIFICATION



POSC12050A-1555 series

12V / 0.5A Wall mounted type AC/DC adaptor



MECHANICAL SPECIFICATION: DC wire and plug

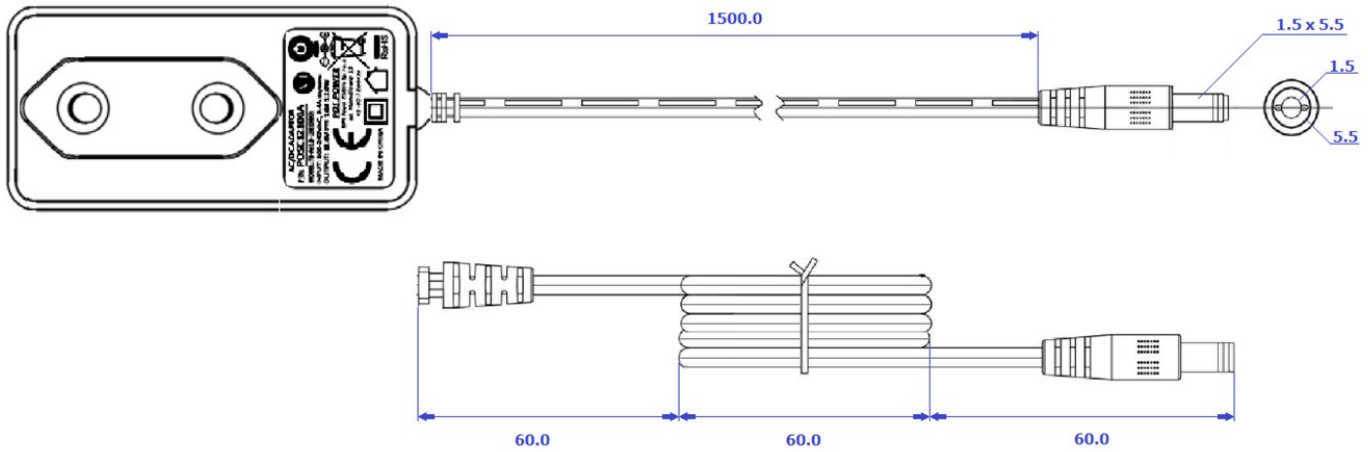

MODEL	DC PLUG	X [mm]	Y [mm]	Polarity
POSC12050A	5.5x2.1mm	5.5	2.1	center positive
POSC12050A-1555	5.5x1.5mm	5.5	1.5	center positive
POSC12050A-1335	3.5x1.3mm	3.5	1.3	center positive
POSC12050A-1740	4.0x1.7mm	4.0	1.7	center positive
POSC12050A-1748	4.8x1.7mm	4.8	1.7	center positive
POSC12050A-CN	5.5x2.1mm	5.5	2.1	center negative
POSC12050A-2555-CN	5.5x2.5mm	5.5	2.5	center negative
POSC12050A-1335-CN	3.5x1.3mm	3.5	1.3	center negative
POSC12050A-1740-CN	4.0x1.7mm	4.0	1.7	center negative
POSC12050A-1748-CN	4.8x1.7mm	4.8	1.7	center negative

1. All parameters NOT specially mentioned are measured at 230VAC input, rated load and 25°C of ambient temperature.
2. Ripple & noise are measured at 20MHz of bandwidth by using a 12" twisted pair-wire terminated with a 0.1μF i 47μF parallel capacitor.
3. Tolerance includes set up tolerance, line regulation and load regulation.
4. Setup and rise time is measured from 0 to 90% rated output voltage.
5. Power supply is considered as component not indented to apply by end-user. Power supply meets safety and EMC standards however the final equipment with power supply must be re-quality to comply with EMC Directives.

X-ON Electronics

Largest Supplier of Electrical and Electronic Components

Click to view similar products for POS manufacturer:

Other Similar products are found below :

[POSB12200A](#) [POS05200A-WH](#) [POS15200D](#) [POSC09100A-25](#) [POS15100D](#) [POSB05310A-2USB](#) [POSC24100A-25](#) [POSB12200A-WH25](#)
[POSB09100A-WH](#) [POSB12300D-2555](#) [POSC12500D-C8-25](#) [POS05300A-USB-C](#) [POSB12150A](#) [POSC12333D-C14-25](#) [POSC24150A-H-2555](#) [POSC12300D-C8-25](#) [POSB12500D-2555](#) [POS12200A-25](#) [POSB06100A](#) [POSB12100D-2555](#) [POS12150A-WH](#) [POSB24050A](#)
[POSB12200D-2555](#) [POSC12200A-25](#) [POS24100A-25](#) [POSB12200D](#) [POSC18333D-C14](#) [POSB05200A-USBC](#) [POS05200A-2555](#)
[POS05200A-WH13](#) [POSC24150A-H](#) [POS05200A-2555L](#) [POSB12300D](#) [POSB24100A](#) [POSB12200A-WH](#) [POSB12200A-25](#) [POSB12300A-WH](#) [POSC121000D-C14](#) [POSC09100A](#) [POSC24100A-H](#) [POSC12100A-25](#) [POSC12500D-C14](#) [POSC20600D-2555-C14](#) [POSC07100A](#)
[POSC17100A](#) [POSB12050A-WH](#) [POSB12150A-WH](#) [POSC12125A-25](#) [POS06100A-WH](#) [POSB05400A-USBC](#)