

COMBO-D

D-subminiature Connectors



Positronic[®]
an Amphenol company

LOOK FOR OUR
NEW PRODUCTS!



**SIGNAL, POWER, AIR,
SHIELDED, THERMOCOUPLE OR
HIGH VOLTAGE CONTACTS
IN A SINGLE PACKAGE**

Catalog C-004 Rev. F2

www.connectpositronic.com

Connector Excellence[®]

Positronic Provides Complete Capability

Mission Statement

"To utilize product flexibility and application assistance to present quality interconnect solutions which represent value to customers worldwide."

Experience

- Founded in **1966**
- **Involvement** in the development of international connector specifications through EIA[®], IEC and ISO as well as PICMG[®].
- Introduction of new and **unique connector products** to the electronics industry.
- Patent holder for many **unique connector features and manufacturing techniques**.
- **Vertically integrated** manufacturing – raw materials to finished connectors.

Technology

- **Expertise** with solid machined contacts provides a variety of high reliability connectors including high current density power connectors.
- Quality Assurance lab is **capable of testing** to IEC, EIA, UL, CUL, military and customer-specified requirements.
- **In-house design and development** of connectors based on market need or individual customer requirements.
- **Internal manufacturing capabilities** include automatic precision contact machining, injection molding, stamping, plating operations and connector assembly.
- **Manufacturing locations** in southwest Missouri, U.S.A. (headquarters); Puerto Rico, France, China, Singapore, and India. Total square footage: 407,441.

Support

- **Quality Systems:** Select locations qualified to ISO 9001, ISO 14001, AS9100, MIL-STD-790 and customer "dock to stock" programs. Applicable products qualified to MIL-DTL-24308, AS39029, DSCC 85039, MIL-DTL-28748, Space D32, GSFC S-311-P-4 and GSFC S-311-P-10.
- Compliance to a variety of international and customer specific **environmental requirements**.
- Large **in-house inventory** of finished connectors. Customer specific **stocking programs**.
- Factory direct **technical sales support** in major cities worldwide.
- **One-on-one customer support** from worldwide factory locations.
- World class **web site**.
- **Value-added solutions** and willingness to **develop custom products** with reasonable price and delivery.



Regional Headquarters

Springfield, MO



Auch, France



Singapore



Products described within this catalog may be protected by one or more of the following US patents:

#4,900,261[†] #5,255,580 #5,329,697
#6,260,268 #6,835,079 #7,115,002

[†]Patented in Canada, 1992 Other Patents Pending

Positronic Industries' **FEDERAL SUPPLY CODE** (Cage Code)
FOR MANUFACTURERS is **28198**

Unless otherwise specified, **dimensional tolerances** are:

- 1) ± 0.001 inches [0.03 mm] for male contact mating diameters.
- 2) ± 0.003 inches [0.08 mm] for contact termination diameters.
- 3) ± 0.005 inches [0.13 mm] for all other diameters.
- 4) ± 0.015 inches [0.38 mm] for all other dimensions.

POSITRONIC[®] IS AN ITAR REGISTERED COMPANY

Information in this catalog is proprietary to Positronic and its subsidiaries. Positronic believes the data contained herein to be reliable. Since the technical information is given free of charge, the user employs such information at his own discretion and risk. Positronic Industries assumes no responsibility for results obtained or damages incurred from use of such information in whole or in part.

The following trademarks are registered to Positronic Industries, Inc. in the United States and many other countries: Positronic Industries, Inc.[®], Positronic[®], Connector Excellence[®], P+ logo[®], PosiBand[®], PosiShop[®], Positronic Global Connector Solutions[®], Global Connector Solutions[®]. The color blue as it appears on various connectors is a trademark of Positronic Industries, Inc., Registered in U.S. Patent and Trademark Office.

CONNECTOR DESCRIPTIONS



COMBINATION D-SUBMINIATURE STANDARD AND HIGH DENSITY

CB series connectors are available in standard density versions, which have fixed size 20 signal contacts and size 8 power, shielded, high voltage and air contacts. High density CB series connectors offer fixed size 22 signal contacts, size 8 contacts or size 16 power contacts. These connectors are available in various performance levels for best cost/performance ratio. Thermocouple contact options are also available.



COMBINATION D-SUBMINIATURE CRIMP CONTACTS STANDARD AND HIGH DENSITY

CBC series connectors offer crimp removable contacts for signal, power, shielded, high voltage and air contacts applications. These connectors are available in standard and high density versions. Thermocouple contact options are also available.

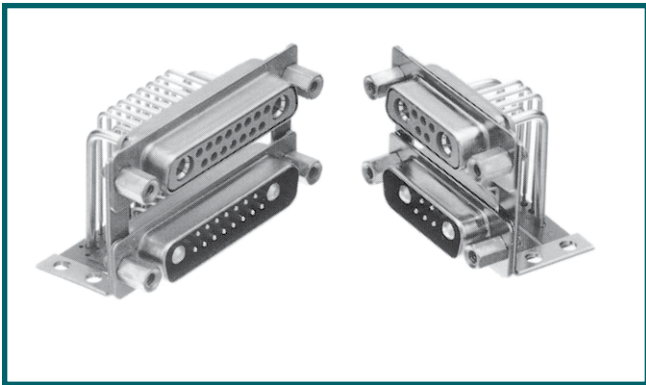

COMBINATION CONTACT DUAL PORT CONNECTORS

CBDP series. Offers seventeen different combinations of power and signal contact stacked assemblies. Size 20 signal contacts and size 8 power contacts.

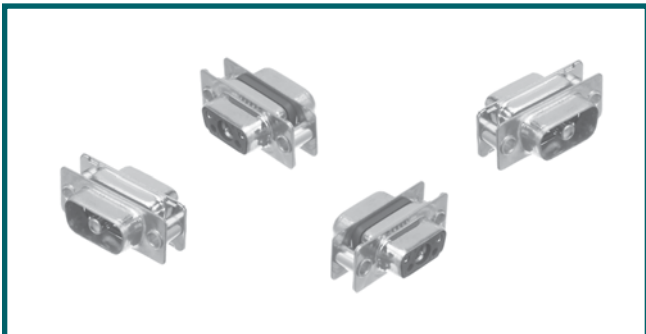

COMBO-D CONNECTOR SAVERS - ACBDP and ACBMP SERIES

ACBDP and ACBMP series. Combo-D connector savers with size 20 and size 8 contacts. Available for all standard Combo-D variants in shell sizes 1 through 6.



GENERAL INFORMATION

Temperature Rise Curves	1-2
-------------------------------	-----

CBD / CBM SERIES

CBD/CBM Series Introduction	3
Technical Characteristics	4
Contact Variants	5
Standard Shell Assembly	6
Code 2 Solder Cup Connector and Code 3, 35, 36 and 37 Straight Printed Board Mount Connector	7
Code 5, 55 and 57 Right Angle (90°) Printed Board Mount Connector	8
Code 5, 55 and 57 Shell Size 6 - Right Angle (90°) Printed Board Mount Connector	9
Code 7, 75 and 77 Metric System Right Angle (90°) Printed Board Mount Connector	10
Right Angle (90°) and Straight Printed Contact Hole Pattern with 0.078 [1.98] ϕ , 0.094 [2.39] ϕ and 0.125 [3.18] ϕ Power Contacts	11-12
Right Angle (90°) Printed Board Contact Hole Pattern with 0.125 [3.18] ϕ Power Contacts	13-14
Code 65 Straight Printed Board Mount Connector with FDS4201D or MDS4201D Shielded Contacts and Code 85 Right Angle (90°) Printed Board Mount Connector with FDS4201D or MDS4201D Shielded Contacts	15
Straight Printed Board Mount Contact Hole Pattern with FDS4201D and MDS4201D Shielded Contacts	16-17
Right Angle (90°) Printed Board Mount Contact Hole Pattern with FRT4201D and MRT4201D Shielded Contacts	18-19
Code 93 Compliant Press-fit Connector and Temperature Rise Curve	20
Ordering Information	21

CBC SERIES

CBC Series Introduction	22
Technical Characteristics	23
Contact Variants	24
Standard Shell Assembly	25
Ordering Information	26

CBDD / CBHD SERIES

CBDD/CBHD Series Introduction and Technical Characteristics	27-28
Contact Variants	28
Standard Shell Assembly	29
Code 21 Solder Cup Connector and Code 3, 35, 36 and 37 Straight Printed Board Mount Connector	30
Code 4, 45 and 47 Right Angle (90°) Printed Board Mount Connector	31-33
Code 65 Straight Printed Board Mount Connector with FDS4201D or MDS4201D Shielded Contacts and Code 84 Right Angle (90°) Printed Board Mount Connector with FRT4201D or MRT4201D Shielded Contacts	34
Code 85 Right Angle (90°) Printed Board Mount Connector with FRT4201D or MRT4201D Shielded Contacts and Code 93 Compliant Press-Fit Connector	35
Printed Board Mount Contact Hole Pattern	36
Ordering Information	37-38



C B C D S E R I E S

CBCD Series Introduction	39
Technical Characteristics	39-40
Contact Variants	40
Standard Shell Assembly	41
Ordering Information	42

C B D P B / C B D P C S E R I E S

Combo-Dual Port Series Introduction	43
Technical Characteristics	43-44
Contact Variants	44
Right Angle (90°) Printed Board Mount Connector	45
Right Angle (90°) Printed Board Mount Contact Hole Pattern	46-47
Ordering Information	48

C O N N E C T O R S A V E R S

ACBDP/ACBMP Series Introduction	57
Technical Characteristics	58
ACBDP/ACBMP Series Size 20 and Size 8 Contact Variants	58
Male to Female Connector Saver and Jackscrew Systems	59
Ordering Information	60

U N I Q U E F E A T U R E S

Unique Features Introduction and Sequential Mating Contacts	61
Size 8 Contact Stabilization Feature	62
Combo-D Connectors with 100 AMP High Current Removable Crimp Power Contacts Technical Characteristics and 100 AMP High Current Removable Crimp Power Contacts (for use with 8 AWG wire)	63
Selectively Loaded Combo-D Connectors for use with 100 AMP High Current Removable Crimp Power Contacts and Temperature Rise Curve	64
Size 8 Straight Printed Board Mount High Voltage Contact	65
Size 8 Right Angle (90°) Printed Board Mount High Voltage Contact	65
Size 8 Bus Bar Power Contacts	66
Size 8 Integral Blind Mate Guide	66
Customer Specified Contact Termination Length	67

continued on next page . . .

**Visit our web site for the latest catalog updates and supplements at
www.connectpositronic.com/combo-d/catalogs**



Positronic
connectpositronic.com

TABLE OF CONTENTS

Combo-D
D-Sub

SPECIAL OPTIONS

APPLICATION TOOLS

QPL LISTING

REMOVABLE CONTACTS

Removable Contact Technical Characteristics	68-69
What makes PosiBand® contact interface significant	69
Size 22 Crimp and Removable Signal Crimp Contacts.....	70-71
Size 22 Removable Thermocouple Signal Crimp Contact	71
Size 20 Crimp and Removable Crimp Signal Contact	72-73
Size 20 Removable Thermocouple Crimp Signal Contact	74
Size 16 Removable Crimp Power Contacts	74
Size 8 Removable Crimp Power Contacts	75
Size 8 Removable Solder Cup Power Contacts.....	75
Size 8 Removable High Voltage Power Contacts	76
Size 8 Straight Printed Board Mount Power Contact	76
Size 8 Right Angle (90°) Printed Board Power Contact	77
Size 8 Removable Shielded Contact	78
Size 8 Straight Printed Board Mount Shielded Contact	79
Size 8 Right Angle (90°) Printed Board Shielded Contact	79

SPECIAL OPTIONS

Modification (MOS) Suffixes	81
-----------------------------------	----

APPLICATION TOOLS

Introduction	82
Contact Reels for Automatic Pneumatic Crimp Tools.....	82
Contact Application Tools Cross Reference List	83-84
Suggested Printed Board Hole Sizes For Compliant Press-Fit Connectors.....	85
Compliant Press-Fit Connector Installation Tools.....	86

QPL LISTING

Positronic offers a wide variety of QPL connector products	87
--	----



TEMPERATURE RISE CURVES FOR SIZE 8, 10 AND 12 AWG WIRE

7W2

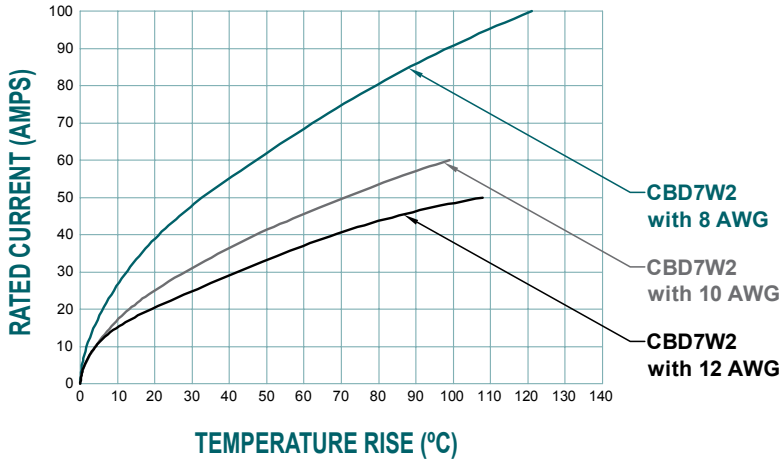

Test conducted in accordance with UL1977.
All power contacts under load.

- MC4008D:** Curve developed using a mated CBD7W2F57 and CBC7W2M loaded with MC4008D contacts terminated to 8 AWG wire.
- MC4010D:** Curve developed using a mated CBD7W2F36 and CBC7W2M loaded with MC4010D contacts terminated to 10 AWG wire.
- MC4012D:** Curve developed using a mated CBD7W2F55 and CBC7W2M loaded with MC4012D contacts terminated to 12 AWG wire.

21WA4

Test conducted in accordance with UL1977.
All power contacts under load.

- MC4008D:** Curve developed using a mated CBD21WA4F57 and CBC21WA4M loaded with MC4008D contacts terminated to 8 AWG wire.
- MC4010D:** Curve developed using a mated CBD21WA4F36 and CBC21WA4M loaded with MC4010D contacts terminated to 10 AWG wire.
- MC4012D:** Curve developed using a mated CBD21WA4F55 and CBC21WA4M loaded with MC4012D contacts terminated to 12 AWG wire.

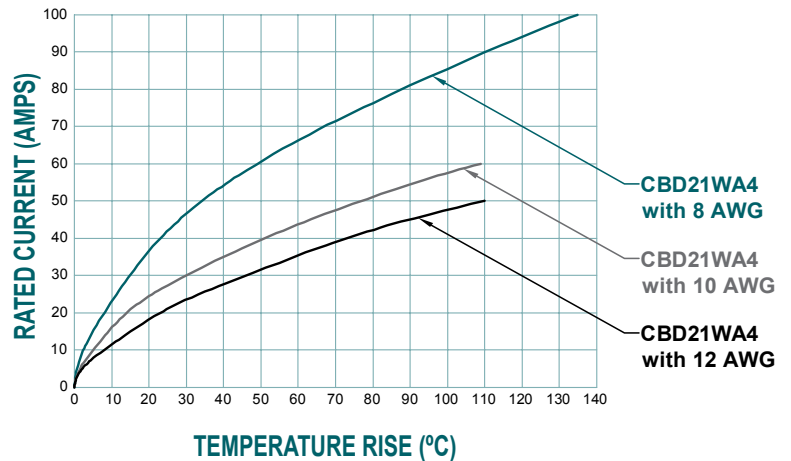

Test conducted in accordance with UL1977.
All power contacts under load.

- MC4008D:** Curve developed using a mated CBD8W8F57 and CBC8W8M loaded with MC4008D contacts terminated to 8 AWG wire.
- MC4010D:** Curve developed using a mated CBD8W8F36 and CBC8W8M loaded with MC4010D contacts terminated to 10 AWG wire.
- MC4012D:** Curve developed using a mated CBD8W8F55 and CBC8W8M loaded with MC4012D contacts terminated to 12 AWG wire.

8W8

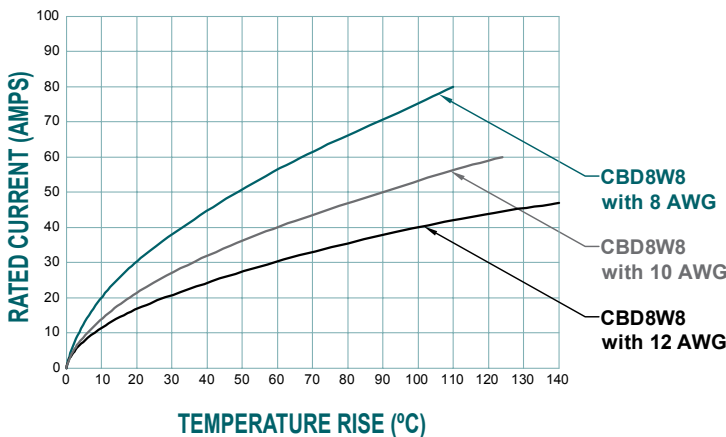



TEMPERATURE RISE CURVE FOR STANDARD AND HIGH CONDUCTIVITY CONTACT MATERIAL

3W3

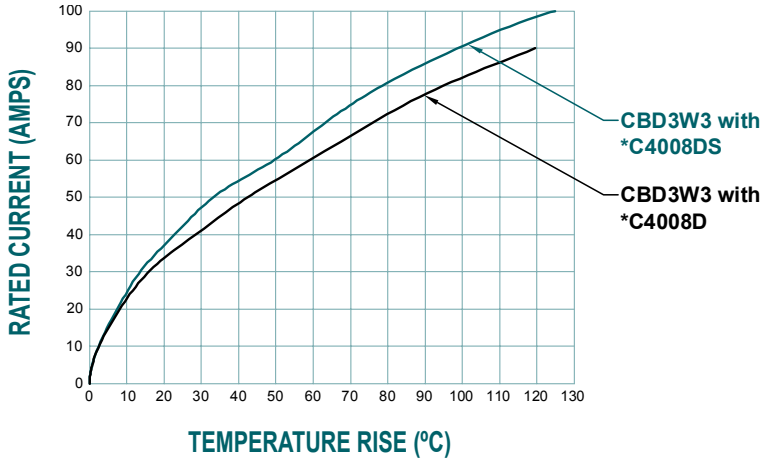

**Test conducted in accordance with UL1977.
All power contacts under load.**

Standard Material: Curve developed using a mated CBD3W3F loaded with FC4008D contacts and CBD3W3M loaded with MC4008D contacts terminated to 8 AWG wire.

High Conductivity: Curve developed using a mated CBD3W3F loaded with FC4008DS contacts and CBD3W3M loaded with MC4008DS contacts terminated to 8 AWG wire.

* indicates contact gender

8W8

**Test conducted in accordance with UL1977.
All power contacts under load.**

Standard Material: Curve developed using a mated CBD8W8F loaded with FC4008D contacts and CBD8W8M loaded with MC4008D contacts terminated to 8 AWG wire.

High Conductivity: Curve developed using a mated CBD8W8F loaded with FC4008DS contacts and CBD8W8M loaded with MC4008DS contacts terminated to 8 AWG wire.

* indicates contact gender

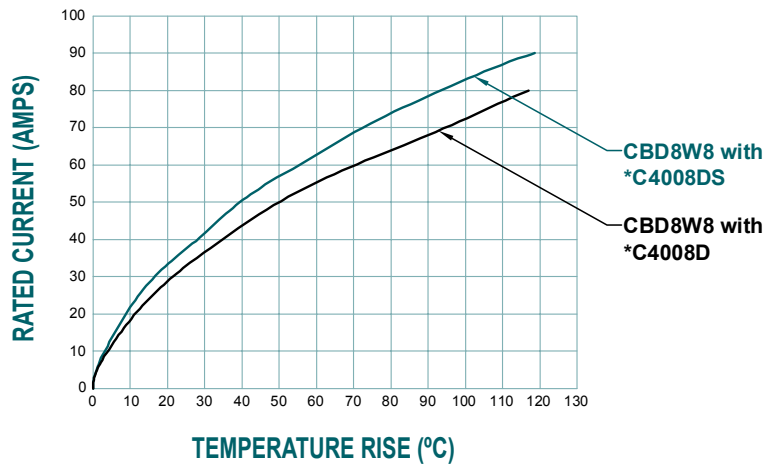

TEMPERATURE RISE (°C)

HIGH DENSITY 8W2

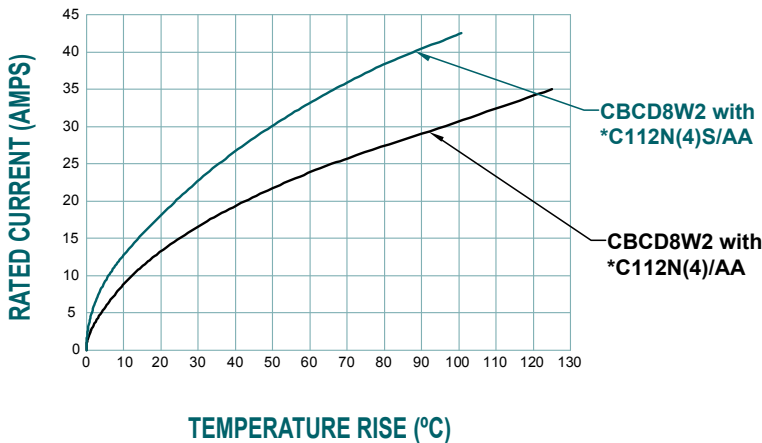

**Test conducted in accordance with UL1977.
All power contacts under load.**

Standard Material: Curve developed using a mated CBCD8W2M loaded with MC112N/AA-133.0 contacts and CBCD8W2S loaded with FC112N4/AA contacts terminated to 12 AWG wire.

High Conductivity: Curve developed using a mated CBCD8W2M loaded with MC112NS-133.0 contacts and CBCD8W2S loaded with FC112N4S/AA contacts terminated to 12 AWG wire.



Positronic
connectpositronic.com

PROFESSIONAL, INDUSTRIAL AND MILITARY QUALITY
THREE PERFORMANCE LEVELS FOR BEST COST/PERFORMANCE RATIO
STANDARD DENSITY PCB MOUNT

Combo-D
D-Sub

**Size 20 Fixed Signal and
Thermocouple Contacts**
**Size 8 Removable Power, Shielded,
Air and High Voltage Contacts**

UL Recognized
File #E49351

CSA Recognized
File #LR54219

DSCC 85039

Telecommunication UL File #E140980



Combo-D series connectors permit mixed contact combinations of power, shielded, air, high voltage and signal contacts within the same connector body. Twenty-two connector variants are offered in six standard shell sizes.

Three performance levels of Combo-D series connectors are offered: professional, industrial and military. CBD series connectors are quality connectors recommended for use in sheltered, non-corrosive indoor and outdoor environments having normal ventilation, but without temperature or humidity controls. Signal contacts are offered with open entry professional level or PosiBand closed entry industrial level signal contacts. CBD series connectors meet performance requirements of IEC 60807-2, Performance Level One or Two. CBM series connectors are military quality connectors recommended for use in sheltered, mildly corrosive environments having a wide range of temperature, pressure and humidity changes. CBM series connectors will meet the applicable performance requirements of DSCC 85039.

Combo-D series connectors utilize precision machined signal contacts. Connector variants are available with contact terminations for solder and straight and right angle (90°) printed board mount terminations featuring a choice of inch or metric printed board footprints.

Power, shielded and high voltage contacts are removable, having solder and straight and right angle (90°) printed board mount terminations. Power and shielded contacts are available with crimp terminations. Air contact options are also available, see page 80 for details.

For low level shielding requirements, ferrite inductors may be attached to both signal and power contacts of connectors having contact terminations which are straight or right angle (90°) for printed board mounting applications. For additional information contact Technical Sales.

The female power contacts feature the Large Surface Area (L.S.A.) closed entry contact design which provides maximum mating surfaces between male and female contacts and reduced contact resistance during operation.

A wide assortment of printed board mounting hardware, cable support hoods, and locking systems is available from stock.

A blind mating system is available for applications requiring connector coupling in recessed areas or mobile power coupling systems.

Straight and right angle (90°) PCB mount thermocouple contacts are available, please contact Technical Sales for details.



TECHNICAL CHARACTERISTICS

MATERIALS AND FINISHES:

Insulator:	Glass filled polyester per ASTM D 5927 UL 94V-0, blue color, and composite.
Contacts:	Precision machined copper alloy.
Contact Plating:	
SIGNAL:	Gold flash over nickel plate and gold 0.000050 [1.27μ] over nickel plate. Other finishes available upon request, see page 81.
POWER:	Gold flash over nickel. Other finishes available upon request, see page 81.
SHIELDED:	For contact platings, see page 68.
HIGH VOLTAGE:	For contact platings, see page 68.
Shells:	Steel with tin plate; zinc plate with chromate seal; stainless steel passivated. Other materials and finishes available upon request.
Mounting Spacers and Brackets:	Nylon; polyester; copper alloy or steel with zinc plate and chromate seal or tin plate; phosphor bronze with tin plate; stainless steel, passivated.
Push-On Fasteners:	Phosphor bronze and beryllium copper with tin plate.
Jackscrew Systems:	Brass or steel with zinc plate and chromate seal or clear zinc plate or tin plate; stainless steel, passivated.
Hoods:	Composite and plastic, UL 94V-0; brass or steel with zinc plate and chromate seal. Aluminum; aluminum with electroless nickel plate. For aluminum hoods, zinc content is 1% maximum. Die cast zinc.

Non-magnetic versions are available, contact Technical Sales.

MECHANICAL CHARACTERISTICS:

Signal Contacts, Fixed:	Size 20 contacts, male - 0.040 inch [1.02mm] diameter. CBD series has open entry female contacts. PosiBand closed entry female options are also available. CBM series has PosiBand closed entry female contacts, see page 68 for details.
Contact Retention in Insulator:	Signal: 9 lbs. [40N]. Power, shielded and high voltage: 22 lbs [98N].
Resistance to Solder Iron Heat:	500°F [260°C] for 10 seconds duration per IEC 60512-6.
Signal Contact Terminations:	Solder contacts - 0.042 inch [1.06mm] minimum hole diameter for 20 AWG [0.5 mm ²] wire maximum. Straight Printed Board Mount - 0.028 inch [0.71mm] termination diameter. Right Angle (90°) Printed Board Mount - 0.028 inch [0.71 mm] termination diameter.
Power Contacts, Removable, Crimp or Solder Termination:	Size 8 contact, male - 0.142 inch [3.61mm] mating diameter. Terminations for 6, 8, 10, 12, and 16 AWG. Female contact features Large Surface Area (L.S.A.) closed entry contact design utilizing BeCu mechanical retention member. Closed crimp barrel.
Power Contacts, Printed Board Mount:	Size 8 contact, male - 0.142 inch [3.61mm] mating diameter. Printed board terminations with 0.078 inch [1.98mm], 0.094 inch [2.39mm] and 0.125 inch [3.18mm] termination diameters.
Shielded Contacts, Removable:	See table of cable sizes for contact termination dimensions, page 78.

High Voltage Contacts:	Straight and right angle (90°) terminations - 0.041 inch [1.04mm] minimum hole diameter.
Shells:	Male shells may be dimpled for EMI/ESD ground paths.
Polarization:	Trapezoidally shaped shells and polarized jackscrews.
Mounting to Angle Brackets:	Jackscrews and riveted fasteners with 0.120 inch [3.05mm] diameter hole, and threaded riveted fasteners with 4-40 threads and nylon inserts.
Mounting to Printed Board:	Rapid installation push-on fasteners and threaded posts.
Locking Systems:	Jackscrews and vibration locking systems.
Mechanical Operations:	CBD series, open entry contacts, 500 operations. CBD series, PosiBand closed entry and CBM series, 1,000 operations. Per IEC 60512-5.

ELECTRICAL CHARACTERISTICS:

SIZE 20 CONTACTS

Contact Current Rating:	7.5 amperes nominal.
Initial Contact Resistance:	0.008 ohms maximum.
Proof Voltage:	1000 V r.m.s.

SIZE 8 CONTACTS

POWER CONTACTS

Contact Current Rating - Tested per UL 1977:

Standard Contact Material:	
0.078 inches diameter / 12 AWG terminations:	39 amperes.
0.094 inches diameter / 10 AWG terminations:	50 amperes.
0.125 inches diameter / 8 AWG terminations:	70 amperes.

See *Temperature Rise Curves on page 1 for details.*

High Conductivity Contact Material:

8 AWG terminations:	80 amperes.
----------------------------	-------------

See *Temperature Rise Curves on page 2 for details.*

Initial Contact Resistance:

Standard Contact Material:	0.0005 ohms max. per IEC 60512-2, Test 2b.
-----------------------------------	--

High Conductivity Contact Material: 0.00035 ohms max. per IEC 60512-2, Test 2b.

Proof Voltage:	1000 V r.m.s.
-----------------------	---------------

SHIELDED CONTACTS

For electrical characteristics, see page 69.

HIGH VOLTAGE CONTACTS

For electrical characteristics, see page 69.

CONNECTOR

Insulation Resistance:	5 G ohms.
Clearance and Creepage Distance:	0.039 [1.0mm] minimum.
Working Voltage:	300 V r.m.s.

CLIMATIC CHARACTERISTICS:

Temperature Range:	-55°C to +125°C.
Damp Heat, Steady State:	10 days.

THERMOCOUPLE CONTACTS:

Straight and right angle PCB mount contacts are available, please contact Technical Sales for details.

Size 20 crimp contacts are available in CBC series, see page 74 for details.



Positronic
connectpositronic.com

PROFESSIONAL, INDUSTRIAL AND MILITARY QUALITY
THREE PERFORMANCE LEVELS FOR BEST COST/PERFORMANCE RATIO
STANDARD DENSITY PCB MOUNT

Combo-D
D-Sub

CONTACT VARIANTS

FACE VIEW OF MALE OR REAR VIEW OF FEMALE

— SHELL SIZE 1 —



*1 2WK2



5W1

Note: Connectors can be kitted with all applicable removable contacts, contact Technical Sales for connector part number.

— SHELL SIZE 2 —



3W3



*2 3WK3

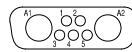

7W2

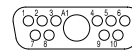

11W1

— SHELL SIZE 3 —



5W5

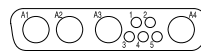

9W4

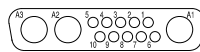

13W3

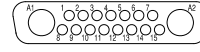

17W2

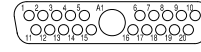

21W1

— SHELL SIZE 4 —

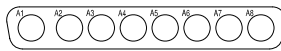

8W8

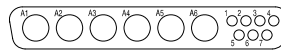

13W6

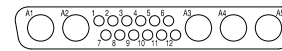

17W5

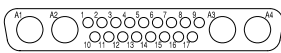

21WA4

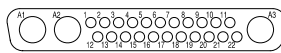

25W3

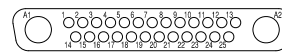

27W2

— SHELL SIZE 5 —

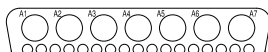

24W7

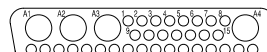

36W4



43W2



47W1

— SHELL SIZE 6 —

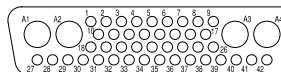

46W4

Notes:

*1 2WK2 connectors have 1 male and 1 female contacts. Female connector should be loaded with female contact in A2 position.

*2 3WK3 male variant contains 2 male contacts and 1 female contact. Female variant contains 2 female contacts and 1 male contact



STANDARD SHELL ASSEMBLY



CBD3W3M0000

CBD5W5M0000

RECOMMENDED MATING DIMENSIONS

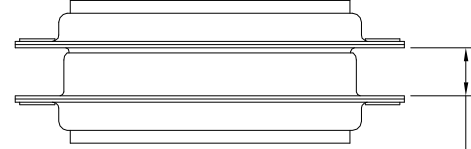

Shell Sizes 1 & 2 =
0.265±0.015 [6.73±0.38]
Shell Sizes 3, 4, 5 & 6 =
0.256±0.015 [6.50±0.38]

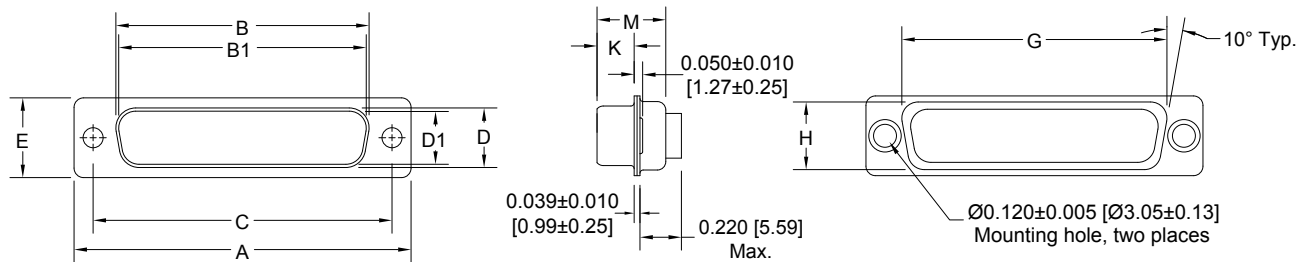

OPTIONAL SHELL ASSEMBLY (0, 02)

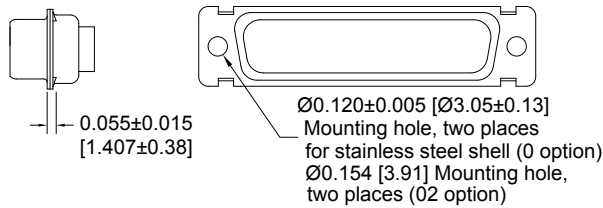

OPTIONAL SHELL ASSEMBLY
WITH UNIVERSAL FLOAT MOUNTS (F)

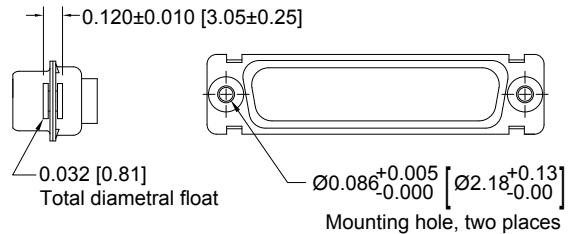

SHELL SIZES	A ±0.015 [0.38]	B ±0.005 [0.13]	B1 ±0.005 [0.13]	C ±0.005 [0.13]	D ±0.005 [0.13]	D1 ±0.005 [0.13]	E ±0.015 [0.38]	G ±0.010 [0.25]	H ±0.010 [0.25]	K ±0.005 [0.13]	M ±0.010 [0.25]
SHELL SIZE 1 MALE	1.213 [30.81]		0.666 [16.92]	0.984 [24.99]		0.329 [8.36]	0.494 [12.55]	0.759 [19.28]	0.422 [10.72]	0.233 [5.92]	0.422 [10.72]
SHELL SIZE 1 FEMALE	1.213 [30.81]	0.643 [16.33]		0.984 [24.99]	0.311 [7.90]		0.494 [12.55]	0.759 [19.28]	0.422 [10.72]	0.243 [6.17]	0.429 [10.90]
SHELL SIZE 2 MALE	1.541 [39.14]		0.994 [25.25]	1.312 [33.32]		0.329 [8.36]	0.494 [12.55]	1.083 [27.51]	0.422 [10.72]	0.233 [5.92]	0.422 [10.72]
SHELL SIZE 2 FEMALE	1.541 [39.14]	0.971 [24.66]		1.312 [33.32]	0.311 [7.90]		0.494 [12.55]	1.083 [27.51]	0.422 [10.72]	0.243 [6.17]	0.429 [10.90]
SHELL SIZE 3 MALE	2.088 [53.04]		1.534 [38.96]	1.852 [47.04]		0.329 [8.36]	0.494 [12.55]	1.625 [41.28]	0.422 [10.72]	0.230 [5.84]	0.426 [10.82]
SHELL SIZE 3 FEMALE	2.088 [53.04]	1.511 [38.38]		1.852 [47.04]	0.311 [7.90]		0.494 [12.55]	1.625 [41.28]	0.422 [10.72]	0.243 [6.17]	0.429 [10.90]
SHELL SIZE 4 MALE	2.729 [69.32]		2.182 [55.42]	2.500 [63.50]		0.329 [8.36]	0.494 [12.55]	2.272 [57.71]	0.422 [10.72]	0.230 [5.84]	0.426 [10.82]
SHELL SIZE 4 FEMALE	2.729 [69.32]	2.169 [54.84]		2.500 [63.50]	0.311 [7.90]		0.494 [12.55]	2.272 [57.71]	0.422 [10.72]	0.243 [6.17]	0.429 [10.90]
SHELL SIZE 5 MALE	2.635 [66.93]		2.079 [52.81]	2.406 [61.11]		0.441 [11.20]	0.605 [15.37]	2.178 [55.32]	0.534 [13.56]	0.230 [5.84]	0.426 [10.82]
SHELL SIZE 5 FEMALE	2.635 [66.93]	2.064 [52.43]		2.406 [61.11]	0.423 [10.74]		0.605 [15.37]	2.178 [55.32]	0.534 [13.56]	0.243 [6.17]	0.429 [10.90]
SHELL SIZE 6 MALE	2.729 [69.32]		2.212 [56.18]	2.500 [63.50]		0.503 [12.78]	0.668 [16.97]	2.302 [58.47]	0.596 [15.14]	0.230 [5.84]	0.426 [10.82]
SHELL SIZE 6 FEMALE	2.729 [69.32]	2.189 [55.60]		2.500 [63.50]	0.485 [12.32]		0.668 [16.97]	2.302 [58.47]	0.596 [15.14]	0.243 [6.17]	0.429 [10.90]



Positronic
connectpositronic.com

PROFESSIONAL, INDUSTRIAL AND MILITARY QUALITY
THREE PERFORMANCE LEVELS FOR BEST COST/PERFORMANCE RATIO
STANDARD DENSITY PCB MOUNT

Combo-D
D-Sub

SOLDER CUP CONNECTOR CODE 2

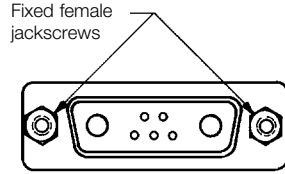
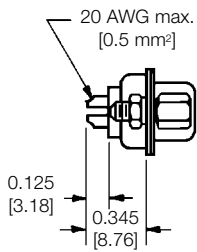

Fixed female jackscrews

For solder cup contacts, specify code 2 in step 4 of ordering information.

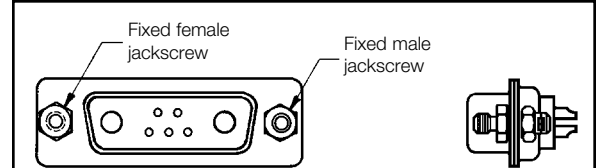

Fixed female jackscrew

Fixed male jackscrew

Fixed male and female polarized jackscrews available. Specify code T6 in step 7 of ordering information.

Typical part number: **CBD7W2M200T60**

Typical part number: **CBD7W2M200T0**

CBD/CBM SERIES



CBD17W2F200E0 with FS4008D contacts.

CBD17W2M55B30T20

STRAIGHT PRINTED BOARD MOUNT CONNECTOR CODE 3, 35, 36 AND 37

For Code 93 Press-Fit Board Mount Connectors, see page 20.

CONTACT CODE	D Ø
3	-----
35	0.078 [1.98]
36	0.094 [2.39]
37	0.125 [3.18]

For straight printed board mount contacts, specify code no. in step 4 of ordering information.

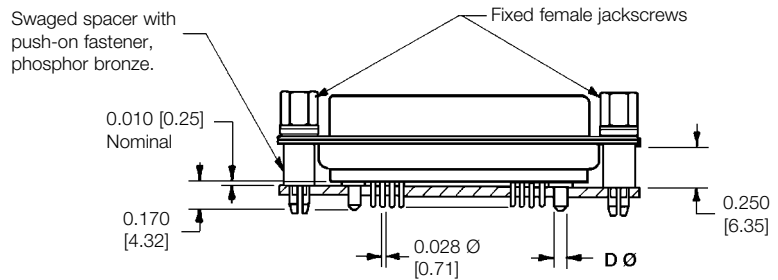

Typical part number: **CBD17W2F35S60T2X**



**RIGHT ANGLE (90°) PRINTED BOARD MOUNT CONNECTOR
WITH 0.078 [1.98] Ø POWER CONTACTS
CODE 5 AND 55, 0.283 [7.19] CONTACT EXTENSION**

See temperature rise curves on pages 1 and 2

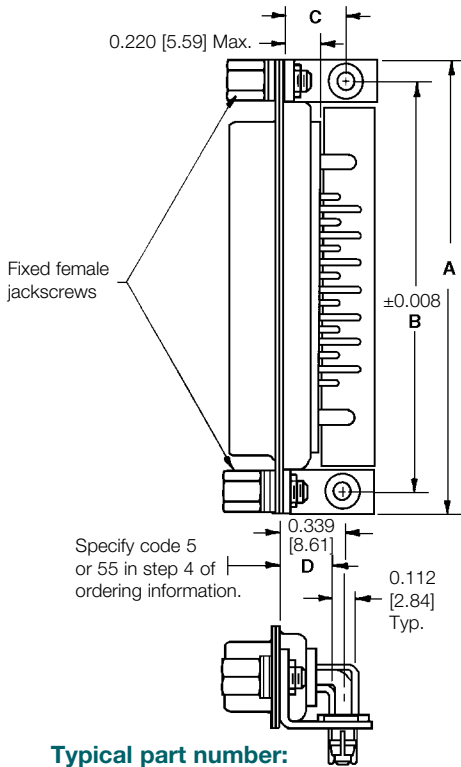

**Typical part number:
CBD17W2M55R7NT20**

CBD***R7*** 0.283 [7.19] CONTACT EXTENSION				
SHELL SIZE	A	B	C	D
SHELL SIZE 1	1.204 [30.58]	0.984 [24.99]	0.339 [8.61]	0.283 [7.19]
SHELL SIZE 2	1.532 [38.91]	1.312 [33.32]	0.339 [8.61]	0.283 [7.19]
SHELL SIZE 3	2.072 [52.63]	1.852 [47.04]	0.339 [8.61]	0.283 [7.19]
SHELL SIZE 4	2.720 [69.09]	2.500 [63.50]	0.339 [8.61]	0.283 [7.19]
SHELL SIZE 5	2.626 [66.70]	2.406 [61.11]	0.395 [10.03]	0.283 [7.19]

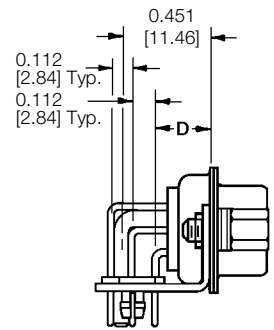
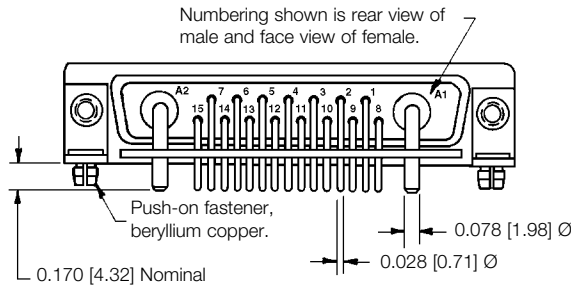

**Typical part number:
CBD36W4F55R7NT2X**

**RIGHT ANGLE (90°) PRINTED BOARD MOUNT CONNECTOR
WITH 0.125 [3.18] Ø POWER CONTACTS
CODE 5 AND 57, 0.283 [7.19] CONTACT EXTENSION**

See temperature rise curves on pages 1 and 2.

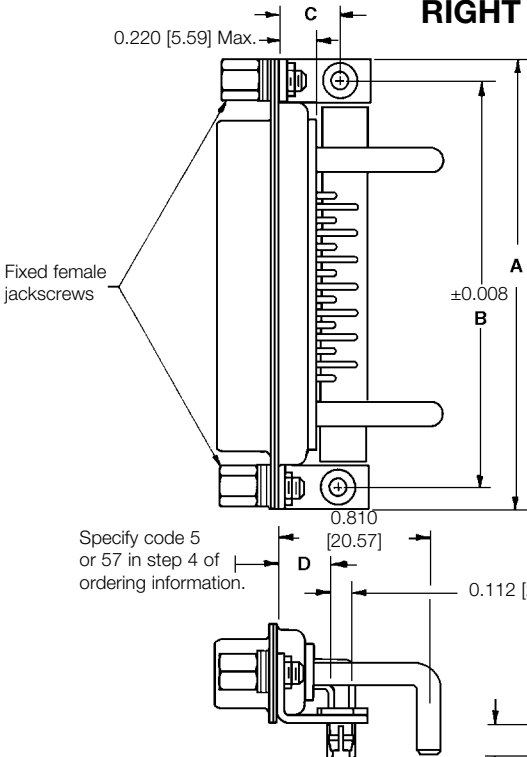

**Typical part number:
CBD17W2M57R7NT20**

CBD***R7*** 0.283 [7.19] CONTACT EXTENSION				
SHELL SIZE	A	B	C	D
SHELL SIZE 1	1.204 [30.58]	0.984 [24.99]	0.339 [8.61]	0.283 [7.19]
SHELL SIZE 2	1.532 [38.91]	1.312 [33.32]	0.339 [8.61]	0.283 [7.19]
SHELL SIZE 3	2.072 [52.63]	1.852 [47.04]	0.339 [8.61]	0.283 [7.19]
SHELL SIZE 4	2.720 [69.09]	2.500 [63.50]	0.339 [8.61]	0.283 [7.19]
SHELL SIZE 5	2.626 [66.70]	2.406 [61.11]	0.395 [10.03]	0.283 [7.19]

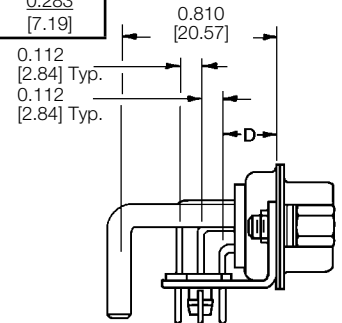
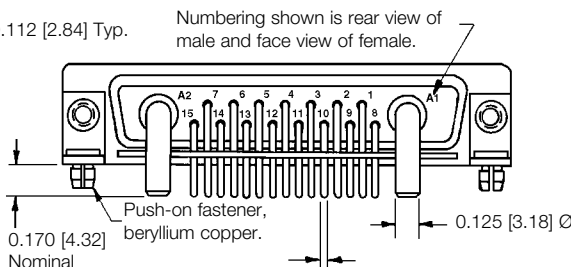

**Typical part number:
CBD36W4F57R7NT2X**



Positronic
connectpositronic.com

PROFESSIONAL, INDUSTRIAL AND MILITARY QUALITY
THREE PERFORMANCE LEVELS FOR BEST COST/PERFORMANCE RATIO
STANDARD DENSITY PCB MOUNT

Combo-D
D-Sub

CBD/CBM SERIES

SHELL SIZE 6
RIGHT ANGLE (90°) PRINTED BOARD MOUNT CONNECTOR
WITH 0.078 [1.98] Ø POWER CONTACTS

CODE 5 AND 55, 0.283 [7.19] CONTACT EXTENSION

CONNECTOR VARIANT 46W4

See temperature rise curves on pages 1 and 2

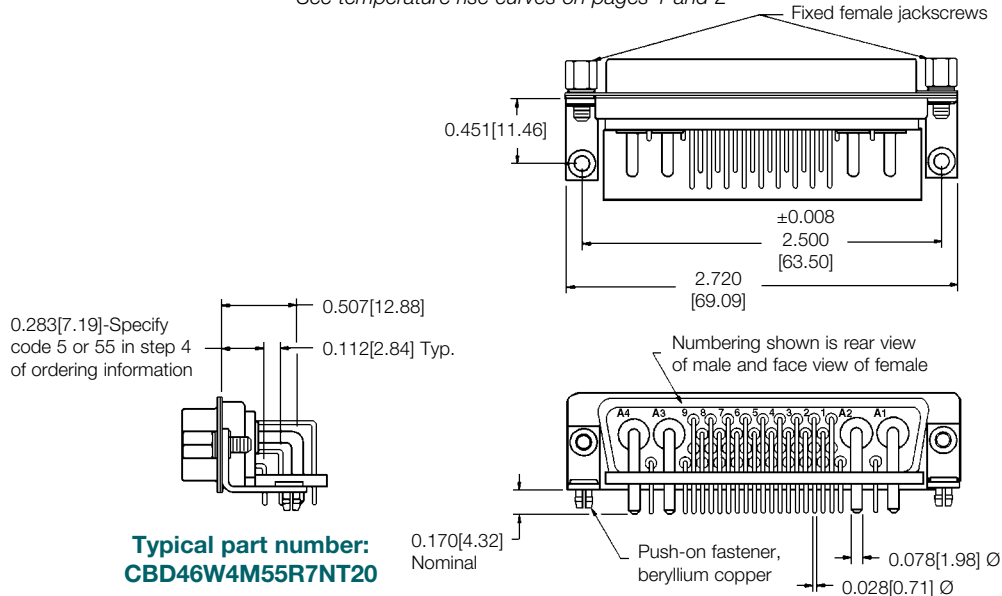

SHELL SIZE 6
RIGHT ANGLE (90°) PRINTED BOARD MOUNT CONNECTOR
WITH 0.125 [3.18] Ø POWER CONTACTS

CODE 5 OR 57, 0.283 [7.19] CONTACT EXTENSION

CONNECTOR VARIANT 46W4

See temperature rise curves on pages 1 and 2

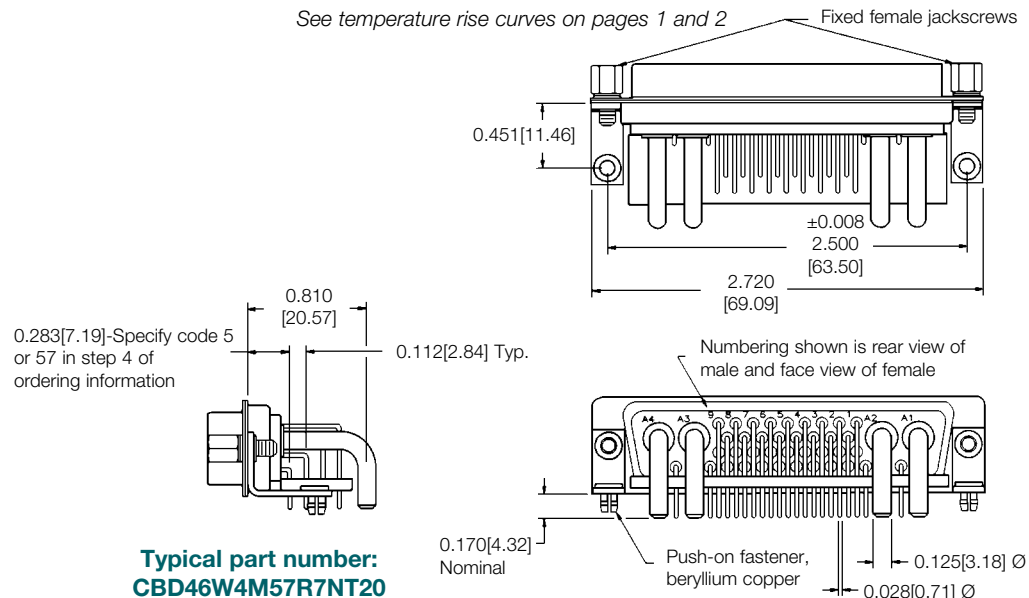



**METRIC SYSTEM RIGHT ANGLE (90°) PRINTED BOARD MOUNT CONNECTOR
WITH 0.078 [1.98] Ø POWER CONTACTS**

CODE 7 AND 75, 0.370 [9.40] CONTACT EXTENSION

See temperature rise curves on pages 1 and 2

CBD*R7*** 0.370 [9.40] CONTACT EXTENSION**

SHELL SIZE	A	B	C	D
SHELL SIZE 1	1.204 [30.58]	0.984 [24.99]	0.420 [10.67]	0.370 [9.40]
SHELL SIZE 2	1.532 [38.91]	1.312 [33.32]	0.420 [10.67]	0.370 [9.40]
SHELL SIZE 3	2.072 [52.63]	1.852 [47.04]	0.420 [10.67]	0.370 [9.40]
SHELL SIZE 4	2.720 [69.09]	2.500 [63.50]	0.420 [10.67]	0.370 [9.40]
SHELL SIZE 5	2.626 [66.70]	2.406 [61.11]	0.470 [11.94]	0.370 [9.40]

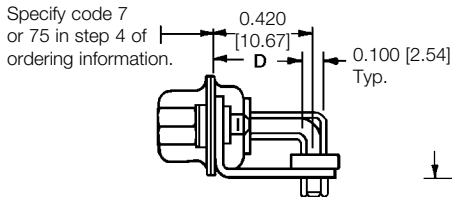
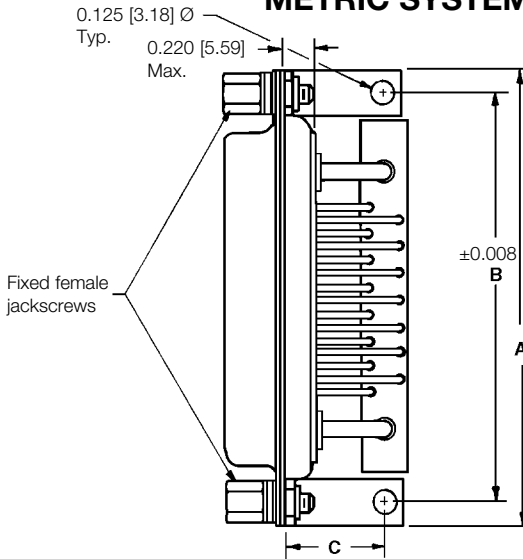

Typical part number:
CBD17W2M75R70T20

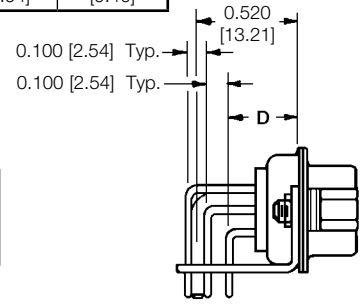
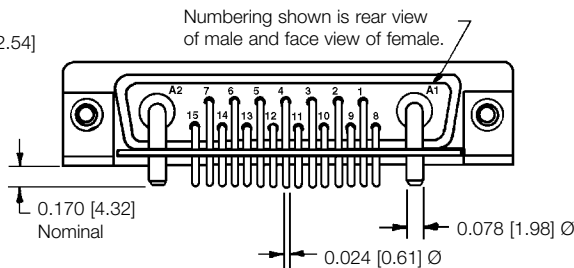

Typical part number:
CBD36W4M75R70T20

**METRIC SYSTEM RIGHT ANGLE (90°) PRINTED BOARD MOUNT CONNECTOR
WITH 0.125 [3.18] Ø POWER CONTACTS**

CODE 7 AND 77, 0.370 [9.40] CONTACT EXTENSION

See temperature rise curves on pages 1 and 2

CBD*R7*** 0.370 [9.40] CONTACT EXTENSION**

SHELL SIZE	A	B	C	D
SHELL SIZE 1	1.204 [30.58]	0.984 [24.99]	0.420 [10.67]	0.370 [9.40]
SHELL SIZE 2	1.532 [38.91]	1.312 [33.32]	0.420 [10.67]	0.370 [9.40]
SHELL SIZE 3	2.072 [52.63]	1.852 [47.04]	0.420 [10.67]	0.370 [9.40]
SHELL SIZE 4	2.720 [69.09]	2.500 [63.50]	0.420 [10.67]	0.370 [9.40]
SHELL SIZE 5	2.626 [66.70]	2.406 [61.11]	0.470 [11.94]	0.370 [9.40]

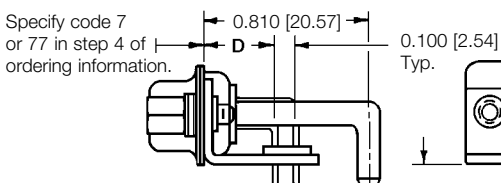
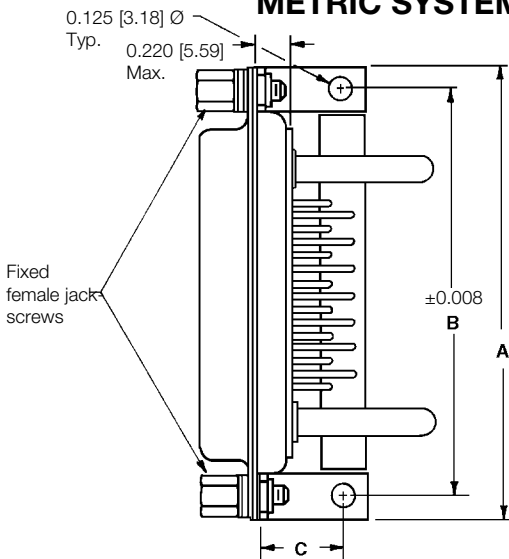

Typical part number:
CBD17W2M77R70T20

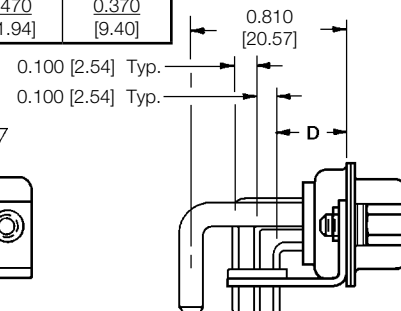
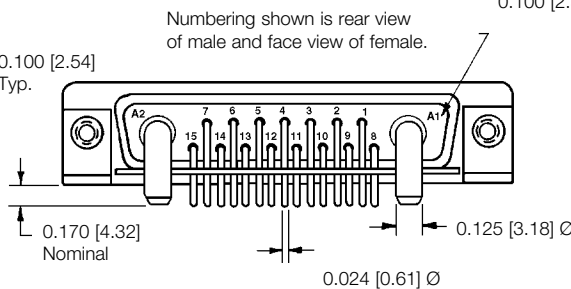

Typical part number:
CBD36W4M77R70T20



Positronic
connectpositronic.com

PROFESSIONAL, INDUSTRIAL AND MILITARY QUALITY
THREE PERFORMANCE LEVELS FOR BEST COST/PERFORMANCE RATIO
STANDARD DENSITY PCB MOUNT

Combo-D
D-Sub

RIGHT ANGLE (90°) PRINTED BOARD CONTACT HOLE PATTERN WITH 0.078 [1.98] Ø POWER CONTACTS AND STRAIGHT PRINTED BOARD CONTACT HOLE PATTERN WITH 0.078 [1.98] Ø, 0.094 [2.39] Ø AND 0.125 [3.18] Ø POWER CONTACTS

HOLE IDENTIFICATION SHOWN FOR MALE CONNECTOR; USE MIRROR IMAGE FOR FEMALE CONNECTOR.
MOUNT CONNECTOR WITH MATING FACE POSITIONED TO FOLLOW DIRECTION OF ARROWS.

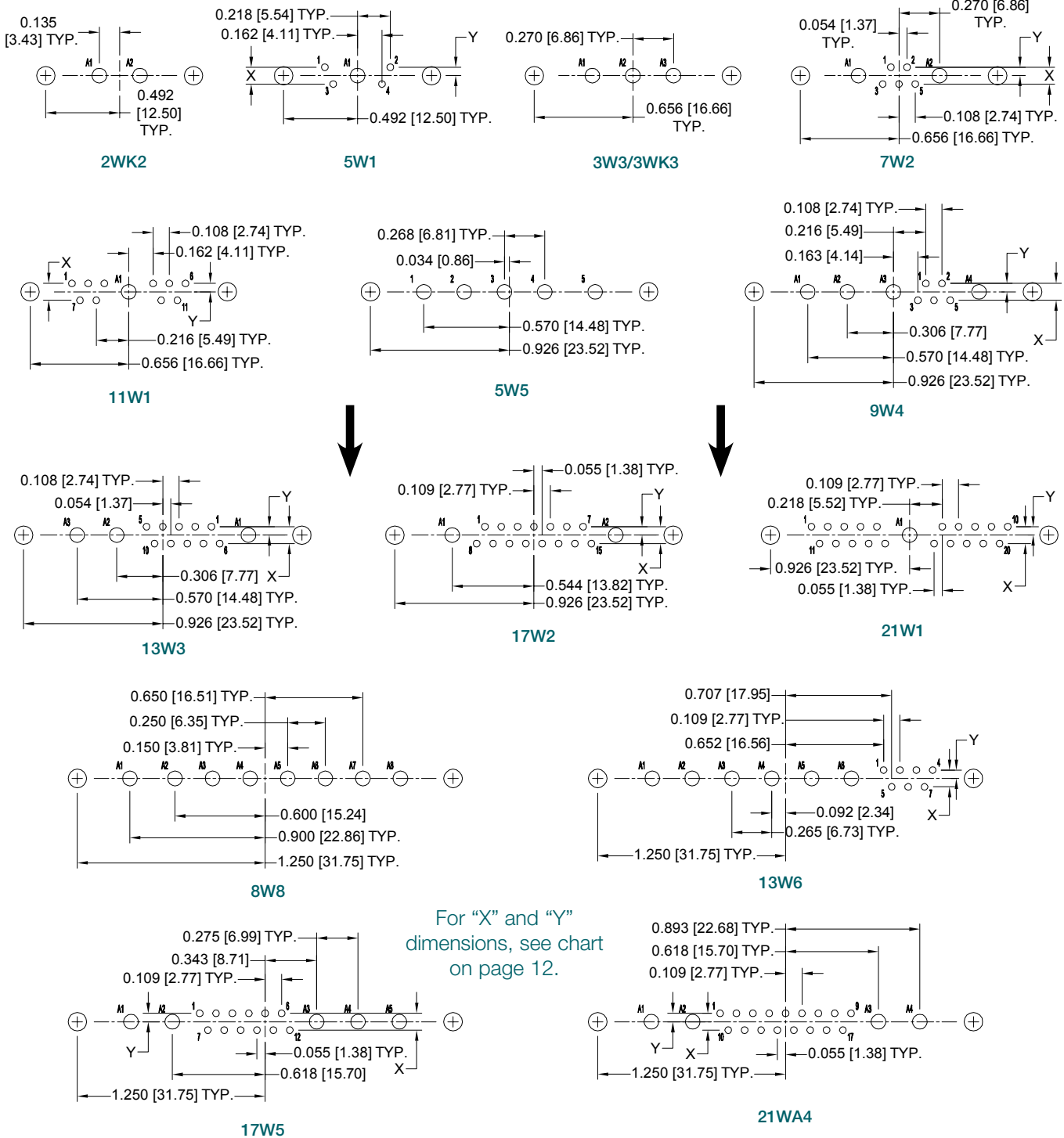

NOTE: For suggested printed board recommended drill hole sizes, plating and finished hole sizes for compliant contact termination positions, see page 86.

For press-fit connector installation tools, see page 86.

SUGGESTED PRINTED BOARD HOLE SIZES:

- Suggest 0.045 [1.14] Ø hole for signal contact termination positions.
- Suggest 0.098 [2.49] Ø hole for 0.078 [1.98] Ø power contact termination positions.
- Suggest 0.114 [2.90] Ø hole for 0.094 [2.39] Ø power contact termination positions.
- Suggest 0.145 [3.68] Ø hole for 0.125 [3.18] Ø power contact termination positions.
- Suggest 0.123 ±0.003 [3.12] Ø hole for mounting connector with push-on fasteners.

RIGHT ANGLE (90°) PRINTED BOARD CONTACT HOLE PATTERN WITH 0.078 [1.98] Ø POWER CONTACTS AND STRAIGHT PRINTED BOARD CONTACT HOLE PATTERN WITH 0.078 [1.98] Ø, 0.094 [2.39] Ø AND 0.125 [3.18] Ø POWER CONTACTS

HOLE IDENTIFICATION SHOWN FOR MALE CONNECTOR; USE MIRROR IMAGE FOR FEMALE CONNECTOR.
MOUNT CONNECTOR WITH MATING FACE POSITIONED TO FOLLOW DIRECTION OF ARROWS.

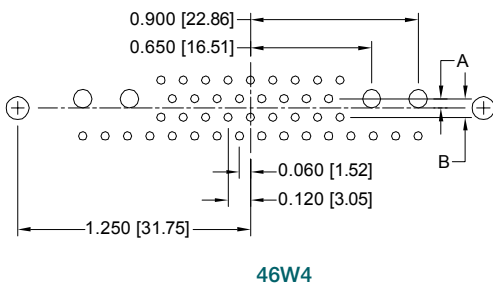
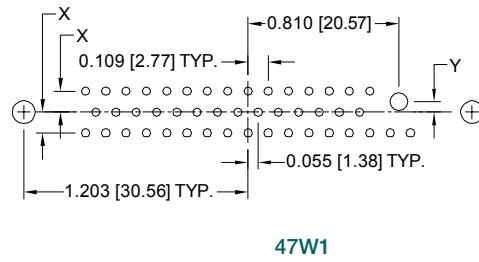
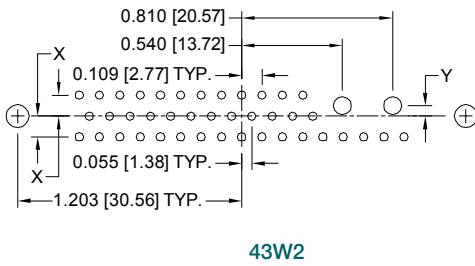
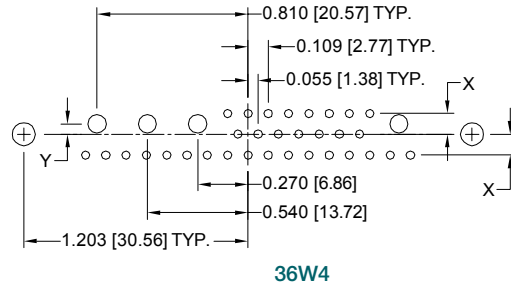
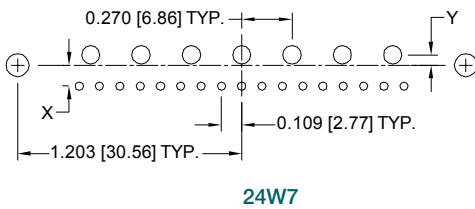
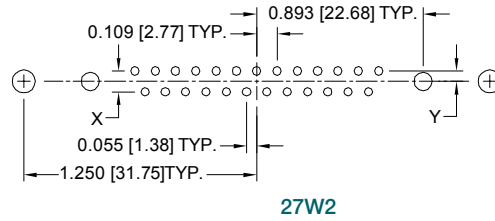
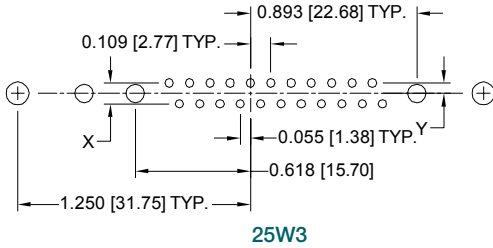

CODE NO.	X	Y	A	B
3				
35	0.112 [2.84]	0.056 [1.42]	0.050 [1.27]	0.100 [2.54]
36				
37				
5	0.112 [2.84]	0.056 [1.42]	0.056 [1.42]	0.112 [2.84]
55				
7	0.100 [2.54]	0.050 [1.27]	0.050 [1.27]	0.100 [2.54]
75				

SUGGESTED PRINTED BOARD HOLE SIZES:

- Suggest 0.045 [1.14] Ø hole for signal contact termination positions.
- Suggest 0.098 [2.49] Ø hole for 0.078 [1.98] Ø power contact termination positions.
- Suggest 0.114 [2.90] Ø hole for 0.094 [2.39] Ø power contact termination positions.
- Suggest 0.145 [3.68] Ø hole for 0.125 [3.18] Ø power contact termination positions.
- Suggest 0.123 ±0.003 [3.12] Ø hole for mounting connector with push-on fasteners.

NOTE: For suggested printed board recommended drill hole sizes, plating and finished hole sizes for compliant contact termination positions, see page 85.

For press-fit connector installation tools, see page 86.



Positronic
connectpositronic.com

PROFESSIONAL, INDUSTRIAL AND MILITARY QUALITY
THREE PERFORMANCE LEVELS FOR BEST COST/PERFORMANCE RATIO
STANDARD DENSITY PCB MOUNT

Combo-D
D-Sub

RIGHT ANGLE (90°) PRINTED BOARD CONTACT HOLE PATTERN
WITH 0.125 [3.18] Ø POWER CONTACTS

HOLE IDENTIFICATION SHOWN FOR MALE CONNECTOR; USE MIRROR IMAGE FOR FEMALE CONNECTOR.
MOUNT CONNECTOR WITH MATING FACE POSITIONED TO FOLLOW DIRECTION OF ARROWS.

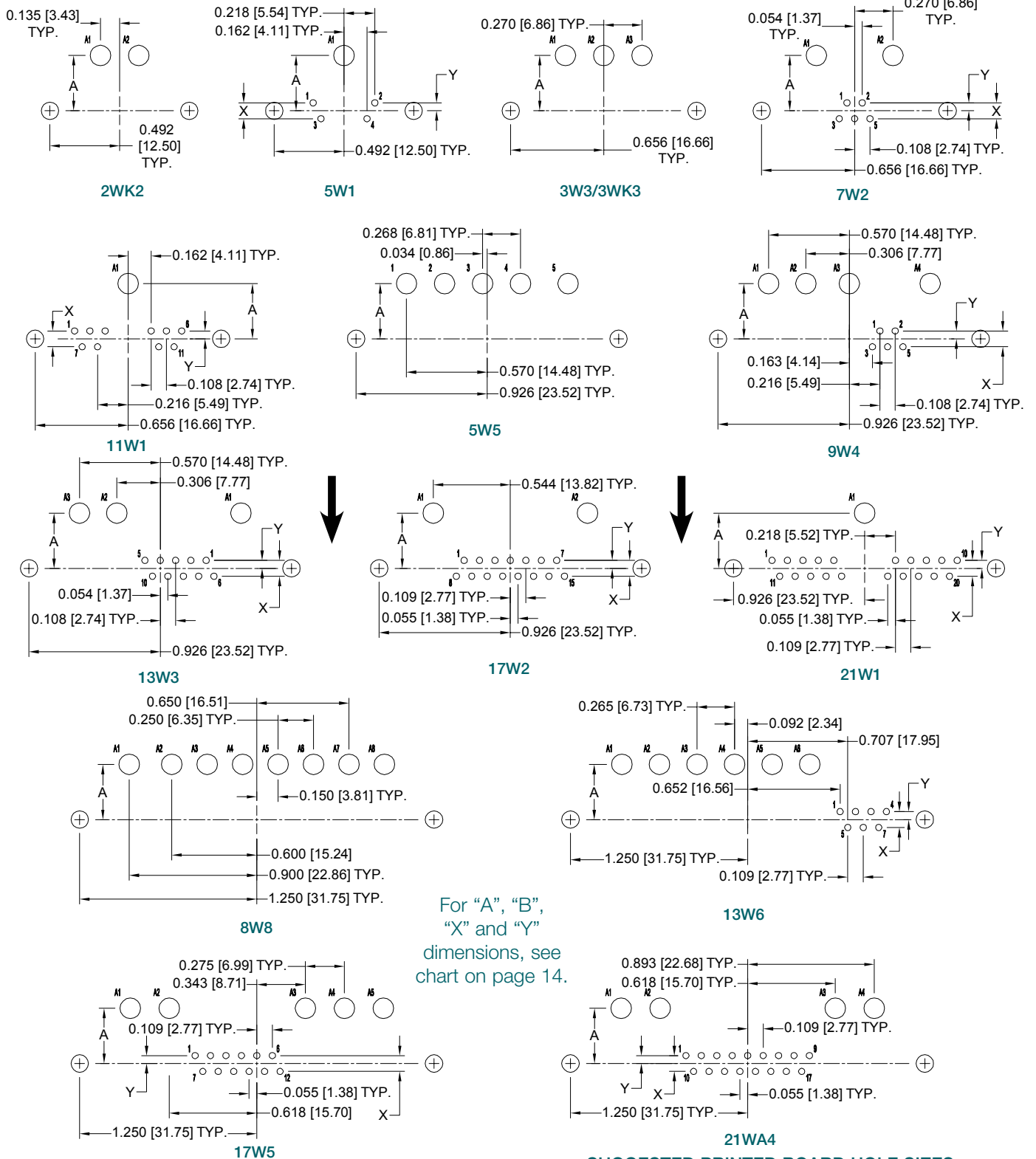

For "A", "B",
"X" and "Y"
dimensions, see
chart on page 14.

SUGGESTED PRINTED BOARD HOLE SIZES:

Suggest 0.045 [1.14] Ø hole for signal contact termination positions.
Suggest 0.145 [3.68] Ø hole for power contact termination positions.
Suggest 0.123±0.003 [3.12] Ø hole for mounting connector with push-on fasteners.



**RIGHT ANGLE (90°) PRINTED BOARD CONTACT HOLE PATTERN
WITH 0.125 [3.18] Ø POWER CONTACTS**

HOLE IDENTIFICATION SHOWN FOR MALE CONNECTOR; USE MIRROR IMAGE FOR FEMALE CONNECTOR.
MOUNT CONNECTOR WITH MATING FACE POSITIONED TO FOLLOW DIRECTION OF ARROWS.

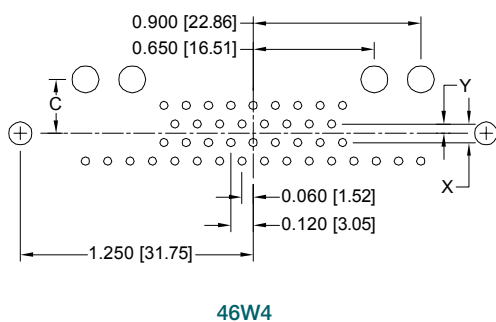
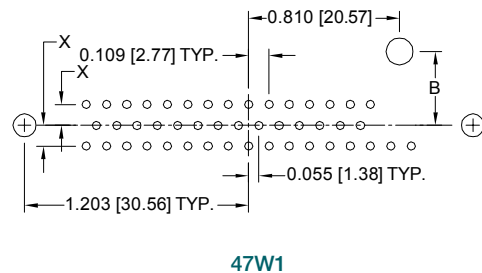
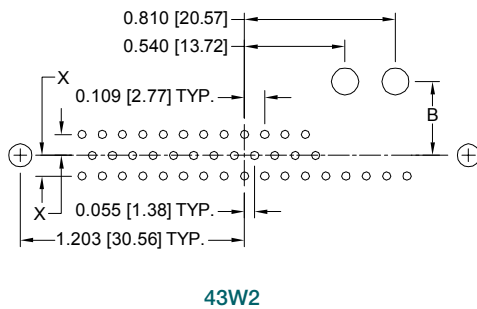
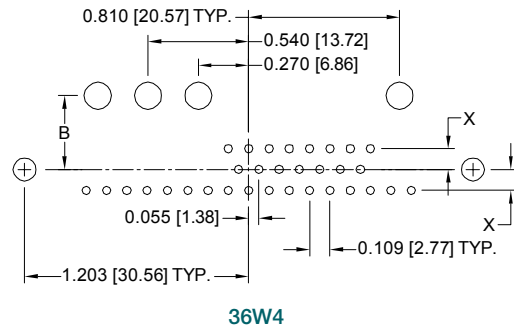
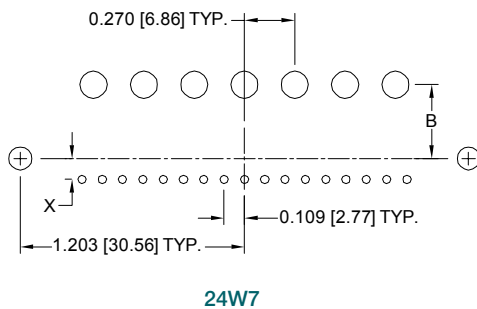
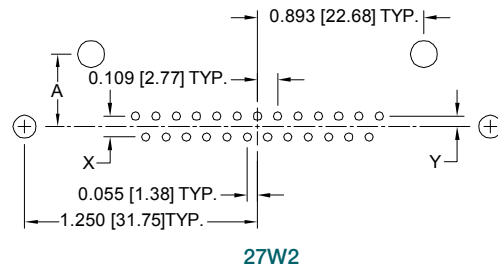
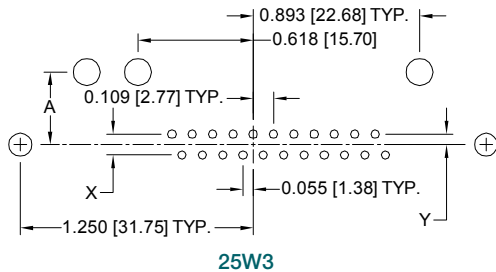

CODE NO.	5 & 57	7 & 77
A	0.471 [11.96]	0.390 [9.91]
B	0.415 [10.54]	0.340 [8.64]
C	0.359 [9.12]	0.290 [7.37]
X	0.112 [2.84]	0.100 [2.54]
Y	0.056 [1.42]	0.050 [1.27]

SUGGESTED PRINTED BOARD HOLE SIZES:

Suggest 0.045 [1.14] Ø hole for signal contact termination positions.
Suggest 0.145 [3.68] Ø hole for power contact termination positions.
Suggest 0.123±0.003 [3.12] Ø hole for mounting connector with push-on fasteners.

**DIMENSIONS ARE IN INCHES [MILLIMETERS].
ALL DIMENSIONS ARE SUBJECT TO CHANGE. 14**



Positronic
connectpositronic.com

PROFESSIONAL, INDUSTRIAL AND MILITARY QUALITY
THREE PERFORMANCE LEVELS FOR BEST COST/PERFORMANCE RATIO
STANDARD DENSITY PCB MOUNT

Combo-D
D-Sub

**STRAIGHT PRINTED BOARD MOUNT CONNECTOR
WITH FDS4201D OR MDS4201D SHIELDED CONTACTS
CODE 65**

Typical part number:
CBD17W2M65S60T20

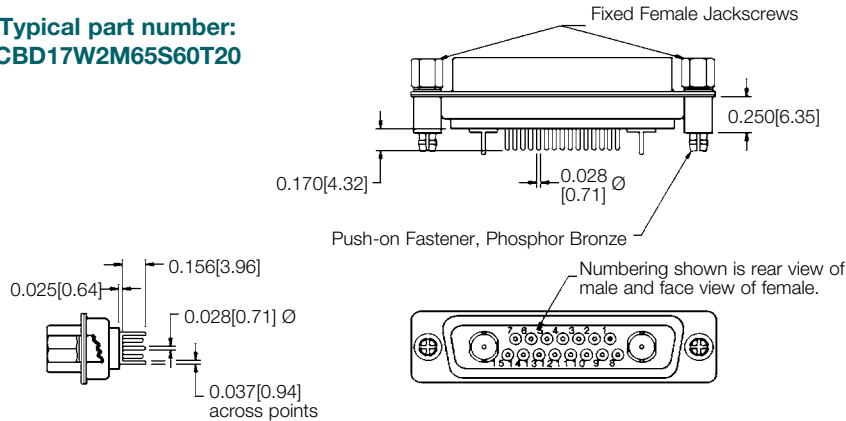

**RIGHT ANGLE (90°) PRINTED BOARD MOUNT CONNECTOR
WITH FRT4201D OR MRT4201D SHIELDED CONTACTS
CODE 85**

CBD**85**** 0.283 [7.19] CONTACT EXTENSION				
SHELL SIZE	A	B	C	D
SHELL SIZE 1	1.204 [30.58]	0.984 [24.99]	0.339 [8.61]	0.283 [7.19]
SHELL SIZE 2	1.532 [38.91]	1.312 [33.32]	0.339 [8.61]	0.283 [7.19]
SHELL SIZE 3	2.072 [52.63]	1.852 [47.04]	0.339 [8.61]	0.283 [7.19]
SHELL SIZE 4	2.720 [69.09]	2.500 [63.50]	0.339 [8.61]	0.283 [7.19]
**SHELL SIZE 5	2.626 [66.70]	2.406 [61.11]	0.395 [10.03]	0.545 [13.84]

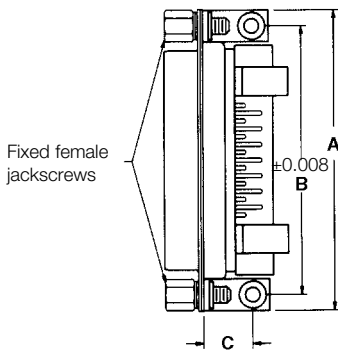

***NOTE:**
Shell size 5 connectors are supplied inverted when ordered with right angle (90°) printed board mount shielded contacts.

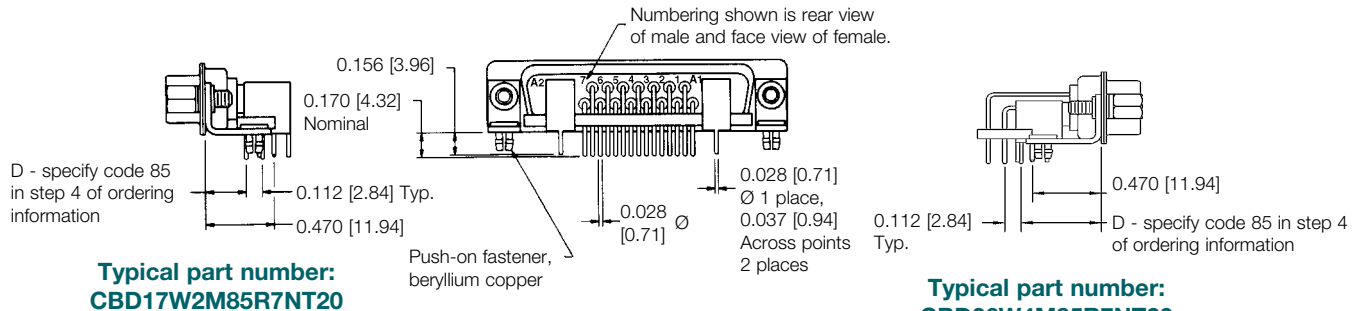



**STRAIGHT PRINTED BOARD MOUNT CONTACT HOLE PATTERN
WITH FDS4201D AND MDS4201D SHIELDED CONTACTS**

HOLE IDENTIFICATION SHOWN FOR MALE CONNECTOR; USE MIRROR IMAGE FOR FEMALE CONNECTOR.

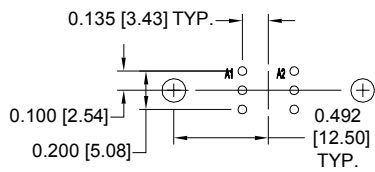

2WK2

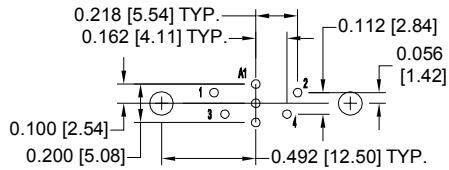

5W1

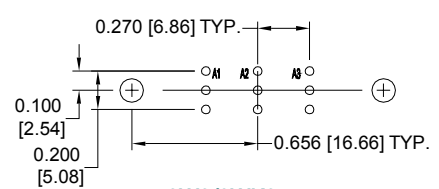

3W3/3WK3

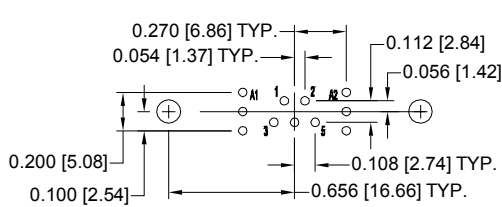

7W2

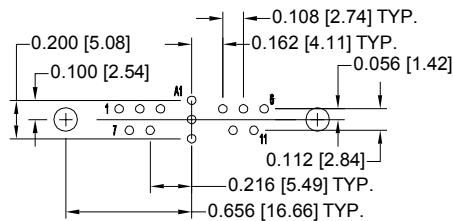

11W1

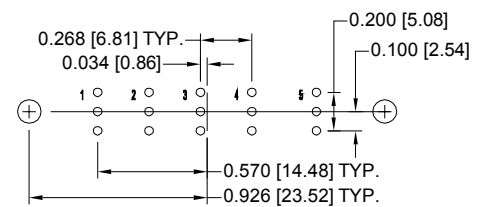

5W5

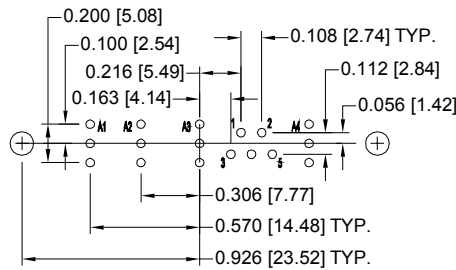

9W4

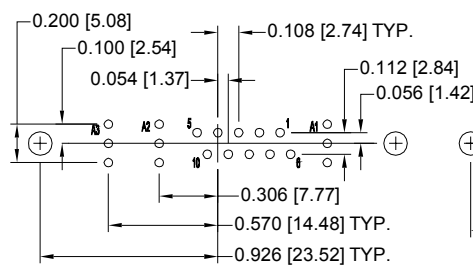

13W3

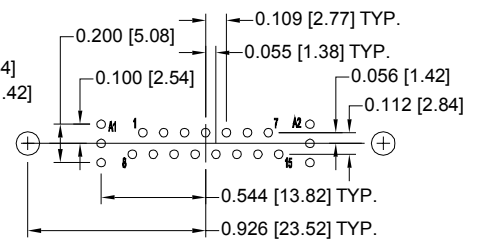

17W2

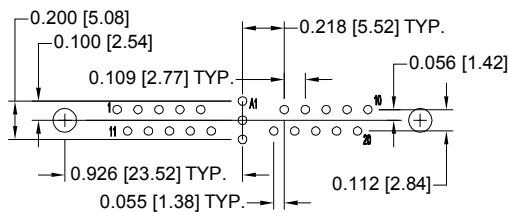

21W1

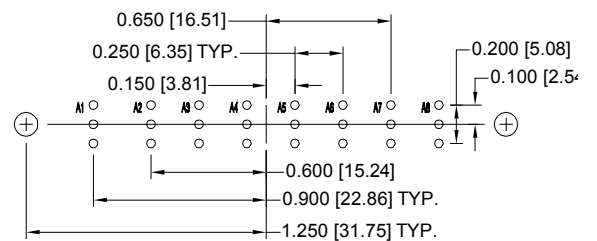

8W8

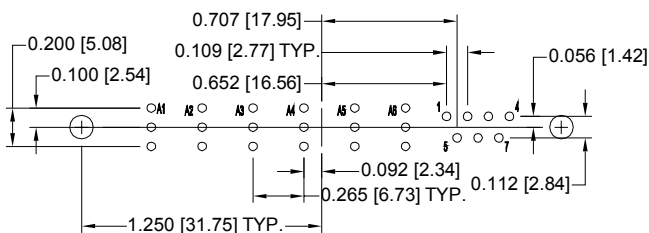

13W6

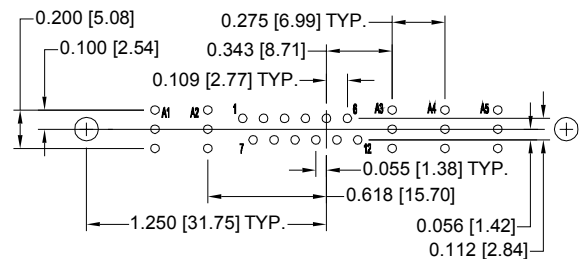

17W5

SUGGESTED PRINTED BOARD HOLE SIZES:

Suggest 0.045 [1.14] Ø hole for signal contact termination position.
Suggest 0.123±0.003 [3.12] Ø hole for mounting connector with push-on fasteners.



Positronic
connectpositronic.com

PROFESSIONAL, INDUSTRIAL AND MILITARY QUALITY
THREE PERFORMANCE LEVELS FOR BEST COST/PERFORMANCE RATIO
STANDARD DENSITY PCB MOUNT

Combo-D
D-Sub

STRAIGHT PRINTED BOARD MOUNT CONTACT HOLE PATTERN
WITH FDS4201D AND MDS4201D SHIELDED CONTACTS

HOLE IDENTIFICATION SHOWN FOR MALE CONNECTOR; USE MIRROR IMAGE FOR FEMALE CONNECTOR.

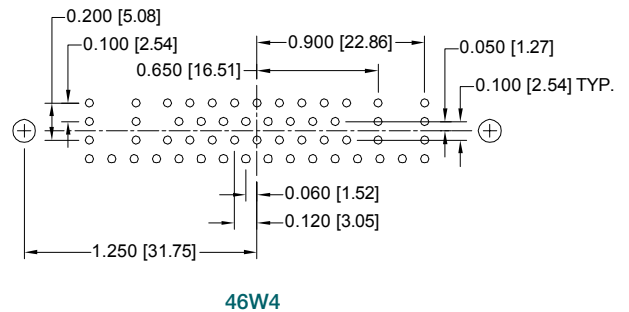
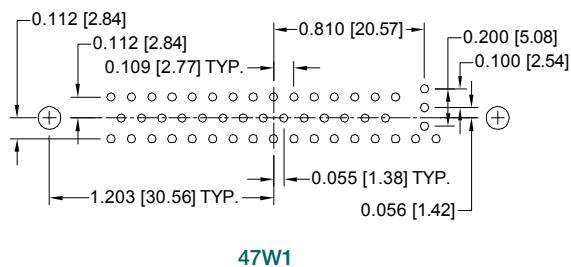
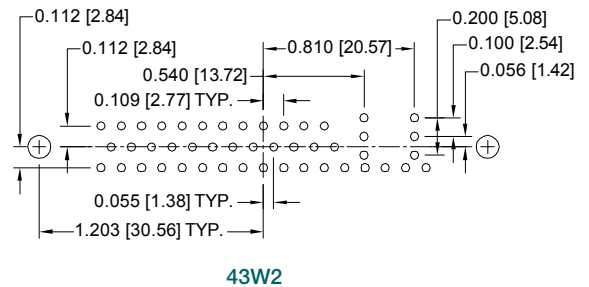
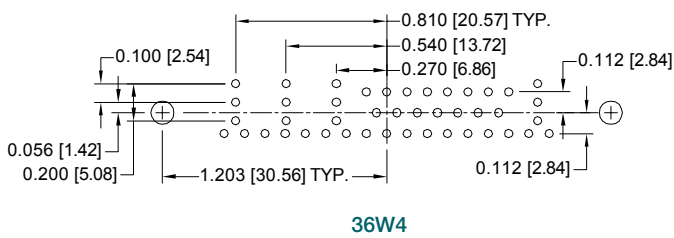
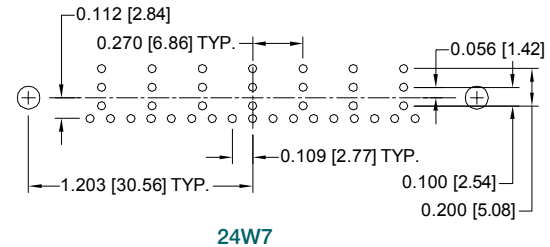
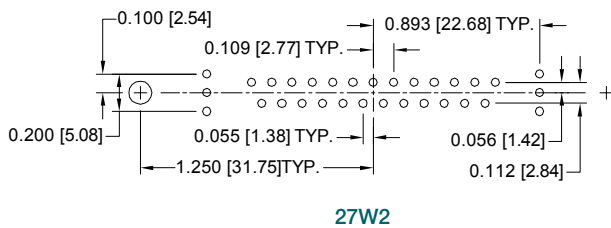
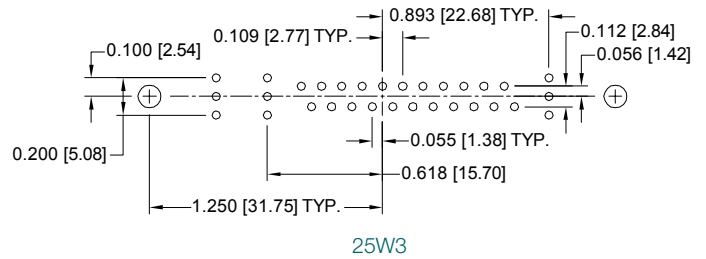
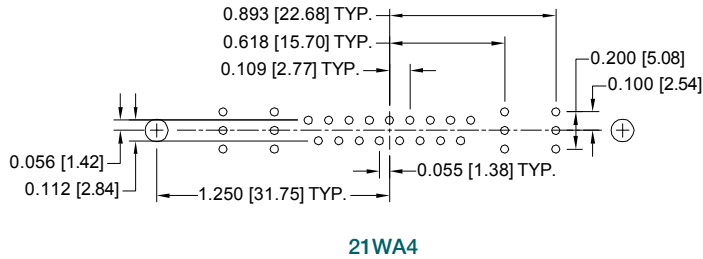

SUGGESTED PRINTED BOARD HOLE SIZES:

Suggest 0.045 [1.14] Ø hole for signal contact termination position.
Suggest 0.123±0.003 [3.12] Ø hole for mounting connector with push-on fasteners.



**RIGHT ANGLE (90°) PRINTED BOARD MOUNT CONTACT HOLE PATTERN
WITH FRT4201D AND MRT4201D SHIELDED CONTACTS**

HOLE IDENTIFICATION SHOWN FOR MALE CONNECTOR; USE MIRROR IMAGE FOR FEMALE CONNECTOR.
MOUNT CONNECTOR WITH MATING FACE POSITIONED TO FOLLOW DIRECTION OF ARROWS.

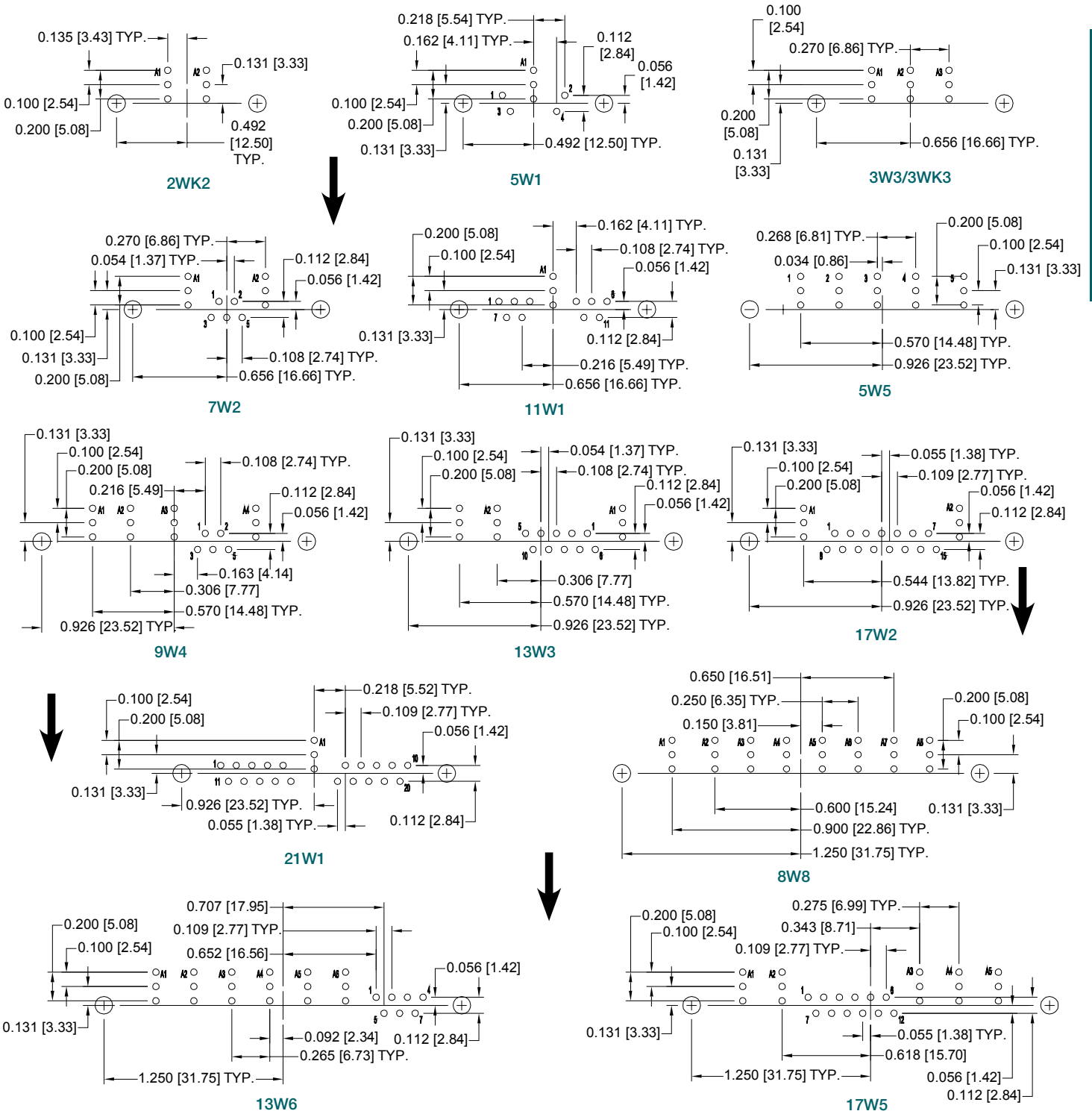

SUGGESTED PRINTED BOARD HOLE SIZES:

Suggest 0.045 [1.14] Ø hole for signal contact termination position.
Suggest 0.123±0.003 [3.12] Ø hole for mounting connector with push-on fasteners.



RIGHT ANGLE (90°) PRINTED BOARD MOUNT CONTACT HOLE PATTERN WITH FRT4201D AND MRT4201D SHIELDED CONTACTS

HOLE IDENTIFICATION SHOWN FOR MALE CONNECTOR; USE MIRROR IMAGE FOR FEMALE CONNECTOR.
MOUNT CONNECTOR WITH MATING FACE POSITIONED TO FOLLOW DIRECTION OF ARROWS.

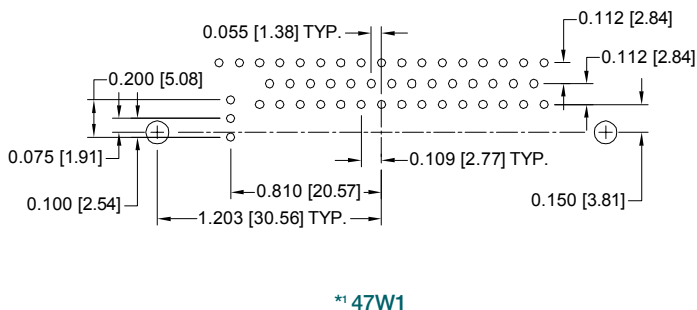
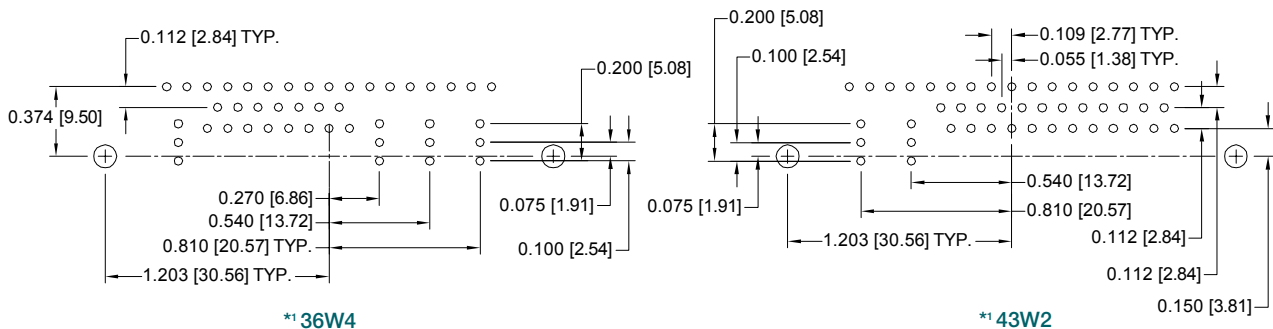
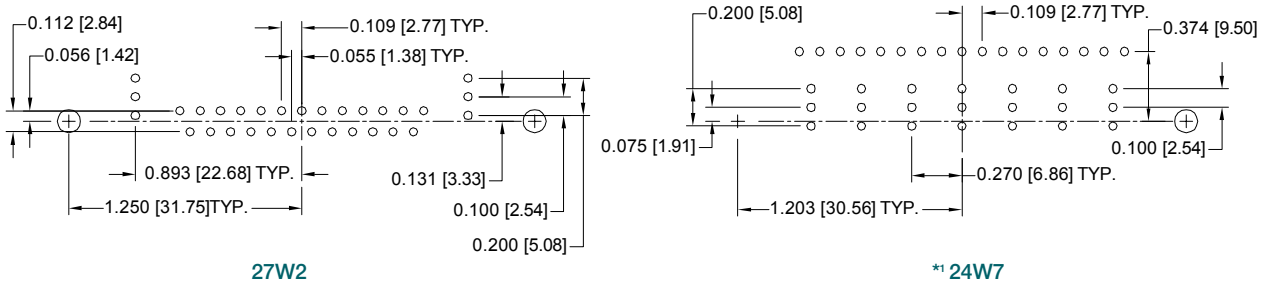
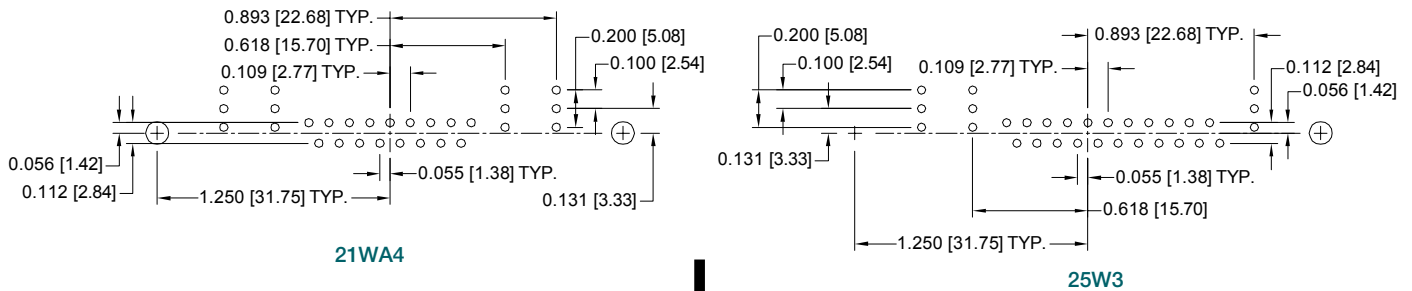

***1 NOTE:**

Shell size 5 connectors are supplied inverted when ordered with right angle (90°) printed board mount shielded contacts.

SUGGESTED PRINTED BOARD HOLE SIZES:

Suggest 0.045 [1.14] Ø hole for signal contact termination position.
Suggest 0.123±0.003 [3.12] Ø hole for mounting connector with push-on fasteners.



**COMPLIANT PRESS-FIT CONNECTOR
CODE 93**

Positronic recommends the practice of using mounting hardware to secure connector to printed circuit board.

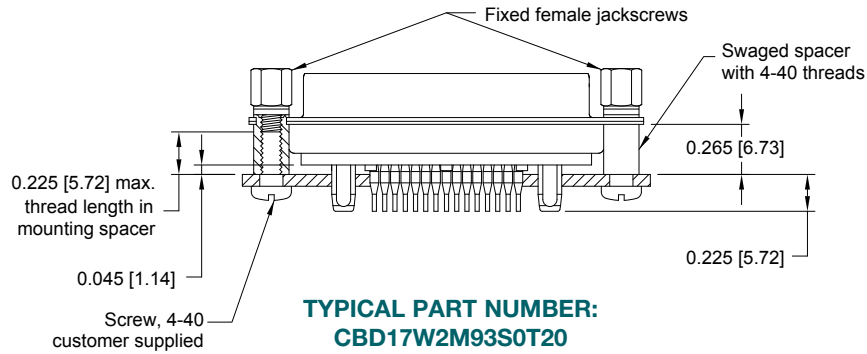

SUGGESTED PRINTED BOARD HOLE SIZES:

Suggest 0.123 [3.12] Ø hole for connector mounting holes.

NOTE: For suggested printed board recommended drill hole sizes, plating and finished hole sizes for compliant contact termination positions, see page 85.

For press-fit connector installation tools, see page 86.

FOR STRAIGHT PRINTED BOARD
CONTACT HOLE PATTERNS,
SEE PAGES 11 AND 12.

TEMPERATURE RISE CURVE

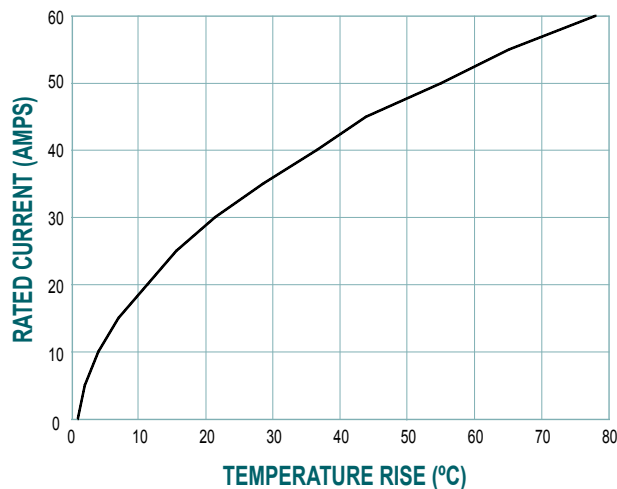

Test conducted in accordance with UL1977.

All power contacts under load.

Curve developed using CBD8W8M00000 and CBD8W8F93S000 connectors with MC4008D contacts terminated to 8 AWG wire.



Positronic
connectpositronic.com

PROFESSIONAL, INDUSTRIAL AND MILITARY QUALITY
THREE PERFORMANCE LEVELS FOR BEST COST/PERFORMANCE RATIO
STANDARD DENSITY PCB MOUNT

Combo-D
D-Sub

ORDERING INFORMATION - CODE NUMBERING SYSTEM

Specify Complete Connector By Selecting An Option From Step 1 Through 8

STEP	1	2	3	4	5	6	7	8	9	10
EXAMPLE	CBD	17W2	F	55	R7	N	T2	X	/AA	-14

STEP 1 - BASIC SERIES

CBD – Professional/Industrial Quality, see Step 3.
CBM – Military conformance with "closed entry" female signal contacts plated 0.000050 [1.27µ] gold over nickel plate. Choose "S" or "M" in Step 3.

STEP 2 - CONNECTOR VARIANTS

Shell Size 1 - 2WK2, 5W1
Shell Size 2 - 3W3, 3WK3, 7W2, 11W1
Shell Size 3 - 5W5, 9W4, 13W3, 17W2, 21W1
Shell Size 4 - 8W8, 13W6, 17W5, 21WA4, 25W3, 27W2
Shell Size 5 - 24W7, 36W4, 43W2, 47W1
Shell Size 6 - 46W4

STEP 3 - CONNECTOR GENDER

F - Female - Professional Level - Open Entry Signal Contacts
M - Male
S - Female - Industrial / Military Level - PosiBand Closed Entry Signal Contacts

STEP 4 - CONTACT TERMINATION TYPE

- 0 - Connector ordered without size 8 power, shielded, air or high voltage removable contacts. See pages 60-88 for contact part numbers. Available on 2WK2, 3W3, 3WK3, 5W5 and 8W8.
- 2 - Fixed Solder Cup, Signal Contacts only.
- 3 - Solder, Straight Printed Board Mount with Signal Contacts, 0.170 [4.32] Tail Length.
- 35 - Solder, Straight Printed Board Mount with Signal and 0.078 [1.98] Ø Power Contacts, 0.170 [4.32] Tail Length.
- 36 - Solder, Straight Printed Board Mount with Signal and 0.094 [2.39] Ø Power Contacts, 0.170 [4.32] Tail Length.
- 37 - Solder, Straight Printed Board Mount with Signal and 0.125 [3.18] Ø Power Contacts, 0.170 [4.32] Tail Length.
- 5 - Solder, Right Angle (90°) Printed Board Mount with Signal Contacts only, 0.283 [7.19] Signal Contact Extension.
- 55 - Solder, Right Angle (90°) Printed Board Mount with Signal and 0.078 [1.98] Ø Power Contacts, 0.283 [7.19] Signal Contact Extension.
- 57 - Solder, Right Angle (90°) Printed Board Mount with Signal and 0.125 [3.18] Ø Power Contacts, 0.283 [7.19] Signal Contact Extension.
- 65 - Solder, Straight Printed Board Mount with Signal and Shielded Contacts MDS/FDS 4201D footprint, 0.170 [4.32] Signal Contact Tail Length.
- 7 - Solder, Metric System Right Angle (90°) Printed Board Mount with Signal Contacts only, 0.370 [9.40] Signal Contact Extension.
- 75 - Solder, Metric System Right Angle (90°) Printed Board Mount with Signal and 0.078 [1.98] Ø Power Contacts, 0.370 [9.40] Signal Contact Extension.
- 77 - Solder, Metric System Right Angle (90°) Printed Board Mount with Signal and 0.125 [3.18] Ø Power Contacts, 0.370 [9.40] Signal Contact Extension.
- *1 85 - Solder, Right Angle (90°) Printed Board Mount with Signal and Shielded Contacts MRT/FRT 4201D footprint, 0.283 [7.19] Signal Contact Extension.
- 93 - Size 20 Omega type compliant and Size 8 Bi-Spring type compliant, termination length 0.225 [5.72].

NOTES

- *1 Not available on shell size 6, CBD 46W4.
- *2 For additional information on accessories listed in steps 5, 6, 7 and 10, see Accessory Catalog.
- *3 When using G hood with CBD variants, use the extended height hood. See Accessories Catalog for extended G hood options.
- *4 For stainless steel dimpled male versions, contact Technical Sales.
- *5 Not available when using 2WK2, 3W3, 3WK3, 5W5, 8W8, instead use B, R, R3, R4, or R5.

21 DIMENSIONS ARE IN INCHES [MILLIMETERS]. ALL DIMENSIONS ARE SUBJECT TO CHANGE.

***2 STEP 10 - SPECIAL OPTIONS**

FOR SPECIAL OPTIONS, SEE SPECIAL OPTIONS APPENDIX ON PAGE 81.

CONTACT TECHNICAL SALES FOR ORDERING DETAILS OF THE FOLLOWING:

Other Special Requirements.
Straight / Right Angle Thermocouple PCB mount contacts.

STEP 9 - ENVIRONMENTAL COMPLIANCE OPTIONS

/AA - RoHS Compliant

NOTE: If compliance to environmental legislation is not required, this step will not be used. Example: CBD17W2F55R7NT2X

STEP 8 - SHELL OPTIONS

- 0 - Zinc Plated, with Chromate Seal.
- **S - Stainless Steel, passivated.
- X - Tin Plated.
- Z - Tin Plated and Dimpled (male connectors only).

***2 STEP 7 - LOCKING AND POLARIZING SYSTEMS**

- 0 - None.
- V3 - Lock Tab, connector front panel mounted.
- V5 - Lock Tab, connector rear panel mounted.
- VL - Lock Lever, used with Hoods only.
- T - Fixed Female Jackscrews.
- T2 - Fixed Female Jackscrews.
- T6 - Fixed Male and Female Polarized Jackscrews.
- E - Rotating Male Jackscrews.
- E2 - Rotating Male Screw Locks.
- E3 - Rotating Male with Internal Hex for 3/32 Hex Drives
- E6 - Rotating Male and Female Polarized Jackscrews.

***2 STEP 6 - HOODS AND PUSH-ON FASTENERS**

- 0 - None
- AN - Lightweight Aluminum Hood, nickel finish.
- AC - Lightweight Aluminum Hood, no finish.
- Z - Hood, Top or Side Opening, robust extended height, plastic and composite, with rotating male jackscrews, shell sizes 1 through 5
- H - Hood, Top Opening, Metal, shell sizes 2 through 5
- *3 G - Hood, EMI/RFI, Die Cast Zinc, shell sizes 1 through 6
- N - Push-on Fastener, for Right Angle (90°) Mounting Brackets

***2 STEP 5 - MOUNTING STYLE**

- 0 - Mounting Hole, 0.120 [3.05] Ø
- 02 - Mounting Hole, 0.154 [3.91] Ø
- *5 B3 - Bracket, Mounting, Right Angle (90°) Metal with Cross Bar
- *5 B8 - Bracket, Mounting, Right Angle (90°) Plastic with Cross Bar
- F - Float Mounts, Universal
- P - Threaded Post, Brass, 0.250 [6.35] Length
- P2 - Threaded Post, Nylon, 0.250 [6.35] Length
- *5 R2 - Bracket, Mounting, Right Angle (90°) Metal, Swaged to Connector with 4-40 Thread Fixed Female Jackscrews with Cross Bar
- *5 R6 - Bracket, Mounting, Right Angle (90°) Metal, Swaged to Connector with 0.120 [3.05] Ø Mounting Hole with Cross Bar
- *5 R7 - Bracket, Mounting, Right Angle (90°) Metal, Swaged to Connector with 4-40 Threads with Cross Bar
- *5 R8 - Bracket, Mounting, Right Angle (90°) Metal, Swaged to Connector with 4-40 Locknut with Cross Bar
- S - Swaged Spacer, 4-40 Threads, 0.250 [6.35] Length, Spacer length changes to 0.265 [6.73] when used in conjunction with Code 93 contacts
- S2 - Swaged Spacer, 4-40 Threads, 0.125 [3.18] Length
- S5 - Swaged Locknut, 4-40 Threads
- S6 - Swaged Spacer with Push-on Fastener, 4-40 Threads, 0.250 [6.35] Length



Size 20 Removable Signal and
Thermocouple Crimp Contacts

Size 8 Removable Power, Shielded,
Air and High Voltage Contacts

DSCC 85039

IEC 60807-3

UL Recognized
File #E49351

CSA Recognized
File #LR54219

Telecommunication UL File #E140980



CBC series connectors offer professional, industrial and military performance levels. Connectors are designed for use in sheltered, mildly corrosive environments having a wide range of temperature, pressure and humidity changes. CBC series connectors offer mixed crimp-removable contact combinations of power, shielded, air, high voltage, signal, and thermocouple contacts within the same connector body. Refer to size 8 removable contacts power, shielded, air and high voltage section, pages 68-80 for technical characteristics. Sixteen connector variants are offered in six standard shell sizes.

A wide assortment of cable support hoods and locking systems is available from stock.

CBC series connectors also offer a Blind Mating connector system for applications requiring connector couplings in recessed areas or for mobile power coupling systems.

CBC series connectors utilize precision machined contacts and they meet the applicable performance and dimensional requirements of IEC 60807-3, Performance Levels One and Two, DSCC 85039 and MIL-DTL-24308.

CBC SERIES

Connectors Designed To Customer Specifications

Positronic Combo-D connectors can be modified to customers specifications.

Examples: select loading of contacts for cost savings or to gain creepage and clearance distances; longer PCB terminations; customer specified hardware; sealing for water resistance.

Contact Technical Sales with your particular requirements.



Positronic
connectpositronic.com

**PROFESSIONAL, INDUSTRIAL AND MILITARY QUALITY
THREE PERFORMANCE LEVELS FOR BEST COST/PERFORMANCE RATIO
STANDARD DENSITY CRIMP REMOVABLE CONTACTS**

**Combo-D
D-Sub**

TECHNICAL CHARACTERISTICS

MATERIALS AND FINISHES:

Insulator: Glass filled polyester per ASTM D 5927, UL 94V-0, blue color.

Contacts: Precision machined copper alloy.

SIGNAL: Gold flash over nickel plate and gold 0.000050 [1.27µ] over nickel plate. Other finishes available upon request, see page 81.

POWER: Gold flash over nickel. Other finishes available upon request, see page 81.

SHIELDED: For contact platings, see page 68.

HIGH VOLTAGE: For contact platings, see page 68.

Shells: Steel with tin plate; zinc plate with chromate seal; stainless steel passivated. Other materials and finishes available upon request.

Mounting Spacers: Nylon; copper alloy or steel with zinc plate and chromate seal or tin plate; phosphor bronze with tin plate; stainless steel, passivated.

Jackscrew Systems: Brass or steel with zinc plate and chromate seal or clear zinc plate or tin plate; stainless steel, passivated.

Hoods: Composite and plastic UL94V-0; brass or steel with zinc plate and chromate seal. Aluminum; aluminum with electroless nickel plate. For aluminum hoods, zinc content is 1% maximum. Die cast zinc.

Non-magnetic versions are available, contact Technical Sales.

MECHANICAL CHARACTERISTICS:

Signal Contacts, Crimp Removable: Size 20 contacts, male – 0.040 inch [1.02mm] mating diameter; Female rugged open entry or PosiBand closed entry contact design, see page 69 for details.

Contact Retention In Insulator: Signal: 9 lbs. [40N]. Power, shielded and high voltage: 22 lbs. [98N]

Crimp Contact Terminations: Closed barrel crimp, wire sizes 18 AWG [1.0mm²] through 30 AWG [0.05 mm²]

Power Contacts, Removable, Crimp or Solder Termination: Size 8 contacts, male – 0.142 inch [3.61mm] mating diameter. Terminations for 6, 8, 10, 12, and 16 AWG. Female contact features Large Surface Area (L.S.A.) closed entry contact design utilizing BeCu mechanical retention member. Closed crimp barrel.

Shielded Contacts, Removable: See table of cable sizes for contact termination dimensions, page 78.

High Voltage Contacts: Straight and right angle (90°) terminations – 0.041 inch [1.04mm] min. hole diameter.

Shells: Male shells may be dimpled for EMI/ESD ground paths.

Polarization: Trapezoidally shaped shells and polarized jackscrews.

Locking Systems: Jackscrews and vibration locking systems.

Mechanical Operations: 500 operations for open entry contact, 1000 operations for PosiBand closed entry contact with 0.000050 [1.27µ] gold plating. Per IEC 60512-5.

ELECTRICAL CHARACTERISTICS:

SIZE 20 CONTACTS

Contact Current Rating: 7.5 amperes nominal.
Initial Contact Resistance: 0.008 ohms maximum.
Proof Voltage: 1000 V r.m.s.

SIZE 8 CONTACTS

POWER CONTACTS

For electrical characteristics, see page 4.

SHIELDED CONTACTS

For electrical characteristics, see page 69.

HIGH VOLTAGE CONTACTS

For electrical characteristics, see page 69.

CONNECTOR

Insulation Resistance: 5 G ohms.
Clearance and Creepage Distance: 0.039 [1.0mm] minimum.
Working Voltage: 300 V r.m.s.

CLIMATIC CHARACTERISTICS:

Temperature Range: -55°C to +125°C.
Damp Heat, Steady State: 10 days.

THERMOCOUPLE CONTACTS:

Size 20 crimp contacts are available. See page 74 for details.

PCB mount contacts are available in CBD/CBM series, see page 4 for details.



**CBC11W1M10Z00
WITH MS4012D CONTACT**

**CBC11W1S100T20
WITH FC4008D CONTACT**



***1 CONTACT VARIANTS**

FACE VIEW OF MALE OR REAR VIEW OF FEMALE

NOTES:

*1 Additional contact variants may be tooled at customer request.

*2 13W6 and 27W2 variant currently available in female only. Contact Technical Sales for availability of male connector.

Note: Connectors can be kitted with all applicable removable contacts, contact Technical Sales for connector part number.

— SHELL SIZE 1 —

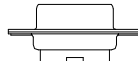
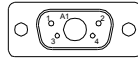

5W1

— SHELL SIZE 2 —

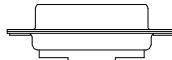
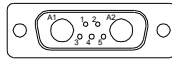

7W2

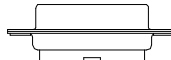
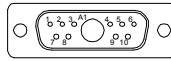

11W1

— SHELL SIZE 3 —

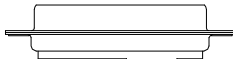
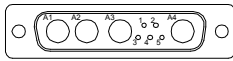

9W4

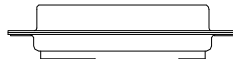
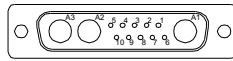

13W3

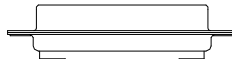
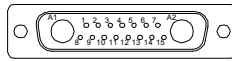

17W2

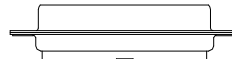
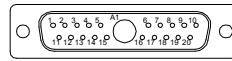

21W1

— SHELL SIZE 4 —

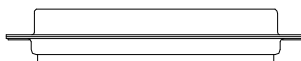
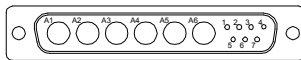

*2 13W6

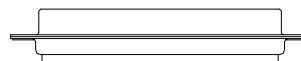

21WA4

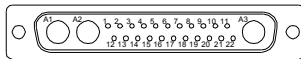

25W3

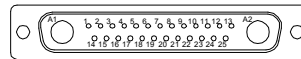

*2 27W2

— SHELL SIZE 5 —

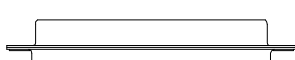
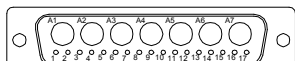

24W7

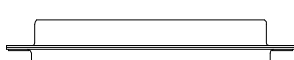
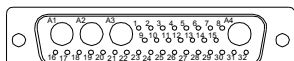

36W4

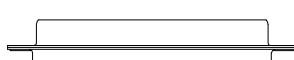
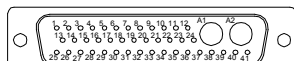

43W2

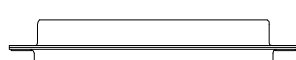
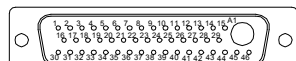

47W1

— SHELL SIZE 6 —

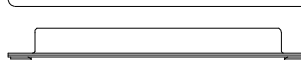
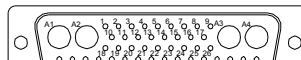

46W4



Positronic
connectpositronic.com

PROFESSIONAL, INDUSTRIAL AND MILITARY QUALITY
THREE PERFORMANCE LEVELS FOR BEST COST/PERFORMANCE RATIO
STANDARD DENSITY CRIMP REMOVABLE CONTACTS

Combo-D
D-Sub

STANDARD SHELL ASSEMBLY



CBC7W2S00000

CBC17W2M00000

TYPICAL CONNECTOR TOP VIEW

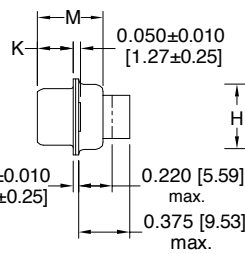
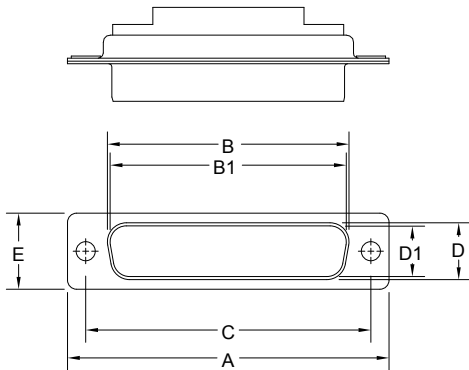

RECOMMENDED MATING DIMENSIONS

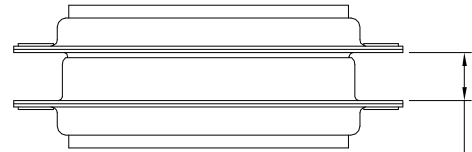

Shell Sizes 1 & 2 =
0.265±0.015 [6.73±0.38]
Shell Sizes 3, 4, 5 & 6 =
0.256±0.015 [6.50±0.38]

CBC SERIES

OPTIONAL SHELL ASSEMBLY (0, 02)

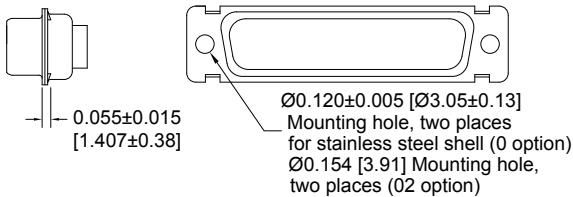

OPTIONAL SHELL ASSEMBLY WITH UNIVERSAL FLOAT MOUNTS (F)

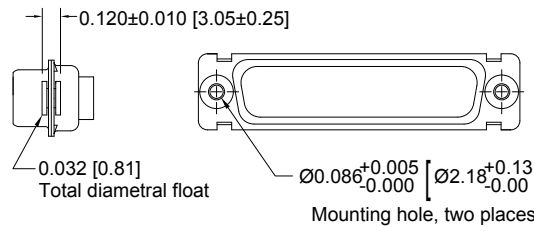

SHELL SIZES	A ±0.015 [0.38]	B ±0.005 [0.13]	B1 ±0.005 [0.13]	C ±0.005 [0.13]	D ±0.005 [0.13]	D1 ±0.005 [0.13]	E ±0.015 [0.38]	G ±0.010 [0.25]	H ±0.010 [0.25]	K ±0.005 [0.13]	M ±0.010 [0.25]
SHELL SIZE 1 MALE	1.213 [30.81]		0.666 [16.92]	0.984 [24.99]		0.329 [8.36]	0.494 [12.55]	0.759 [19.28]	0.422 [10.72]	0.233 [5.92]	0.422 [10.72]
SHELL SIZE 1 FEMALE	1.213 [30.81]	0.643 [16.33]		0.984 [24.99]	0.311 [7.90]		0.494 [12.55]	0.759 [19.28]	0.422 [10.72]	0.243 [6.17]	0.429 [10.90]
SHELL SIZE 2 MALE	1.541 [39.14]		0.994 [25.25]	1.312 [33.32]		0.329 [8.36]	0.494 [12.55]	1.083 [27.51]	0.422 [10.72]	0.233 [5.92]	0.422 [10.72]
SHELL SIZE 2 FEMALE	1.541 [39.14]	0.971 [24.66]		1.312 [33.32]	0.311 [7.90]		0.494 [12.55]	1.083 [27.51]	0.422 [10.72]	0.243 [6.17]	0.429 [10.90]
SHELL SIZE 3 MALE	2.088 [53.04]		1.534 [38.96]	1.852 [47.04]		0.329 [8.36]	0.494 [12.55]	1.625 [41.28]	0.422 [10.72]	0.230 [5.84]	0.426 [10.82]
SHELL SIZE 3 FEMALE	2.088 [53.04]	1.511 [38.38]		1.852 [47.04]	0.311 [7.90]		0.494 [12.55]	1.625 [41.28]	0.422 [10.72]	0.243 [6.17]	0.429 [10.90]
SHELL SIZE 4 MALE	2.729 [69.32]		2.182 [55.42]	2.500 [63.50]		0.329 [8.36]	0.494 [12.55]	2.272 [57.71]	0.422 [10.72]	0.230 [5.84]	0.426 [10.82]
SHELL SIZE 4 FEMALE	2.729 [69.32]	2.159 [54.84]		2.500 [63.50]	0.311 [7.90]		0.494 [12.55]	2.272 [57.71]	0.422 [10.72]	0.243 [6.17]	0.429 [10.90]
SHELL SIZE 5 MALE	2.635 [66.93]		2.079 [52.81]	2.406 [61.11]		0.441 [11.20]	0.605 [15.37]	2.178 [55.32]	0.534 [13.56]	0.230 [5.84]	0.426 [10.82]
SHELL SIZE 5 FEMALE	2.635 [66.93]	2.064 [52.43]		2.406 [61.11]	0.423 [10.74]		0.605 [15.37]	2.178 [55.32]	0.534 [13.56]	0.243 [6.17]	0.429 [10.90]
SHELL SIZE 6 MALE	2.729 [69.32]		2.212 [56.18]	2.500 [63.50]		0.503 [12.78]	0.668 [16.97]	2.302 [58.47]	0.596 [15.14]	0.230 [5.84]	0.426 [10.82]
SHELL SIZE 6 FEMALE	2.729 [69.32]	2.189 [55.60]		2.500 [63.50]	0.485 [12.32]		0.668 [16.97]	2.302 [58.47]	0.596 [15.14]	0.243 [6.17]	0.429 [10.90]



ORDERING INFORMATION - CODE NUMBERING SYSTEM

Specify Complete Connector By Selecting An Option From Step 1 Through 8

STEP	1	2	3	4	5	6	7	8	9	10
EXAMPLE	CBC	7W2	M	1	0	Z	0	0	/AA	-14
STEP 1 - BASIC SERIES CBC Series										*2 STEP 10 - SPECIAL OPTIONS FOR SPECIAL OPTIONS, SEE SPECIAL OPTIONS APPENDIX ON PAGE 81.
STEP 2 - CONNECTOR VARIANTS Shell Size 1 5W1 Shell Size 2 7W2, 11W1 Shell Size 3 9W4, 13W3, 17W2, 21W1 Shell Size 4 *113W6, 21WA4, 25W3, *127W2 Shell Size 5 24W7, 36W4, 43W2, 47W1 Shell Size 6 46W4										STEP 9 - ENVIRONMENTAL COMPLIANCE OPTIONS /AA - RoHS Compliant NOTE: If compliance to environmental legislation is not required, this step will not be used. Example: CBC7W2M10Z00
STEP 3 - CONNECTOR GENDER M - Male S - Female - Industrial or Military Level PosiBand Closed Entry Signal Contacts Professional Level female open entry contacts are available and can be ordered separately, see page 73.										STEP 8 - SHELL OPTIONS 0 - Zinc Plated, with Chromate Seal. *S - Stainless Steel, passivated. X - Tin Plated. Z - Tin Plated and Dimpled (male connectors only)
STEP 4 - CONTACT TERMINATION TYPE 0 - Connector ordered without contacts. Order signal, power, shielded, high voltage, air and thermocouple contacts separately. See pages 68-80 for contact part numbers. 1 - Signal contacts, 20 AWG-24 AWG [0.5mm ² -0.25mm ²]. 11 - Signal contacts, 20 AWG-24 AWG [0.5mm ² -0.25mm ²] with MC/FC 4012D Power Contact. 12 - Signal contacts, 20 AWG-24 AWG [0.5mm ² -0.25mm ²] with MC/FC 4016D power contact. 13 - Signal contacts, 20 AWG-24 AWG [0.5mm ² -0.25mm ²] with MCC/FCC 4101D shielded contacts. 14 - Signal contacts, 20 AWG-24 AWG [0.5mm ² -0.25mm ²] with MCC/FCC 4102D shielded contacts.										*2 STEP 7 - LOCKING AND POLARIZING SYSTEMS 0 - None. V3 - Lock Tab, connector front panel mounted. V5 - Lock Tab, connector rear panel mounted. VL - Lock Lever, used with Hoods only. T - Fixed Female Jackscrews. T2 - Fixed Female Jackscrews. T6 - Fixed Male and Female Polarized Jackscrews. E - Rotating Male Jackscrews. E2 - Rotating Male Screw Locks. E3 - Rotating Male with Internal Hex for 3/32 Hex Drives E6 - Rotating Male and Female Polarized Jackscrews.
*2 STEP 5 - MOUNTING STYLE 0 - Mounting Hole, 0.120 [3.05] Ø 02 - Mounting Hole, 0.154 [3.91] Ø F - Float Mounts, Universal S2 - Swaged Spacer, 4-40 Threads, 0.125 [3.18] Length S5 - Swaged Locknut, 4-40 Threads										*2 STEP 6 - HOODS 0 - None H - Hood, Top Opening, Metal, shell sizes 2 through 5 AN - Lightweight Aluminum Hood, nickel finish. AC - Lightweight Aluminum Hood, no finish. *G - Hood, EMI/RFI, Die Cast Zinc, shell sizes 1 through 6 Z - Hood, Top or Side Opening, robust extended height, plastic and composite, with rotating jackscrews, shell sizes 1 through 5
NOTES *1 Connector variant 13W6 and 27W2 are currently available in female only, contact Technical Sales for availability of male connector. *2 For additional information on accessories listed in steps 5, 6, 7 and 10, see Accessory Catalog. *3 When using G hood with CBC variants, use the extended height hood. See Accessories Catalog for extended G hood options. *4 For stainless steel dimpled male versions, contact Technical Sales.										NOTE: If you would like a 2D drawing or 3D model, once you've made your connector selection, please visit www.connectpositronic.com . If you can't find your specific part number on our web site, contact Technical Sales to have one created.

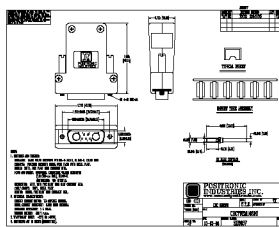

2D Drawing



3D Model

For crimping information and crimp tools, see Application Tools section, page 82.



Positronic
connectpositronic.com

PROFESSIONAL, INDUSTRIAL AND MILITARY QUALITY
THREE PERFORMANCE LEVELS FOR BEST COST/PERFORMANCE RATIO
HIGH DENSITY PCB MOUNT

Combo-D
D-Sub

Size 22 Fixed Signal and Thermocouple Contacts

Size 16 Fixed Power Contacts

Size 8 Removable Power, Shielded, Air and High Voltage Contacts

UL and CSA Recognition, for status contact Technical Sales



Positronic's Combo-D connectors are a popular choice for a wide variety of applications. Many options make the Combo-D a versatile connector choice.

CBDD high density series connectors are quality connectors recommended for use in sheltered, non-corrosive indoor and outdoor environments having normal ventilation, but without temperature or humidity controls.

CBDD series connectors offer mixed contact combinations of power, signal, and thermocouple contacts within the same connector body.

CBDD series connectors utilize precision machined contacts offering high reliability. Connector variants are available with straight and right angle (90°) printed board mount terminations, including compliant press-fit. For cable connectors see CBCD section, page 39.

Female power contacts feature the Large Surface Area (L.S.A.)

closed entry contact design, which provides maximum mating surfaces between male and female contacts and reduced contact resistance during operation.

Fixed signal contacts are available with open entry female contacts, professional level or PosiBand closed entry female contacts, industrial level. Military contact plating is optional.

A wide assortment of printed board mounting hardware, cable support hoods, and locking systems is available from stock.

A blind mating system is available for applications requiring connector coupling in recessed areas or mobile power coupling systems.

Straight and right angle PCB mount thermocouple contacts are available, please contact Technical Sales for details.

CBDD series connectors utilize precision machined contacts and meet applicable performance and dimensional requirements of IEC 60807-7, MIL-DTL-24308 and AS39029.

TECHNICAL CHARACTERISTICS

MATERIALS AND FINISHES:

Insulator:	Glass filled polyester per ASTM D 5927 UL 94V-0, blue color.
Contacts:	Precision machined copper alloy.
Contact Plating:	
SIGNAL:	Gold flash over nickel plate. Other finishes available upon request, see page 81.
POWER:	Gold flash over nickel. Other finishes available upon request, see page 81.
SHIELDED:	For contact platings, see page 68.
HIGH VOLTAGE:	For contact platings, see page 68.
Shells:	Steel with tin plate; zinc plate with chromate seal; stainless steel passivated. Other materials and finishes available upon request.
Mounting Spacers and Brackets:	Nylon; polyester; copper alloy or steel with zinc plate and chromate seal or tin plate; phosphor bronze with tin plate; stainless steel, passivated.
Push-On Fasteners:	Phosphor bronze and beryllium copper with tin plate.
Jackscrew Systems:	Brass or steel with zinc plate and chromate seal or clear zinc plate or tin plate; stainless steel, passivated.
Hoods:	Composite and plastic, UL 94V-0; brass or steel with zinc plate and chromate seal Aluminum; aluminum with electroless nickel plate. For aluminum hoods, zinc content is 1% maximum. Die cast zinc.

Non-magnetic versions are available, contact Technical Sales.

MECHANICAL CHARACTERISTICS:

Signal Contacts, Fixed:	Size 22 contacts, male – 0.030 inch [0.76mm] mating diameter. Female – open entry or PosiBand closed entry design, see page 69 for details.
Power Contacts, Fixed:	Size 16 contacts, male – 0.0625 inch [1.588mm] mating diameter. Female contacts - closed entry design. Size 8 contacts, male - 0.142 inch [3.61mm] mating diameter. Female contact features Large Surface Area (L.S.A.) closed entry contact design utilizing BeCu mechanical retention member. Closed crimp barrel.
Contact Retention in Insulator:	
SIGNAL SIZE 22	5 lbs. [21N] minimum
POWER SIZE 16	6 lbs [26N] minimum
SIZE 8	22 lbs [98N] for power, shielded and high voltage.
Resistance to Solder Iron Heat:	500°F [260°C] for 10 seconds duration per IEC 60512-6.
Signal Contact Terminations:	Solder contacts - 0.035 inch [0.89mm] minimum hole diameter for 22 AWG [0.3 mm ²] wire maximum.



TECHNICAL CHARACTERISTICS, continued

continued from previous page. . . .

Power Contacts, Terminations:	<p>Straight Printed Board Mount – 0.020 inch [0.51mm] diameter.</p> <p>Right Angle (90°) Printed Board Mount – 0.030 inch [0.76 mm] diameter.</p> <p>Size 16 contacts- printed board terminations with 0.063 inch [1.60mm] diameters.</p> <p>Size 8 contacts - printed board terminations with 0.078 inch [1.98mm], 0.094 inch [2.39mm] and 0.125 inch [3.18mm] termination diameters.</p>
Shielded Contacts, Removable:	See table of cable sizes for contact termination dimensions, page 78.
High Voltage Contacts:	Straight and right angle (90°) terminations – 0.041 inch [1.04mm] minimum hole diameter.
Shells:	Male shells may be dimpled for EMI/ESD ground paths.
Polarization:	Trapezoidally shaped shells and polarized jackscrews.
Mounting to Angle Brackets:	Jackscrews and riveted fasteners with 0.120 inch [3.05mm] diameter hole, and threaded riveted fasteners with 4-40 threads and nylon inserts.
Mounting to Printed Board:	Rapid installation push-on fasteners and threaded posts.
Locking Systems:	Jackscrews and vibration locking systems.
Mechanical Operations:	Open entry, 500 operations. PosiBand closed entry, 1000 operations minimum. Per IEC 60512-5.

SIZE 16 CONTACTS

POWER CONTACTS

Contact Current Rating - Tested per UL 1977:

Standard Contact Material: 28 amperes.
High Conductivity Contact Material: 40 amperes.

See Temperature Rise Curves on page 2 for details.

Initial Contact Resistance:

Standard Contact Material: 0.0016 ohms max. Per IEC 60512-2, Test 2b.

High Conductivity Contact Material:

0.001 ohms max. Per IEC 60512-2, Test 2b.
1000 V r.m.s.

Proof Voltage:

SIZE 8 CONTACTS

POWER CONTACTS

For electrical characteristics, see page 4.

SHIELDED CONTACTS

For electrical characteristics, see page 69.

HIGH VOLTAGE CONTACTS

For electrical characteristics, see page 69.

CONNECTOR

Insulation Resistance:

5 G ohms.

Clearance and Creepage Distance:

0.042 inch [1.06mm] minimum.

Working Voltage:

300 V r.m.s.

CLIMATIC CHARACTERISTICS:

Temperature Range:

-55°C to +125°C.

Damp Heat, Steady State:

10 days.

THERMOCOUPLE CONTACTS:

Straight and right angle PCB mount contacts are available, please contact Technical Sales for details.

Size 22 crimp contacts are available in CBCD series, see page 71 for details.

ELECTRICAL CHARACTERISTICS:

SIZE 22 CONTACT

Contact Current Rating:	5 amperes nominal.
Initial Contact Resistance:	0.010 ohms maximum for open entry 0.005 ohms maximum for closed entry
Proof Voltage:	1000 V r.m.s.

*1 CONTACT VARIANT

FACE VIEW OF MALE OR REAR VIEW OF FEMALE

— SHELL SIZE 1 —

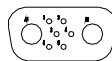

8W2

Six Size 22 Signal Contacts and
Two Size 16 Power Contacts

— SHELL SIZE 2 —

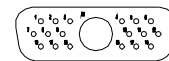

19W1

Eighteen Size 22 Signal Contacts
and One Size 8 Power Contact

Note: Connectors can be kitted with all applicable removable contacts, contact Technical Sales for connector part number.

— SHELL SIZE 3 —



***2 15W4**

Eleven Size 22 Signal Contacts
and Four Size 8 Power Contacts

— SHELL SIZE 4 —

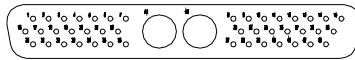

***3 45W2**

Forty-three Size 22 Signal Contacts
and Two Size 8 Power Contacts

NOTES:

- *1 Additional contact variants may be tooled at customer request.
- *2 For technical, dimensional and PCB layout information on 15W4 variants, contact Technical Sales.
- *3 45W2 variant currently available in male only. Contact Technical Sales for availability of female connector.



Positronic
connectpositronic.com

PROFESSIONAL, INDUSTRIAL AND MILITARY QUALITY
THREE PERFORMANCE LEVELS FOR BEST COST/PERFORMANCE RATIO
HIGH DENSITY PCB MOUNT

Combo-D
D-Sub

STANDARD SHELL ASSEMBLY

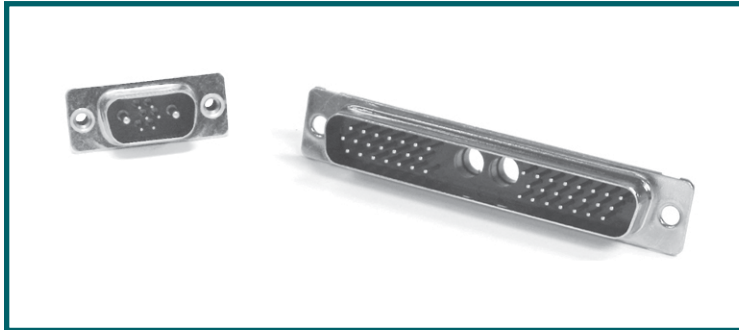

CBDD8W2M3S000

CBDD45W2M30000

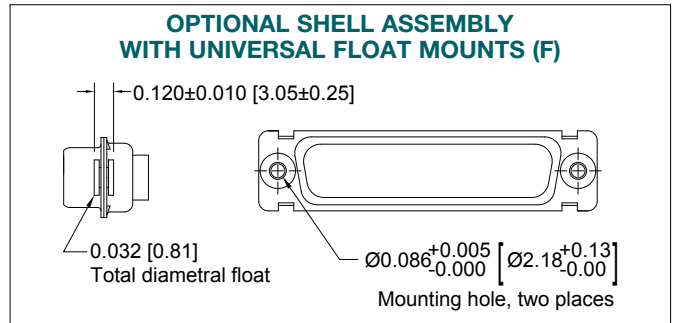
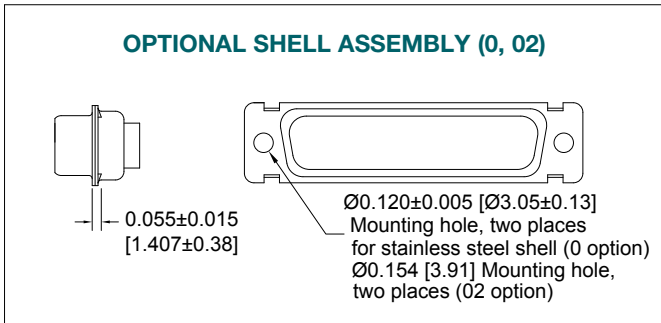
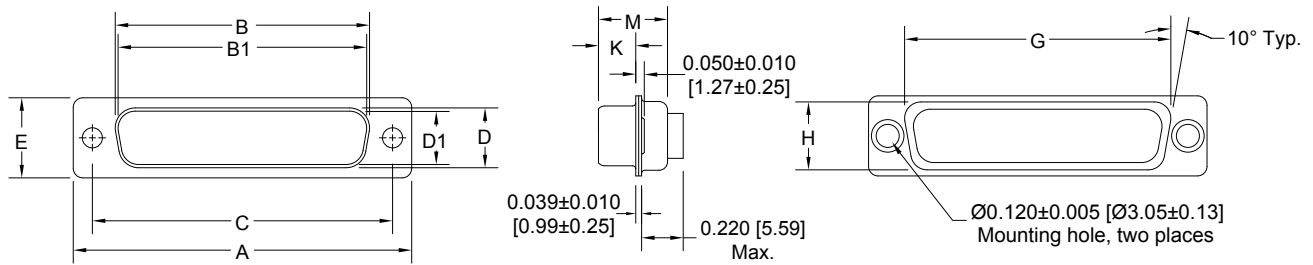
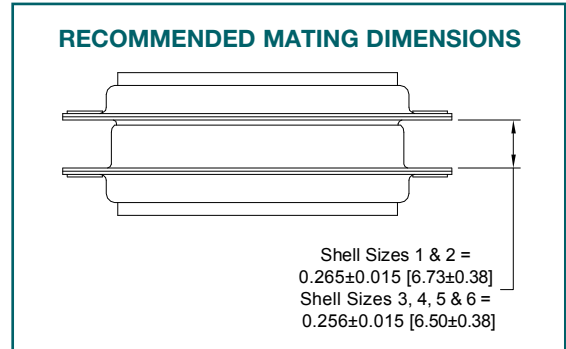

SHELL SIZES	VARIANT	A ±0.015 [0.38]	B ±0.005 [0.13]	B1 ±0.005 [0.13]	C ±0.005 [0.13]	D ±0.005 [0.13]	D1 ±0.005 [0.13]	E ±0.015 [0.38]	G ±0.010 [0.25]	H ±0.010 [0.25]	K ±0.005 [0.13]	M ±0.010 [0.25]
1	8W2M	1.213 [30.81]		0.666 [16.92]	0.984 [24.99]		0.329 [8.36]	0.494 [12.55]	0.759 [19.28]	0.422 [10.72]	0.233 [5.92]	0.422 [10.72]
	8W2F	1.213 [30.81]	0.643 [16.33]		0.984 [24.99]	0.311 [7.90]		0.494 [12.55]	0.759 [19.28]	0.422 [10.72]	0.243 [6.17]	0.429 [10.90]
	8W2S	1.213 [30.81]			0.984 [24.99]			0.494 [12.55]	0.759 [19.28]	0.422 [10.72]	0.243 [6.17]	0.429 [10.90]
2	19W1M	1.541 [39.14]		0.994 [25.25]	1.312 [33.32]		0.329 [8.36]	0.494 [12.55]	1.083 [27.51]	0.422 [10.72]	0.233 [5.92]	0.422 [10.72]
	19W1F	1.541 [39.14]	0.971 [24.66]		1.312 [33.32]	0.311 [7.90]		0.494 [12.55]	1.083 [27.51]	0.422 [10.72]	0.243 [6.17]	0.429 [10.90]
	19W1S	1.541 [39.14]			1.312 [33.32]			0.494 [12.55]	1.083 [27.51]	0.422 [10.72]	0.243 [6.17]	0.429 [10.90]
4	45W2M	2.729 [69.32]		2.182 [55.42]	2.500 [63.50]		0.329 [8.36]	0.494 [12.55]	2.272 [57.71]	0.422 [10.72]	0.230 [5.84]	0.426 [10.82]

SOLDER CUP CONNECTOR CODE 21

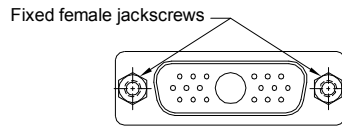
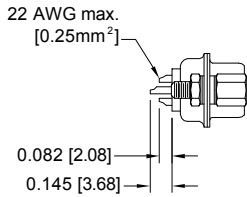

For solder cup contacts, specify code 21 in step 4 of ordering information.

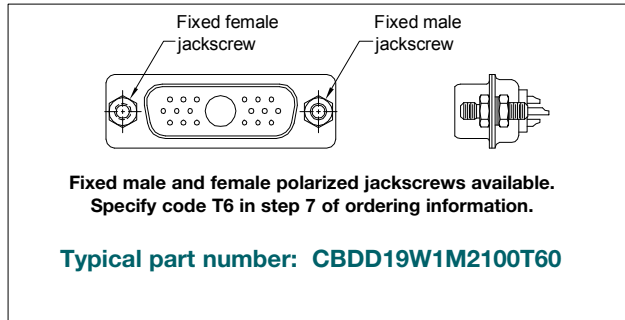

Typical part number: **CBDD19W1M2100T0**

STRAIGHT PRINTED BOARD MOUNT CONNECTOR CODE 3, 35, 36, AND 37

CONTACT CODE	D Ø
3	-----

For straight printed board mount contacts, specify code 3 in step 4 of ordering information.

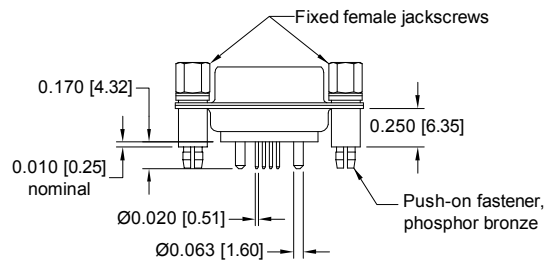

Typical part number: **CBDD8W2F3S60T2X**

CONTACT CODE	D Ø
3	-----
35	0.078 [1.98]
36	0.094 [2.39]
37	0.125 [3.18]

For straight printed board mount contacts, specify code no. in step 4 of ordering information.

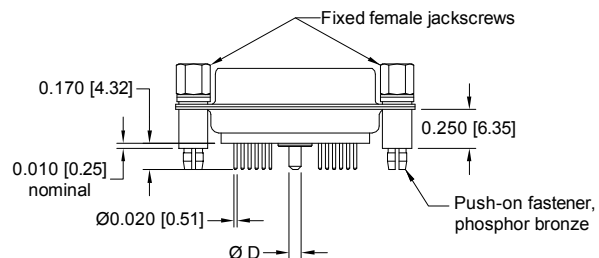

Typical part number: **CBDD19W1F35S60T2X**



Positronic
connectpositronic.com

PROFESSIONAL, INDUSTRIAL AND MILITARY QUALITY
THREE PERFORMANCE LEVELS FOR BEST COST/PERFORMANCE RATIO
HIGH DENSITY PCB MOUNT

Combo-D
D-Sub

RIGHT ANGLE (90°) PRINTED BOARD MOUNT CONNECTOR
SIZE 16 POWER CONTACTS WITH 0.063 [1.60] Ø TERMINATIONS
CODE 4, 0.314 [7.98] CONTACT EXTENSION

See temperature rise curves on pages 1 and 2

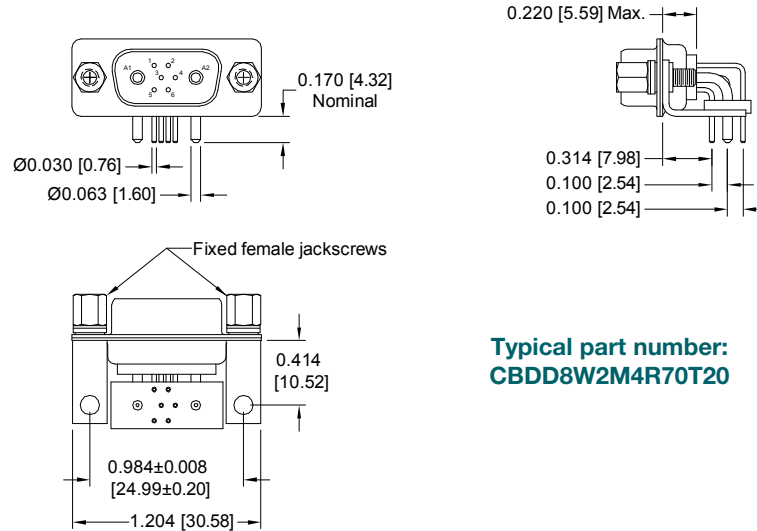

Typical part number:
CBDD8W2M4R70T20

RIGHT ANGLE (90°) PRINTED BOARD MOUNT CONNECTOR
SIZE 8 POWER CONTACTS WITH 0.078 [1.98] Ø TERMINATIONS
CODE 4 AND 45, 0.314 [7.98] CONTACT EXTENSION

See temperature rise curves on pages 1 and 2

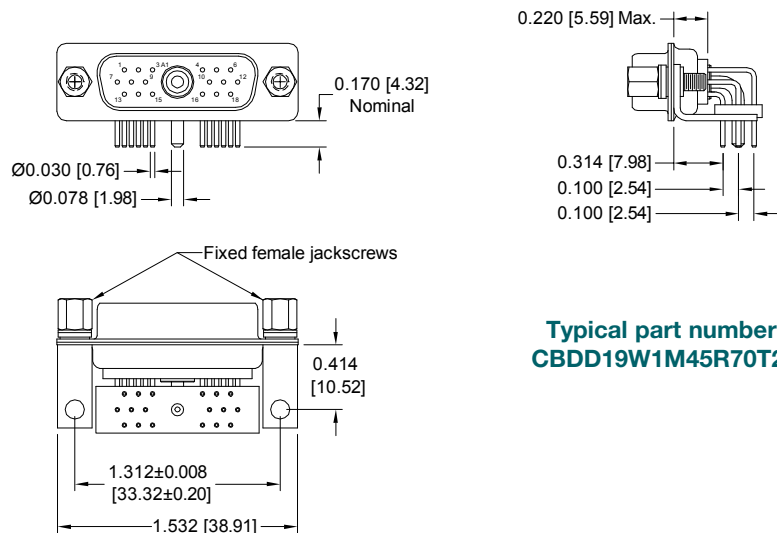

Typical part number:
CBDD19W1M45R70T20

CBDD/CBHD SERIES



RIGHT ANGLE (90°) PRINTED BOARD MOUNT CONNECTOR
SIZE 8 POWER CONTACTS WITH 0.078 [1.98] Ø TERMINATIONS
CODE 4 AND 45, 0.314 [7.98] CONTACT EXTENSION

See temperature rise curves on pages 1 and 2

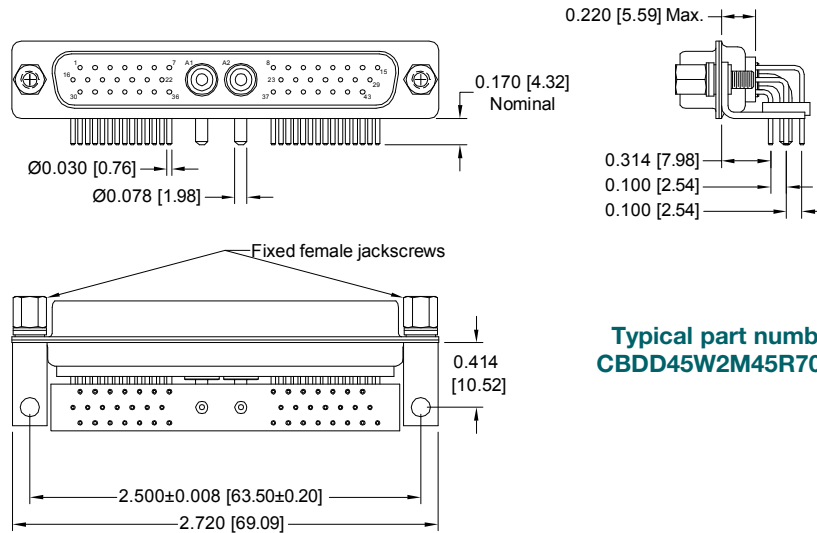

Typical part number:
CBDD45W2M45R70T20

RIGHT ANGLE (90°) PRINTED BOARD MOUNT CONNECTOR
SIZE 8 POWER CONTACTS WITH 0.125 [3.18] Ø TERMINATIONS
CODE 4 AND 47, 0.314 [7.98] CONTACT EXTENSION

See temperature rise curves on pages 1 and 2

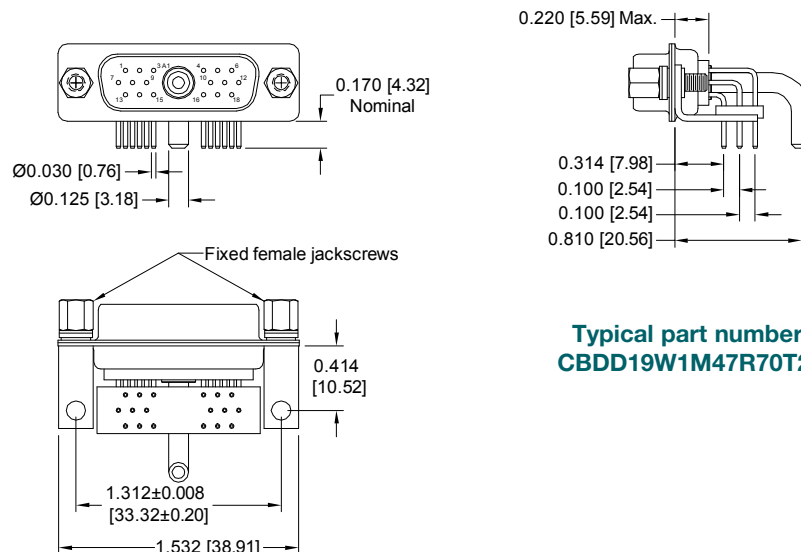

Typical part number:
CBDD19W1M47R70T20



Positronic
connectpositronic.com

PROFESSIONAL, INDUSTRIAL AND MILITARY QUALITY
THREE PERFORMANCE LEVELS FOR BEST COST/PERFORMANCE RATIO
HIGH DENSITY PCB MOUNT

Combo-D
D-Sub

RIGHT ANGLE (90°) PRINTED BOARD MOUNT CONNECTOR
SIZE 8 POWER CONTACTS WITH 0.125 [3.18] Ø TERMINATIONS
CODE 4 AND 47, 0.314 [7.98] CONTACT EXTENSION

See temperature rise curves on pages 1 and 2

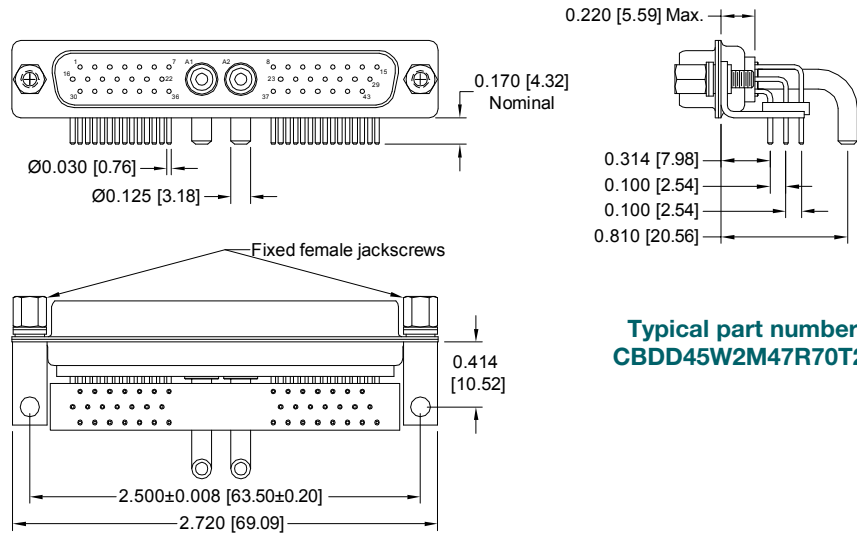

Typical part number:
CBDD45W2M47R70T20

Connectors Designed To Customer Specifications

Positronic Combo-D connectors can be modified to customers specifications.

Examples: select loading of contacts for cost savings or to gain creepage and clearance distances; longer PCB terminations; customer specified hardware; sealing for water resistance.

Contact Technical Sales with your particular requirements.



**STRAIGHT PRINTED BOARD MOUNT CONNECTOR
WITH FDS4201D OR MDS4201D SHIELDED CONTACTS
CODE 65**

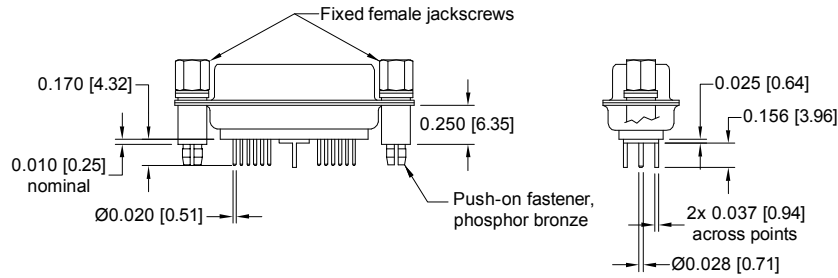

Typical part number:
CBDD19W1M65S60T20

Shielded contacts only
visible this view for clarity

**RIGHT ANGLE (90°) PRINTED BOARD MOUNT CONNECTOR
WITH FRT4201D OR MRT4201D SHIELDED CONTACTS
CODE 84**

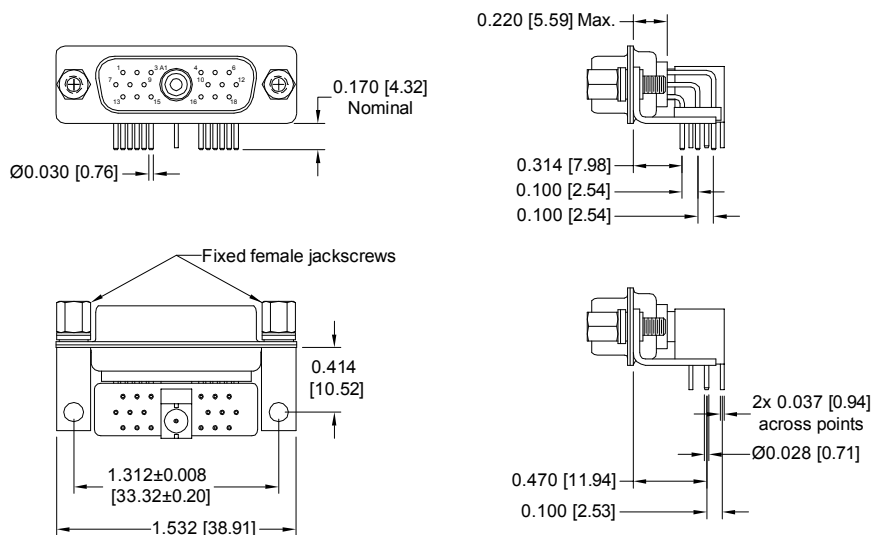

Typical part number:
CBDD19W1M84R70T20

Shielded contacts only
visible this view for clarity



Positronic
connectpositronic.com

PROFESSIONAL, INDUSTRIAL AND MILITARY QUALITY
THREE PERFORMANCE LEVELS FOR BEST COST/PERFORMANCE RATIO
HIGH DENSITY PCB MOUNT

Combo-D
D-Sub

RIGHT ANGLE (90°) PRINTED BOARD MOUNT CONNECTOR WITH FRT4201D OR MRT4201D SHIELDED CONTACTS

CODE 84

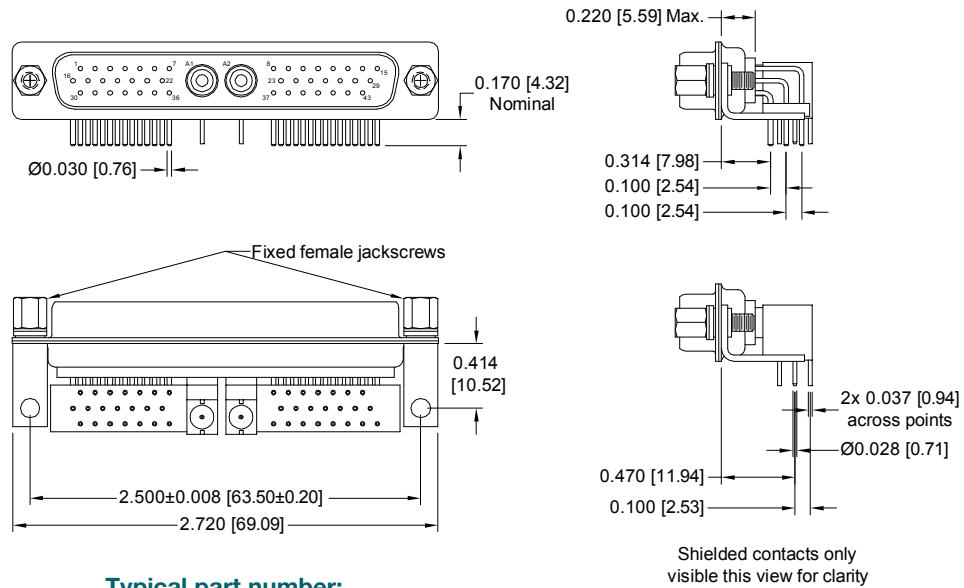

Typical part number:
CBDD45W2M84R70T20

COMPLIANT PRESS-FIT CONNECTOR CODE 93

Positronic recommends the practice of using mounting hardware to secure connector to printed circuit board.

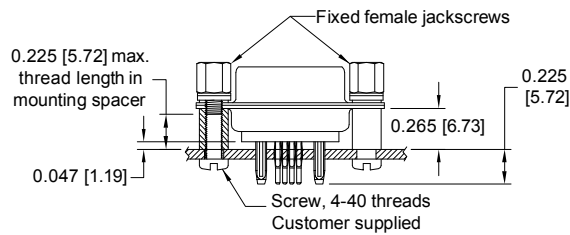

TYPICAL PART NUMBER: CBDD8W2M93S0T20

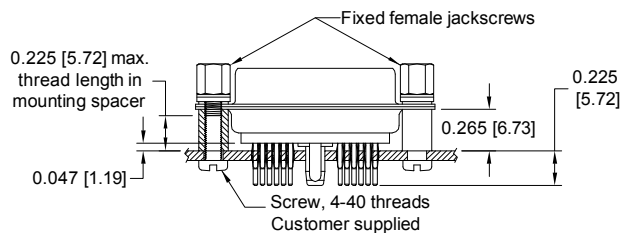

TYPICAL PART NUMBER: CBDD19W1M93S0T20



PRINTED BOARD MOUNT CONTACT HOLE PATTERN

HOLE IDENTIFICATION SHOWN FOR MALE CONNECTOR; USE MIRROR IMAGE FOR FEMALE CONNECTOR.
MOUNT RIGHT ANGLE (90°) CONNECTOR WITH MATING FACE POSITIONED TO FOLLOW DIRECTION OF ARROWS.

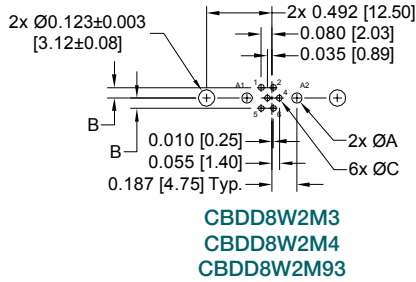

SUGGESTED BOARD HOLE SIZES	VARIANT	CODE	ØA	B	ØC
	8W2	3		0.080 [2.03]	0.078 [1.98]
4			0.080 [2.03]	0.100 [2.54]	0.045 [1.14]
93		See chart for size 16 contact on page 85.		0.078 [1.98]	See chart for size 22 contact on page 85.
19W1 AND 45W2	3, 35		0.098 [2.49]	0.078 [1.98]	0.035 [0.89]
	36		0.114 [2.90]		
	37		0.145 [3.68]		
	4, 45		0.098 [2.49]	0.100 [2.54]	0.045 [1.14]
	47		N/A	N/A	N/A
	65		N/A	N/A	N/A
84		N/A	N/A	N/A	
93	See chart for size 8 contact on page 85.			0.078 [1.98]	See chart for size 22 contact on page 85.

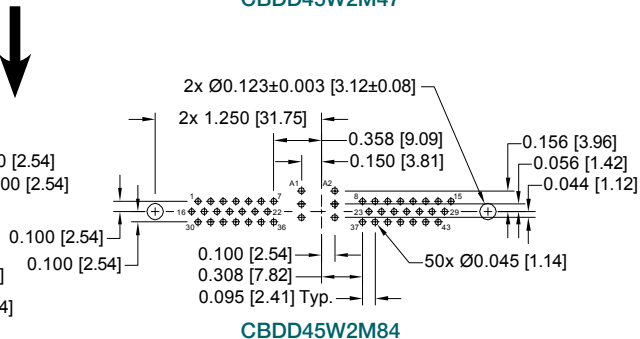
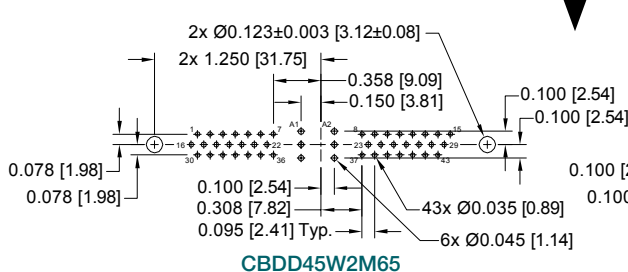
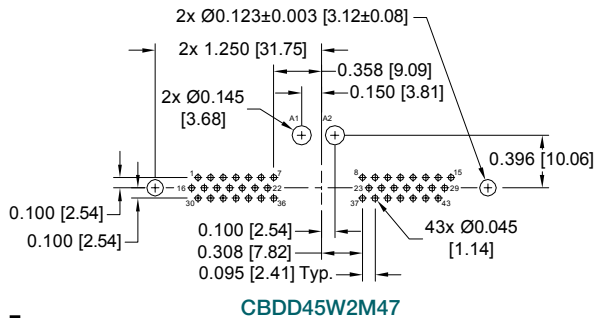
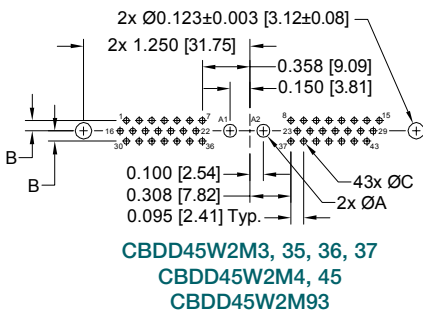
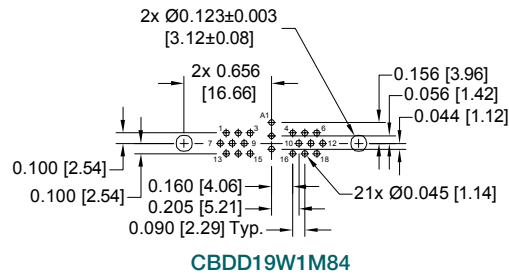
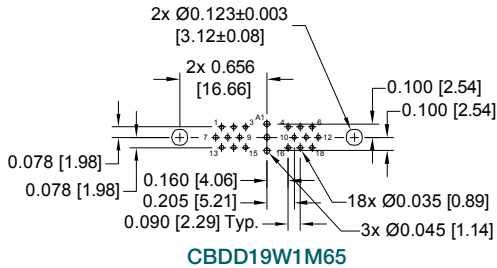
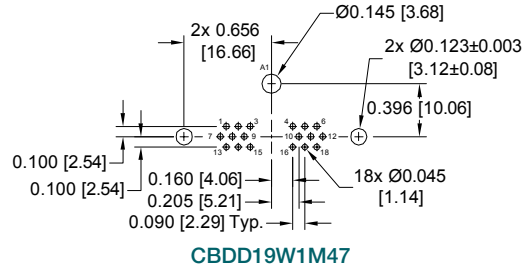
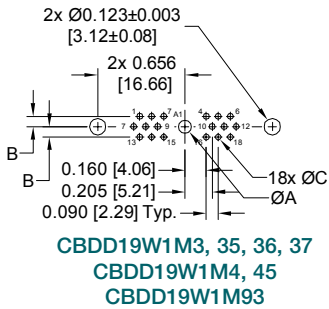



Positronic
connectpositronic.com

PROFESSIONAL, INDUSTRIAL AND MILITARY QUALITY
THREE PERFORMANCE LEVELS FOR BEST COST/PERFORMANCE RATIO
HIGH DENSITY PCB MOUNT

Combo-D
D-Sub



ORDERING INFORMATION - CODE NUMBERING SYSTEM

Specify Complete Connector By Selecting An Option From Step 1 Through 8

FOR CONNECTORS NOT INCLUDING SIZE 8 CONTACTS

STEP	1	2	3	4	5	6	7	8	9	10
EXAMPLE	CBDD	8W2	M	93	S	0	0	0	/AA	-14

STEP 1 - BASIC SERIES

CBDD Series -
CBHD Series - High Conductivity
Power Contacts

STEP 2 - CONNECTOR VARIANTS

Shell Size 1 - 8W2

See next page for ordering information
for other shell size options.

STEP 3 - CONNECTOR GENDER

*1 F - Female - Professional Level -
Open Entry Signal Contacts

M - Male

*1 S - Female - Industrial / Military Level -
PosiBand Closed Entry Signal Contacts

STEP 4 - CONTACT TERMINATION TYPE

*5 21 - Fixed Solder Cup, 22 AWG-30 AWG [0.3mm²-0.05mm²].

*5 3 - Solder, Straight Printed Board Mount, 0.170 [4.32] Tail
length.

*5 4 - Solder, Right Angle (90°) Printed Board Mount, 0.314
[7.98] Signal Contact Extension.

93 - Signal Omega type compliant and Power Bi-Spring type
compliant, termination length 0.225 [5.72].

*2 STEP 5 - MOUNTING STYLE

0 - Mounting Hole, 0.120 [3.05] Ø

02 - Mounting Hole, 0.154 [3.91] Ø

B3 - Bracket, Mounting, Right Angle (90°) Metal with Cross Bar

B8 - Bracket, Mounting, Right Angle (90°) Plastic with Cross Bar

F - Float Mounts, Universal

P - Threaded Post, Brass, 0.250 [6.35] Length

P2 - Threaded Post, Nylon, 0.250 [6.35] Length

R2 - Bracket, Mounting, Right Angle (90°) Metal, Swaged to Connector
with 4-40 Thread Fixed Female Jackscrews with Cross Bar

R6 - Bracket, Mounting, Right Angle (90°) Metal, Swaged to Connector
with 0.120 [3.05] Ø Mounting Hole with Cross Bar

R7 - Bracket, Mounting, Right Angle (90°) Metal, Swaged to Connector
with 4-40 Threads with Cross Bar

R8 - Bracket, Mounting, Right Angle (90°) Metal, Swaged to Connector
with 4-40 Locknut with Cross Bar

S - Swaged Spacer, 4-40 Threads, 0.250 [6.35] Length, Spacer length
changes to 0.265 [6.73] when used in conjunction with Code 93
contacts

S2 - Swaged Spacer, 4-40 Threads, 0.125 [3.18] Length

S5 - Swaged Locknut, 4-40 Threads

S6 - Swaged Spacer with Push-on Fastener, 4-40 Threads, 0.250 [6.35]
Length

*2 STEP 10 - SPECIAL OPTIONS

FOR SPECIAL OPTIONS, SEE
SPECIAL OPTIONS APPENDIX
ON PAGE 81.

CONTACT TECHNICAL SALES
FOR ORDERING DETAILS OF
THE FOLLOWING:

Other Special Requirements.
Straight and Right Angle Thermocouple
PCB mount contacts

STEP 9 - ENVIRONMENTAL COMPLIANCE OPTIONS

/AA - RoHS Compliant

NOTE: If compliance to environmental
legislation is not required, this step will not be
used. Example: CBDD8W2M93S000

STEP 8 - SHELL OPTIONS

0 - Zinc Plated, with Chromate Seal.

*4 S - Stainless Steel, passivated.

X - Tin Plated.

Z - Tin Plated and Dimpled (male connectors only).

*2 STEP 7 - LOCKING AND POLARIZING SYSTEMS

0 - None.

V3 - Lock Tab, connector front panel mounted.

V5 - Lock Tab, connector rear panel mounted.

VL - Lock Lever, used with Hoods only.

T - Fixed Female Jackscrews.

T2 - Fixed Female Jackscrews.

T6 - Fixed Male and Female Polarized Jackscrews.

E - Rotating Male Jackscrews.

E2 - Rotating Male Screw Locks.

E3 - Rotating Male with Internal Hex for 3/32 Hex Drives

E6 - Rotating Male and Female Polarized Jackscrews.

*2 STEP 6 - HOODS AND PUSH-ON FASTENERS

0 - None

AN - Lightweight Aluminum Hood, nickel finish

AC - Lightweight Aluminum Hood, no finish

H - Hood, Top Opening, Metal

*3 G - Hood, EMI/RFI, Die Cast Zinc

N - Push-on Fastener, for Right Angle (90°) Mounting Brackets

Z - Hood, Top or Side Opening, robust extended height, plastic
and composite, with rotating male jackscrews

NOTES

*1 Power contacts are always supplied with "Closed Entry" female contacts.

*2 For additional information on accessories listed in steps
5, 6, 7 and 10, see Accessory Catalog.

*3 When using G hood with CBDD variants, use the extended height hood.
See Accessories Catalog for extended G hood options.

*4 For stainless steel dimpled male versions, contact Technical Sales.

*5 Size 16 power contact are included.

DIMENSIONS ARE IN INCHES [MILLIMETERS].

37 ALL DIMENSIONS ARE SUBJECT TO CHANGE.



ORDERING INFORMATION - CODE NUMBERING SYSTEM

Specify Complete Connector By Selecting An Option From Step 1 Through 8

FOR CONNECTORS INCLUDING SIZE 8 CONTACTS

STEP	1	2	3	4	5	6	7	8	9	10
EXAMPLE	CBDD	19W1	M	93	S	0	0	0	/AA	-14
STEP 1 - BASIC SERIES CBDD Series - CBHD Series - High Conductivity Power Contacts										*3 STEP 10 - SPECIAL OPTIONS FOR SPECIAL OPTIONS, SEE SPECIAL OPTIONS APPENDIX ON PAGE 81. CONTACT TECHNICAL SALES FOR ORDERING DETAILS OF THE FOLLOWING: Other Special Requirements. Straight and Right Angle Thermocouple PCB mount contacts
STEP 2 - CONNECTOR VARIANTS Shell Size 2 - 19W1 *6 Shell Size 3 - 15W4 *1 Shell Size 4 - 45W2										STEP 9 - ENVIRONMENTAL COMPLIANCE OPTIONS /AA - RoHS Compliant NOTE: If compliance to environmental legislation is not required, this step will not be used. Example: CBDD8W2M93S000
STEP 3 - CONNECTOR GENDER *2 F - Female - Professional Level - Open Entry Signal Contacts M - Male *2 S - Female - Industrial / Military Level - PosiBand Closed Entry Signal Contacts										STEP 8 - SHELL OPTIONS 0 - Zinc Plated, with Chromate Seal. *5 S - Stainless Steel, passivated. X - Tin Plated. Z - Tin Plated and Dimpled (male connectors only).
STEP 4 - CONTACT TERMINATION TYPE 21 - Fixed Solder Cup, 22 AWG-30 AWG [0.3mm ² -0.05mm ²]. 3 - Solder, Straight Printed Board Mount with Signal Contacts 0.170 [4.32] Tail Length. 35 - Solder, Straight Printed Board Mount with Signal and 0.078 [1.98] Ø Power Contacts, 0.170 [4.32] Tail Length. 36 - Solder, Straight Printed Board Mount with Signal and 0.094 [2.39] Ø Power Contacts, 0.170 [4.32] Tail Length. 37 - Solder, Straight Printed Board Mount with Signal and 0.125 [3.18] Ø Power Contacts, 0.170 [4.32] Tail Length. 4 - Solder, Right Angle (90°) Printed Board Mount with Signal Contacts, 0.314 [7.98] Signal Contact Extension. 45 - Solder, Right Angle (90°) Printed Board Mount with Signal and 0.078 [1.98] Ø Power Contacts, 0.314 [7.98] Signal Contact Extension. 47 - Solder, Right Angle (90°) Printed Board Mount with Signal and 0.125 [3.18] Ø Power Contacts, 0.314 [7.98] Signal Contact Extension. 65 - Solder, Straight Printed Board Mount with Signal and Shielded Contacts MDS/FDS 4201D footprint, 0.170 [4.32] Signal Contact Tail Length. 84 - Solder, Right Angle (90°) Printed Board Mount with Signal and Shielded Contacts MRT/FRT 4201D footprint, 0.314 [7.98] Signal Contact Extension. 93 - Signal Omega type compliant and Power Bi-Spring type compliant, termination length 0.225 [5.72].										*3 STEP 7 - LOCKING AND POLARIZING SYSTEMS 0 - None. V3 - Lock Tab, connector front panel mounted. V5 - Lock Tab, connector rear panel mounted. VL - Lock Lever, used with Hoods only. T - Fixed Female Jackscrews. T2 - Fixed Female Jackscrews. T6 - Fixed Male and Female Polarized Jackscrews. E - Rotating Male Jackscrews. E2 - Rotating Male Screw Locks. E3 - Rotating Male with Internal Hex for 3/32 Hex Drives E6 - Rotating Male and Female Polarized Jackscrews.
*3 STEP 5 - MOUNTING STYLE 0 - Mounting Hole, 0.120 [3.05] Ø 02 - Mounting Hole, 0.154 [3.91] Ø B3 - Bracket, Mounting, Right Angle (90°) Metal with Cross Bar B8 - Bracket, Mounting, Right Angle (90°) Plastic with Cross Bar F - Float Mounts, Universal P - Threaded Post, Brass, 0.250 [6.35] Length P2 - Threaded Post, Nylon, 0.250 [6.35] Length R2 - Bracket, Mounting, Right Angle (90°) Metal, Swaged to Connector with 4-40 Thread Fixed Female Jackscrews with Cross Bar R6 - Bracket, Mounting, Right Angle (90°) Metal, Swaged to Connector with 0.120 [3.05] Ø Mounting Hole with Cross Bar R7 - Bracket, Mounting, Right Angle (90°) Metal, Swaged to Connector with 4-40 Threads with Cross Bar R8 - Bracket, Mounting, Right Angle (90°) Metal, Swaged to Connector with 4-40 Locknut with Cross Bar S - Swaged Spacer, 4-40 Threads, 0.250 [6.35] Length, Spacer length changes to 0.265 [6.73] when used in conjunction with Code 93 contacts S2 - Swaged Spacer, 4-40 Threads, 0.125 [3.18] Length S5 - Swaged Locknut, 4-40 Threads S6 - Swaged Spacer with Push-on Fastener, 4-40 Threads, 0.250 [6.35] Length										*3 STEP 6 - HOODS AND PUSH-ON FASTENERS 0 - None AN - Lightweight Aluminum Hood, nickel finish AC - Lightweight Aluminum Hood, no finish H - Hood, Top Opening, Metal *4 G - Hood, EMI/RFI, Die Cast Zinc N - Push-on Fastener, for Right Angle (90°) Mounting Brackets Z - Hood, Top or Side Opening, robust extended height, plastic and composite, with rotating male jackscrews
										NOTES *1 45W2 variant currently available in male only. *2 Power contacts are always supplied with "Closed Entry" female contacts. *3 For additional information on accessories listed in steps 5, 6, 7 and 10, see Accessory Catalog. *4 When using G hood with CBDD variants, use the extended height hood. See Accessories Catalog for extended G hood options. *5 For stainless steel dimpled male versions, contact Technical Sales. *6 For technical, dimensional and PCB layout information on 15W4 variants, contact Technical Sales.



Positronic
connectpositronic.com

PROFESSIONAL, INDUSTRIAL AND MILITARY QUALITY
THREE PERFORMANCE LEVELS FOR BEST COST/PERFORMANCE RATIO
HIGH DENSITY CRIMP / SOLDER REMOVABLE CONTACTS

Combo-D
D-Sub

Size 22 Removable Signal and Thermocouple Crimp Contacts

Size 16 Removable Power Contacts

Size 8 Removable Power, Shielded, Air and High Voltage Contacts

UL and CSA Recognition, for status contact Technical Sales

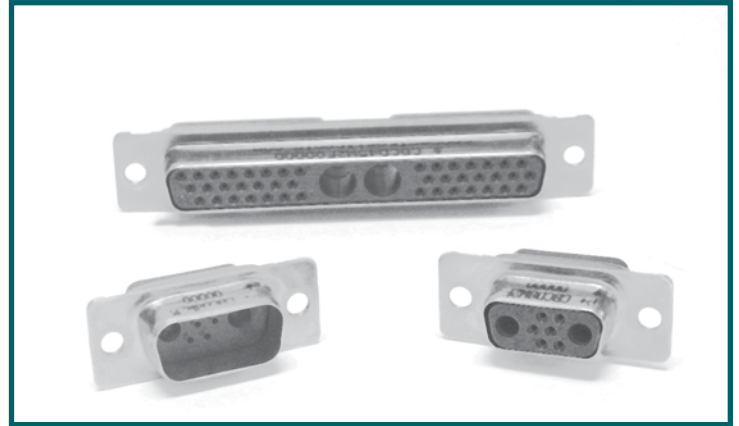

CBCD high density series connectors are quality connectors designed for use in sheltered, mildly corrosive environments having a wide range of temperature, pressure and humidity changes. CBCD series connectors offer mixed crimp-removable contact combinations of power, signal, and thermocouple contacts within the same connector body.

A wide assortment of cable support hoods and locking systems is available from stock.

CBCD series connectors also offer a blind mating connector system for applications requiring connector couplings in recessed areas or for mobile power coupling systems.

CBCD series connectors utilize precision machined contacts and meet applicable performance and dimensional requirements of IEC 60807-7, MIL-DTL-24308 and AS39029.

TECHNICAL CHARACTERISTICS

MATERIALS AND FINISHES:

Insulator:	Glass filled polyester per ASTM D 5927 UL 94V-0, blue color.
Contacts:	Precision machined copper alloy.
Contact Plating:	
SIGNAL:	Gold flash over nickel plate and gold 0.000050 [1.27µ] over nickel plate. Other finishes available upon request, see page 81.
POWER:	Gold flash over nickel. Other finishes available upon request, see page 81.
SHIELDED:	For contact platings, see page 68.
HIGH VOLTAGE:	For contact platings, see page 68.
Shells:	Steel with tin plate; zinc plate with chromate seal; stainless steel passivated. Other materials and finishes available upon request.
Mounting Spacers:	Copper alloy or steel with zinc plate and chromate seal or tin plate; stainless steel, passivated.
Jackscrew Systems:	Brass or steel with zinc plate and chromate seal or clear zinc plate or tin plate; stainless steel, passivated.
Hoods:	Composite and plastic, UL 94V-0; brass or steel with zinc plate and chromate seal. Aluminum; aluminum with electroless nickel plate. For aluminum hoods, zinc content is 1% maximum. Die cast zinc.

Non-magnetic versions are available, contact Technical Sales.
MECHANICAL CHARACTERISTICS:

Signal Contacts,

Crimp Removable:

Size 22 contacts, male – 0.030 inch [0.76mm] mating diameter. Terminations for 20, 22, 24, 26, 28 and 30 AWG. Female PosiBand closed entry design, see page 69 for details. Closed crimp barrel.

Power Contacts,

Crimp Removable:

Size 16 contacts, male – 0.0625 inch [1.588mm] mating diameter. Terminations for 12, 14, 16, 18, 20, 22, and 24 AWG. Female closed entry design. Closed crimp barrel.

Size 8 contacts, male – 0.142 inch [3.61mm] mating diameter. Terminations for 6, 8, 10, 12, and 16 AWG. Female contact features Large Surface Area (L.S.A.) closed entry contact design utilizing BeCu mechanical retention member. Closed crimp barrel.

Contact Retention In Insulator:

SIGNAL SIZE 22

POWER SIZE 16

POWER SIZE 8

9 lbs. [40N].

15 lbs. [67N]

22 lbs. [98N] - power, shielded and high voltage.



TECHNICAL CHARACTERISTICS, continued

continued from previous page. . . .

MECHANICAL CHARACTERISTICS, continued:

Shells:	Male shells may be dimpled for EMI/ESD ground paths.
Polarization:	Trapezoidally shaped shells and polarized jackscrews.
Locking Systems:	Jackscrews and vibration locking systems.
Mechanical Operations:	1000 operations minimum per IEC 60512-5.

ELECTRICAL CHARACTERISTICS:

SIZE 22 CONTACTS

Contact Current Rating:	5 amperes nominal.
Initial Contact Resistance:	0.005 ohms maximum.
Proof Voltage:	1000 V r.m.s.

SIZE 16 CONTACTS

POWER CONTACTS

Contact Current Rating - Tested per UL 1977:

Standard Contact Material:	28 amperes.
High Conductivity Contact Material:	40 amperes.

See Temperature Rise Curves on page 2 for details.

Initial Contact Resistance:

Standard Contact Material:	0.0016 ohms max. Per IEC 60512-2, Test 2b.
----------------------------	--

High Conductivity

Contact Material:	0.001 ohms max. Per IEC 60512-2, Test 2b.
-------------------	---

Proof Voltage:	1000 V r.m.s.
----------------	---------------

SIZE 8 CONTACTS

POWER CONTACTS

For electrical characteristics, see page 4.

SHIELDED CONTACTS

For electrical characteristics, see page 69.

HIGH VOLTAGE CONTACTS

For electrical characteristics, see page 69.

CONNECTOR

Insulation Resistance:	5 G ohms.
Clearance and Creepage Distance:	0.042 inch [1.06mm] minimum.
Working Voltage:	300 V r.m.s.

CLIMATIC CHARACTERISTICS:

Temperature Range:	-55°C to +125°C.
Damp Heat, Steady State:	10 days.

THERMOCOUPLE CONTACTS:

Size 22 crimp contacts are available. See page 71 for details.

PCB mount contacts are available in CBDD series, see page 27 for details.

*1 CONTACT VARIANT

FACE VIEW OF MALE OR REAR VIEW OF FEMALE

Note: Connectors can be kitted with all applicable removable contacts, contact Technical Sales for connector part number.

— SHELL SIZE 1 —

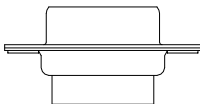
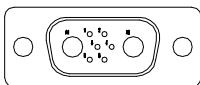

8W2

Six Size 22 Signal Contacts and Two Size 16 Power Contacts

— SHELL SIZE 2 —

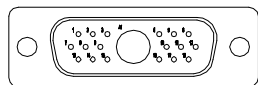

19W1

Eighteen Size 22 Signal Contacts and One Size 8 Power Contact

— SHELL SIZE 4 —

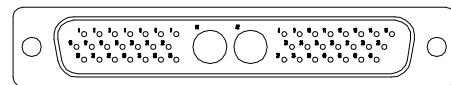

***2 45W2**

Forty-three Size 22 Signal Contacts and Two Size 8 Power Contacts

NOTES:

*1 Additional contact variants may be tooled at customer request.

*2 45W2 variant currently available in female only. Contact Technical Sales for availability of male connector.



Positronic
connectpositronic.com

PROFESSIONAL, INDUSTRIAL AND MILITARY QUALITY
THREE PERFORMANCE LEVELS FOR BEST COST/PERFORMANCE RATIO
HIGH DENSITY CRIMP / SOLDER REMOVABLE CONTACTS

Combo-D
D-Sub

STANDARD SHELL ASSEMBLY

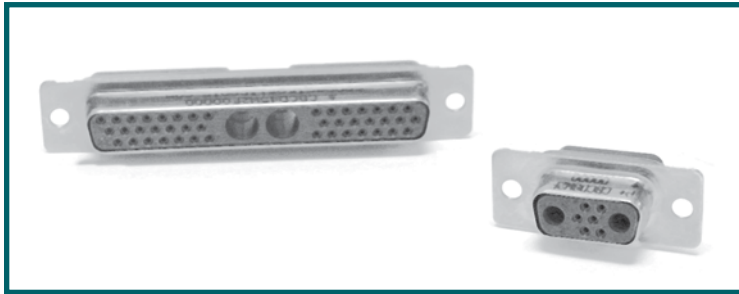

CBCD45W2S00000

CBCD8W2S00000

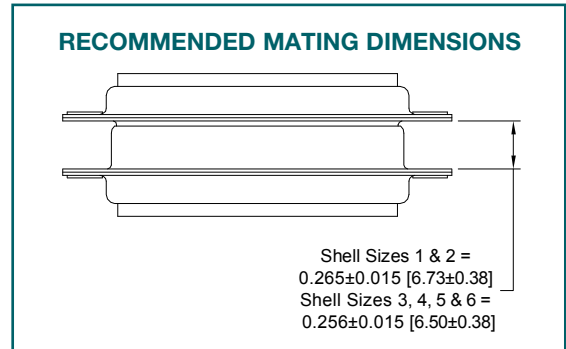

TYPICAL CONNECTOR TOP VIEW

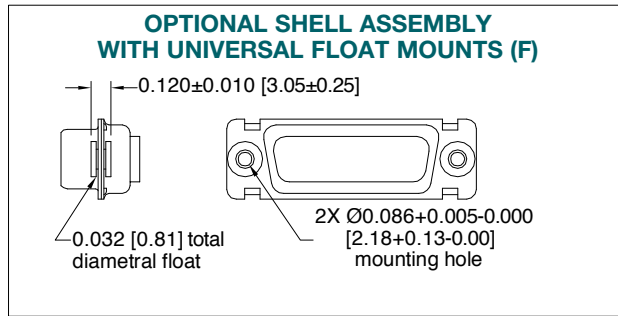
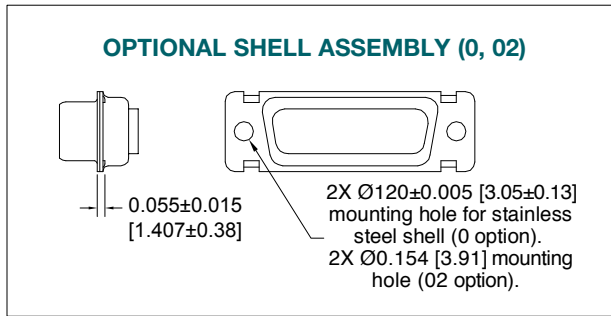
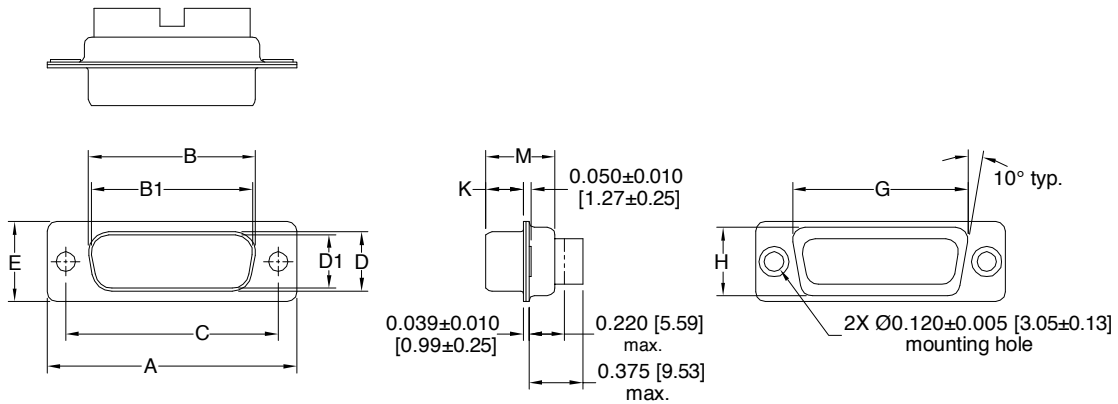

SHELL SIZES	VARIANT	A ±0.015 [0.38]	B ±0.005 [0.13]	B1 ±0.005 [0.13]	C ±0.005 [0.13]	D ±0.005 [0.13]	D1 ±0.005 [0.13]	E ±0.015 [0.38]	G ±0.010 [0.25]	H ±0.010 [0.25]	K ±0.005 [0.13]	M ±0.010 [0.25]
1	8W2M	1.213 [30.81]		0.666 [16.92]	0.984 [24.99]		0.329 [8.36]	0.494 [12.55]	0.759 [19.28]	0.422 [10.72]	0.233 [5.92]	0.422 [10.72]
	8W2S	1.213 [30.81]	0.643 [16.33]		0.984 [24.99]	0.311 [7.90]		0.494 [12.55]	0.759 [19.28]	0.422 [10.72]	0.243 [6.17]	0.429 [10.90]
2	19W1M	1.541 [39.14]		0.994 [25.25]	1.312 [33.32]		0.329 [8.36]	0.494 [12.55]	1.083 [27.51]	0.422 [10.72]	0.233 [5.92]	0.422 [10.72]
	19W1S	1.541 [39.14]	0.971 [24.66]		1.312 [33.32]	0.311 [7.90]		0.494 [12.55]	1.083 [27.51]	0.422 [10.72]	0.243 [6.17]	0.429 [10.90]
4	45W2S	2.729 [69.32]	2.159 [54.84]		2.500 [63.50]	0.311 [7.90]		0.494 [12.55]	2.272 [57.71]	0.422 [10.72]	0.243 [6.17]	0.429 [10.90]



ORDERING INFORMATION - CODE NUMBERING SYSTEM

Specify Complete Connector By Selecting An Option From Step 1 Through 8

STEP	1	2	3	4	5	6	7	8	9	10
EXAMPLE	CBCD	8W2	S	0	0	0	0	S	/AA	-14

STEP 1 - BASIC SERIES

CBCD Series

***3 STEP 10 - SPECIAL OPTIONS**
FOR SPECIAL OPTIONS, SEE
SPECIAL OPTIONS APPENDIX
ON PAGE 81.

STEP 2 - CONNECTOR VARIANTS

Shell Size 1 - 8W2

Shell Size 2 - 19W1

*1 Shell Size 4 - 45W2

STEP 9 - ENVIRONMENTAL COMPLIANCE OPTIONS

/AA - RoHS Compliant

NOTE: If compliance to environmental legislation is not required, this step will not be used. Example: CBCD8W2S0000S

STEP 3 - CONNECTOR GENDER

M - Male

S - Female - PosiBand Closed Entry Signal Contacts

STEP 8 - SHELL OPTIONS

0 - Zinc Plated, with Chromate Seal.

*5 S - Stainless Steel, passivated.

X - Tin Plated.

Z - Tin Plated and Dimpled (male connectors only).

STEP 4 - CONTACT TERMINATION TYPE

0 - Connector ordered without contacts. Order signal, power, thermocouple, shielded, high voltage or air contacts separately. See pages 68-80 for contact part numbers.

1 - Signal contacts, 22 AWG-30 AWG [0.03mm²-0.05mm²].

*2 11 - Signal contacts, 22 AWG-30 AWG [0.03mm²-0.05mm²] with MC/FC 4012D power contact.

*2 12 - Signal contacts, 22 AWG-30 AWG [0.03mm²-0.05mm²] with MC/FC 4016D power contact.

*2 13 - Signal contacts, 22 AWG-30 AWG [0.03mm²-0.05mm²] with MCC/FCC 4101D shielded contacts.

*2 14 - Signal contacts, 22 AWG-30 AWG [0.03mm²-0.05mm²] with MCC/FCC 4102D shielded contacts.

*3 STEP 7 - LOCKING AND POLARIZING SYSTEMS

0 - None.

V3 - Lock Tab, connector front panel mounted.

V5 - Lock Tab, connector rear panel mounted.

VL - Lock Lever, used with Hoods only.

T - Fixed Female Jackscrews.

T2 - Fixed Female Jackscrews.

T6 - Fixed Male and Female Polarized Jackscrews.

E - Rotating Male Jackscrews.

E2 - Rotating Male Screw Locks.

E3 - Rotating Male with Internal Hex for 3/32 Hex Drives

E6 - Rotating Male and Female Polarized Jackscrews.

*3 STEP 6 - HOODS AND PUSH-ON FASTENERS

0 - None

AN - Lightweight Aluminum Hood, nickel finish.

AC - Lightweight Aluminum Hood, no finish.

H - Hood, Top Opening, Metal

*4 G - Hood, EMI/RFI, Die Cast Zinc

Z - Hood, Top or Side Opening, robust extended height, plastic and composite, with rotating male jackscrews

*3 STEP 5 - MOUNTING STYLE

0 - Mounting Hole, 0.120 [3.05] Ø

02 - Mounting Hole, 0.154 [3.91] Ø

F - Float Mounts, Universal

S2 - Swaged Spacer, 4-40 Threads, 0.125 [3.18] Length

S5 - Swaged Locknut, 4-40 Threads

NOTE: If you would like a 2D drawing or 3D model, once you've made your connector selection, please visit www.connectpositronic.com. If you can't find your specific part number on our web site, contact Technical Sales to have one created.

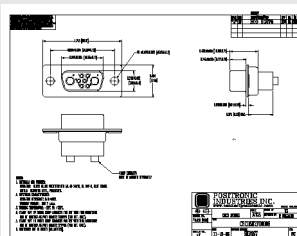

2D Drawing



3D Model

NOTES

*1 45W2 variant currently available in female only.

*2 Available on 19W1 and 45W2 connectors only.

*3 For additional information on accessories listed in steps 5, 6, 7 and 10, see Accessory Catalog.

*4 When using G hood with CBCD variants, use the extended height hood. See Accessories Catalog for extended G hood options.

*5 For stainless steel dimpled male versions, contact Technical Sales.

For crimping information and crimp tools, see Application Tools section, page 82.



Positronic
connectpositronic.com

**PROFESSIONAL, INDUSTRIAL AND MILITARY QUALITY
THREE PERFORMANCE LEVELS FOR BEST COST/PERFORMANCE RATIO
VERTICALLY STACKED STANDARD DENSITY PCB MOUNT**

**Combo-D
D-Sub**

Size 20 Signal Contacts

Size 8 Power Contacts

**UL Recognized
File #E49351**

**CSA Recognized
File #LR54219**

**Telecommunication
UL File #14095**

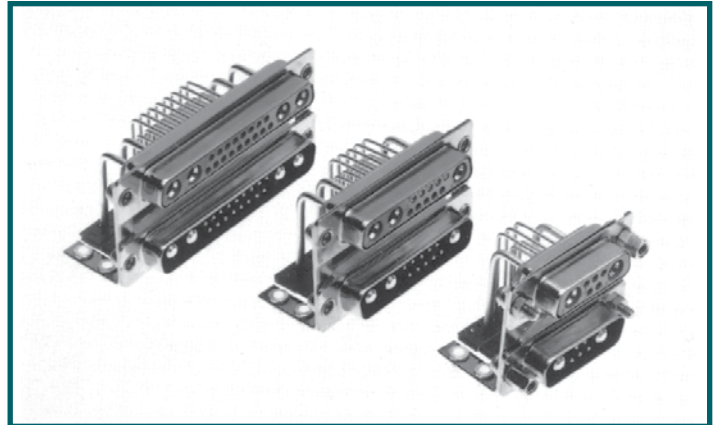

The Combo-Dual Port connector series offers several combinations of power and signal contacts within the same connector assembly. Seventeen different combinations of power and signal contact stacked assemblies are available within four standard shell sizes. The connector assembly can be partially populated with either signal or power contacts installed in the connector bodies to customer selected contact positions. The stacked connectors may be spaced apart to two dimensional spacings.

On special order, the right angle (90°) printed board mount contacts may be replaced with size 8 power,

shielded or high voltage contacts having crimp or solder cup terminations. Signal contacts remain in dual port configuration.

Mounting angle brackets can be ordered riveted to the connector by specifying R2, R6, R7 and R8 options. Locking systems are available utilizing 4-40 threaded jackscrew systems, polarized or non-polarized, or with a quick-release vibration lock system for rear panel mounted connectors.

Combo-Dual Port series connectors comply with the dimensional requirements of IEC 60807-2 and DSCC 85039.

TECHNICAL CHARACTERISTICS

MATERIALS AND FINISHES:

Insulator:	Glass filled polyester per ASTM D 5927 UL 94, blue color, and composite.
Contacts:	Precision machined copper alloy.
Contact Plating:	
SIGNAL:	Gold flash over nickel plate. Other finishes available upon request.
POWER:	Gold flash over nickel. Other finishes available upon request.
Shells:	Steel with tin plate; zinc plate with chromate seal; stainless steel passivated. Other materials and finishes available upon request.
Mounting Spacers and Brackets:	Nylon; polyester; copper alloy or steel with zinc plate and chromate seal or tin plate; phosphor bronze with tin plate; stainless steel, passivated.
Cross Bar:	Nylon, UL 94V-0, black color.
Push-On Fasteners:	Beryllium copper, tin plated.

Jackscrew Systems:	Brass or steel with zinc plate and chromate seal or clear zinc plate or tin plate; stainless steel, passivated.
Vibration Lock Systems:	Lock tabs, steel with nickel plate.
Non-magnetic versions are available, contact Technical Sales.	

MECHANICAL CHARACTERISTICS:

Signal Contacts:	Size 20 contacts, male – 0.040 inch [1.02mm] mating diameter. Female contact – rugged open entry. PosiBand closed entry female options are also available.
Contact Retention In Insulator:	9 lbs. [40N]
Contact Terminations:	Printed board mount with right angle (90°) terminations supported by alignment bar. Termination diameter 0.028 inch [0.71mm].
Power Contacts:	Size 8 contact, male – 0.142 inch [3.61mm] mating diameter.

TECHNICAL CHARACTERISTICS, continued

continued from previous page. . . .

MECHANICAL CHARACTERISTICS, continued:

Contact Retention	
In Insulator:	22 lbs. [98N]
Contact Terminations:	Printed board mount with right angle (90°) terminations of 0.078 inch [1.98mm] diameter.
Shells:	Male connector shells may be dimpled for EMI/ESD ground paths.
Polarization:	Trapezoidally shaped shells and polarized jackscrews.
Mounting Bracket	
Riveted to Connector:	Riveted fasteners with 0.120 inch [3.05mm] diameter clearance hole, with 4-40 threads or 4-40 threads with nylon lock insert.
Mounting To	
Printed Board:	Rapid installation push-on fasteners.
Locking Systems:	Jackscrews and vibration locking system for either front or rear panel mounted connectors.
Mechanical Operations:	500 operations minimum per IEC 60512-5.

ELECTRICAL CHARACTERISTICS:

SIZE 20 CONTACTS

Contact Current Rating:	7.5 amperes nominal.
Initial Contact Resistance:	0.008 ohms maximum.
Proof Voltage:	1000 V r.m.s.

SIZE 8 CONTACTS

POWER CONTACTS

Electrical characteristics for 0.078 inch diameter terminations, see page 4.

CONNECTOR

Insulation Resistance:	5 G ohms.
Clearance and Creepage	
Distance (minimum):	0.039 inch [1.0mm]
Working Voltage:	300 V r.m.s.

CLIMATIC CHARACTERISTICS:

Temperature Range:	-55°C to +125°C.
Damp Heat, Steady State:	10 days.

CONTACT VARIANTS

FACE VIEW OF MALE OR REAR VIEW OF FEMALE

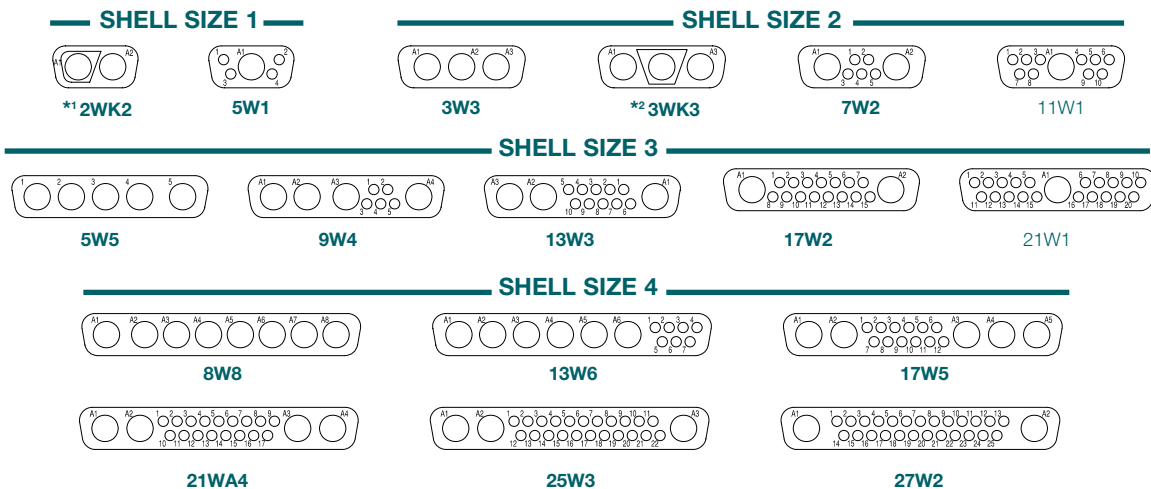

Notes:

- *1 2WK2 connectors have 1 male and 1 female contacts. Female connector should be loaded with female contact in A2 position.
- *2 3WK3 male variant contains 2 male contacts and 1 female contact. Female variant contains 2 female contacts and 1 male contact



Positronic
connectpositronic.com

PROFESSIONAL, INDUSTRIAL AND MILITARY QUALITY
THREE PERFORMANCE LEVELS FOR BEST COST/PERFORMANCE RATIO
VERTICALLY STACKED STANDARD DENSITY PCB MOUNT

Combo-D
D-Sub

RIGHT ANGLE (90°) PRINTED BOARD MOUNT CONNECTOR
4 ROW CONNECTOR UNIT, 0.283 [7.19] CONTACT EXTENSION

See temperature rise curves on pages 1 and 2

NOTE:

30 ampere 0.125 [3.18] Ø power contacts may be ordered at special request for a limited number of CBDP variants. Contact technical sales for details.

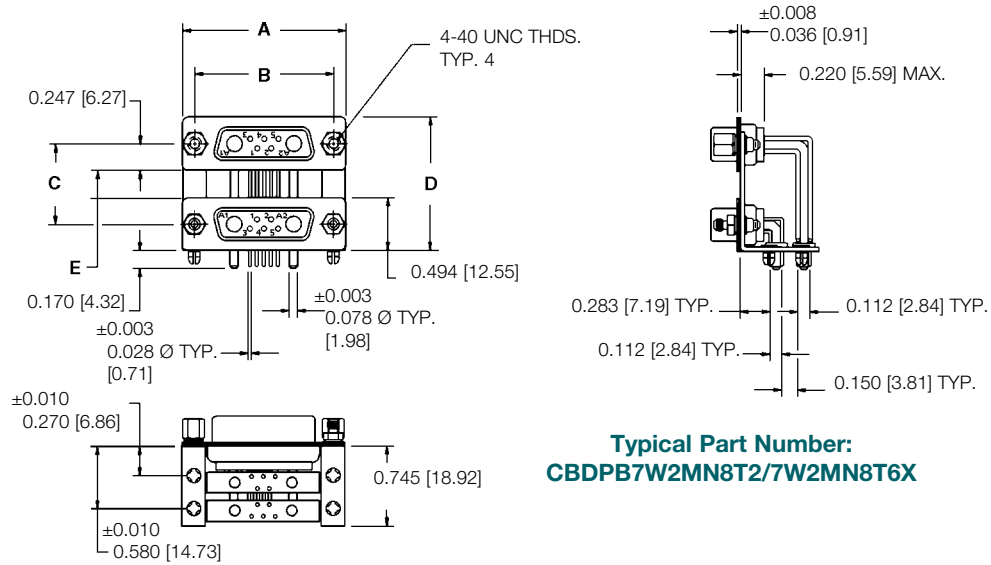

Typical Part Number:
CBDPB7W2MN8T2/7W2MN8T6X

CONNECTOR DESIGNATION	C	D	E
CBDPB	0.750 [19.05]	1.244 [31.60]	0.256 [6.50]
CBDPC	0.900 [22.86]	1.394 [35.41]	0.406 [10.31]

CONNECTOR VARIANT	A	B
SHELL SIZE 1	1.213 [30.81]	0.984 [24.99]
SHELL SIZE 2	1.541 [39.14]	1.312 [33.32]
SHELL SIZE 3	2.088 [53.04]	1.852 [47.04]
SHELL SIZE 4	2.729 [69.32]	2.500 [63.50]

Note: Printed board power contacts (size 8) may be replaced with a size 8 removable power, shielded, air or high voltage contact having solder or crimp terminations.

RIGHT ANGLE (90°) PRINTED BOARD CONTACT HOLE PATTERN

HOLE IDENTIFICATION SHOWN IS FOR FEMALE CONNECTOR OVER MALE CONNECTOR.
MOUNT CONNECTOR WITH MATING FACE POSITIONED TO FOLLOW DIRECTION OF ARROW.

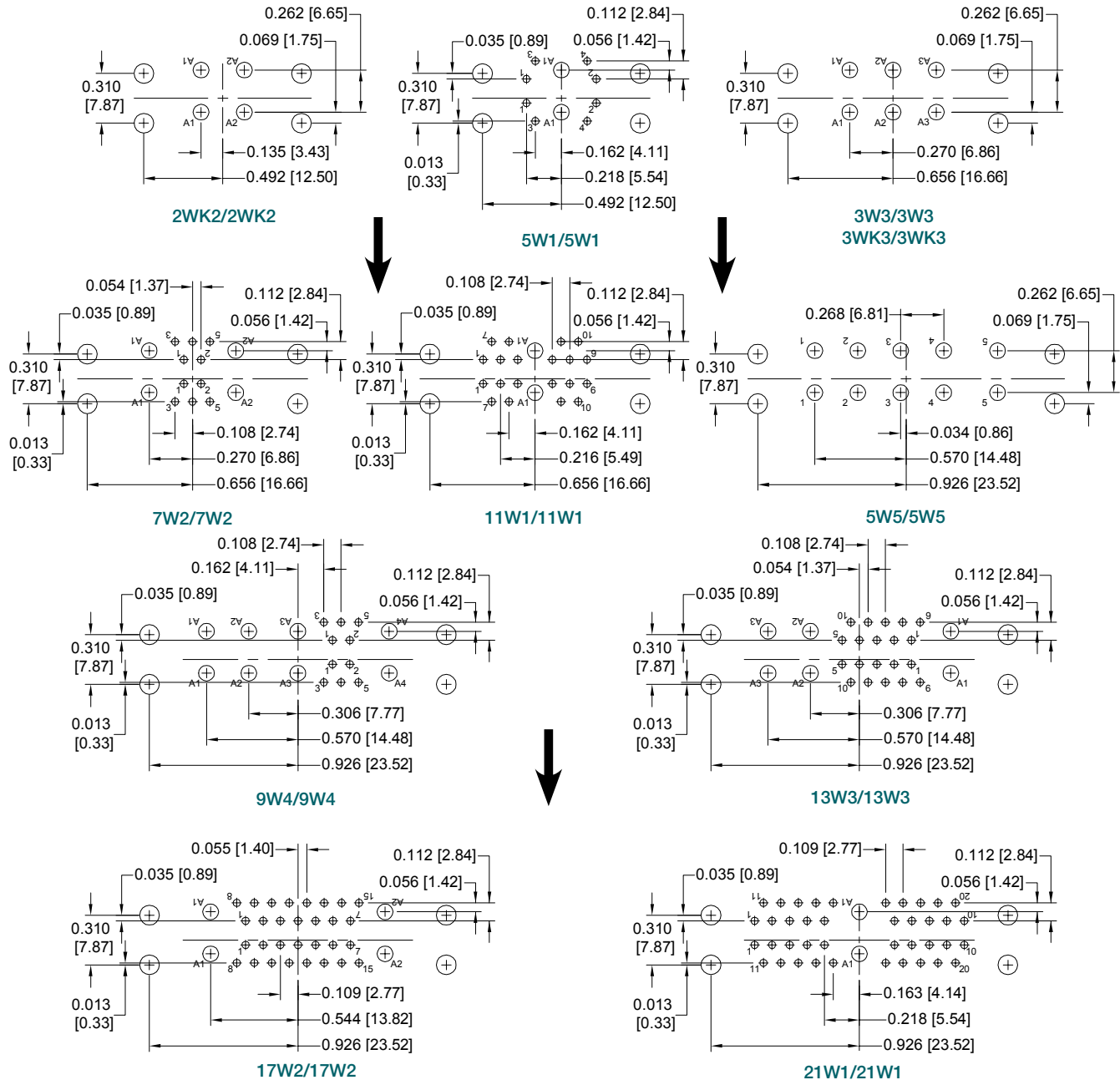

SUGGESTED PRINTED BOARD HOLE SIZES:

Suggest 0.045 [1.14] Ø hole for signal contact termination positions.
Suggest 0.098 [2.49] Ø hole for 0.078 [1.98] Ø power contact termination positions.
Suggest 0.123 ±0.003 [3.12] Ø hole for mounting connector with push-on fasteners.

Mounting holes must move 0.020 [0.51] ±0.010 opposite direction of arrow for use of unriveted mounting bracket with connectors.



Positronic
connectpositronic.com

PROFESSIONAL, INDUSTRIAL AND MILITARY QUALITY
THREE PERFORMANCE LEVELS FOR BEST COST/PERFORMANCE RATIO
VERTICALLY STACKED STANDARD DENSITY PCB MOUNT

Combo-D
D-Sub

RIGHT ANGLE (90°) PRINTED BOARD CONTACT HOLE PATTERN

HOLE IDENTIFICATION SHOWN IS FOR FEMALE CONNECTOR OVER MALE CONNECTOR.
 MOUNT CONNECTOR WITH MATING FACE POSITIONED TO FOLLOW DIRECTION OF ARROW.

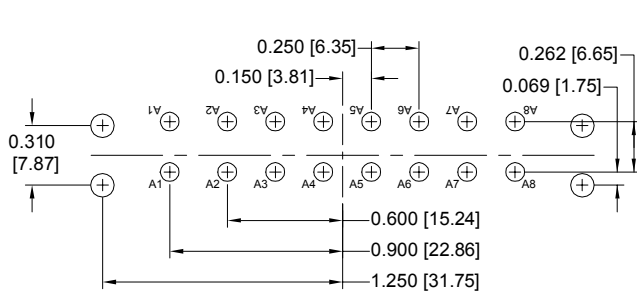

8W8/8W8

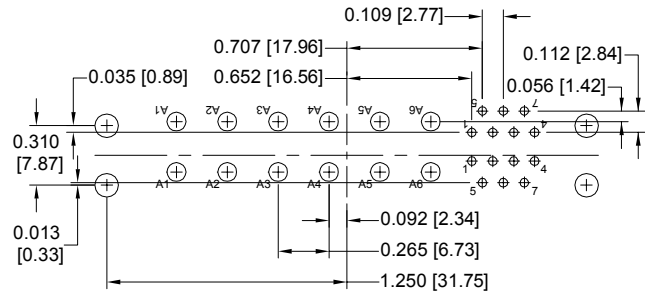

13W6/13W6

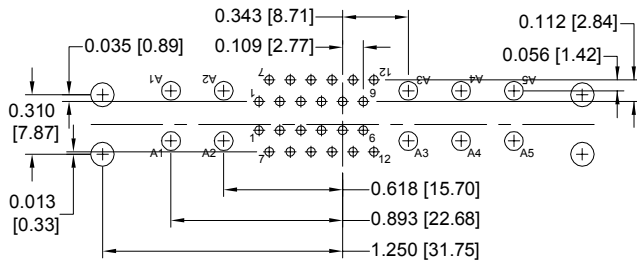

17W5/17W5

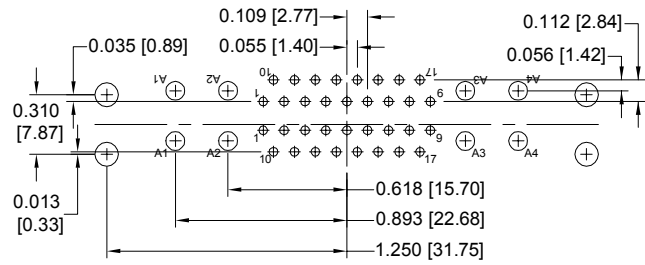

21WA4/21WA4

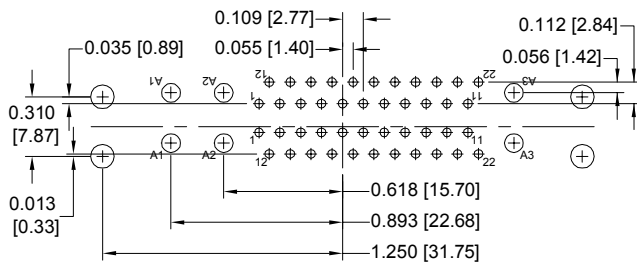

25W3/25W3

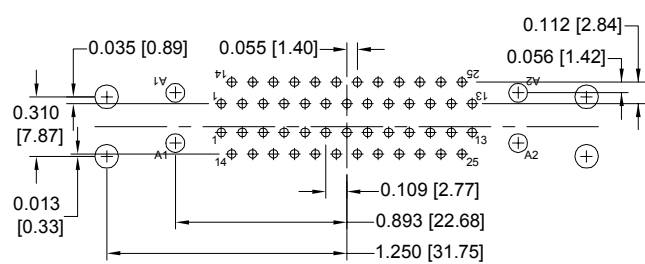

27W2/27W2

SUGGESTED PRINTED BOARD HOLE SIZES:

- Suggest 0.045 [1.14] Ø hole for signal contact termination positions.
- Suggest 0.098 [2.49] Ø hole for 0.078 [1.98] Ø power contact termination positions.
- Suggest 0.123 ±0.003 [3.12] Ø hole for mounting connector with push-on fasteners.

Mounting holes must move 0.020 [0.51] ±0.010 opposite direction of arrow for use of unriveted mounting bracket with connectors.



ORDERING INFORMATION - CODE NUMBERING SYSTEM

Specify Complete Connector By Selecting An Option From Step 1 Through 8

STEP	1	2	3	4	5	6	7	8	9	10
EXAMPLE	CBDPB	9W4	F	N7T	9W4	F	N7T	0	/AA	-14

UPPER CONNECTOR

STEP 1 - BASIC SERIES

- *1 CBDPB Series
- *1 CBDPC Series

STEP 2 - CONNECTOR VARIANTS

Shell Size 1
2WK2, 5W1

Shell Size 2
3W3, 3WK3, 7W2, 11W1

Shell Size 3
5W5, 9W4, 13W3, 17W2, 21W1

Shell Size 4
8W8, 13W6, 17W5, 21WA4, 25W3, 27W2

STEP 3 - CONNECTOR GENDER

- F - Female - Professional Level - Open Entry Signal Contacts
- M - Male
- S - Female - Industrial / Military Level - PosiBand Closed Entry Signal Contacts
Military gold plating is optional.

STEP 4 - LOCKING, POLARIZING, MOUNTING AND PUSH-ON FASTENER SYSTEMS

- 0 - None
- R2 - Bracket, Mounting, Right Angle (90°) Metal, Swaged to Connector with 4-40 Thread, Fixed Female Jackscrews and Cross Bar
- R6 - Bracket, Mounting, Right Angle (90°) Metal, Swaged to Connector with 0.120 [3.05] Ø Mounting Hole with Cross Bar
- R7 - Bracket, Mounting, Right Angle (90°) Metal, Swaged to Connector with 4-40 Threads with Cross Bar
- R8 - Bracket, Mounting, Right Angle (90°) Metal, Swaged to Connector with 4-40 Locknut with Cross Bar
- N2 - Bracket, Mounting, Right Angle (90°) Metal, Swaged to Connector with 4-40 Thread, Fixed Female Jackscrews with Cross Bar and Push-On Fastener
- N6 - Bracket, Mounting, Right Angle (90°) Metal, Swaged to Connector with 0.120 [3.05] Ø Mounting Hole with Cross Bar and Push-on Fastener
- N7 - Bracket, Mounting, Right Angle (90°) Metal, Swaged to Connector with 4-40 Threads with Cross Bar and Push-on Fastener
- N8 - Bracket, Mounting, Right Angle (90°) Metal, Swaged to Connector with 4-40 Locknut with Cross Bar and Push-on Fastener
- V3 - Lock Tab
- V5 - Lock Tab, connector rear panel mounted.
- T - Fixed Female Jackscrews
- T2 - Fixed Female Jackscrews
- T6 - Fixed Male and Female Polarized Jackscrews

LOWER CONNECTOR

OPTIONS ARE THE SAME AS FOR UPPER CONNECTOR STEPS 2, 3, AND 4

STEP 10 - SPECIAL OPTIONS

FOR SPECIAL OPTIONS, SEE SPECIAL OPTIONS APPENDIX ON PAGE 81.

STEP 9 - ENVIRONMENTAL COMPLIANCE OPTIONS

/AA - RoHS Compliant

NOTE: If compliance to environmental legislation is not required, this step will not be used. Example: CBDPB9W4FN7T/9W4FN7T0

STEP 8 - SHELL OPTIONS

- 0 - Zinc Plated, with Chromate Seal.
- *2 S - Stainless Steel, passivated.
- X - Tin Plated.
- Z - Tin Plated and Dimpled (male connectors only)

NOTE

- *1 Contacts can be supplied with Military contact plating, see page 81.
- *2 For stainless steel dimpled male versions, contact Technical Sales.

For crimping information and crimp tools, see Application Tools section, page 82.

NOTE: Size 8 removable power contacts with solder or crimp terminations with power ratings of 10, 20 and 40 amperes may be ordered in lieu of the right angle (90°) board mounted power contact. Removable size 8 shielded, air and high voltage contacts may also be ordered separately in lieu of the power contact. See pages 68-80 for contact part numbers.

NOTE: If you would like a 2D drawing or 3D model, once you've made your connector selection, please visit www.connectpositronic.com. If you can't find your specific part number on our web site, contact Technical Sales to have one created.

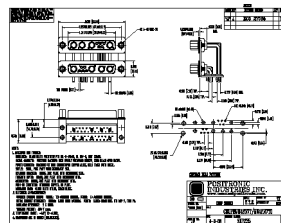

2D Drawing

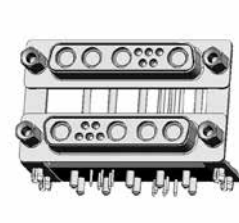

3D Model



Positronic
connectpositronic.com

COMBO-D CONNECTOR SAVERS GENDER CHANGERS

Combo-D
D-Sub

**Professional Quality Connectors
ACBDP Series
Size 20 "Open Entry" or
PosiBand® "Closed Entry"
Contact Design**

**Industrial /Military Quality Connectors
- ACBMP Series
Size 20 PosiBand®
"Closed Entry" Contact Design
Connector Saver**

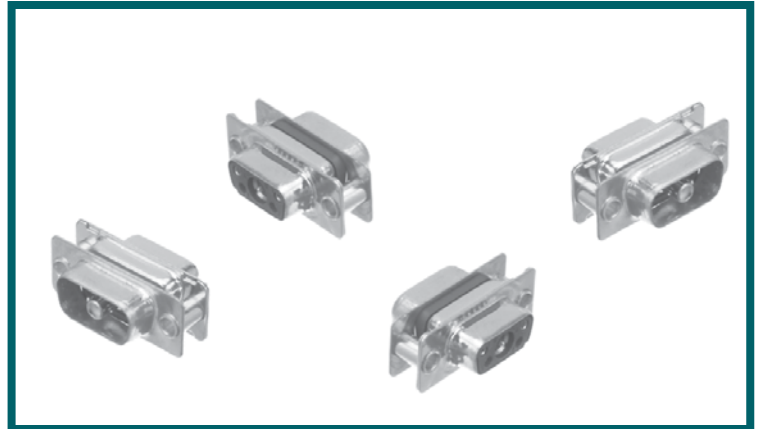

ACBDP and ACBMP series connectors are suitable for use in any applications requiring high performance characteristic. The normal density ACBDP and ACBMP series are available in standard Combo-D connector variants.

ACBDP and ACBMP series connectors utilize precision machined contacts for strength and durability. The ACBDP female contact features a rugged "Open Entry" design or PosiBand "Closed Entry" design for even higher reliability. ACBMP connectors features PosiBand "Closed Entry" contacts and military contact plating.

ACBDP and ACBMP series connectors can be mated to a connector which would normally experience high numbers of mating cycles. The ACBDP/ACBMP connector can be easily replaced, "Saving" a connector which is not easily replaced.

These connectors can also be used as a "gender changer". Connector Savers are also available in standard and high density D-subminiature versions, please consult our Professional, Industrial and Military Performance D-subminiature Connectors catalog for more information.

For high density 8W2, 19W1 and 45W2 adapter variants contact Technical Sales.

TECHNICAL CHARACTERISTICS

MATERIALS AND FINISHES:

Insulator:	Glass filled polyester per ASTM D 5927 UL 94V-0, blue color.
SIGNAL CONTACTS:	
ACBDP Series:	Precision machined high tensile copper alloy open entry design.
ACBMP Series:	Precision machined copper alloy PosiBand closed entry design.
POWER CONTACTS:	Precision machined copper alloy closed entry design.
Contact Plating:	
ACBDP Series:	Gold flash over nickel plate.
ACBMP Series:	0.000050 [1.27µ] gold over nickel plate.
Shells:	Steel with tin plate; zinc plate with chromate seal; stainless steel passivated. Other materials and finishes available upon request.

Jackscrew Systems: Brass or steel with zinc plate and chromate seal or clear zinc plate or tin plate; stainless steel, passivated.

Non-magnetic versions are available, contact Technical Sales.

MECHANICAL CHARACTERISTICS:

FIXED CONTACTS:

SIGNAL CONTACTS: Size 20 contacts, male - 0.040 inch [1.02 mm] diameter. ACBDP series has female open entry contact or PosiBand closed entry contacts optional, see page 69 for details. ACBMP series offer female PosiBand closed entry contacts.

POWER CONTACTS: Size 8 contacts, male - 0.142 inch [3.61 mm] diameter. Female contact features Large Surface Area (L.S.A.) closed entry contact design utilizing BeCu mechanical retention member.



TECHNICAL CHARACTERISTICS, continued

continued from previous page. . . .

MECHANICAL CHARACTERISTICS, continued:

- Connector Saver: Male to female or male to male.
- Contact Retention:
 - Signal: 9 lbs. [40 N].
 - Power: 22 lbs. [98 N].
- Shells: Male shells may be dimpled for EMI/ESD ground paths.
- Polarization: Trapezoidally shaped shells.
- Mechanical Operations:
 - ACBDP Series: 500 operations, minimum, per IEC 60512-5.
 - ACBMP Series: 1,000 operations, minimum, per IEC 60512-5.

ELECTRICAL CHARACTERISTICS:

- SIZE 20 CONTACTS**
 - Contact Current Rating: 7.5 amperes, nominal.
 - Initial Contact Resistance: 0.008 ohms, maximum.
 - Proof Voltage: 1,000 V r.m.s.
- SIZE 8 CONTACTS**
 - POWER CONTACTS**
 - Contact Current Rating: 70 amperes, per UL 1977. See *Temperature Rise Curves* on pages 1-2.
 - Initial Contact Resistance: 0.0005 ohms, maximum
 - Proof Voltage: 1,000 V r.m.s.
- CONNECTOR**
 - Insulation Resistance: 5 G ohms.
 - Clearance and Creepage Distance: 0.039 inch [1.0 mm], minimum.
 - Working Voltage: 300 V r.m.s.
- CLIMATIC CHARACTERISTICS:**
 - Temperature Range: -55°C to +125°C.

CONNECTOR SAVERS

ACBDP/ACBMP SERIES SIZE 20 AND SIZE 8 CONTACT CONNECTOR SAVER

CONTACT VARIANTS

FACE VIEW OF MALE OR REAR VIEW OF FEMALE

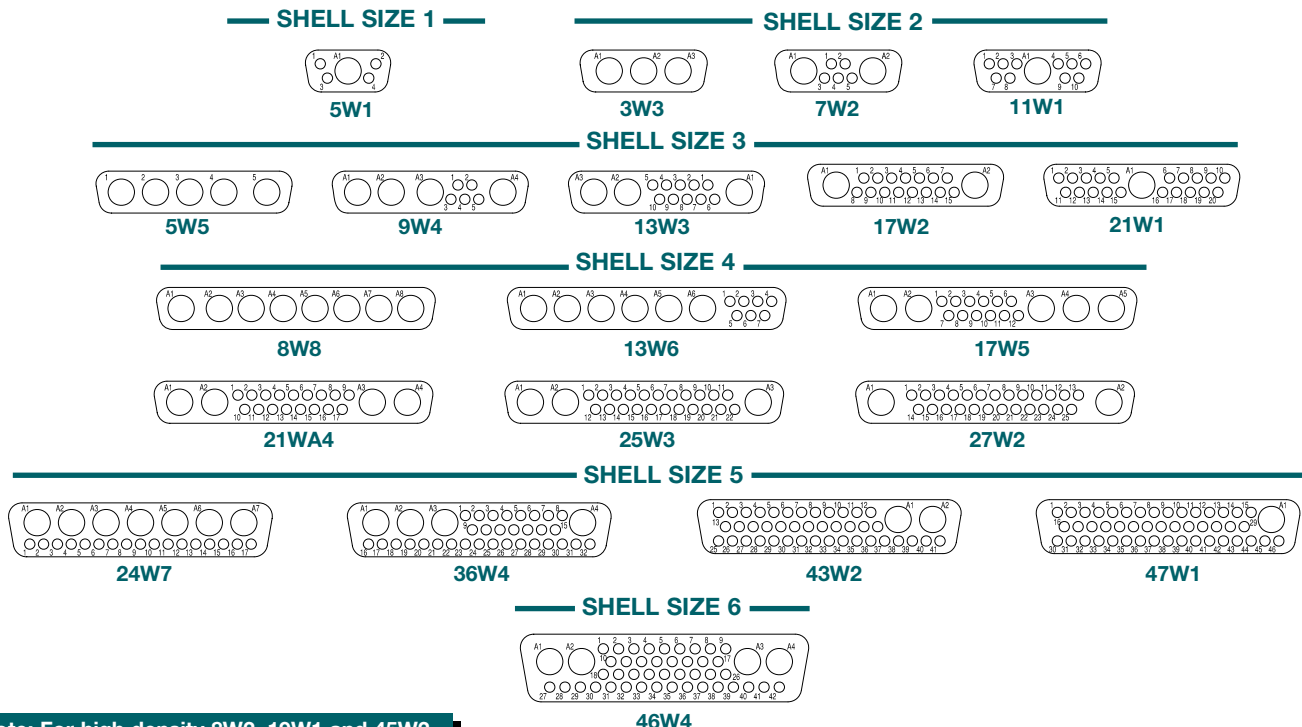

Note: For high density 8W2, 19W1 and 45W2 variants contact Technical Sales for availability.



Positronic
connectpositronic.com

COMBO-D CONNECTOR SAVERS GENDER CHANGERS

Combo-D
D-Sub

STANDARD SHELL ASSEMBLY DIMENSIONS SIZE 20 AND SIZE 8 CONTACTS CODE 0 AND S

NOTE:

Code S = Swaged spacer with 4-40 UNC-2B threads.

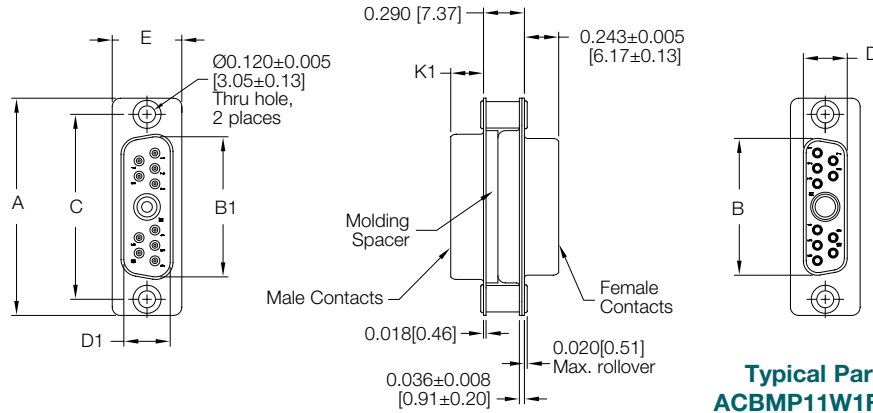

Typical Part Number:
ACBMP11W1F0011W1M00

CONNECTOR SIZE	A ±0.015	B ±0.005	B1 ±0.005	C ±0.005	D ±0.005	D1 ±0.005	E ±0.015	K1 ±0.005
SHELL SIZE 1	1.213 [30.81]	0.643 [16.33]	0.666 [16.92]	0.984 [24.99]	0.311 [7.90]	0.329 [8.36]	0.494 [12.55]	0.233 [5.92]
SHELL SIZE 2	1.541 [39.14]	0.971 [24.66]	0.994 [25.25]	1.312 [33.32]	0.311 [7.90]	0.329 [8.36]	0.494 [12.55]	0.233 [5.92]
SHELL SIZE 3			1.534 [38.96]	1.852 [47.04]	0.311 [7.90]	0.329 [8.36]	0.494 [12.55]	0.230 [5.84]
SHELL SIZE 4	2.729 [69.32]	2.159 [54.84]	2.182 [55.42]	2.500 [63.50]	0.311 [7.90]	0.329 [8.36]	0.494 [12.55]	0.230 [5.84]
SHELL SIZE 5	2.635 [66.93]	2.064 [52.43]	2.079 [52.81]	2.406 [61.11]	0.423 [10.74]	0.441 [11.20]	0.605 [15.37]	0.230 [5.84]
SHELL SIZE 6	2.729 [69.32]	2.189 [55.60]	2.212 [56.18]	2.500 [63.50]	0.485 [12.32]	0.503 [12.78]	0.668 [16.97]	0.230 [5.84]

CONNECTOR SAVERS

JACKSCREW SYSTEMS CODE E, E6, T AND T6

ROTATING
MALE AND FEMALE
JACKSCREWS

ROTATING
MALE AND FEMALE
POLARIZED JACKSCREWS

FIXED
MALE AND FEMALE
JACKSCREWS

FIXED
MALE AND FEMALE
POLARIZED JACKSCREWS

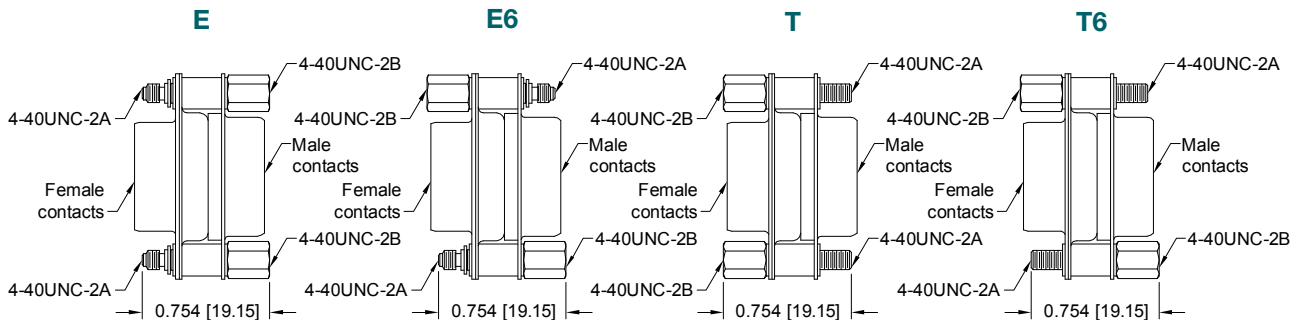

Example Part Number:
ACBDP5W1FEX5W1M0X

Example Part Number:
ACBDP5W1FE6X5W1M0X

Example Part Number:
ACBDP5W1FTX5W1M0X

Example Part Number:
ACBDP5W1FT6X5W1M0X



ORDERING INFORMATION - CODE NUMBERING SYSTEM

Specify Complete Connector By Selecting An Option From Step 1 Through 9

STEP	1	2	3	4	5	6	7	8	9	10	11
EXAMPLE	ACBDP	11W1	F	S	X	11W1	M	S	X	/AA	-14

STEP 1 - BASIC SERIES

ACBDP – Professional / Industrial Quality, see Step 3.
ACBMP – Military conformance with “closed entry” female signal contacts plated 0.000050 [1.27µ] gold over nickel plate. Choose “S” or “M” in Step 3.

STEP 2 - CONNECTOR VARIANT

Shell Size 1
5W1
Shell Size 2
3W3, 7W2, 11W1
Shell Size 3
5W5, 9W4, 13W3, 17W2, 21W1
Shell Size 4
8W8, 13W6, 17W5, 21WA4, 25W3, 27W2
Shell Size 5
24W7, 36W4, 43W2, 47W1
Shell Size 6
46W4

Note: For high density 8W2, 19W1 and 45W2 variants contact Technical Sales for availability.

STEP 3 - 1ST CONNECTOR GENDER

F - Female - Professional Level - Open Entry Signal Contacts
*M - Male
S - Female - Industrial / Military Level - PosiBand Closed Entry Signal Contacts. Military gold plating is optional.

*2 STEP 4 - 1ST CONNECTOR MATING STYLE

0 - Swaged spacer 0.120 [3.05µ] mounting hole
S - Swaged spacer 4-40 UNC-2B threads
*3 E - Rotating male and female jackscrews (Select 0 in Step 8)
*3 E6 - Rotating male and female polarized jackscrew (Select 0 in Step 8)
*3 T - Fixed male and female jackscrews (Select 0 in Step 8)
*3 T6 - Fixed male and female polarized jackscrew (Select 0 in Step 8)

STEP 5 - 1ST CONNECTOR SHELL OPTION

0 – Zinc Plated, with Chromate Seal.
*S – Stainless Steel, passivated.
X – Tin Plated.
Z – Tin Plated and Dimpled (male connectors only).

STEP 11 - SPECIAL OPTIONS

FOR SPECIAL OPTIONS, SEE SPECIAL OPTIONS APPENDIX ON PAGE 81.

STEP 10 - ENVIRONMENTAL COMPLIANCE OPTIONS

/AA - RoHS Compliant

NOTE: If compliance to environmental legislation is not required, this step will not be used. Example: ACBDP11W1FSX11W1MSX

STEP 9 - 2ND CONNECTOR SHELL OPTION

0 – Zinc Plated, with Chromate Seal.
*S – Stainless Steel, passivated.
X – Tin Plated.
Z – Tin Plated and Dimpled (male connectors only).

*2 STEP 8 - 2ND CONNECTOR MATING STYLE

0 - Swaged spacer 0.120 [3.05µ] mounting hole
S - Swaged spacer 4-40 UNC-2B threads
*3 E - Rotating male and female jackscrews (Select 0 in Step 4)
*3 E6 - Rotating male and female polarized jackscrew (Select 0 in Step 4)
*3 T - Fixed male and female jackscrews (Select 0 in Step 4)
*3 T6 - Fixed male and female polarized jackscrew (Select 0 in Step 4)

STEP 7 - 2ND CONNECTOR GENDER

M - Male

*5 STEP 6 - 2ND CONNECTOR VARIANT

Select same variant as chosen in STEP 2.

NOTES

- *1 Male option in Step 3 available only on connector variants 5W1, 3W3, 7W2, 11W1, 17W2, 21W1, 21WA4, 27W2, 24W7, 46W4.
- *2 Connector mating style for both connectors must be the same if 0 or S is used. If E, E6, T or T6 is used in either Step 4 or 8 the other step must be 0.
- *3 For hardware information, see page 59.
- *4 For stainless steel dimpled male versions, contact Technical Sales.
- *5 Connector variant for both connectors must be the same.



Positronic[®]
global connector solutions

Positronic Industries is **known** around the world **for offering** our customers **flexibility** when choosing connectors.

In addition to allowing **customers** to **create** part numbers for **particular applications**, Positronic offers a **wide variety** of features and accessories within our products.

Positronic is also **eager** to modify existing products **to meet unique customer requirements**. If you do not find what you need with this catalog, please **contact us** for assistance.

SEQUENTIAL MATING CONTACTS

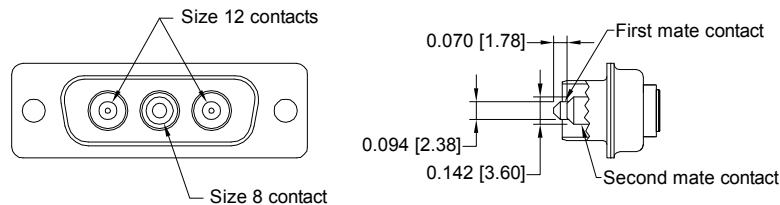

Note: A third level can be accomplished with signal contacts where applicable.

Three levels of sequential mating are possible:

- First mate accomplished by a size 12 power contact. Male contact diameter is 0.094 inch.
- Second mate accomplished by a size 8 power contact. Male contact diameter is 0.142 inch.
- Third mate accomplished by size 20 signal contacts, as applicable.

CONTACT TECHNICAL SALES FOR MORE INFORMATION!

SIZE 8 CONTACT STABILIZATION FEATURE

MINIMIZES FLOAT IN SIZE 8 CONTACT POSITIONS

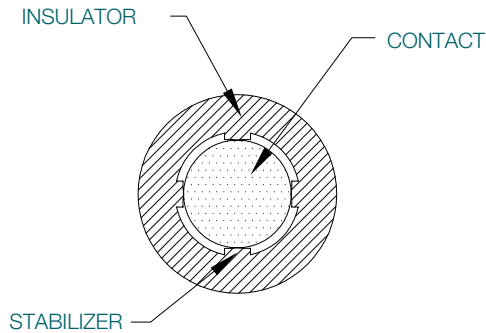

WITH STABILIZER

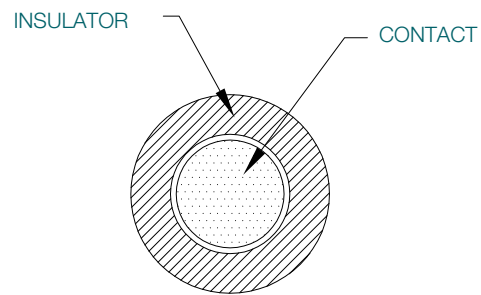

WITHOUT STABILIZER

CBD size 8 male contacts are removed toward the rear after utilizing front release tooling. Space must be provided between the contact and the connector molding so the tooling can slide over the mating portion of the contact. This fact allows the contact to float.

In some applications this float creates problems in alignment during mating. Many male contact CBD variants offer an integral stabilizing feature to minimize problems created by float in size 8 contacts. An alternate tool is used to remove the contact if necessary. Tool number is 4311-0-1-0.

The stabilization feature is currently available for the following male contact variants:

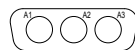

CBD/CBM3W3M

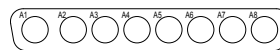

CBD/CBM8W8M

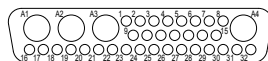

CBC36W4M

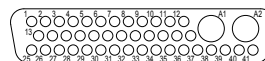

CBC43W2M

Add MOS -1570.4 to end of part number. Example: CBD3W3M00000-1570.4



COMBO-D CONNECTORS WITH *1 100 AMP HIGH CURRENT REMOVABLE CRIMP POWER CONTACT

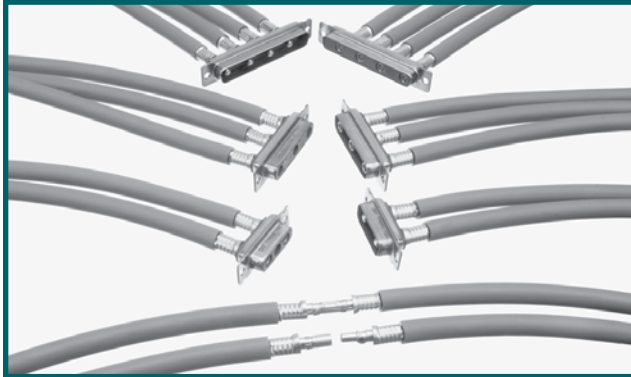

HIGH CONDUCTIVITY SIZE 8 CONTACTS WHICH CAN BE TERMINATED TO 6 AWG WIRE ALLOW VERY HIGH CURRENTS TO BE CARRIED THROUGH COMBO-D TYPE CONNECTORS.

TECHNICAL CHARACTERISTICS

MATERIALS AND FINISHES:

Contacts: High conductivity copper alloy.
Plating:
Standard Finish: Gold flash over nickel plate.
Optional Finishes: 0.000030 [0.76 μ] gold over nickel by adding "-14" suffix onto part number. Example: FC4006D-14
0.000050 inch [1.27μ] gold over nickel by adding "-15" suffix onto part number. Example: MC4006D-14

CLIMATIC CHARACTERISTICS:

Temperature Range: -55°C to +125°C.

*1 per UL 1977 Testing

ELECTRICAL CHARACTERISTICS:

POWER CONTACTS

Contact Current Rating: See Temperature Rise Curve on page 64.
Initial Contact Resistance: 0.0003 ohms max. per IEC 60512-2, Test 2b.
Proof Voltage: 1900 V r.m.s.
Working Voltage: 450 V r.m.s.

MECHANICAL CHARACTERISTICS:

Size 8 Removable Contacts: Rear insertion, front release.
Durability: 500 cycles minimum.
Vibration: 20g from 10 Hz to 500 Hz.
Shock: 30g-11ms.

100 AMP HIGH CURRENT REMOVABLE CRIMP POWER CONTACT

CONTACTS USED WITH 6 AWG WIRE
6 AWG [16.0mm²] max.

*1 CONTACTS ORDERED SEPARATELY
SIZE 8

Note: Connectors can be kitted with all applicable removable contacts, contact Technical Sales for connector part number.

*2 FEMALE CONTACT

"CLOSED ENTRY" DESIGN, L.S.A.

MALE CONTACT

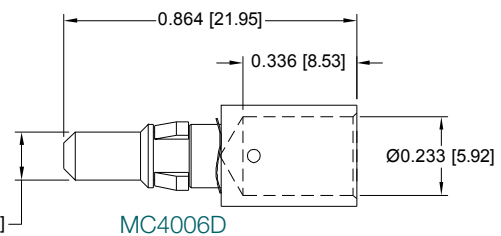
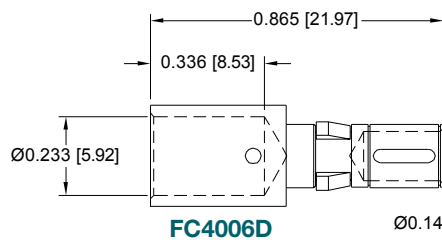
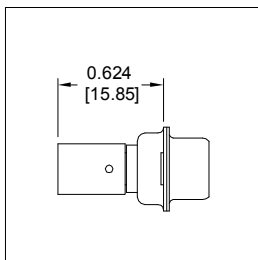

****NOTE:** Female contacts feature Large Surface Area (L.S.A.) closed entry contact design which provides maximum mating surfaces between male and female contact and reduced contact resistance during operation.

MATERIAL: High conductivity copper alloy.

PLATING:

STANDARD FINISH: Gold flash over nickel plate.
OPTIONAL FINISHES: 0.000030 [0.76 μ] gold over nickel by adding "-14" suffix onto part number. Example: FC4006D-14
0.000050 inch [1.27μ] gold over nickel by adding "-15" suffix onto part number. Example: MC4006D-15.



SELECTIVELY LOADED COMBO-D CONNECTORS FOR USE WITH 100 AMP* HIGH CURRENT REMOVABLE CRIMP POWER CONTACT

COMBO-D CONNECTORS WITH TWO CONTACT POSITIONS

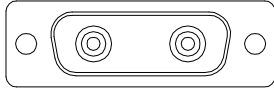

CBD3W3M00000-1841.0

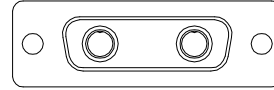

CBD3W3F00000-1841.0

COMBO-D CONNECTORS WITH THREE CONTACT POSITIONS

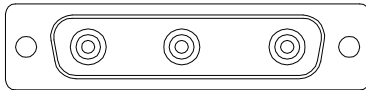

CBD5W5M00000-1841.1

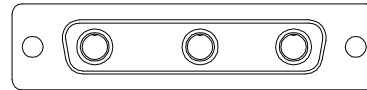

CBD5W5F00000-1841.1

COMBO-D CONNECTORS WITH FOUR CONTACT POSITIONS

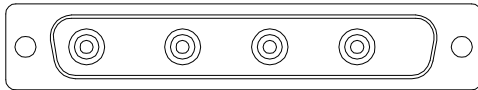

CBD8W8M00000-1841.2

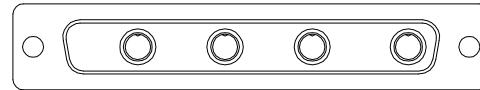

CBD8W8F00000-1841.2

TEMPERATURE RISE CURVE

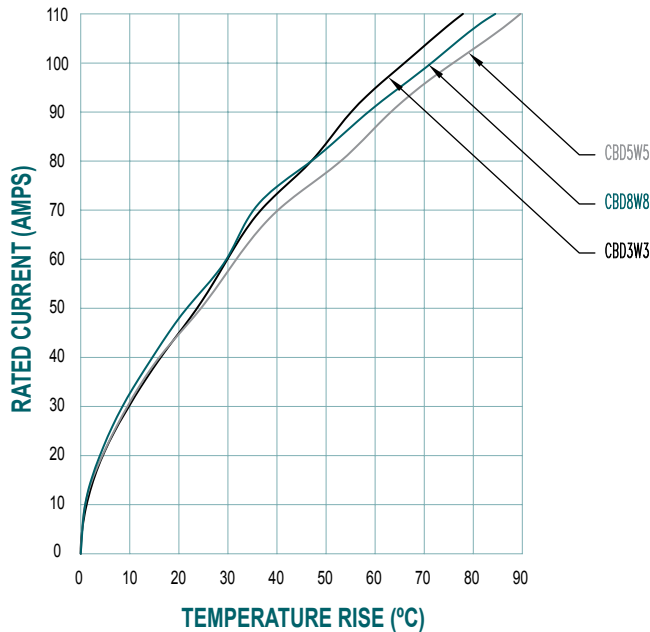

**Test conducted in accordance with UL1977.
All power contacts under load.**

Curves were developed using CBD3W3, 5W5, and 8W8 connectors with MC/FC4006D contacts terminated with 6 AWG wire.



**STRAIGHT PRINTED BOARD MOUNT HIGH VOLTAGE CONTACT
SIZE 8**

FEMALE CONTACT

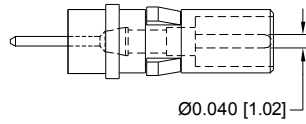

MALE CONTACT

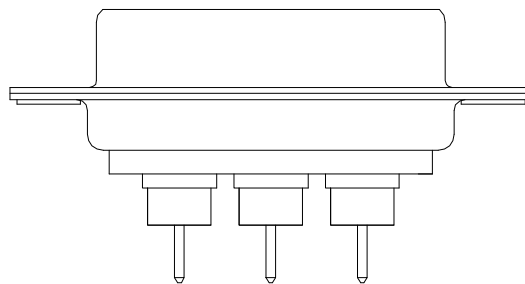
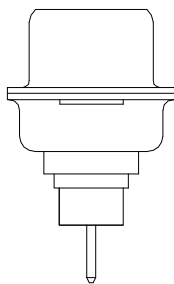
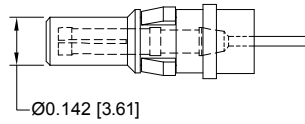

CONTACT TECHNICAL SALES FOR MORE INFORMATION!

**RIGHT ANGLE (90°) PRINTED BOARD MOUNT HIGH VOLTAGE CONTACT
SIZE 8**

FEMALE CONTACT

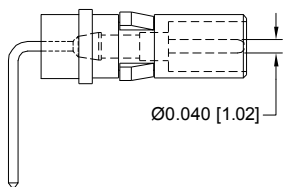

MALE CONTACT

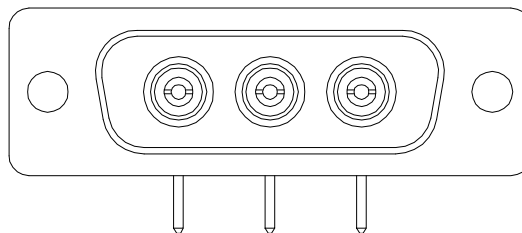
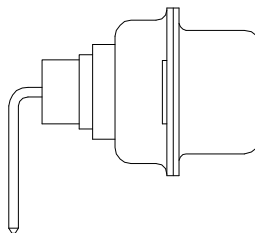
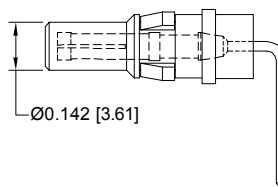

CONTACT TECHNICAL SALES FOR MORE INFORMATION!



**BUS BAR CONTACT
SIZE 8 POWER CONTACT**

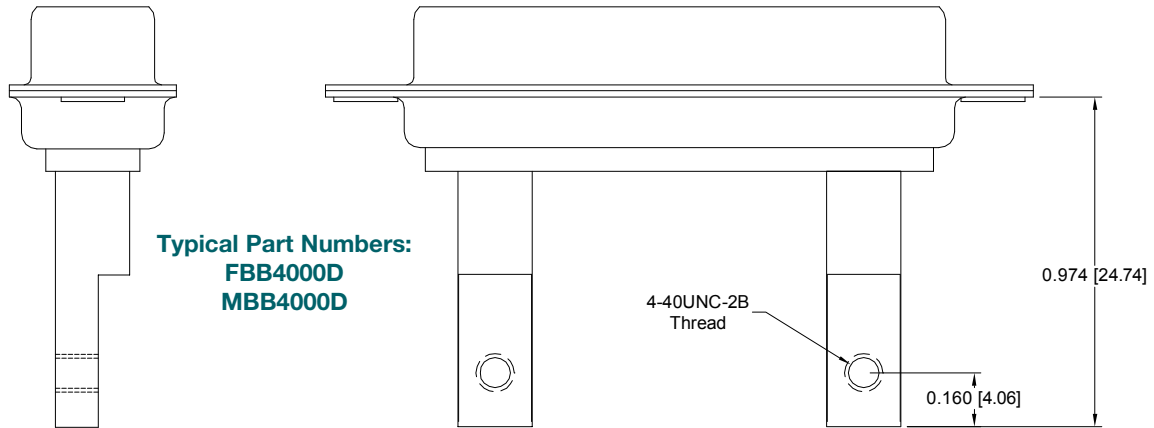

Power contacts can be offered with terminations suitable for use with bus bars.

CONTACT TECHNICAL SALES FOR MORE INFORMATION!



**INTEGRAL BLIND MATE GUIDE
SIZE 8**

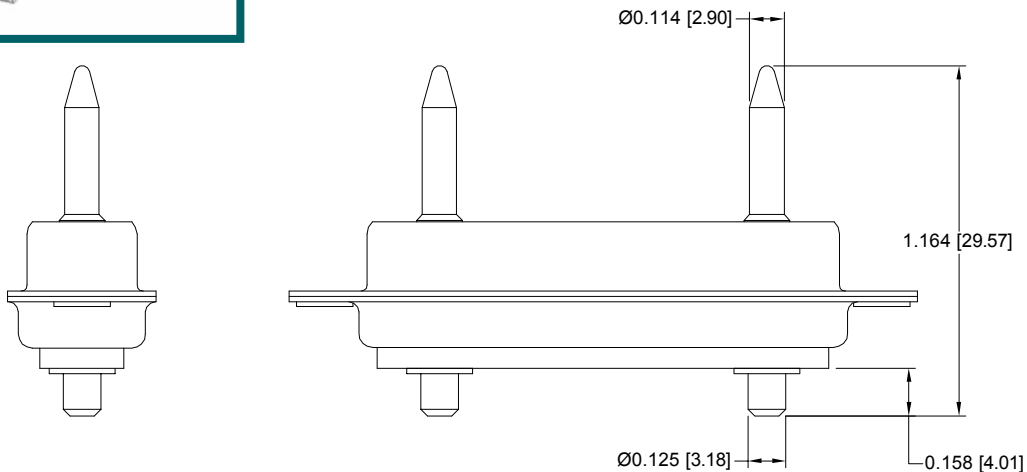

CONTACT TECHNICAL SALES FOR MORE INFORMATION!



CUSTOMER SPECIFIED CONTACT TERMINATION LENGTH

Positronic can supply CB series connectors with customer specified termination lengths. We have a wide variety of options available.

STRAIGHT PRINTED BOARD MOUNT

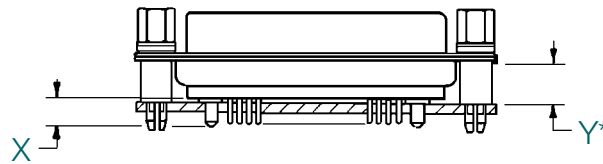

***Note:**

PCB spacer height can be adjusted according to contact termination length

RIGHT ANGLE (90°) PRINTED BOARD MOUNT

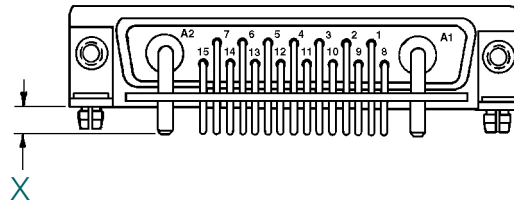

X and Y contact termination lengths can be custom designed to fit your application requirements.

CONTACT TECHNICAL SALES FOR MORE INFORMATION!

Connectors Designed To Customer Specifications

Positronic Combo-D connectors can be modified to customers specifications.

Examples: select loading of contacts for cost savings or to gain creepage and clearance distances; longer PCB terminations; customer specified hardware; sealing for water resistance.

Contact Technical Sales with your particular requirements.



REMOVABLE CONTACT TECHNICAL CHARACTERISTICS

SIZE 22 REMOVABLE CONTACT

MATERIALS AND FINISHES:

Precision machined copper alloy with gold flash over nickel. Other finishes are available, see pages 69 and 81 for optional finishes.

MECHANICAL CHARACTERISTICS:

Insert contact to rear face of insulator, release from rear face of insulator. Size 22 contacts, 0.030 inch [0.76 mm] mating diameter male contacts. Female PosiBand closed entry contact design. Terminations for 20, 22, 24, 26, 28, and 30 AWG. Closed barrel crimp.

ELECTRICAL CHARACTERISTICS:

Contact Current Rating: 5 amperes nominal.
Initial Contact Resistance: 0.010 ohms maximum.

THERMOCOUPLE CONTACTS:

Straight and right angle (90°) PCB mount contacts are available, contact Technical Sales for details.

Size 22 crimp contacts are available, see page 71 for details.

SIZE 20 REMOVABLE CONTACT

MATERIALS AND FINISHES:

Precision machined copper alloy with gold flash over nickel. Other finishes are available, see pages 69 and 81 for optional finishes.

MECHANICAL CHARACTERISTICS:

Insert contact to rear face of insulator, release from rear face of insulator. Size 20 contacts, 0.040 inch [1.02 mm] mating diameter male contacts. Female PosiBand closed entry or rugged open entry contact design.

ELECTRICAL CHARACTERISTICS:

Contact Current Rating: 7.5 amperes nominal.
Initial Contact Resistance: 0.008 ohms max. per IEC 60512-2, test 2b.

THERMOCOUPLE CONTACTS:

Straight and right angle (90°) PCB mount contacts are available, contact Technical Sales for details.

Size 20 crimp contacts are available, see page 74 for details.

SIZE 16 REMOVABLE CONTACT

MATERIALS AND FINISHES:

STANDARD: Precision machined copper alloy with gold flash over nickel. Other finishes are available, see pages 69 and 81 for optional finishes.

HIGH CONDUCTIVITY: High conductivity copper alloy, gold flash over nickel. Other finishes are available, see pages 69 and 81 for optional finishes.

MECHANICAL CHARACTERISTICS:

STANDARD AND

HIGH CONDUCTIVITY: Insert contact to rear face of insulator, release from front face of insulator. Size 16 contacts, 0.0625 inch [1.588mm] mating

diameter male contacts. Female PosiBand closed entry contact design. Terminations for 12, 14, 16, 18, 20, 22, 24, 26, and 28 AWG.

ELECTRICAL CHARACTERISTICS:

Contact Current Rating - Tested per UL 1977:

Standard Contact Material: 28 amperes.

High Conductivity Contact Material: 40 amperes.

See *Temperature Rise Curves on page 2 for details.*

Initial Contact Resistance:

Standard Contact Material: 0.0016 ohms max. Per IEC 60512-2, Test 2b.

High Conductivity

Contact Material: 0.001 ohms max. Per IEC 60512-2, Test 2b.

SIZE 8 REMOVABLE CONTACT

MATERIALS AND FINISHES:

STANDARD:

Precision machined copper alloy with gold flash over nickel. Other finishes are available, see pages 69 and 81 for optional finishes.

HIGH CONDUCTIVITY:

High conductivity copper alloy, gold flash over nickel. Other finishes are available, see pages 69 and 81 for optional finishes.

HIGH VOLTAGE:

Insulator Material: PTFE teflon

Contacts: Precision machined copper alloy with 0.000030 inch [0.76μ] gold over nickel. Other finishes are available, see pages 69 and 81 for optional finishes.

SHIELDED:

Dielectric Material: PTFE teflon

Inner Contacts: Precision machined copper alloy with 0.000030 inch [0.76μ] gold over nickel. Other finishes are available, see pages 69 and 81 for optional finishes.

Outer Contacts:

Precision machined copper alloy with gold flash over nickel. Other finishes are available, see pages 69 and 81 for optional finishes.

AIR LINE COUPLER:

Stainless steel, see page 80.

MECHANICAL CHARACTERISTICS:

STANDARD AND

HIGH CONDUCTIVITY:

Insert contact to rear face of insulator, release from front face of insulator. Size 8 contacts, 0.142 inch [3.61 mm] mating diameter male contacts, closed entry female contacts.

HIGH VOLTAGE:

Insert contact to rear face of insulator, release from front face of insulator. Size 8 contacts. Straight and right angle (90°) terminations. 0.041 inch [1.04 mm] minimum hole diameter.

Durability: 500 cycles minimum.

Vibration: 20g from 10 Hz to 500 Hz.

Shock: 30g-11ms.

... continued on next page

For information regarding crimp tool and crimping tool techniques, see *Application Tools* section, page 82.



REMOVABLE CONTACT TECHNICAL CHARACTERISTICS

continued from previous page . . .

MECHANICAL CHARACTERISTICS, continued:

SHIELDED: Insert contact to rear face of insulator, release from front face of insulator. Size 8 contacts. See page 78 table of cable sizes for contact termination dimensions.

Durability: 500 cycles minimum.
Vibration: 20g from 10 Hz to 500 Hz.
Shock: 30g-11ms.

AIR LINE COUPLER: Insert contact to rear face of insulator, release from front face of insulator.

ELECTRICAL CHARACTERISTICS:

POWER CONTACTS:

For electrical characteristics, see page 4.

HIGH VOLTAGE:

Flash over Voltage: 3600 V r.m.s.
Proof Voltage: 2700 V r.m.s.
Initial Contact Resistance: 0.008 ohms maximum.

SHIELDED:

Initial Contact Resistance: 0.008 ohms maximum.
Nominal Impedance: 50 ohms.
Insertion Loss: -0.46 dB at 1 GHz

VSWR: -1.5 dB at 2 GHz
1.15 average at 1 GHz
1.56 average at 2 GHz
Above values measured using frequency domain techniques.
Proof Voltage: 1000 V r.m.s.

OPTIONAL PLATING FINISHES

-14 0.000030 [0.76 μ] gold over nickel by adding "-14" suffix onto part number. Example: FC120N4-14.
-15 0.000050 inch [1.27μ] gold over nickel by adding "-15". Example: FC120N4-15.

RoHS OPTIONS:

/AA Environmental Compliance Option: RoHS compliant can be achieved by adding "/AA" suffix onto part number. Examples: FC120N4/AA or for optional finishes use FC120N4/AA-14.

What makes Positronic's PosiBand® contact interface significant?

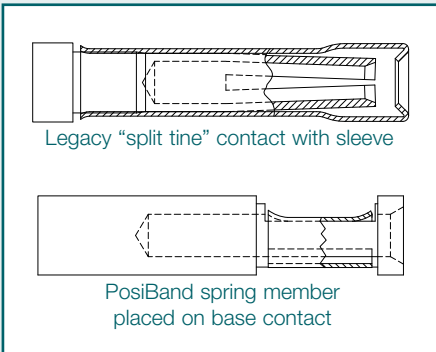

- ✓ Higher reliability in harsh environments and repeated mating cycles.
- ✓ PosiBand crimp contacts do not need to be annealed. Split tine D-subminiature contacts are commonly annealed at the crimp barrel, with the possibility of reliability problems at the contact interface if the annealing is performed incorrectly.
- ✓ Electrical and mechanical function of the contact interface are separated since the PosiBand contact is a two-piece design. Contact normal force is provided by the "Posiband spring member", which allows higher mechanical reliability. The

electrical continuity path is supported through the base contact, which allows a greater number of electrical paths on a "micro" level when compared to split tine contact design.

- ✓ Higher reliability at prices comparable to the "split tine" design.
- ✓ PosiBand is protected by US Patent 7,115,002.

For a detailed white paper visit: www.connectpositronic.com/posiband

For information regarding crimp tool and crimping tool techniques, see Application Tools section, page 82.



REMOVABLE CRIMP SIGNAL CONTACT

FOR USE WITH CBCD SERIES CONNECTORS

SIZE 22

QUALIFIED TO AS39029

Note: Connectors can be kitted with all applicable removable contacts, contact Technical Sales for connector part number.

***MILITARY SPECIFICATION CONTACTS**

STANDARD FINISH:
per AS39029 specifications

COLOR CODE:
MALE CONTACT:
ORANGE/BLUE/BLACK
FEMALE CONTACT:
ORANGE/GREEN/YELLOW

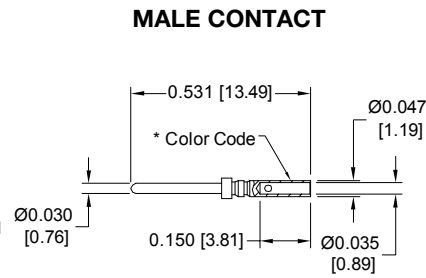
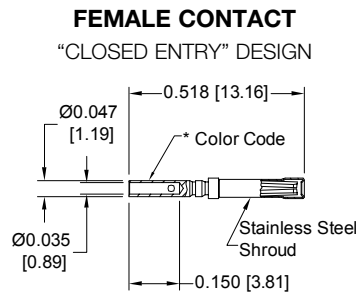

FEMALE PART NUMBER	WIRE SIZE AWG [mm ²]
*M39029/57-354	22 / 24 / 26 / 28 [0.3/0.25/0.12/0.08]

Positronic is qualified to supply the legacy design, as well as, the PosiBand design. If the requirement is for the PosiBand design exclusively, notify sales at time of quotation for order placement when requesting M39029 contacts.

MALE PART NUMBER	WIRE SIZE AWG [mm ²]
*M39029/58-360	22 / 24 / 26 / 28 [0.3/0.25/0.12/0.08]

REMOVABLE CRIMP SIGNAL CONTACT

FOR USE WITH CBCD SERIES CONNECTORS

SIZE 22

Note: Connectors can be kitted with all applicable removable contacts, contact Technical Sales for connector part number.



FEMALE CONTACT
"CLOSED ENTRY" DESIGN

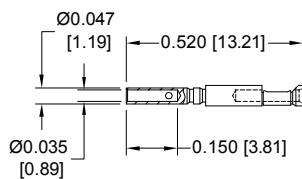

MALE CONTACT

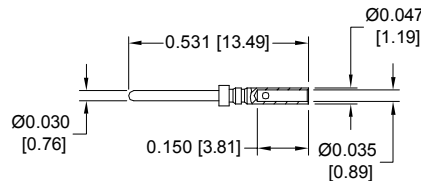

FEMALE PART NUMBER	WIRE SIZE AWG [mm ²]
FC8022D2	22 / 24 / 26 / 28 / 30 [0.3/0.25/0.12/0.08/0.05]

MALE PART NUMBER	WIRE SIZE AWG [mm ²]
MC8022D	22 / 24 / 26 / 28 / 30 [0.3/0.25/0.12/0.08/0.05]

For information regarding crimp tool and crimping tool techniques, see Application Tools section, page 82.



Positronic
connectpositronic.com

REMOVABLE CONTACTS

Combo-D
D-Sub

CRIMP SIGNAL CONTACT FOR USE WITH CBCD SERIES CONNECTORS CONTACTS USED WITH 20 AWG WIRE

SIZE 22



Authentic Positronic®
PosiBand®

These contacts utilize authentic Positronic PosiBand® technology.
Protected by U.S. Patent 7,115,002

Note: Connectors can be kitted with all applicable crimp contacts, contact Technical Sales for connector part number.

The crimp area of these contacts is not protected when fully seated in the connector molding. These contacts require shrink tubing after installation. These contact cannot be removed from connector after installation. Not suitable for fully loaded connector.

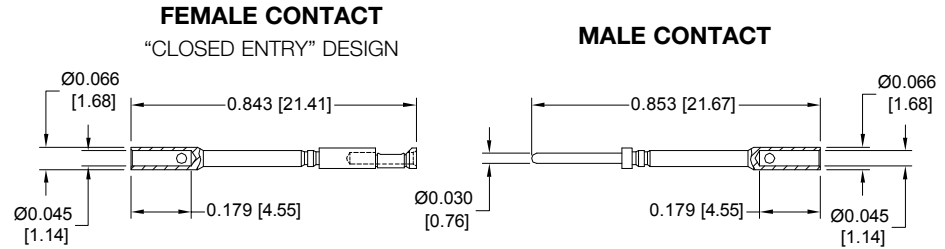

Crimp area extends above connector molding.

FEMALE PART NUMBER	WIRE SIZE AWG [mm ²]
FC8020D2	20 [0.5] max

MALE PART NUMBER	WIRE SIZE AWG [mm ²]
MC8020D	20 [0.5] max

REMOVABLE THERMOCOUPLE SIGNAL CRIMP SIGNAL CONTACT

FOR USE WITH CBCD SERIES CONNECTORS

SIZE 22



Authentic Positronic®
PosiBand®

These contacts utilize authentic Positronic PosiBand® technology.
Protected by U.S. Patent 7,115,002

Note: Connectors can be kitted with all applicable removable contacts, contact Technical Sales for connector part number.

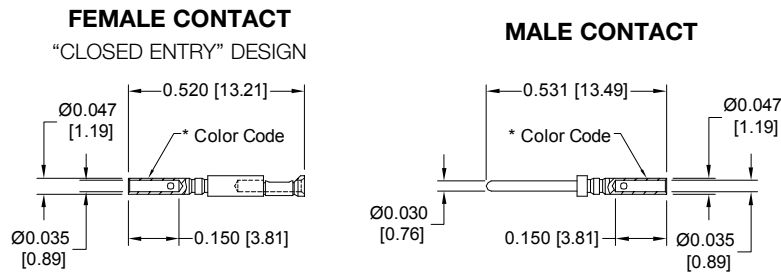

TYPE	MATERIAL	FEMALE PART NUMBER	MALE PART NUMBER	COLOR CODE*	WIRE SIZE AWG [mm ²]
K	CHROMEL (+)	FC8022D2CH	MC8022DCH	WHITE	22 / 24 / 26 [0.3 / 0.25 / 0.12]
	ALUMEL (-)	FC8022D2AL	MC8022DAL	GREEN	22 / 24 / 26 [0.3 / 0.25 / 0.12]
T	COPPER (+) with gold flash	FC8022D2CU	MC8022DCU	RED	22 / 24 / 26 [0.3 / 0.25 / 0.12]
	CONSTANTAN (-)	FC8022D2CO	MC8022DCO	YELLOW	22 / 24 / 26 [0.3 / 0.25 / 0.12]
E	CHROMEL (+)	FC8022D2CH	MC8022DCH	WHITE	22 / 24 / 26 [0.3 / 0.25 / 0.12]
	CONSTANTAN (-)	FC8022D2CO	MC8022DCO	YELLOW	22 / 24 / 26 [0.3 / 0.25 / 0.12]

For more information on the availability of Type J thermocouple contacts, please contact Technical Sales.

For more information about thermocouple contacts with PCB solder termination, please contact Technical Sales.

Chromel® and Alumel® are registered trademarks of Hoskins Manufacturing Company

For information regarding crimp tool and crimping tool techniques, see Application Tools section, page 82.



MILITARY LEVEL REMOVABLE CRIMP SIGNAL CONTACT

FOR USE WITH CBC SERIES CONNECTORS

SIZE 20

QUALIFIED TO AS39029

***MILITARY SPECIFICATION CONTACTS**

STANDARD FINISH:
0.000050 inch [1.27μ] gold over nickel

COLOR CODE:
MALE CONTACT:
ORANGE/BLUE/WHITE
FEMALE CONTACT:
ORANGE/BLUE/GRAY

Note: Connectors can be kitted with all applicable removable contacts, contact Technical Sales for connector part number.

FEMALE CONTACT

"CLOSED ENTRY" DESIGN

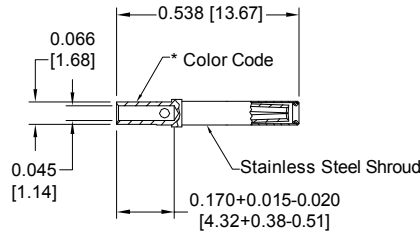

MALE CONTACT

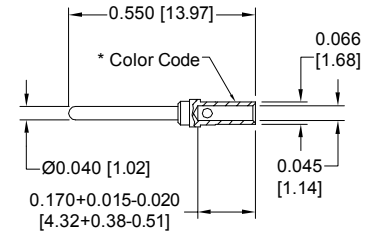

FEMALE PART NUMBER	WIRE SIZE AWG [mm ²]
*M39029/63-368	20 / 22 / 24 [0.5/0.3/0.25]

Positronic is qualified to supply the legacy design, as well as, the PosiBand design. If the requirement is for the PosiBand design exclusively, notify sales at time of quotation for order placement when requesting M39029 contacts.

MALE PART NUMBER	WIRE SIZE AWG [mm ²]
*M39029/64-369	20 / 22 / 24 [0.5/0.3/0.25]

INDUSTRIAL / MILITARY LEVEL REMOVABLE CRIMP SIGNAL CONTACT

FOR USE WITH CBC SERIES CONNECTORS

SIZE 20



Note: Connectors can be kitted with all applicable removable contacts, contact Technical Sales for connector part number.

FEMALE CONTACT

"CLOSED ENTRY" DESIGN

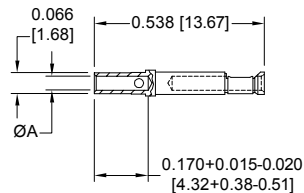

MALE CONTACT

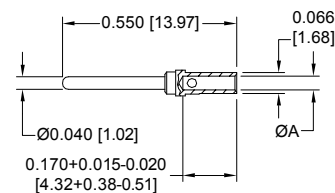

FEMALE PART NUMBER	WIRE SIZE AWG [mm ²]	ØA
FC6020D2	20 / 22 / 24 [0.5/0.3/0.25]	0.045 [1.14]
FC6026D2	26 / 28 / 30 [0.12/0.08/0.05]	0.027 [0.69]

MALE PART NUMBER	WIRE SIZE AWG [mm ²]	ØA
MC6020D	20 / 22 / 24 [0.5/0.3/0.25]	0.045 [1.14]
MC6026D	26 / 28 / 30 [0.12/0.08/0.05]	0.027 [0.69]

For information regarding crimp tool and crimping tool techniques, see Application Tools section, page 82.



INDUSTRIAL / MILITARY LEVEL CRIMP SIGNAL CONTACT

FOR USE WITH CBC SERIES CONNECTORS

CONTACTS USED WITH 18 AWG WIRE

SIZE 20



Note: Connectors can be kitted with all applicable crimp contacts, contact Technical Sales for connector part number.

The crimp area of these contacts is not protected when fully seated in the connector molding. These contacts require shrink tubing after installation. These contact cannot be removed from connector after installation. Not suitable for fully loaded connector.

FEMALE CONTACT

"CLOSED ENTRY" DESIGN

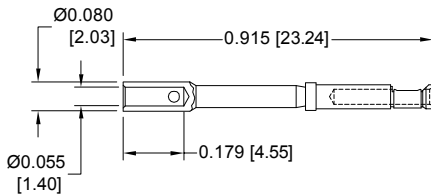

FEMALE PART NUMBER	WIRE SIZE AWG [mm ²]
FC6018D2	18 [1.0] max

MALE CONTACT

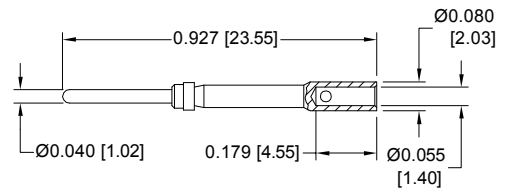

MALE PART NUMBER	WIRE SIZE AWG [mm ²]
MC6018D	18 [1.0] max

PROFESSIONAL LEVEL REMOVABLE CRIMP SIGNAL CONTACT

FOR USE WITH CBC AND QB SERIES CONNECTORS

SIZE 20

FEMALE CONTACT

"RUGGED OPEN ENTRY" DESIGN

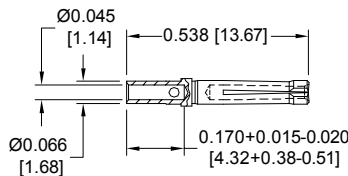

Note: Connectors can be kitted with all applicable removable contacts, contact Technical Sales for connector part number.

FEMALE PART NUMBER	WIRE SIZE AWG [mm ²]
FC6520D	20 / 22 / 24 [0.5/0.3/0.25]

For information regarding crimp tool and crimping tool techniques, see Application Tools section, page 82.



REMOVABLE THERMOCOUPLE CRIMP CONTACT

FOR USE WITH CBC SERIES CONNECTORS

SIZE 20

FEMALE CONTACT

"CLOSED ENTRY" DESIGN

Note: Connectors can be kitted with all applicable removable contacts, contact Technical Sales for connector part number.

MALE CONTACT

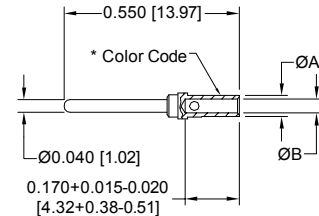
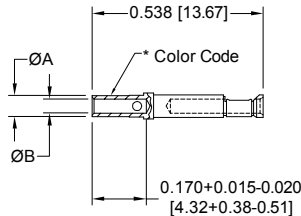

TYPE	MATERIAL	FEMALE PART NUMBER	MALE PART NUMBER	COLOR CODE	WIRE SIZE AWG [mm ²]	ØA	ØB
K	CHROMEL (+)	FC6020D2CH**	MC6020DCH*	WHITE	20 / 22 / 24 [0.5 / 0.3 / 0.25]	0.066 [1.68]	0.045 [1.14]
		FC6026D2CH	MC6026DCH		26 / 28 / 30 [0.12 / 0.08 / 0.05]	0.048 [1.23]	0.027 [0.69]
	ALUMEL (-)	FC6020D2AL**	MC6020DAL*	GREEN	20 / 22 / 24 [0.5 / 0.3 / 0.25]	0.066 [1.68]	0.045 [1.14]
		FC6026D2AL	MC6026DAL		26 / 28 / 30 [0.12 / 0.08 / 0.05]	0.048 [1.23]	0.027 [0.69]
T	COPPER (+) with gold flash	FC6020D2CU**	MC6020DCU*	RED	20 / 22 / 24 [0.5 / 0.3 / 0.25]	0.066 [1.68]	0.045 [1.14]
		FC6026D2CU	MC6026DCU		26 / 28 / 30 [0.12 / 0.08 / 0.05]	0.048 [1.23]	0.027 [0.69]
	CONSTANTAN (-)	FC6020D2CO**	MC6020DCO*	YELLOW	20 / 22 / 24 [0.5 / 0.3 / 0.25]	0.066 [1.68]	0.045 [1.14]
		FC6026D2CO	MC6026DCO		26 / 28 / 30 [0.12 / 0.08 / 0.05]	0.048 [1.23]	0.027 [0.69]
E	CHROMEL (+)	FC6020D2CH**	MC6020DCH*	WHITE	20 / 22 / 24 [0.5 / 0.3 / 0.25]	0.066 [1.68]	0.045 [1.14]
		FC6026D2CH	MC6026DCH		26 / 28 / 30 [0.12 / 0.08 / 0.05]	0.048 [1.23]	0.027 [0.69]
	CONSTANTAN (-)	FC6020D2CO**	MC6020DCO*	YELLOW	20 / 22 / 24 [0.5 / 0.3 / 0.25]	0.066 [1.68]	0.045 [1.14]
		FC6026D2CO	MC6026DCO		26 / 28 / 30 [0.12 / 0.08 / 0.05]	0.048 [1.23]	0.027 [0.69]

For more information on the availability of Type J thermocouple contacts, and information about thermocouple contacts with PCB solder termination, please contact Technical Sales.

Chromel® and Alumel® are registered trademarks of Hoskins Manufacturing Company.

**Dimensionally equivalent to M39029/64-369

**Dimensionally equivalent to M39029/63-368

REMOVABLE CRIMP POWER CONTACT

FOR USE WITH CBCD SERIES CONNECTORS

SIZE 16

*1 FEMALE CONTACT

"CLOSED ENTRY" DESIGN, L.S.A.

Note: Connectors can be kitted with all applicable removable contacts, contact Technical Sales for connector part number.

MALE CONTACT

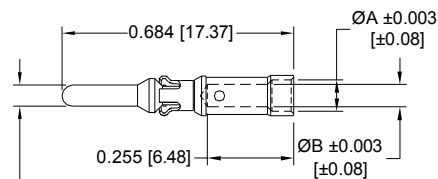
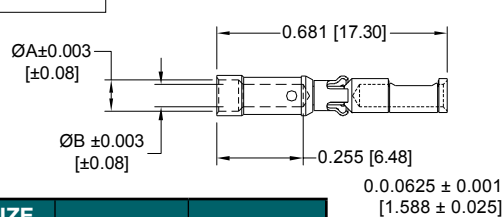

FEMALE PART NUMBER	WIRE SIZE AWG [mm ²]	ØA	ØB
FC112N4S	12 / [4.0]	N/A	0.098 [2.49]
FC112N4	12 / [4.0]	N/A	0.098 [2.49]
FC114N4	14-16 [2.5-1.5]	0.105 [2.67]	0.081 [2.06]
FC116N4	16-18 [1.5-1.0]	0.093 [2.36]	0.067 [1.70]
FC120N4	20-22-24 [0.5-0.3-0.25]	0.068 [1.73]	0.045 [1.14]

"S" in part number indicates high conductivity copper alloy material.

MALE PART NUMBER	WIRE SIZE AWG [mm ²]	ØA	ØB
MC112NS-133.0	12 / [4.0]	N/A	0.098 [2.49]
MC112N-133.0	12 / [4.0]	N/A	0.098 [2.49]
MC114N-133.0	14-16 [2.5-1.5]	0.105 [2.67]	0.081 [2.06]
MC116N-133.0	16-18 [1.5-1.0]	0.093 [2.36]	0.067 [1.70]
MC120N-133.0	20-22-24 [0.5-0.3-0.25]	0.068 [1.73]	0.045 [1.14]

*1 NOTE: Female contacts feature Large Surface Area (L.S.A.) closed entry contact design which provides maximum mating surfaces between male and female contact and reduced contact resistance during operation.

For information regarding crimp tool and crimping tool techniques, see Application Tools section, page 82.



REMOVABLE CRIMP POWER CONTACT

FOR USE WITH CBD, CBC, CBCD AND CBDD SERIES CONNECTORS

SIZE 8

Note: Connectors can be kitted with all applicable removable contacts, contact Technical Sales for connector part number.

For contact current rating, see page 4.

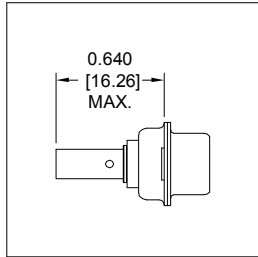

*1 FEMALE CONTACT

"CLOSED ENTRY" DESIGN, L.S.A.

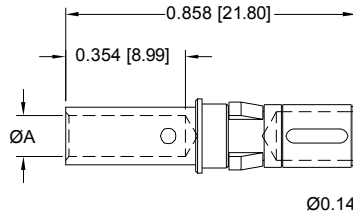

MALE CONTACT

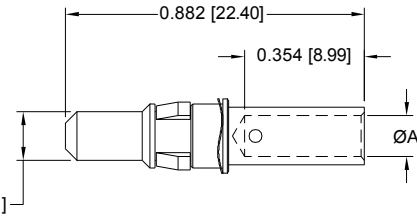

FEMALE PART NUMBER	WIRE SIZE AWG [mm ²]	Ø A
FC4008DS	8 [10.0]	0.181 [4.60]
FC4008D	8 [10.0]	0.181 [4.60]
FC4010D	10 [5.3]	0.122 [3.10]
FC4012D	12 [4.0]	0.101 [2.57]
FC4016D	16 [1.5]	0.067 [1.70]

"S" in part number indicates high conductivity copper alloy material.

MALE PART NUMBER	WIRE SIZE AWG [mm ²]	Ø A
MC4008DS	8 [10.0]	0.181 [4.60]
MC4008D	8 [10.0]	0.181 [4.60]
MC4010D	10 [5.3]	0.122 [3.10]
MC4012D	12 [4.0]	0.101 [2.57]
MC4016D	16 [1.5]	0.067 [1.70]

*1 NOTE: Female contacts feature Large Surface Area (L.S.A.) closed entry contact design which provides maximum mating surfaces between male and female contact and reduced contact resistance during operation.

REMOVABLE SOLDER CUP POWER CONTACT

FOR USE WITH CBD, CBC, CBCD AND CBDD SERIES CONNECTORS

SIZE 8

Note: Connectors can be kitted with all applicable removable contacts, contact Technical Sales for connector part number.

For contact current rating, see page 4.

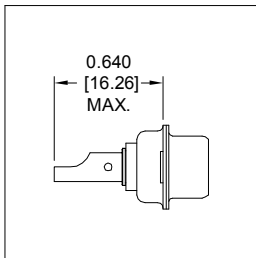

*1 FEMALE CONTACT

"CLOSED ENTRY" DESIGN, L.S.A.

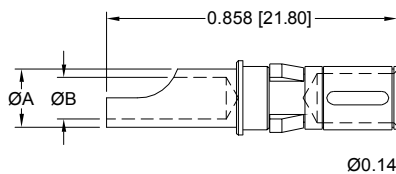

MALE CONTACT

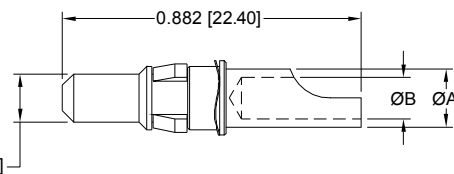

FEMALE PART NUMBER	WIRE SIZE AWG [mm ²]	Ø A	Ø B
FS4008D	8 [10.0]	0.219 [5.56]	0.188 [4.78]
FS4012D	12 [4.0]	0.143 [3.63]	0.112 [2.84]
FS4016D	16 [1.5]	0.100 [2.54]	0.069 [1.75]

MALE PART NUMBER	WIRE SIZE AWG [mm ²]	Ø A	Ø B
MS4008D	8 [10.0]	0.219 [5.56]	0.188 [4.78]
MS4012D	12 [4.0]	0.143 [3.63]	0.112 [2.84]
MS4016D	16 [1.5]	0.100 [2.54]	0.069 [1.75]

*1 NOTE: Female contacts feature Large Surface Area (L.S.A.) closed entry contact design which provides maximum mating surfaces between male and female contact and reduced contact resistance during operation.

For information regarding crimp tool and crimping tool techniques, see Application Tools section, page 82.

REMOVABLE HIGH VOLTAGE POWER CONTACT
FOR USE WITH CBD, CBC, CBCD AND CBDD SERIES CONNECTORS

SIZE 8

Note: Connectors can be kitted with all applicable removable contacts, contact Technical Sales for connector part number.

STRAIGHT SOLDER WIRE TERMINATION

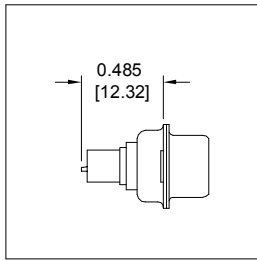

FEMALE CONTACT

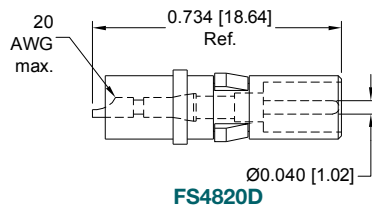

MALE CONTACT

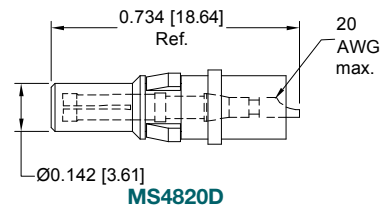

RIGHT ANGLE (90°) SOLDER WIRE TERMINATION

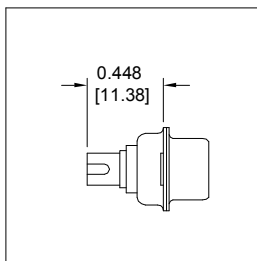

FEMALE CONTACT

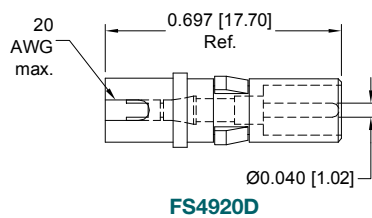

MALE CONTACT

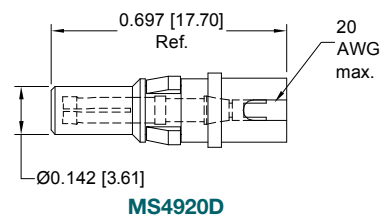

STRAIGHT PRINTED BOARD MOUNT POWER CONTACT

FOR USE WITH CBD AND CBDD SERIES CONNECTORS

SIZE 8

Positronic recommends printed circuit board termination contacts be supplied installed in the connector. Contact technical sales for part number information.

For contact current rating, see page 4.

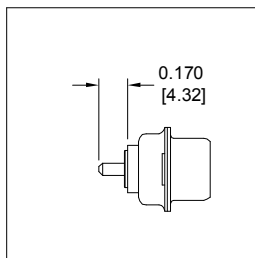

***1 FEMALE CONTACT**

"CLOSED ENTRY" DESIGN, L.S.A.

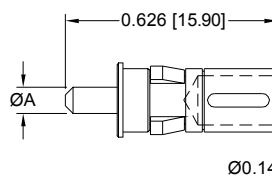

MALE CONTACT

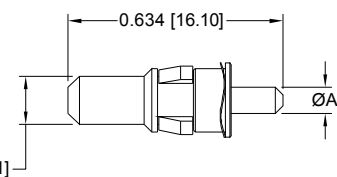

FEMALE PART NUMBER	Ø A	CONTACT CODE
FDS4314D	0.078 [1.98]	35
FDS4312D	0.094 [2.39]	36
FDS4310D	0.125 [3.18]	37

MALE PART NUMBER	Ø A	CONTACT CODE
MDS4314D	0.078 [1.98]	35
MDS4312D	0.094 [2.39]	36
MDS4310D	0.125 [3.18]	37

****NOTE:** Female contacts feature Large Surface Area (L.S.A.) closed entry contact design which provides maximum mating surfaces between male and female contact and reduced contact resistance during operation.

For information regarding crimp tool and crimping tool techniques, see Application Tools section, page 82.



RIGHT ANGLE (90°) PRINTED BOARD MOUNT POWER CONTACT FOR USE WITH CBD AND CBDD SERIES CONNECTORS

SIZE 8

Positronic recommends printed circuit board termination contacts be supplied installed in the connector. Contact technical sales for part number information.

For contact current rating, see page 4.

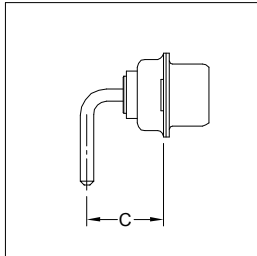

***1 FEMALE CONTACT**
"CLOSED ENTRY" DESIGN, L.S.A.

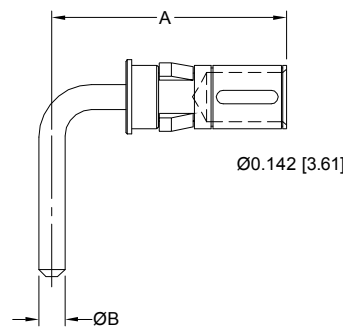

MALE CONTACT

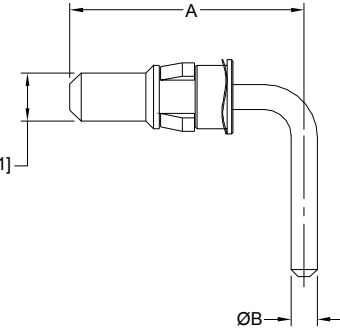

FEMALE PART NUMBER	A REF.	Ø B	C	SHELL SIZE	CONTACT CODE
FRT4314D	0.580 [14.73]	0.078 [1.98]	0.339 [8.61]	1, 2, 3 & 4	55
FRT4414D	0.692 [17.58]	0.078 [1.98]	0.451 [11.46]	5	55
FRT4714D	0.661 [16.79]	0.078 [1.98]	0.420 [10.67]	1, 2, 3 & 4	75
FRT4814D	0.773 [19.63]	0.078 [1.98]	0.520 [13.21]	5	75
FRT4310D	1.051 [26.70]	0.125 [3.18]	0.810 [20.57]	1, 2, 3 & 4	57
FRT4410D	1.051 [26.70]	0.125 [3.18]	0.810 [20.57]	5	57

MALE PART NUMBER	A REF.	Ø B	C	SHELL SIZE	CONTACT CODE
MRT4314D	0.580 [14.73]	0.078 [1.98]	0.339 [8.61]	1, 2, 3 & 4	55
MRT4414D	0.692 [17.58]	0.078 [1.98]	0.451 [11.46]	5	55
MRT4714D	0.661 [16.79]	0.078 [1.98]	0.420 [10.67]	1, 2, 3 & 4	75
MRT4814D	0.773 [19.63]	0.078 [1.98]	0.520 [13.21]	5	75
MRT4310D	1.051 [26.70]	0.125 [3.18]	0.810 [20.57]	1, 2, 3 & 4	57
MRT4410D	1.051 [26.70]	0.125 [3.18]	0.810 [20.57]	5	57

***1 NOTE:** Female contacts feature Large Surface Area (L.S.A.) closed entry contact design which provides maximum mating surfaces between male and female contact and reduced contact resistance during operation.

For information regarding crimp tool and crimping tool techniques, see Application Tools section, page 82.



REMOVABLE SHIELDED CONTACT
FOR USE WITH CBD, CBC, CBCD AND CBDD SERIES CONNECTORS
SIZE 8

Note: Connectors can be kitted with all applicable removable contacts, contact Technical Sales for connector part number.

STRAIGHT SOLDER/CRIMP CONTACTS

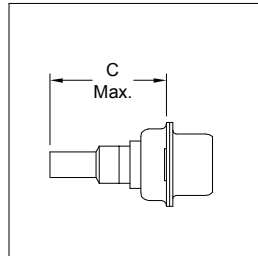

FEMALE CONTACT

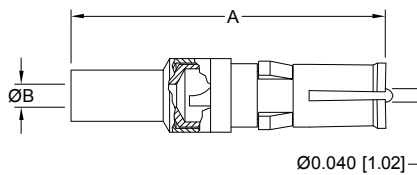

MALE CONTACT

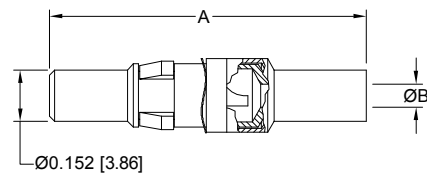

STRAIGHT SOLDER/SOLDER CONTACTS

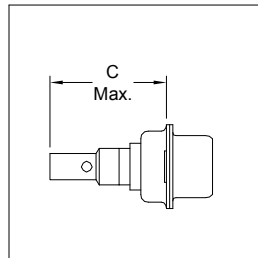

FEMALE CONTACT

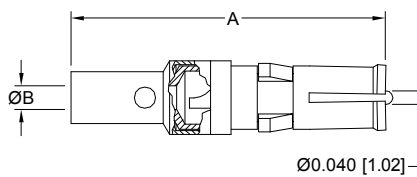

MALE CONTACT

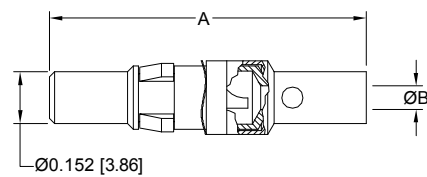

STRAIGHT CRIMP/CRIMP CONTACTS

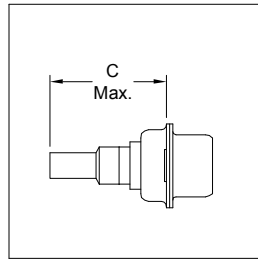

FEMALE CONTACT

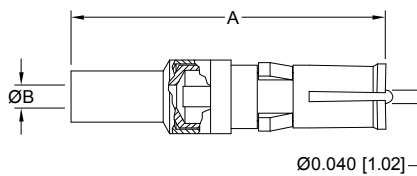

MALE CONTACT

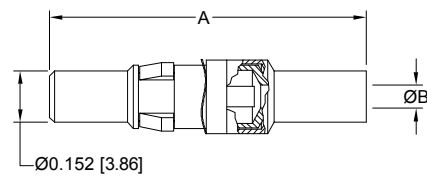

TYPE OF CONTACT	FEMALE PART NUMBER	MALE PART NUMBER	A	Ø B	C MAX.	RG CABLE NUMBER
SOLDER/CRIMP	FC4101D	MC4101D	0.929 [23.60]	0.040 [1.02]	0.739 [18.77]	178 B/U 196 B/U
SOLDER/CRIMP	FC4102D	MC4102D	0.929 [23.60]	0.067 [1.70]	0.739 [18.77]	179 B/U 316 /U
SOLDER/CRIMP	FC4103D	MC4103D	1.037 [26.34]	0.108 [2.74]	0.847 [21.51]	180 B/U
SOLDER/CRIMP	FC4104D	MC4104D	1.037 [26.34]	0.120 [3.05]	0.847 [21.51]	58 B/U
SOLDER/SOLDER	FS4101D	MS4101D	0.929 [23.60]	0.040 [1.02]	0.739 [18.77]	178 B/U 196 B/U
SOLDER/SOLDER	FS4102D	MS4102D	0.929 [23.60]	0.067 [1.70]	0.739 [18.77]	179 B/U 316 /U
SOLDER/SOLDER	FS4103D	MS4103D	1.037 [26.34]	0.108 [2.74]	0.847 [21.51]	180 B/U
SOLDER/SOLDER	FS4104D	MS4104D	1.037 [26.34]	0.120 [3.05]	0.847 [21.51]	58 B/U
CRIMP/CRIMP	FCC4101D	MCC4101D	0.929 [23.60]	0.040 [1.02]	0.739 [18.77]	178 B/U 196 B/U
CRIMP/CRIMP	FCC4102D	MCC4102D	0.929 [23.60]	0.067 [1.70]	0.739 [18.77]	179 B/U 316 /U
CRIMP/CRIMP	FCC4103D	MCC4103D	1.037 [26.34]	0.108 [2.74]	0.847 [21.51]	180 B/U
CRIMP/CRIMP	FCC4104D	MCC4104D	1.037 [26.34]	0.120 [3.05]	0.847 [21.51]	58 B/U



SHIELDED CONTACTS

Two-step crimping action for signal and shielding conductors.

For information regarding crimp tool and crimping tool techniques, see Application Tools section, page 82.



STRAIGHT PRINTED BOARD MOUNTED SHIELDED CONTACT FOR USE WITH CBD AND CBDD SERIES CONNECTORS

SIZE 8

Positronic **recommends** printed circuit board termination **contacts be supplied installed** in the connector. **Contact technical sales** for part number information.

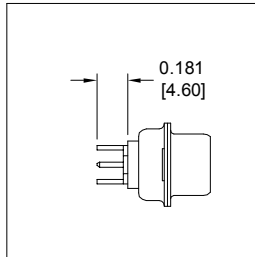

Suggest $\varnothing 0.045$
[1.14] hole

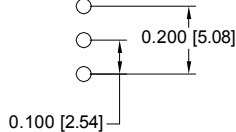

CONTACT HOLE PATTERN

FEMALE CONTACT

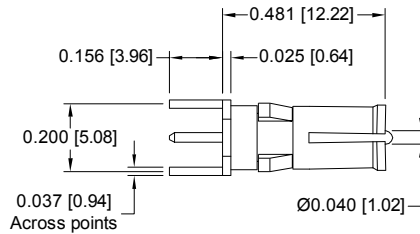

FDS4201D

MALE CONTACT

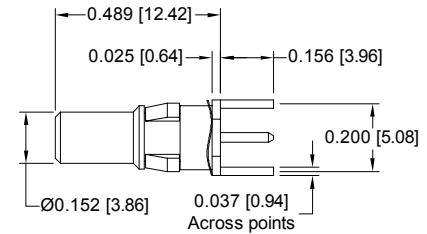

MDS4201D

RIGHT ANGLE (90°) PRINTED BOARD MOUNT SHIELDED CONTACT FOR USE WITH CBD AND CBDD SERIES CONNECTORS

SIZE 8

Positronic **recommends** printed circuit board termination **contacts be supplied installed** in the connector. **Contact technical sales** for part number information.

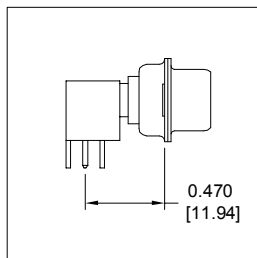

Suggest $\varnothing 0.045$
[1.14] hole

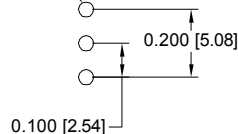

CONTACT HOLE PATTERN

FEMALE CONTACT

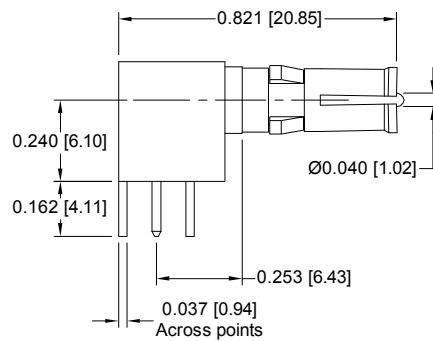

FRT4201D

MALE CONTACT

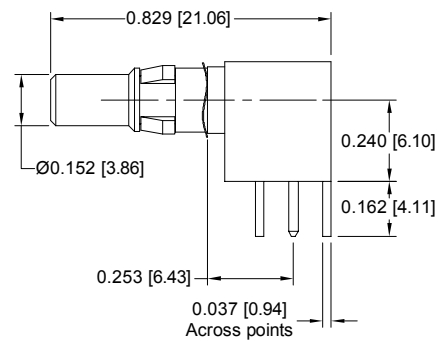

MRT4201D

For information regarding crimp tool and crimping tool techniques, see Application Tools section, page 82.

REMOVABLE AIR LINE COUPLERS

FOR USE WITH CBD, CBC, CBCD AND CBDD SERIES CONNECTORS

SIZE 8

**AIR LINE COUPLER CONTACTS
REQUIRE JACKSCREWS TO
COUPLE MATING CONNECTORS**

Note: Connectors can be kitted with all applicable removable contacts, contact Technical Sales for connector part number.

FEMALE CONTACT

MALE CONTACT

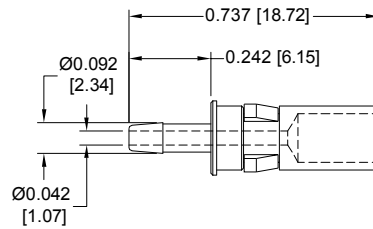
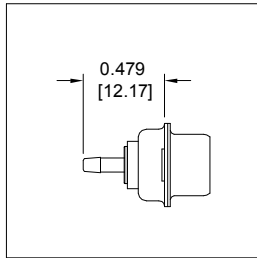

FA4063S

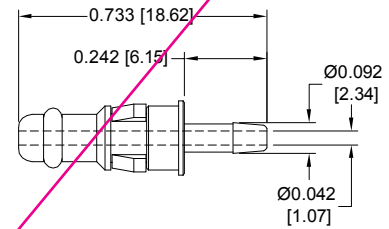

MA4063S

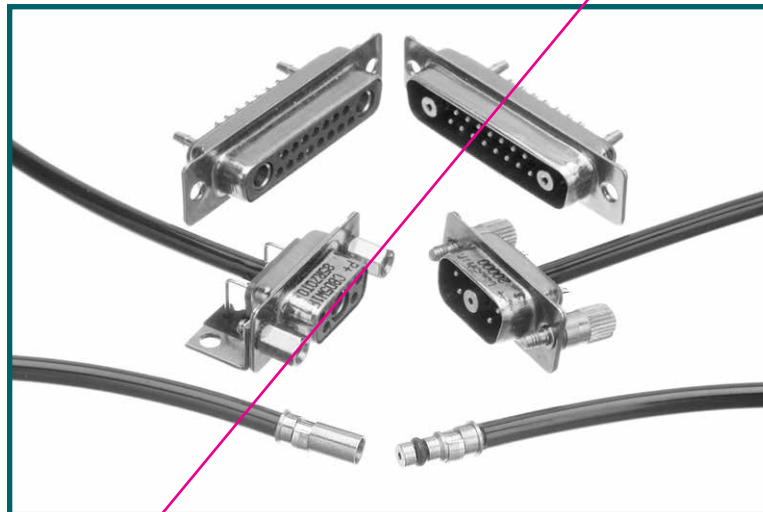

TECHNICAL CHARACTERISTICS

MATERIALS AND FINISHES:

Contacts: Stainless steel

MECHANICAL CHARACTERISTICS:

**Size 8 Removable
Contacts:** Rear insertion, front release.

CLIMATIC CHARACTERISTICS:

Temperature Range: -55°C to +125°C.

CONTACT TECHNICAL SALES FOR MORE INFORMATION!

For information regarding crimp tool and crimping tool techniques, see Application Tools section, page 82.



MODIFICATION (MOS) SUFFIXES

Specify complete connector by selecting a base part number from the desired series [Ordering Information Page](#). Once base part number is selected, add desired modifications (MOS) number below to the end of the part number.

Example part number: CBD17W2F55R7NT2X/AA-14-1062.1 *(Ordering information pages can be found at the end of each series)*

SERIES	CONNECTOR VARIANT	GENDER	TERMINATION TYPE AVAILABLE	MODIFICATIONS OF STANDARD (MOS) SUFFIXES	DESCRIPTION OF MODIFICATION
CBD	3W3	F / M	0	-1841.0	Allows for molding to have positions A1 and A3 tooled only. Position A2 not molded but numbering will remain.
CBD	5W5	F / M	0	-1841.1	Allows for molding to have positions 1, 3 and 5 tooled only. Positions 2 and 4 not molded but numbering will remain.
CBD	8W8	F / M	0	-1841.2	Allows for molding to have positions A1,A3,A5 and A7 tooled only. Positions A2,A4,A6 and A8 not molded but numbering will remain.
CBD, CBM	3W3, 8W8	M	0	-1570.4	Integral stabilizing feature used to minimize size 8 contacts from floating in the molding. Use tool number 4311-0-1-0 to remove contact if necessary.
CBC	36W4, 43W2				
CBD, CBC, CBDD, CBHD, CBCD, CBDP*, ACBDP, ACBMP	ALL	F / M	ALL	-14	Allows connector with signal contacts installed, for signal contacts only to be plated 0.000030 [0.76 μ] gold over nickel.
CBD, CBC, CBDD, CBHD, CBCD, ACBDP, ACBMP	ALL	F / M	ALL	-14-1062.1	Allows connector with signal and power contacts installed, for both signal and power contacts to be plated 0.000030 [0.76 μ] gold over nickel
CBD, CBC, CBDD, CBHD, CBCD, CBDP*, ACBDP, ACBMP	ALL	F / M	ALL	-15	Allows connector with signal contacts installed, for signal contacts only to be plated 0.000050 inch [1.27μ] gold over nickel.
CBD, CBC, CBDD, CBHD, CBCD, ACBDP, ACBMP	ALL	F / M	ALL	-15-1062.0	Allows connector with signal and power contacts installed, for both signal and power contacts to be plated 0.000050 inch [1.27μ] gold over nickel.
CBD, CBM, CBC, CBDD, CBHD, CBCD	ALL	F / M	ALL	-1062.0	Allows connector with power contacts installed, for the power contacts only to be plated 0.000050 inch [1.27μ] gold over nickel.
CBD, CBM, CBC, CBDD, CBHD, CBCD	ALL	F / M	ALL	-1062.1	Allows connector with power contacts installed, for the power contacts only to be plated 0.000030 [0.76 μ] gold over nickel.
CBD, CBM, CBC, CBDD, CBHD, CBCD	ALL	F / M	ALL	-759.0	Allows connectors to be supplied with blind mate guides, lockwashers and hexnuts installed. For connectors with a 4-40 threaded mounting style install blind mate guides only. For connectors with a R3/R6 mounting style install special blind mate guides with lockwashers and hexnuts. See D-subminiature Accessories catalog for more details.
CBD, CBM, CBC, CBDD, CBHD, CBCD	ALL	F / M	ALL	-759.1	Allows connector, with any contacts to include blind mate mounting plate. See D-subminiature Accessories catalog for more details.
QB	FOR CONTACTS	F	FC40**D CONTACTS	-1817.0	Allows for contacts to have a crimp barrel with a length of 0.310 [7.87].
QB	7W2, 9W4	M	56, 57	-1865.0	Connector with standard right angle (90°) brackets replaced with 4535-78-0 right angle (90°) brackets.
QB	7W2	M	N/A	-1845.0	Allows for a connector to be supplied with inverted bend. Contact tail length below bracket of 0.122 [3.10] max. Alignment bar not required.

MANY OTHER SPECIAL OPTIONS ARE AVAILABLE REFER TO D-SUBMINIATURE ACCESSORIES CATALOG, CONSULT TECHNICAL SALES OR VISIT OUR WEBSITE AT WWW.CONNECTPOSITRONIC.COM



APPLICATION TOOLS SECTION

CBD / CBM / CBC / CBCD / QB connectors are offered with removable crimp contacts. Positronic recognizes the importance of supplying application tooling to support our customers' use of our products.



Information on application tooling is available on our web site at



www.connectpositronic.com/design-tools/tooling

There you will find downloadable PDF cross reference charts for removable and compliant press-fit contacts. These charts will supply part numbers for insertion, removal and crimping tools, along with information regarding use of tools and techniques.



CONTACT REELS FOR AUTOMATIC PNEUMATIC CRIMP TOOLS

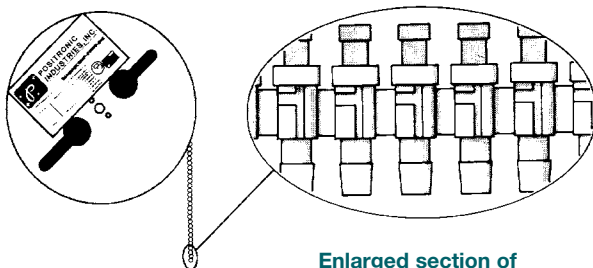

Enlarged section of plastic contact carriers

Contacts may be supplied in plastic carriers, packaged in reels holding 2,000 contacts for use with the automatic pneumatic crimp tools, catalog part number 9550-0-0-0 and 9550-1-0-0; packaged in reels holding 1,000 contacts for use with the automatic pneumatic crimp tools, catalog part number 9550-0-2-0. The same type carrier is used for both male and female contacts.

All male and female crimp contacts can be ordered in reels by adding letter "R" after the contact part number, such as MC8022DR for a male contact and FC112N4R for female contact.



CONTACT APPLICATION TOOLS CROSS REFERENCE LIST

USE INDICATED POSITRONIC TOOLS FOR BEST RESULTS

Contact Size	Positronic Contact P/N	Handle & Positioner P/N	Hand Crimp Tool P/N	Mfg. Cross	Mill Equiv	Positioner	Mfg. Cross	Mill Equiv	Insertion Tool	Mfg. Cross	Mill Equiv	Removal Tool	Mfg. Cross	Mill Equiv	Automatic Crimp Tool *1 See Note
8	FA4063S											4311-0-0-0	P+		
8	FC4008D	9504-19-0-0	9504-1-0-0	HX4	M22520/5-01	9504-19-1-0	Y524		N/A			4311-0-0-0	P+		9555-0-2-0
8	FC4008D-1817.0	9504-19-0-0	9504-1-0-0	HX4	M22520/5-01	9504-19-1-0	Y524		N/A			4311-0-0-0	P+		9555-0-2-0
8	FC4008DS	9504-19-0-0	9504-1-0-0	HX4	M22520/5-01	9504-19-1-0	Y524		N/A			4311-0-0-0	P+		9555-0-2-0
8	FC4011D	9509-0-0-0	9509-1-0-0	M310		9509-2-0-0	TP-974		N/A			4311-0-0-0	P+		9555-0-2-0
8	FC4012D-1817.0	9509-0-0-0	9509-1-0-0	M310		9509-2-0-0	TP-974		N/A			4311-0-0-0	P+		9555-0-2-0
8	FC4101D	9504-14-0-0	9504-1-0-0	HX4	M22520/5-01	9504-14-1-0	Y878		N/A			4311-0-0-0	P+		
8	FC4102D	9504-13-0-0	9504-1-0-0	HX4	M22520/5-01	9504-13-1-0	Y937		N/A			4311-0-0-0	P+		
8	FCC4103D	9504-15-0-0	9504-1-0-0	HX4	M22520/5-01	9504-15-1-0	Y877		N/A			4311-0-0-0	P+		
8	FCC4104D	9504-15-0-0	9504-1-0-0	HX4	M22520/5-01	9504-15-1-0	Y877		N/A			4311-0-0-0	P+		
8	FDS4101D											4311-0-0-0	P+		
8	FRT4201D											4311-0-0-0	P+		
8	FRT411D											4311-0-0-0	P+		
8	FS4008D											4311-0-0-0	P+		
8	FS4011D											4311-0-0-0	P+		
8	FS4101D											4311-0-0-0	P+		
8	FS420D											4311-0-0-0	P+		
8	MA4063S											4311-0-0-0	P+		
8	MC4008D	9504-19-0-0	9504-1-0-0	HX4	M22520/5-01	9504-19-1-0	Y524		N/A			4311-0-0-0	P+		9555-0-2-0
8	MC4008DS	9504-19-0-0	9504-1-0-0	HX4	M22520/5-01	9504-19-1-0	Y524		N/A			4311-0-0-0	P+		9555-0-2-0
8	MC4011D	9509-0-0-0	9509-1-0-0	M310		9509-2-0-0	TP-974		N/A			4311-0-0-0	P+		9555-0-2-0
8	MC4101D	9504-0-0-0	9504-1-0-0	HX4	M22520/5-01	9504-2-0-0	Y322		N/A			4311-0-0-0	P+		
8	MC4101D	9504-14-0-0	9504-1-0-0	HX4	M22520/5-01	9504-14-1-0	Y878		N/A			4311-0-0-0	P+		
8	MC4102D	9504-13-0-0	9504-1-0-0	HX4	M22520/5-01	9504-13-1-0	Y937		N/A			4311-0-0-0	P+		
8	MCC4103D	9504-15-0-0	9504-1-0-0	HX4	M22520/5-01	9504-15-1-0	Y877		N/A			4311-0-0-0	P+		
8	MCC4104D	9504-15-0-0	9504-1-0-0	HX4	M22520/5-01	9504-15-1-0	Y877		N/A			4311-0-0-0	P+		
8	MDS4201D											4311-0-0-0	P+		
8	MDS411D											4311-0-0-0	P+		
8	MS4008D											4311-0-0-0	P+		
8	MS4011D											4311-0-0-0	P+		
8	MS4101D											4311-0-0-0	P+		
8	MS420D											4311-0-0-0	P+		

*1 for complete listing of contact part numbers, see removable contact section pages 68-80.

*1 All male and female crimp contacts can be ordered on reels in quantities of 1,000 and 2,000 by adding letter "R" after the contact part number, see page 82 for more information.



CONTACT APPLICATION TOOLS CROSS REFERENCE LIST

USE INDICATED POSITRONIC TOOLS FOR BEST RESULTS

Contact Size	Positronic Contact P/N	Handle & Positioner P/N	Hand Crimp Tool P/N	Mfg. Cross	Mill Equiv	Positioner	Mfg. Cross	Mill Equiv	Insertion Tool	Mfg. Cross	Mill Equiv	Removal Tool	Mfg. Cross	Mill Equiv	Automatic Crimp Tool * See Note
22	FC8020D2		9507-0-0-0	AFM8	M22520/2-01	9502-29-0-0	K1665								
22	FC8022D2		9507-0-0-0	AFM8	M22520/2-01	9502-3-0-0	K-41	M22520/2-06	M81969/1-04	91067-1	M81969/1-04	M81969/1-04	91067-1	M81969/1-04	9550-1-0-0
22	FC8022D2** Thermocouple		9507-0-0-0	AFM8	M22520/2-01	9502-3-0-0	K-41	M22520/2-06	M81969/1-04	91067-1	M81969/1-04	M81969/1-04	91067-1	M81969/1-04	9550-1-0-0
22	MC8020D		9507-0-0-0	AFM8	M22520/2-01	9502-29-0-0	K1665		M81969/1-04	91067-1	M81969/1-04	M81969/1-04	91067-1	M81969/1-04	9550-1-0-0
22	MC8022D		9507-0-0-0	AFM8	M22520/2-01	9502-4-0-0	K-42	M22520/2-09	M81969/1-04	91067-1	M81969/1-04	M81969/1-04	91067-1	M81969/1-04	9550-1-0-0
22	MC8022D** Thermocouple		9507-0-0-0	AFM8	M22520/2-01	9502-4-0-0	K-42	M22520/2-09	M81969/1-04	91067-1	M81969/1-04	M81969/1-04	91067-1	M81969/1-04	9550-1-0-0
22	M39029/57-354		9507-0-0-0	AFM8	M22520/2-01	9502-3-0-0	K41	M22520/2-06	M81969/1-04	91067-1	M81969/1-04	M81969/1-04	91067-1	M81969/1-04	9550-1-0-0
22	M39029/58-360		9507-0-0-0	AFM8	M22520/2-01	9502-4-0-0	K42	M22520/2-09	M81969/1-04	91067-1	M81969/1-04	M81969/1-04	91067-1	M81969/1-04	9550-1-0-0
20	FC6018D2		9507-0-0-0	AFM8	M22520/2-01	9502-11-0-0	K774		M81969/1-02	91067-2	M81969/1-02	M81969/1-02	91067-2	M81969/1-02	9550-1-0-0
20	FC6020D2		9507-0-0-0	AFM8	M22520/2-01	9502-5-0-0	K13-1	M22520/2-08	M81969/1-02	91067-2	M81969/1-02	M81969/1-02	91067-2	M81969/1-02	9550-1-0-0
20	FC6020D2** Thermocouple		9507-0-0-0	AFM8	M22520/2-01	9502-5-0-0	K13-1	M22520/2-08	M81969/1-02	91067-2	M81969/1-02	M81969/1-02	91067-2	M81969/1-02	9550-1-0-0
20	FC6026D2		9507-0-0-0	AFM8	M22520/2-01	9502-5-0-0	K13-1	M22520/2-08	M81969/1-02	91067-2	M81969/1-02	M81969/1-02	91067-2	M81969/1-02	9550-1-0-0
20	FC6026D2** Thermocouple		9507-0-0-0	AFM8	M22520/2-01	9502-5-0-0	K13-1	M22520/2-08	M81969/1-02	91067-2	M81969/1-02	M81969/1-02	91067-2	M81969/1-02	9550-1-0-0
20	FC6520D		9507-0-0-0	AFM8	M22520/2-01	9502-5-0-0	K13-1	M22520/2-08	M81969/1-02	91067-2	M81969/1-02	M81969/1-02	91067-2	M81969/1-02	9550-1-0-0
20	M39029/6*-36*		9507-0-0-0	AFM8	M22520/2-01	9502-5-0-0	K13-1	M22520/2-08	M81969/1-02	91067-2	M81969/1-02	M81969/1-02	91067-2	M81969/1-02	9550-1-0-0
20	MC6018D		9507-0-0-0	AFM8	M22520/2-01	9502-11-0-0	K774		M81969/1-02	91067-2	M81969/1-02	M81969/1-02	91067-2	M81969/1-02	9550-1-0-0
20	MC6020D		9507-0-0-0	AFM8	M22520/2-01	9502-5-0-0	K13-1	M22520/2-08	M81969/1-02	91067-2	M81969/1-02	M81969/1-02	91067-2	M81969/1-02	9550-1-0-0
20	MC6020D Thermocouple		9507-0-0-0	AFM8	M22520/2-01	9502-5-0-0	K13-1	M22520/2-08	M81969/1-02	91067-2	M81969/1-02	M81969/1-02	91067-2	M81969/1-02	9550-1-0-0
20	MC6026D		9507-0-0-0	AFM8	M22520/2-01	9502-5-0-0	K13-1	M22520/2-08	M81969/1-02	91067-2	M81969/1-02	M81969/1-02	91067-2	M81969/1-02	9550-1-0-0
20	MC6026D** Thermocouple		9507-0-0-0	AFM8	M22520/2-01	9502-5-0-0	K13-1	M22520/2-08	M81969/1-02	91067-2	M81969/1-02	M81969/1-02	91067-2	M81969/1-02	9550-1-0-0
16	FC11*N4		9501-0-0-0	AF8	M22520/1-01	T.B.D.	T.B.D.		M81969/18-01	9081-0-0-0	M81969/18-01	M81969/18-01	9081-0-0-0	M81969/18-01	9550-0-0-0
16	FC112N4S		9509-4-0-0	GS222		9509-5-0-0	TP366		M81969/18-01	9081-0-0-0	M81969/18-01	M81969/18-01	9081-0-0-0	M81969/18-01	9550-0-0-0
16	FC120N4		9501-0-0-0	AF8	M22520/1-01	T.B.D.	T.B.D.		M81969/18-01	9081-0-0-0	M81969/18-01	M81969/18-01	9081-0-0-0	M81969/18-01	9550-0-0-0
16	MC11*N-133.0		9501-0-0-0	AF8	M22520/1-01	9502-17-0-0	TP1110		M81969/18-01	9081-0-0-0	M81969/18-01	M81969/18-01	9081-0-0-0	M81969/18-01	9550-0-0-0
16	MC112NS-133.0		9509-4-0-0	GS222		9509-5-0-0	TP1366		M81969/18-01	9081-0-0-0	M81969/18-01	M81969/18-01	9081-0-0-0	M81969/18-01	9550-0-0-0
16	MC120N-133.0		9501-0-0-0	AF8	M22520/1-01	9502-17-0-0	TP1110		M81969/18-01	9081-0-0-0	M81969/18-01	M81969/18-01	9081-0-0-0	M81969/18-01	9550-0-0-0

STOOL NOTIFICATION APPLICATION

* For complete listing of contact part numbers, see removable contact section pages 68-80.

*1 All male and female crimp contacts can be ordered on reels in quantities of 1,000 and 2,000 by adding letter "R" after the contact part number, see page 82 for more information.



SUGGESTED PRINTED BOARD HOLE SIZES FOR COMPLIANT PRESS-FIT CONNECTORS

Traditionally, tin-lead has been a popular plating for printed circuit board (PCB) holes. However, many PCB hole platings must now be RoHS Compliant. Positronic is pleased to offer **PCB HOLE SIZE FOR RoHS** PCB plating as shown below.

APPLICATION TOOLS

OMEGA & BI-SPRING COMPLIANT PRESS-FIT CONTACT HOLE				
BOARD TYPE	CONTACT SIZE / TYPE	RECOMMENDED DRILL HOLE SIZE	RECOMMENDED PLATING	FINISHED HOLE SIZES
TIN-LEAD SOLDER PCB	22 OMEGA	$\phi 0.0453 \pm 0.0010$ [$\phi 1.150 \pm 0.025$]	0.0006 [15 μ] minimum solder over 0.0010 [25 μ] min. copper	$\phi 0.0394 + 0.0035 - 0.0024$ [$\phi 1.000 + 0.090 - 0.060$]
	20 OMEGA	$\phi 0.0453 \pm 0.0010$ [$\phi 1.150 \pm 0.025$]		$\phi 0.0394 + 0.0035 - 0.0024$ [$\phi 1.000 + 0.090 - 0.060$]
	16 BI-SPRING	$\phi 0.069 \pm 0.001$ [$\phi 1.750 \pm 0.025$]		$\phi 0.0630 + 0.0035 - 0.0024$ [$\phi 1.600 + 0.090 - 0.060$]
	8 BI-SPRING	$\phi 0.125 \pm 0.001$ [$\phi 3.180 \pm 0.025$]		$\phi 0.119 \pm 0.002$ [$\phi 3.02 \pm 0.05$]
RoHS PCB PLATING OPTIONS				
COPPER PCB	22 OMEGA	$\phi 0.047 \pm 0.001$ [$\phi 1.19 \pm 0.025$]	0.0010 [25 μ] min. copper	$\phi 0.043 \pm 0.002$ [$\phi 1.09 \pm 0.05$]
	20 OMEGA	$\phi 0.047 \pm 0.001$ [$\phi 1.19 \pm 0.025$]		$\phi 0.043 \pm 0.002$ [$\phi 1.09 \pm 0.05$]
	16 BI-SPRING	$\phi 0.069 \pm 0.001$ [$\phi 1.750 \pm 0.025$]		$\phi 0.0630 + 0.0035 - 0.0024$ [$\phi 1.600 + 0.090 - 0.060$]
	8 BI-SPRING	$\phi 0.125 \pm 0.001$ [$\phi 3.180 \pm 0.025$]		$\phi 0.119 \pm 0.002$ [$\phi 3.02 \pm 0.05$]
IMMERSION TIN PCB	22 OMEGA	$\phi 0.047 \pm 0.001$ [$\phi 1.19 \pm 0.025$]	0.000033 \pm 0.000006 [0.85 \pm 0.15 μ] immersion tin over 0.0010 [25 μ] min. copper	$\phi 0.043 \pm 0.002$ [$\phi 1.09 \pm 0.05$]
	20 OMEGA	$\phi 0.047 \pm 0.001$ [$\phi 1.19 \pm 0.025$]		$\phi 0.043 \pm 0.002$ [$\phi 1.09 \pm 0.05$]
	16 BI-SPRING	$\phi 0.069 \pm 0.001$ [$\phi 1.750 \pm 0.025$]		$\phi 0.0630 + 0.0035 - 0.0024$ [$\phi 1.600 + 0.090 - 0.060$]
	8 BI-SPRING	$\phi 0.125 \pm 0.001$ [$\phi 3.180 \pm 0.025$]		$\phi 0.119 \pm 0.002$ [$\phi 3.02 \pm 0.05$]
IMMERSION SILVER PCB	22 OMEGA	$\phi 0.047 \pm 0.001$ [$\phi 1.19 \pm 0.025$]	0.000013 \pm 0.000007 [0.34 \pm 0.17 μ] immersion silver over 0.0010 [25 μ] min. copper	$\phi 0.043 \pm 0.002$ [$\phi 1.09 \pm 0.05$]
	20 OMEGA	$\phi 0.047 \pm 0.001$ [$\phi 1.19 \pm 0.025$]		$\phi 0.043 \pm 0.002$ [$\phi 1.09 \pm 0.05$]
	16 BI-SPRING	$\phi 0.069 \pm 0.001$ [$\phi 1.750 \pm 0.025$]		$\phi 0.0630 + 0.0035 - 0.0024$ [$\phi 1.600 + 0.090 - 0.060$]
	8 BI-SPRING	$\phi 0.125 \pm 0.001$ [$\phi 3.180 \pm 0.025$]		$\phi 0.119 \pm 0.002$ [$\phi 3.02 \pm 0.05$]
ELECTROLESS NICKEL / IMMERSION GOLD PCB	22 OMEGA	$\phi 0.047 \pm 0.001$ [$\phi 1.19 \pm 0.025$]	0.000002 [0.05 μ] min. immersion gold over 0.000177 \pm 0.000059 [4.5 \pm 1.5 μ] electroless nickel per IPC-4552 over 0.0010 [25 μ] min. copper	$\phi 0.043 \pm 0.002$ [$\phi 1.09 \pm 0.05$]
	20 OMEGA	$\phi 0.047 \pm 0.001$ [$\phi 1.19 \pm 0.025$]		$\phi 0.043 \pm 0.002$ [$\phi 1.09 \pm 0.05$]
	16 BI-SPRING	$\phi 0.069 \pm 0.001$ [$\phi 1.750 \pm 0.025$]		$\phi 0.0630 + 0.0035 - 0.0024$ [$\phi 1.600 + 0.090 - 0.060$]
	8 BI-SPRING	$\phi 0.125 \pm 0.001$ [$\phi 3.180 \pm 0.025$]		$\phi 0.119 \pm 0.002$ [$\phi 3.02 \pm 0.05$]

“Omega” Termination
utilized on signal contacts



“Bi-Spring” Termination
utilized on signal contacts

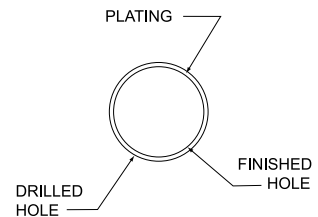

COMPLIANT PRESS-FIT TERMINATION CONTACT HOLE

NOTE: For PCB plating compositions not shown, consult Technical Sales.

COMPLIANT PRESS-FIT USER INFORMATION

When properly used, Positronic Industries Bi-Spring Power or Omega Signal Press-Fit terminations provide reliable service even under severe conditions.

Connectors utilizing this leading technology press-fit contact are easy to install:

1. Inexpensive installation tooling is available from Positronic, to choose the proper installation tool refer to page 86 for part number ordering information.
2. Insert the connector into the P.C. board or backplane and seat connector fully.
3. Secure the connector to the P.C. board or backplane using two self-tapping screws. The screws should be 4-40 threads supplied by customer.



COMPLIANT PRESS-FIT CONNECTOR INSTALLATION TOOLS

USE INDICATED POSITRONIC TOOLS FOR BEST RESULTS

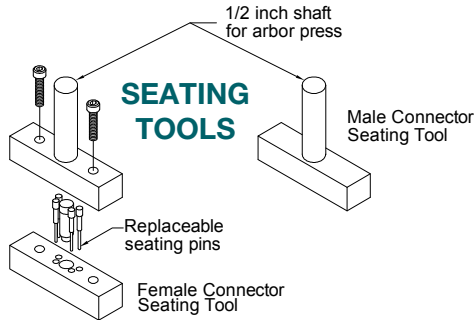

Positronic offers expert assistance in adapting application tooling to your manufacturing environment. Contact our application tooling specialist for assistance.

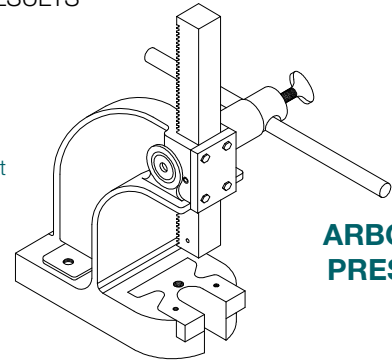

ARBOR PRESS

APPLICATION TOOLS

POSITRONIC RECOMMENDED TOOLS FOR COMPLIANT PRESS-FIT CONNECTORS AND CONTACTS

SHELL SIZE	CONNECTOR VARIANT	CONNECTOR SEATING TOOL WITH ARBOR PRESS SHAFT		ARBOR PRESS FOR SEATING TOOLS	REPLACEMENT PINS FOR CONNECTOR SEATING TOOL
		FEMALE P / N	MALE P / N		
1	2WK2	9512-44-0-41	9512-44-0-41	Use p / n 9530-1-0 1 ton capacity 4 inch throat	For 8W2 Size 22 Female contacts use pin p / n 855-751-0-41
	5W1	9512-18-0-41	9512-1-0-41		
	8W2	9512-41-0-41	9512-40-0-41		
2	3W3	9512-19-0-41	9512-2-0-41		For 19W1 Size 22 Female contacts use pin p / n 855-347-29-41
	3WK3	9512-39-0-41	9512-38-0-41		
	7W2	9512-20-0-41	9512-2-0-41		
	11W1	9512-21-0-41	9512-2-0-41		
	19W1	9512-42-0-41	9512-2-0-41		
3	5W5	9512-22-0-41	9512-3-0-41		For Size 20 Female contacts use pin p / n 855-347-18-41
	9W4	9512-23-0-41	9512-3-0-41		
	13W3	9512-24-0-41	9512-3-0-41		
	17W2	9512-25-0-41	9512-3-0-41		
	21W1	9512-26-0-41	9512-3-0-41		
4	8W8	9512-27-0-41	9512-4-0-41		For Size 16 Female contacts use pin p / n 855-347-28-41
	13W6	9512-28-0-41	9512-4-0-41		
	17W5	9512-29-0-41	9512-4-0-41		
	21WA4	9512-30-0-41	9512-4-0-41		
	25W3	9512-31-0-41	9512-4-0-41		
	27W2	9512-32-0-41	9512-4-0-41		
5	24W7	9512-33-0-41	9512-5-0-41	For Size 8 Female contacts use pin p / n 855-347-19-41	
	36W4	9512-34-0-41	9512-5-0-41		
	43W2	9512-35-0-41	9512-5-0-41		
	47W1	9512-36-0-41	9512-5-0-41		
6	46W4	9512-37-0-41	9512-16-0-41		Male contacts don't use replaceable pins



Positronic® offers a variety of QPL connector products

D-SUBMINIATURE CONNECTORS

MIL PREFIX	POSITRONIC SERIES
MIL-DTL-24308/1	HDC
MIL-DTL-24308/2	RD, DD
MIL-DTL-24308/3	HDC
MIL-DTL-24308/4	RD, DD
MIL-DTL-24308/5	HDC
MIL-DTL-24308/6	RD, DD
MIL-DTL-24308/7	HDC
MIL-DTL-24308/8	RD, DD
MIL-DTL-24308/23	HDC, DD

MIL PREFIX	POSITRONIC SERIES
MIL-DTL-24308/24	HDC, DD
MIL-DTL-24308/25	HDC, RD, DD
MIL-DTL-24308/26	HDC, RD, DD
GSFC S-311-P4	SND, SDD, SCBC, SCBM
GSFC S-311-P10	SND, SCBM
SAE AS39029/57	DD
SAE AS39029/58	DD
SAE AS39029/63	RD
SAE AS39029/64	RD

RECTANGULAR CONNECTORS

MIL PREFIX	POSITRONIC SERIES
MIL-DTL-28748/3	GMCT
MIL-DTL-28748/4	GMCT
MIL-DTL-28748/5	GM
MIL-DTL-28748/6	GM
MIL-DTL-28748/7	SGM

MIL PREFIX	POSITRONIC SERIES
MIL-DTL-28748/8	SGM
MIL-C-28748/13	SGMC
MIL-C-28748/14	SGMC
SAE AS39029/34	SGMC, GMCT
SAE AS39029/35	SGMC, GMCT

For a complete QPL listing available to download in PDF format, visit the desired connector family home page and click on link "Qualified Product Listing (PDF)" on our website at:

www.connectpositronic.com

or enter the URL link below to download the QPL PDF file immediately!

www.connectpositronic.com/qpl/catalog

Connector Excellence[®]

Positronic HIGH RELIABILITY Products

POWER



FEATURES:

- High current density
- Energy saving - low contact resistance
- AC/DC operation in a single connector
- Signal contacts for hardware management
- Blind mating
- Sequential mating
- Large surface area contact mating system
- Wide variety of accessories
- Customer-specified contact arrangements
- Modular tooling which produces a single piece connector insert

Contact Sizes: 0, 8, 12, 16, 20, 22 and 24
Current Ratings: To 200 amperes per contact
Terminations: Crimp and fixed cable connector, straight solder, right angle (90°) solder, straight compliant press-in and right angle (90°) compliant press-in
Configurations: Multiple variants in a variety of package sizes
Compliance: PICMG 2.11, PICMG 3.0, VITA 41, DSCC, GSFC S-311-P-4, GSFC S-311-P-10

D - SUB MINIATURE



FEATURES:

- Four performance levels available for best cost/performance ratio: professional, industrial, military and space-flight quality
- Options include high voltage, coax, thermocouple and air coupling contacts; environmentally sealed and dual port connector packages including mixed density
- Broad selection of accessories
- Size 20 and 22 contacts suitable for use in carrying power
- IP65, IP67

Contact Sizes: 8, 16, 20 and 22
Current Ratings: To 100 amperes
Terminations: Crimp, wire solder, straight solder, right angle (90°) compliant press-in and right angle (90°) compliant press-in housing sizes
Configurations: Multiple variants in both standard and high densities, seven connector housing sizes
Qualifications: MIL-DTL-24308, GSFC S-311-P-4, GSFC S-311-P-10, AS39029, DSCC

RECTANGULAR



FEATURES:

- Two performance levels available: industrial quality and military quality
- A wide variety of accessories
- Broad selection of contact arrangement and package sizes
- Connector coding device (keying) options

Contact Sizes: 16, 20 and 22
Current Ratings: To 13 amperes nominal
Terminations: Crimp, wire solder, straight solder, right angle (90°) solder, and straight compliant press-in
Configurations: Multiple variants in both standard and high densities, thirty package sizes
Qualifications: MIL-DTL-28748, AS39029, CCITT V.35

CIRCULAR



FEATURES:

- Non-corrodible / lightweight composite construction
- EMI/RFI shielded versions
- Thermocouple contacts
- Environmentally sealed versions
- Rear insertion/ front release of removable contacts
- Two level sequential mating
- Overmolding available on full assemblies

Contact Sizes: 12, 16, 20 and 22
Current Ratings: To 25 amperes nominal
Terminations: Crimp, wire solder, straight solder, and right angle (90°) solder
Configurations: Multiple variants in four package sizes
Qualifications: Environmental protection to IP67

CABLE



FEATURES:

- Shorten the supply chain and reduce additional costs and delays by "cabling" your Positronic connector selection
- Overmolding available
- Shielded and environmentally sealed versions available
- Power cables and access boxes which meet the SAE J2496 specification

- ✓ Design assemblies in accordance with customer specifications.
- ✓ Prepare wire harness connector configuration and performance specifications.
- ✓ Design each system in accordance with applicable customer, domestic, and international standards.
- ✓ Define and conduct performance and verification testing.

HERMETIC



FEATURES:

- Intended for use as an electrical feedthrough in high vacuum applications
- Helium leakage rate at ambient temperature: $< 5 \times 10^{-9}$ mbar.l/s under a vacuum 1.5×10^{-2} mbar
- Signal, power, coax and high voltage versions available
- Connectors can be mounted on flange assembly per customer specification

Contact Sizes: 8, 12, 16, 20 and 22
Current Ratings: To 40 amperes nominal
Terminations: Feedthrough is standard; flying leads and board mount available upon request
Configurations: See D-subminiature and circular configurations above
Compliance: Space-D32

For more information, visit www.connectpositronic.com or call your nearest Positronic sales office listed on the back of this catalog.



Positronic®

an Amphenol company

Divisional Headquarters

Positronic | Americas

423 N Campbell Ave
Springfield MO 65806 USA

+1 800 641 4054
info@connectpositronic.com

Positronic | Europe

Z.I. d'Engachies
46, route d'Engachies
F-32020 Auch Cedex 9 France

+33 5 6263 4491
contact@connectpositronic.com

Positronic | Asia

3014A Ubi Rd 1 #07-01
Singapore 408703

+65 6842 1419
singapore@connectpositronic.com

Sales Offices

Positronic has local sales representation all over the world. To find the nearest sales office, please visit www.connectpositronic.com/sales

LOCAL REPRESENTATIONS

www.connectpositronic.com

X-ON Electronics

Largest Supplier of Electrical and Electronic Components

Click to view similar products for D-Sub Mixed Contact Connectors category:

Click to view products by Positronic manufacturer:

Other Similar products are found below :

[790-025SF-5P5NMN](#) [790-025SJ-7P7NML](#) [121551-0569](#) [DAM-7W2PC](#) [L717TWB5W5P3R](#) [L717TWB5W5PRM84](#) [L717TWP3W3P](#) [280-058P4-13W6MTNG](#) [LCC17A3W3PEAN1](#) [3007W2PCR48E20X](#) [3008W8SXX42A10X](#) [3013W3SCM99A10X](#) [3017W2SCT56N40X](#) [3036W4PCM41A10X](#) [3036W4SCM99A10X](#) [3047W1PCM99A10X](#) [212522-7](#) [3003W3PXX43A10X](#) [3003W3PXX58N40X](#) [3007W2PAR71E20X](#) [3013W3PCM99A10X](#) [302W2CPXX56N40X](#) [3036W4SCM41A30X](#) [321WA4PCM99A10X](#) [321WA4SCT56N40X](#) [L717TWA7W2PP2SY3R](#) [DAM3WK3PNM](#) [DAM7V2PNK87](#) [DBM-17W2S-1A8N-A190-A197-1](#) [DBM21W1P](#) [5F5SSC28S41A30X](#) [790-061SH-36W2NMNA](#) [790-025SH-36W2NMT](#) [790-023PH-36W2MBY](#) [790-021SH-10P4EM](#) [DAME-3WK3S-A197](#) [DAM3WK3PA101](#) [DAA11W1SA197F0](#) [790-016PE-7P3MY](#) [790-024PK-9P9ML](#) [790-063PH-36W2MNA](#) [DAM3WK3S](#) [DAM3W3PNM](#) [L77SDAH15SOL2RM5S12](#) [DBMM5W5P-K87](#) [DBM-9W4P-K127](#) [15-005553](#) [303W3CSXX56N40X](#) [1731070470](#) [DCMMY17W5SC](#)