

POWER CONNECTION SYSTEMS

Power Connectors



Positronic[®]

THE SCIENCE OF CERTAINTY

**VERSATILE, HIGH-CURRENT,
MIXED DENSITY**

Catalog C-014 Rev. G2

www.connectpositronic.com

Connector Excellence[®]

Positronic Provides Complete Capability

Mission Statement

"To utilize product flexibility and application assistance to present quality interconnect solutions which represent value to customers worldwide."

Experience

- Founded in **1966**
- **Involvement** in the development of international connector specifications through EIA[®], IEC and ISO as well as PICMG[®].
- Introduction of new and **unique connector products** to the electronics industry.
- Patent holder for many **unique connector features and manufacturing techniques**.
- **Vertically integrated** manufacturing – raw materials to finished connectors.

Technology

- **Expertise** with solid machined contacts provides a variety of high reliability connectors including high current density power connectors.
- Quality Assurance lab is **capable of testing** to IEC, EIA, UL, CUL, military and customer-specified requirements.
- **In-house design and development** of connectors based on market need or individual customer requirements.
- **Internal manufacturing capabilities** include automatic precision contact machining, injection molding, stamping, plating operations and connector assembly.
- **Manufacturing locations** in southwest Missouri, U.S.A. (headquarters); Puerto Rico, France, China, Singapore, and India. Total square footage: 407,441.

Support

- **Quality Systems:** Select locations qualified to ISO 9001, ISO 14001, AS9100, MIL-STD-790 and customer "dock to stock" programs. Applicable products qualified to MIL-DTL-24308, AS39029, DSCC 85039, MIL-DTL-28748, Space D32, GSFC S-311-P-4 and GSFC S-311-P-10.
- Compliance to a variety of international and customer specific **environmental requirements**.
- Large **in-house inventory** of finished connectors. Customer specific **stocking programs**.
- Factory direct **technical sales support** in major cities worldwide.
- **One-on-one customer support** from worldwide factory locations.
- World class **web site**.
- **Value-added solutions** and willingness to **develop custom products** with reasonable price and delivery.



Regional Headquarters

Springfield, MO



Auch, France



Singapore



Products described within this catalog may be protected by one or more of the following US patents:

#4,900,261[†] #5,255,580 #5,329,697 #6,260,268
#6,835,079 #7,115,002 #8,944,697 #9,304,263

[†]Patented in Canada, 1992 Other Patents Pending

Positronic Industries' **FEDERAL SUPPLY CODE** (Cage Code)
FOR MANUFACTURERS is **28198**

Unless otherwise specified, **dimensional tolerances** are:

- 1) ± 0.001 inches [0.03 mm] for male contact mating diameters.
- 2) ± 0.003 inches [0.08 mm] for contact termination diameters.
- 3) ± 0.005 inches [0.13 mm] for all other diameters.
- 4) ± 0.015 inches [0.38 mm] for all other dimensions.

POSITRONIC[®] IS AN ITAR REGISTERED COMPANY

Information in this catalog is proprietary to Positronic and its subsidiaries. Positronic believes the data contained herein to be reliable. Since the technical information is given free of charge, the user employs such information at his own discretion and risk. Positronic Industries assumes no responsibility for results obtained or damages incurred from use of such information in whole or in part.

The following trademarks are owned by Positronic Industries, Inc.: Positronic Industries, Inc.[®], Positronic[®], Connector Excellence[®], P+ logo[®], PosiBand[®], PosiShop[®], Optik-D[™], and The Science of Certainty[®]. The color blue as it appears on various connectors is a trademark of Positronic Industries, Inc., Registered in U.S. Patent and Trademark Office.

Proven Performance

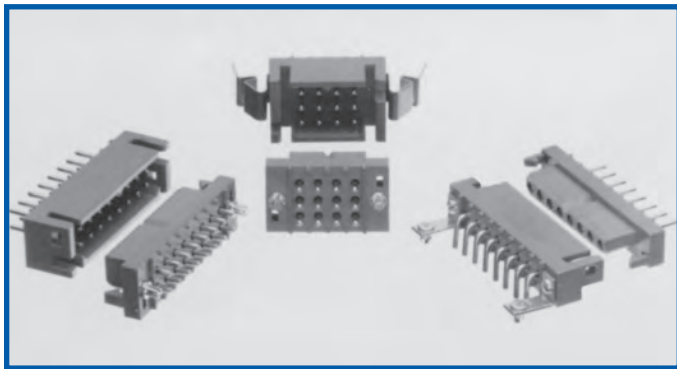
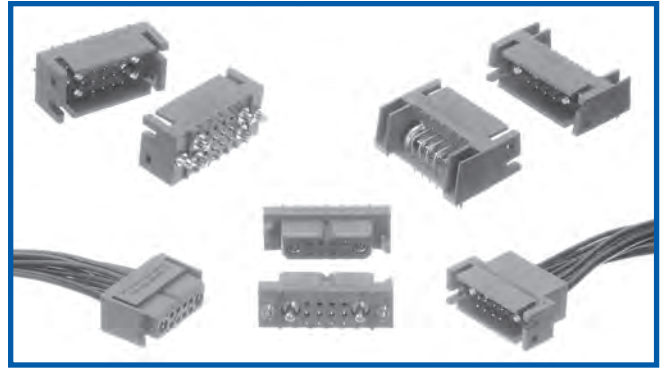
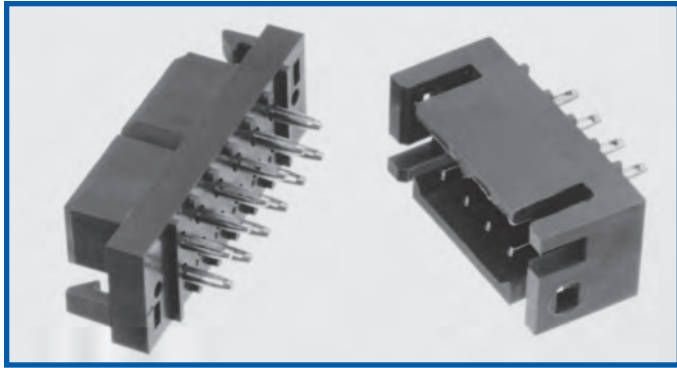

In 1989, Positronic Introduced the Power Connection Systems series. Since that time PCS has been the power connector of choice in a wide variety of applications. The popularity of PCS is due to a growing list of features, they include:

****Low Contact Resistance****

****Sequential Mating Options****

****Discriminating Locking System****

****Board to Board / Board - Cable / Cable - Cable****

****Size 12 Contacts with Screw Terminations****

****Safety Shrouded Options****

****Many Connector Variants Available From Stock****

****Mixed Density Variants****

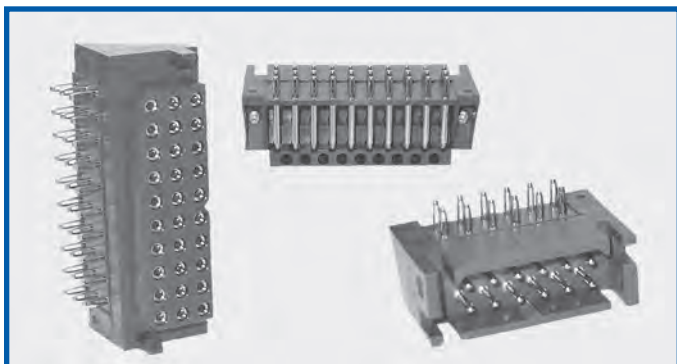
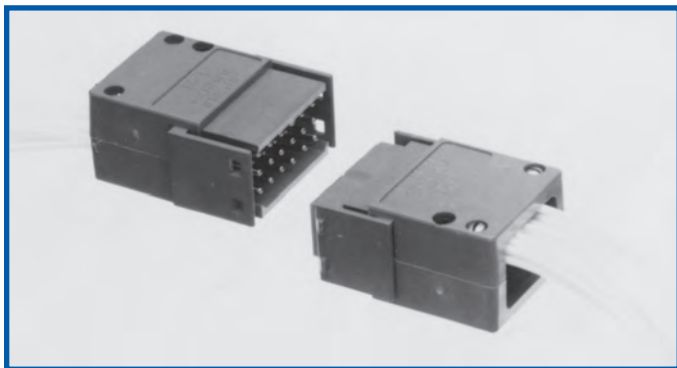



Positronic
connectpositronic.com

TABLE OF CONTENTS

Power
Connection
Systems

GENERAL INFORMATION

GENERAL INFORMATION

Typical Connection Systems	iv-3
Demystifying Current Ratings	4
Large Surface Area Contact Mating System	5
Compliant Terminations	6

PCS SERIES

PCS SERIES

Customer Specified Arrangements	7
Technical Information	8
Temperature Rise Curves	9
Mating Dimensions	10
Straight Solder Printed Board Connectors	11-12
Compliant Press-in Power Connectors	13
Straight Solder And Compliant Contact Hole Pattern	14-15
Right Angle (90°) Solder Printed Board Connectors	16-17
Right Angle (90°) Press-in Connectors	18
Right Angle (90°) Printed Board Contact Hole Pattern	19-20
Panel Mount Connectors with Solder Cup Contacts	20
Cable Connectors with Removable Contacts	21-22
Panel Mount Connectors with Removable Contacts	23-24
Sequential Mating System	25
Ordering Information	26

SAFETY SHROUD

SAFETY SHROUD SERIES

Technical Information	27
Connector Systems and Cable Connector	28
Panel Mount Connector	29
Straight Solder and Right Angle (90°) Solder Printed Board Mount Connector	30
Ordering Information	31

POWER INPUT

POWER INPUT SERIES

Technical Information	32
Connection Systems and Temperature Rises Curves	33
Cable and Panel Mount Connector	34
Straight Solder Printed Board Mount, Compliant Press-in Connector, and Contact Hole Pattern	35
Right Angle (90°) Printed Board Mount Connector and Contact Hole Pattern	36
Screw Termination and Sequential Mating Contacts	37
Ordering Information	38

P C S M I X E D D E N S I T Y S E R I E S

Technical Information.....	39-40
Temperature Rises Curves.....	40
Cable Connector.....	41
Panel Mount Connector.....	42
Straight Printed Board Mount Connector and Contact Hole Pattern.....	43
Right Angle (90°) Printed Board Mount Connector and Contact Hole Pattern.....	44
Compliant Press-in Connector.....	45
Ordering Information.....	46

R E M O V A B L E C O N T A C T

Removable Contact Technical Information.....	47
Removable Contact Technical Information and Removable Crimp Signal Contact Size 20.....	48
Removable Crimp Contact and Solder Cup Contact Size 16.....	49
Removable Shielded Contact Size 16 and Removable Crimp Contact Size 12.....	50
Removable Solder Cup Contact Size 12 and Removable Crimp Contact Size 8.....	51
Removable Solder Cup and Removable High Voltage Contact Size 8.....	52
Removable Shielded Contact Size 8.....	53

A P P L I C A T I O N T O O L S

Introduction.....	54
Contact Application Tools Cross Reference List.....	55
Press-in User Information and Connector Installation Tooling.....	56
Compliant Press-in Connectors Printed Board Hole Sizes.....	57

A C C E S S O R I E S

Right Angle (90°) Metal and Plastic Mounting Brackets.....	58
Push-on Fasteners and Mounting Screws.....	59
Connector Hoods.....	60
Quick Release Mounting Clip and Panel Cutout.....	61
Fixed Style Mounting Clip and Panel Cutout.....	62
Panel Mount Cutout.....	63
Blind Mating System and Panel Cutout.....	64

*Visit our website for the latest catalog updates and supplements at
<https://www.connectpositronic.com/family/power-connection-system/>*



Positronic
connectpositronic.com

PRINTED BOARD TO PRINTED BOARD CONNECTION SYSTEMS

Power
Connection
Systems

SYSTEM 1 MOTHER BOARD- DAUGHTER BOARD

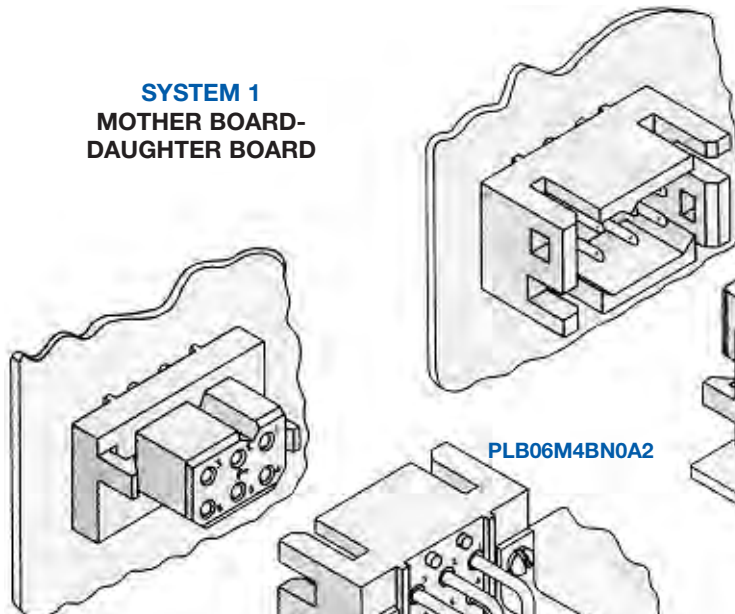

PLB06M300A1 Straight solder or
PLB06M92ST20A1 Compliant
termination press-in

PLB06F4BN0A1

PLB06M4BN0A2

SYSTEM 2 SIDE TO SIDE BOARD MOUNTING

PLB06F300A1 Straight
solder or
PLB06F94ST40A1
Compliant termination
press-in

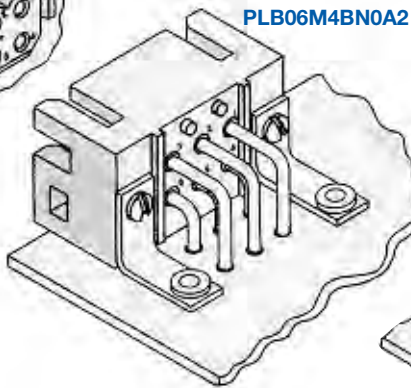

PLB06F4BN0C1

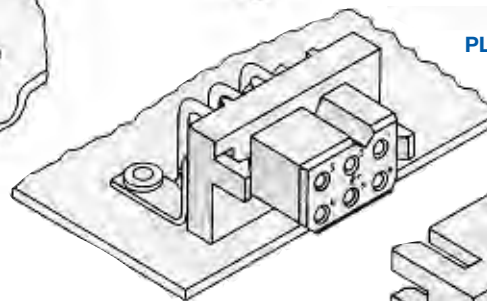

PLB06M4BN0C1

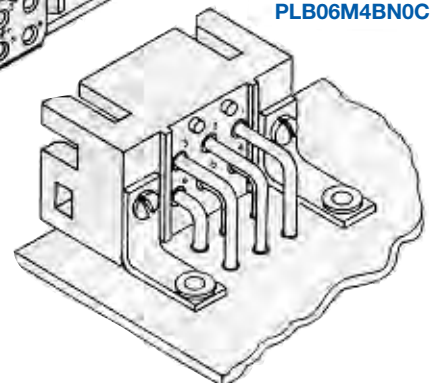

SYSTEM 3 STACKABLE BOARD MOUNTING

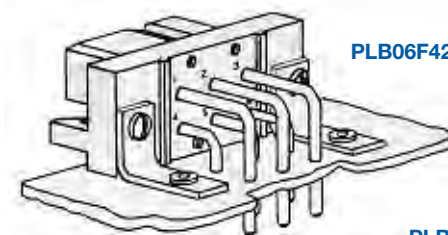

PLB06F42BN0C1

SYSTEM 4 SANDWICH BOARD MOUNTING

PLB06F32N0C1



PLB06M300A1 Straight
solder or PLB06M93ST30A1
Compliant termination press-in

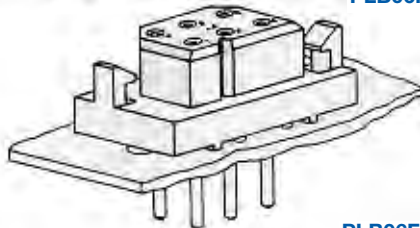

PLB06F3N0C1

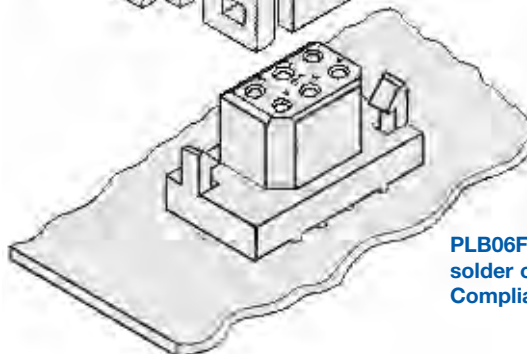

PLB06F300A1 Straight
solder or PLB06F93ST30A1
Compliant termination press-in



SYSTEM 5
CABLE TO RIGHT ANGLE
(90°) BOARD MOUNTING

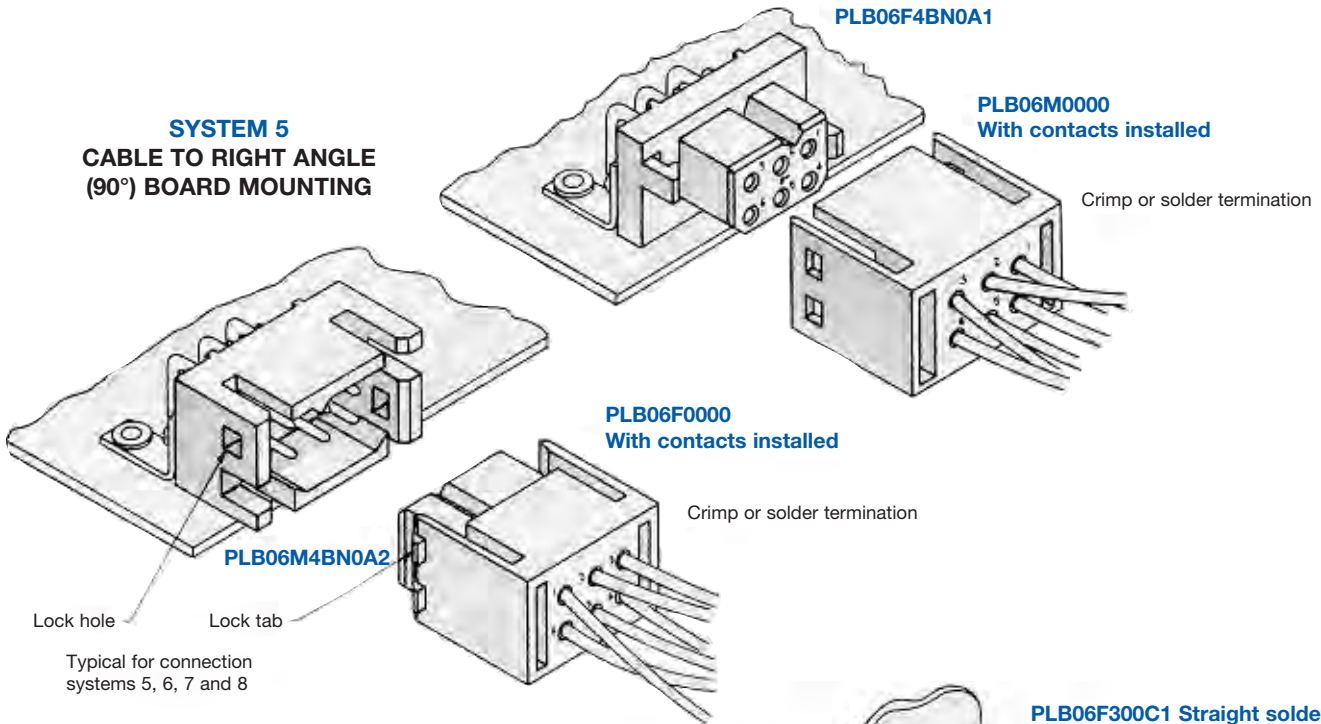

SYSTEM 6
CABLE TO STRAIGHT
BOARD MOUNTING

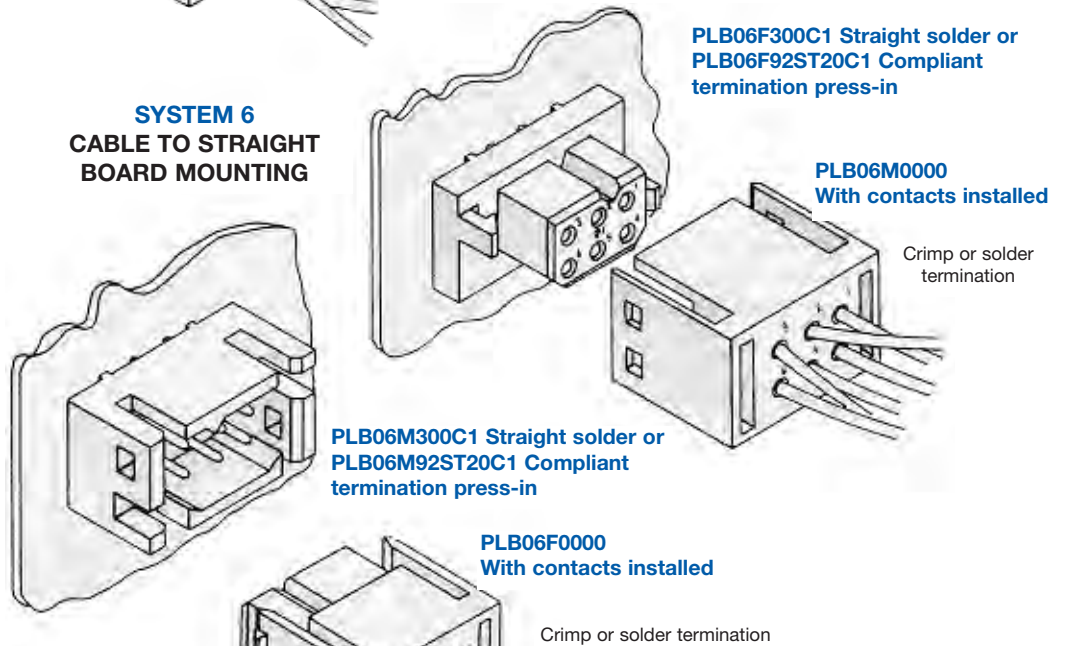

SYSTEM 7
CABLE TO CABLE

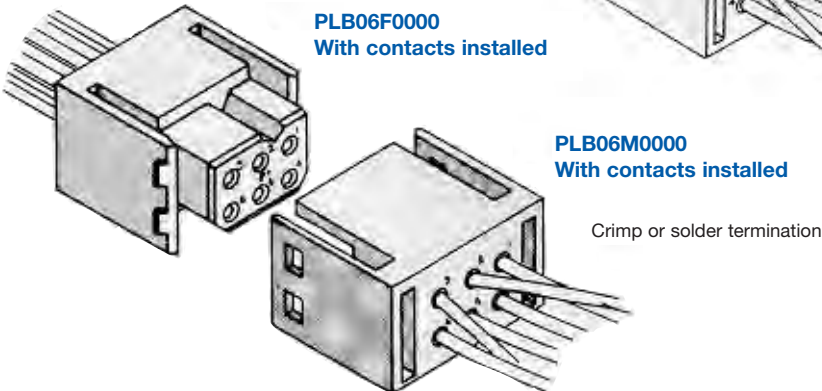



Positronic
connectpositronic.com

PANEL MOUNT & CABLE ADAPTERS CONNECTION SYSTEMS

Power
Connection
Systems

SYSTEM 8 PANEL MOUNTED TO CABLE

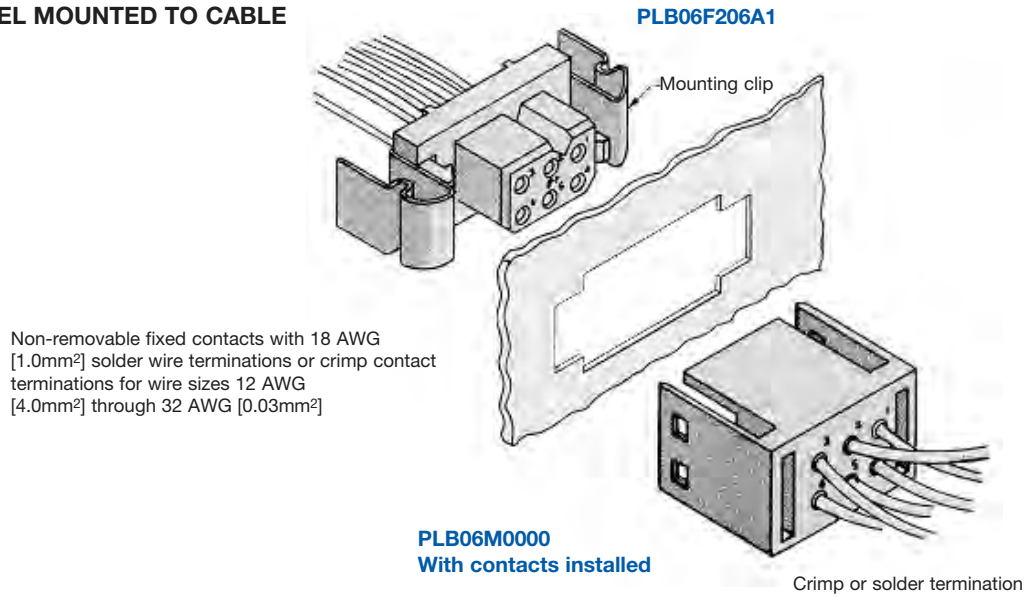

SYSTEM 9 CABLE CONNECTOR WITH CABLE ADAPTER

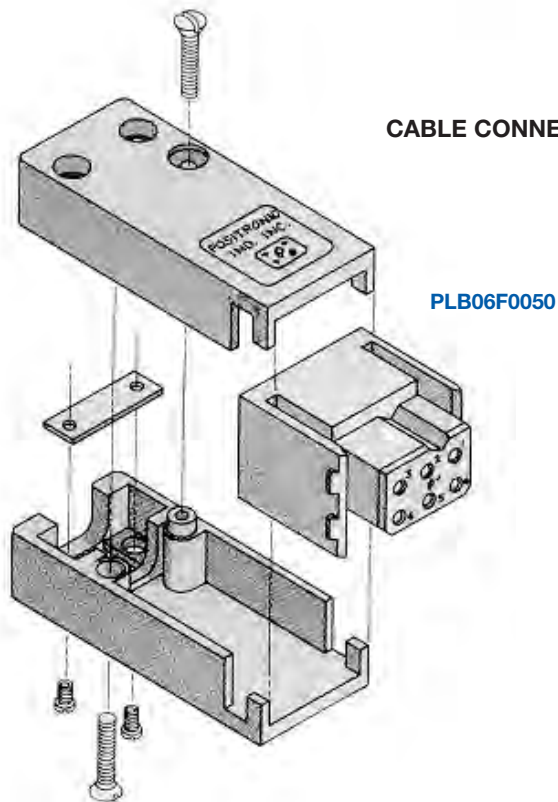



INTEGRAL FEED THROUGH CONNECTION SYSTEM ALLOWS THREE WAY INTERFACE

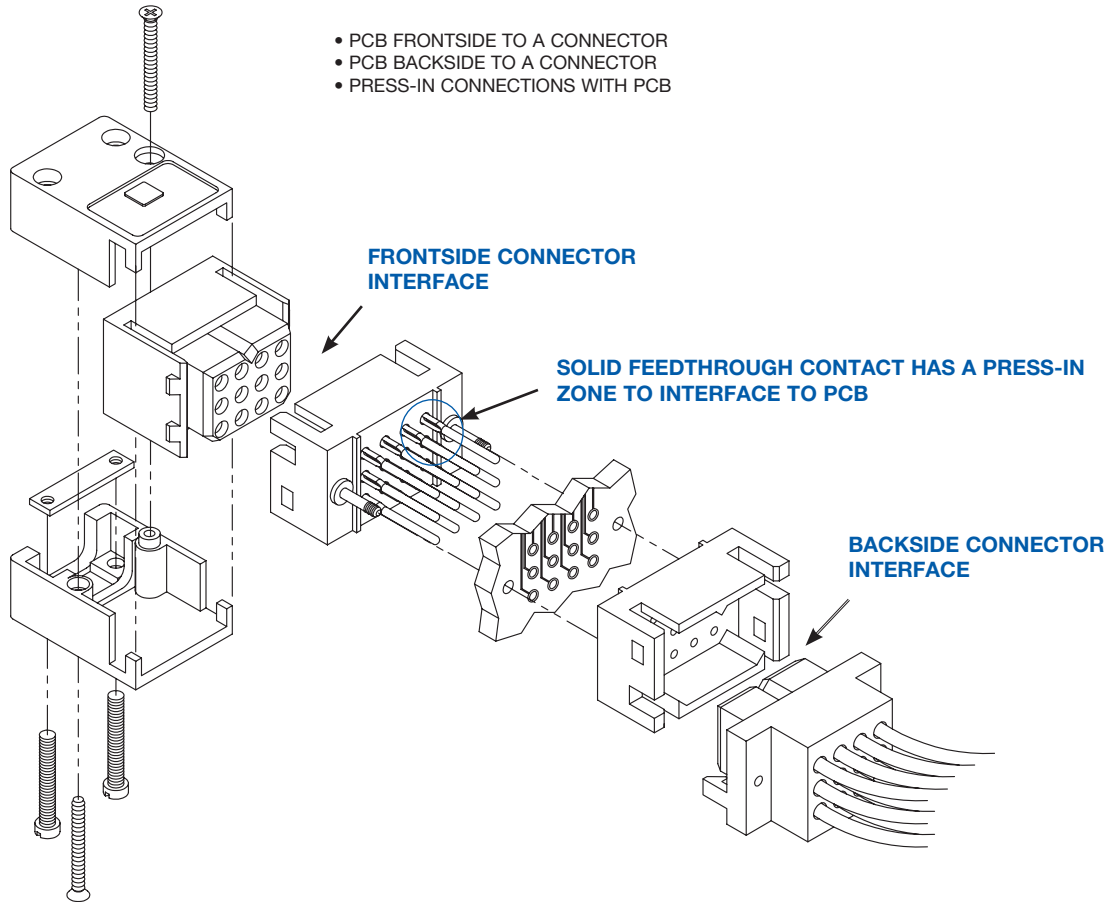

CONTACT TECHNICAL SALES FOR MORE INFORMATION.



DEMYSTIFYING CURRENT RATINGS

Connector current ratings seem to be shrouded in mystery at times. The user wonders how a listed current rating is relevant to a particular application. Perhaps more mysterious is how similar connectors from various manufacturers list different current rating values. While it is true that material choices and design can enhance a connector's current rating, the test method by which the rating was developed must be understood when evaluations are made.

Users of connectors for power applications are entitled to current rating test details in order to make an informed choice. Ideally, a connector's current rating should be developed within the application for which it is being considered. Although ideal, this approach is not always practical given the many differing applications. In order for connector manufacturers to give potential product users an idea of what can be expected, connectors are given current ratings based on a specific test method.

A wide variety of test methods are employed in order to develop current ratings for connectors. Some of these methods come from standards that are recognized industry-wide, while others are unique to the manufacturer or user. These various test methods can produce different results for the same product. It is no wonder confusion sometimes results.

There are key factors that, when understood, can help in choosing the right power connector. All test methods used to rate current have similarities; however, there are variables in applying the test methods which explain differing results.

Current ratings are usually established by first developing a temperature rise curve. This curve plots temperature rise against increasing current levels. The curve is a reliable tool in understanding heat generation of the connector at various currents. When a defined failure is reached, the test ends. The highest current level achieved is usually listed as the current rating.

The temperature rise curve, and therefore the current rating, will change when certain key factors are varied.

These are:

- Where is the temperature sensing probe placed? If placed on the contact in the mating area (the hottest spot), the results will be quite different than if placed on the outside of the connector body.
- Are the contacts being tested and rated in free air or are they contained within the connector housing? Contacts will obviously be cooler in free air.
- Are all of the contacts in the connector under load? If only part of the contacts are under load, the temperature rise could be less.
- What is the defined failure? Does the test end when the temperature rise reaches 30°C, 40°C, or some other number? Does it end when the temperature rise plus ambient temperature equal the operating limit of the connector housing? The current rating will be fixed by the defined failure point.
- How were the test samples prepared? Were the samples energized through a printed circuit board? How many layers? How large were the traces? What was the weight of the copper? Were the samples energized through wire? What size was the wire? How long was the wire? Was the sample tested in static or forced air conditions? All of these factors can affect cooling characteristics.

Clearly, a current rating value alone is not enough, and must be viewed in the context of the test used to develop the rating. When the test method is understood, evaluating and comparing power connectors for specific applications becomes much less of a mystery.

THE PCS SERIES utilizes Positronic
LARGE SURFACE AREA CONTACT MATING SYSTEM

- Separates mechanical and electrical functions for superior performance
- Low contact resistance provides minimized voltage drop across the contact
- True closed entry design prevents damage to female contacts and will not allow misaligned or bent contacts to enter
- Precision machined from solid copper alloy
- Stable insertion and withdrawal forces throughout repeated mating cycles

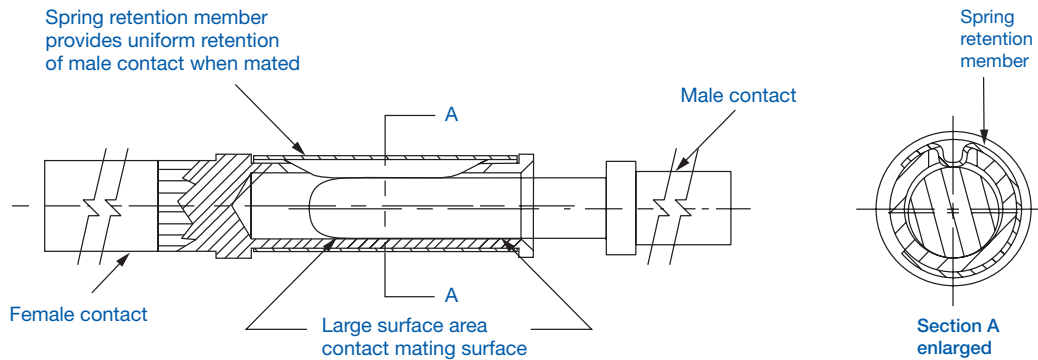

WHY IS THE L.S.A. SYSTEM SUPERIOR?

The primary function of connector contact is electrical conductivity. Also, a mechanical function is required to provide normal force between male and female contacts.

In order to provide for proper mechanical characteristics, material that has good memory or “elasticity” must be chosen. This will ensure contact normal force in a coupled condition and allow for repeated coupling and uncoupling.

Unfortunately, many materials that have good memory characteristics have low electrical conductivity. For instance, beryllium copper is a good choice for mechanical function; however, some beryllium copper alloys are poor conductors and have relatively low conductivity

rates.

The conductivity path of many contact designs goes directly through materials that have been chosen based on mechanical need. If these materials have a low conductivity rating, increased contact resistance will result.

Positronic Large Surface Area Contact System separates the mechanical and electrical functions. A spring retention member provides normal forces, while the electrical conductivity path is through highly conductive contact material. See above detail.



BI-SPRING POWER PRESS-IN TERMINATIONS

The Next Evolution In Compliant Technology. Fully Compliant, Fully Reliable.

Reliable, solderless connections from connectors to backplanes started with solid press-in technology. Although these are still used today, concerns about board damage led to the use of compliant press-in technology. This technology allows the connection to be made through compliance of the contact termination along with printed circuit board hole deformation. Although risk of damaged printed circuit boards and backplanes is lessened, damage can still occur due to

relatively high insertion and extraction forces.

The next step in press-in technology is a highly reliable connection between the contact termination and backplane that is accomplished with reduced insertion and extraction forces. This eliminates risk of printed circuit, board and backplane damage. This technology exists today with Positronic Bi-Spring Power Press-in termination.

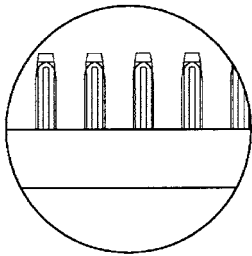

Bi-Spring Power Press-in Compliant Terminations

- Average insertion and extraction forces of size 16 contacts are 22N [5 lbs.] per contact and do not produce stresses in printed circuit boards and backplanes that can occur with higher insertion forces. These stresses can cause board warpage and hole damage.
- Connector systems utilizing Bi-Spring terminations use mounting screws to secure the connector to the printed circuit board or backplane. Stresses that occur during coupling, uncoupling or shock and vibration of systems are not transferred to the printed circuit boards or backplanes through the press-in connection. The electrical integrity of the connector to board interface is maintained; this is particularly important in power applications. Bellcore GR1217 details a preference for mounting hardware when using press-in terminations.
- Size 16 Bi-Spring terminations are designed to meet the performance requirements and hole diameters as listed in the internationally recognized specification IEC 60352-5.
- Lower insertion and extraction forces eliminate the need for expensive pressing equipment.

COMPLIANT TERMINATION PRESS-IN CONNECTOR

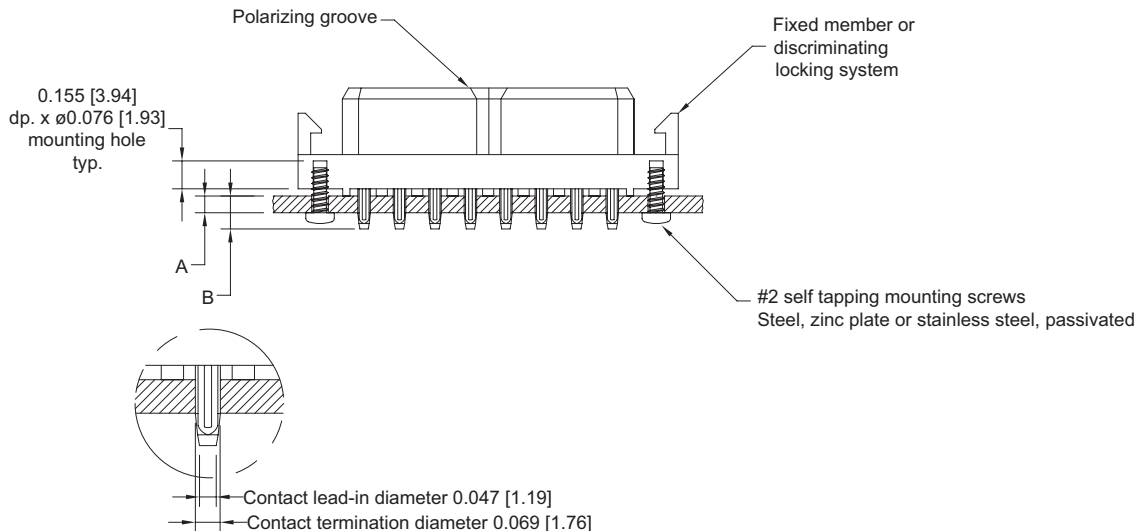

The design of Power Connection Systems Series connectors allows for the development of application specific contact arrangements in a timely manner and at a reasonable price. Thirteen connector housing sizes exist that may accommodate size 20, size 16, size 12, or size 8 contacts (see the Power Connection Systems catalog for connector housing dimensions). After reviewing the dimensions and the following basic information, contact Technical Sales with your current, voltage, and safety requirements. We look forward to working with you to develop a connector for your specific needs.

BASIC CONNECTOR DIMENSIONS

Male Connector Dimensions

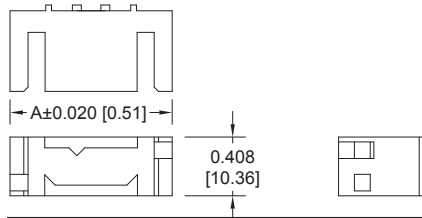

PART NUMBER	A
PLA03**00A1 PLAH03**00A1	1.126 [28.60]
PLA04**00A1 PLAH04**00A1	1.324 [33.63]
PLA06**00A1 PLAH06**00A1	1.718 [43.64]
PLA08**00A1 PLAH08**00A1	2.112 [53.64]

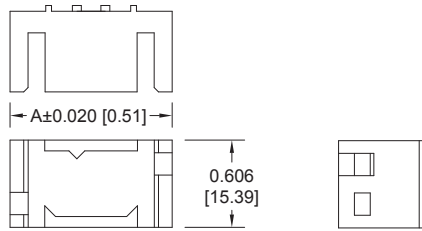

PART NUMBER	A
PLB06**00A1 PLBH06**00A1	1.126 [28.60]
PLB08**00A1 PLBH08**00A1	1.324 [33.63]
PLB12**00A1 PLBH12**00A1	1.718 [43.64]
PLB16**00A1 PLBH16**00A1	2.112 [53.64]
PLB20**00A1 PLBH20**00A1	2.506 [63.65]

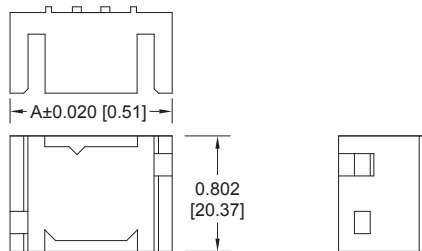

PART NUMBER	A
PLC09**00A1 PLCH09**00A1	1.126 [28.60]
PLC12**00A1 PLCH12**00A1	1.324 [33.63]
PLC18**00A1 PLCH18**00A1	1.718 [43.64]
PLC24**00A1 PLCH24**00A1	2.112 [53.64]
PLC30**00A1 PLCH30**00A1	2.506 [63.65]

Female Connector Dimensions

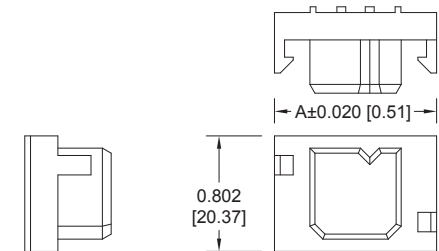
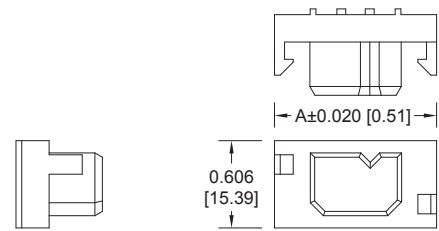
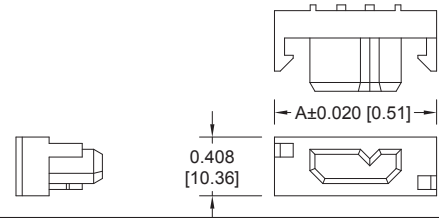

Four Contact Sizes to Choose From

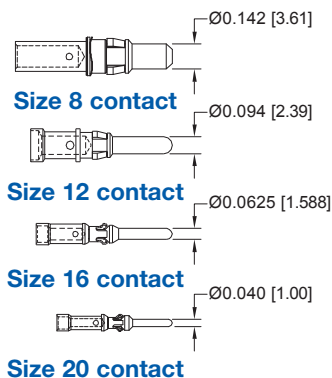

Many Termination Types Can Be Supplied

- Straight Solder or Press-in
- Right Angle (90°) Solder
- Crimp Removable
- Removable Solder Cup

Popular Options

- Sequential Mating
- Selective Loading

Contact sizes and termination types may be mixed within a single connector.



TECHNICAL CHARACTERISTICS

MATERIALS AND FINISHES:

Insulator:	Glass-filled polyester, UL 94V-0. Contact technical sales for availability of high temperature insulator material.
Contacts:	Precision machined copper alloy with gold flash over nickel, or 0.000030 inch [0.76µ] gold over nickel, or 0.000050 [1.27µ] gold over nickel. Solder coated terminations optional.
Mounting Clip:	Beryllium copper with nickel plate.
Hood:	Glass filled polyester, UL 94V-0.
Mounting Bracket:	Brass with tin plate.
Push-on Fastener:	Spring tempered copper alloy, tin plate

ELECTRICAL CHARACTERISTICS:

CONTACT CURRENT RATING:

Standard Contact Material:	See page 9 for detail information.
High Conductivity Contact Material:	See page 9 for detail information.

INITIAL CONTACT RESISTANCE:

Standard Contact Material:	0.0016 ohms max. per IEC 60512-2, test 2b.
High Conductivity Contact Material:	0.0007 ohms max. per IEC 60512-2, test 2b.
Insulation Resistance:	5 G ohms per IEC 60512-2, test 3a, method A.
Voltage Proof:	2000 V rms per IEC 60512-2, test 4a, method C.
Creepage Distance:	0.157 inch [4 mm] minimum.
Clearance Distance:	0.125 inch [3.2 mm] minimum.
Working Voltage:	Designed to meet UL 600 VAC and CSA 600 VAC.
Working Temperature:	-55°C to +125°C Contact technical sales for availability of high temperature insulator material.

ELECTRICAL CHARACTERISTICS OF COMPLIANT PRESS-IN CONNECTION TO PLATED-THROUGH-HOLE OF PRINTED BOARD:

	0.064 inch [1.63mm] diameter hole of a 0.125 inch [3.2mm] thick printed board
Initial Contact Resistance of Connection:	Less than 1.0 milliohms per IEC 60512-2, test 2a.
Change in Contact Resistance of Connection After Mechanical, Electrical or Climactic Conditioning:	Less than 0.5 milliohms increase per IEC 60512-2, test 2a.
Gas Tight Connections Test:	Less than 0.2 milliohms increase in contact resistance after 1 hour per EIA 364, TP36, Method One.

SHIELDED CONTACT TECHNICAL CHARACTERISTICS:

See page 47.

MECHANICAL CHARACTERISTICS:

Removable Contacts:	Insert contact to rear face of insulator, release from front face of insulator. Size 16, 0.0625 inch [1.588 mm] diameter male contact. Female contact "closed entry" design for highest reliability.
Removable Contact Retention in Insulator:	15 lbs. [67N] per IEC 60512-8, test 15a.
Fixed Contacts:	Solder cup and printed board terminations. Size 16, 0.0625 inch [1.588 mm] diameter male contact. Female contact has "closed entry" design for highest reliability.
Fixed Contact Retention in Insulator:	6 lbs. [26N].
Resistance to Solder Iron Heat:	500°F [260°C] for 10 seconds duration per IEC 60512-6, test 12e, 25 watt soldering iron.
Contact Terminations:	Crimp or solder removable contacts from wire sizes 12 AWG [4.0 mm ²] through 24 AWG [0.25 mm ²]. Straight and Right Angle (90°) solder printed board mount, 0.0625 inch [1.588 mm] tail diameter. Compliant termination press-in. Fixed contact solder cup termination, 18 AWG [1.0 mm ²] maximum.
Contact Insertion and Withdrawal Forces:	8 oz. [2.2N] nominal per contact.
Connection Systems:	Connector provides cable to cable, cable to printed board, cable to panel mount and printed board to printed board application.
Sequential Mating System:	Cable and printed board mount connectors. Male contacts provide as many as three mating lengths.
Locking System:	Insulators provide locking between cable to cable, cable to printed board and cable to panel mount applications.
Polarizations:	Provided in insulator design. Further polarization in cable connectors can be provided by mixing male contacts in female insulators and female contacts in male insulators.
Mounting to Printed Board:	Rapid installation push-on fasteners. Self-tapping screws for compliant connectors.
Mechanical Operations:	500 operations per IEC 60512-5.

MECHANICAL CHARACTERISTICS OF COMPLIANT PRESS-IN CONNECTORS:

Press-in Contact Bi-Spring Construction, Compliant Termination:	0.0695 inch [1.77mm] diameter with 0.050 inch [1.27mm] lead-in diameter. Offered with two termination lengths.
Contact Retention in Insulator and 0.125 inch [3.2mm] thick printed board:	5 lbs. [22N] minimum combined retention forces per MIL-STD-2166, Type III compliant contact classification, after third repair-replacement of contact in insulator and plated-through-hole, 0.064 inch [1.63mm] diameter in a 0.125 inch [3.2mm] thick printed board.
Vibration:	No electrical discontinuity of 1µ second or greater when tested per MIL-STD-1344, Method 2005, Test conditioning.
Initial Press-In Force of Individual Contact into Plated-Through-Hole:	10 lbs. [44N] average when pushed into a 0.064 inch [1.63mm] Ø hole in a 0.125 inch [3.2mm] thick printed board.
Initial Push-Out Force of Individual Contact into Plated-Through-Hole:	8.5 lbs. [38N] average when pushed out of an 0.064 inch [1.63mm] Ø hole in a 0.125 inch [3.2mm] thick printed board.

CUL Recognized*

File # E49351

*Note: CUL recognizes all sizes, except PLB20, consult Technical Sales for status.

TEMPERATURE RISE CURVE

STANDARD CONTACT MATERIALS

CONNECTORS WITH PL* PREFIX

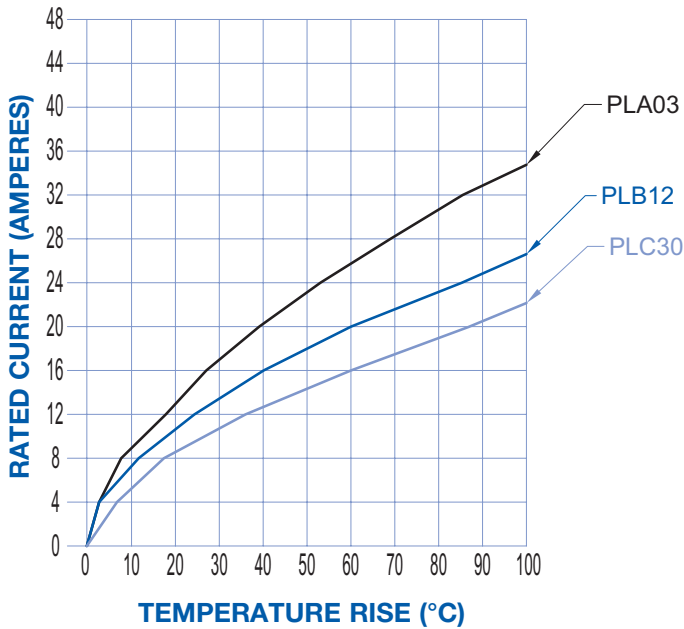

HIGH CONDUCTIVITY CONTACT MATERIALS

CONNECTORS WITH PL*H PREFIX
OR "S" SUFFIX ON CRIMP CONTACTS

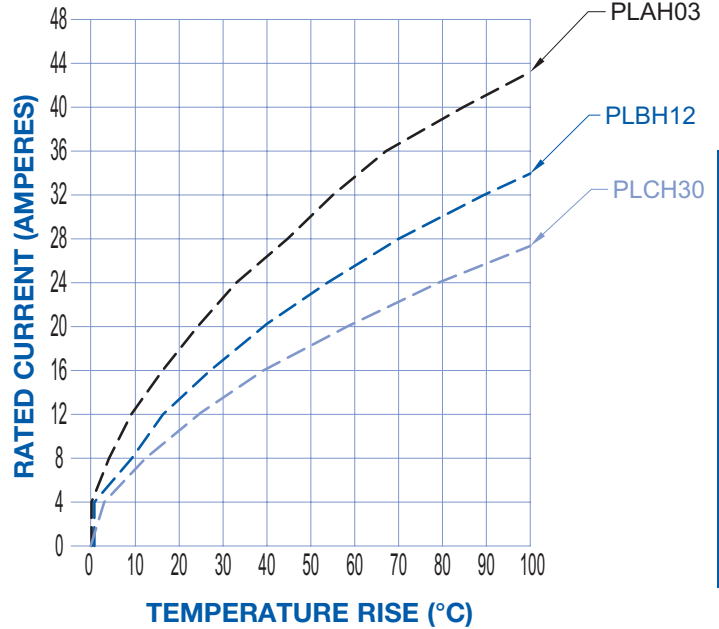

TEST DETAIL: Each curve was developed using individual connector bodies fully loaded with contacts. All power contacts energized through 12 awg wire. Temperature rise was measured in the contact mating area. Test was conducted with connectors in static air. Terminations of test connectors were straight compliant press-in to right angle (90°) solder. See page 4 for more information.

CONTACT CURRENT RATINGS			
CONNECTOR VARIANT	STANDARD CONTACTS	CONNECTOR VARIANT	HIGH CONDUCTIVITY CONTACTS
PLA03	32 amperes	PLAH03	42 amperes
PLB12	25 amperes	PLBH12	32 amperes
PLC30	18 amperes	PLCH30	24 amperes

Temperature rise curves and contact current ratings were developed for the specific connector variants shown when tested in accordance with UL1977.

This information is provided so that the user can make comparisons between various connector sizes and contact materials.



MATING DIMENSIONS (FULLY MATED)

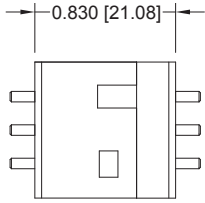

**Straight Board Mount Male
to Straight Board Mount
Female**

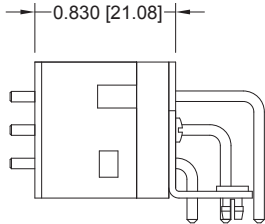

**Straight Board Mount Male
to Right Angle (90°) Board
Mount Female**

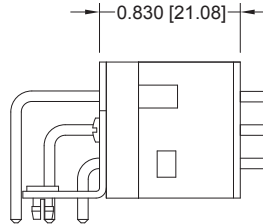

**Right Angle (90°) Board
Mount Male to Straight
Board Mount Female**

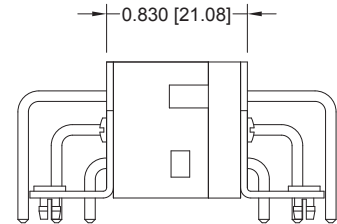

**Right Angle (90°) Board
Mount Male to Right Angle
(90°) Board Mount Female**

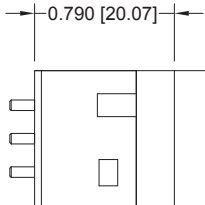

**Straight Board Mount Male
to Panel Mount
Female**



**Panel Mount Male
to Straight Board
Mount Female**

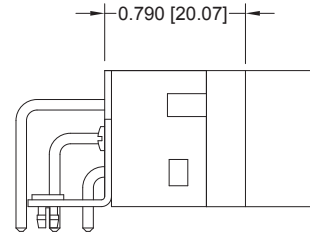

**Right Angle (90°) Board
Mount Male to Panel
Board Mount Female**

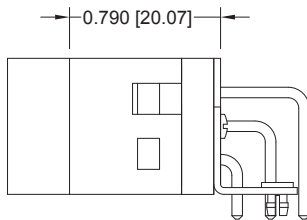

**Panel Mount Male
to Right Angle (90°) Board
Mount Female**

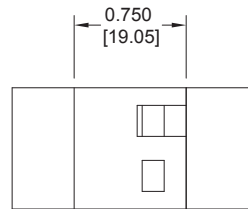

**Panel Mount Male
to Panel Mount
Female**

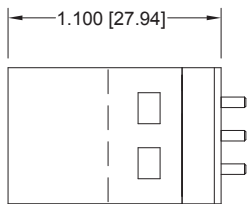

**Cable Mount Male
to Straight Board
Mount Female**

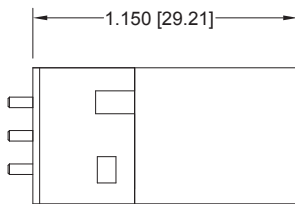

**Straight Board Mount
Male to Cable
Mount Female**

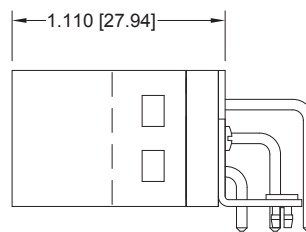

**Cable Mount Male
to Right Angle (90°)
Board Mount Female**

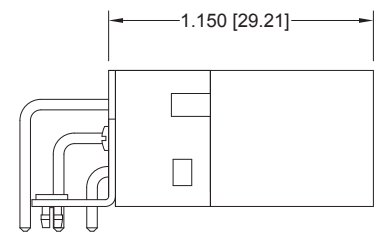

**Right Angle (90°) Board Mount
Male to Cable Mount
Female**

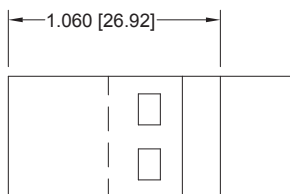

**Cable Mount Male
to
Panel Mount Female**

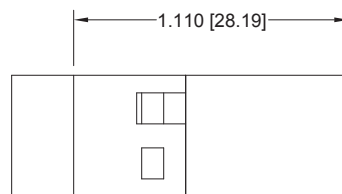

**Panel Mount Male
to Cable Mount
Female**

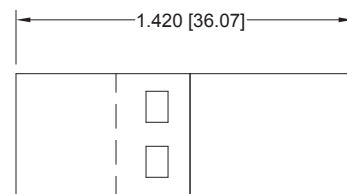

**Cable Mount Male
to
Cable Mount Female**

PCS SERIES

PLA STRAIGHT PRINTED BOARD MOUNT CONNECTORS

CODE 3, 0.146 [3.71] CONTACT EXTENSION

Positronic recommends the practice of using mounting hardware to secure connector to printed circuit board.

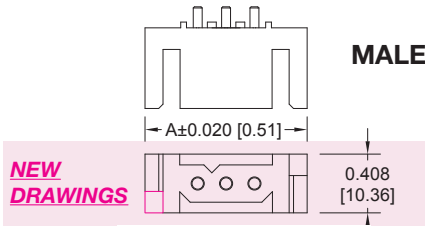

NEW
DRAWINGS

Typical part number:
PLA03M300A1
PLAH03M300A1

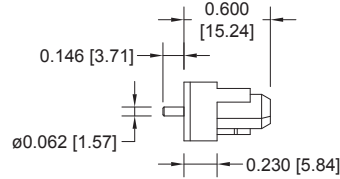
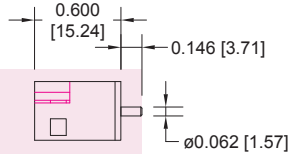

FEMALE

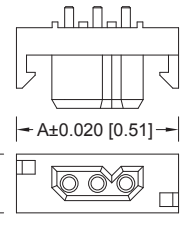

Typical part number:
PLA03F300A1
PLAH03F300A1

PART NUMBER	A	PART NUMBER	A
PLA03*300A1	1.126 [28.60]	PLA06*300A1	1.718 [43.64]
PLAH03*300A1		PLAH06*300A1	
PLA04*300A1	1.324 [33.63]	PLA08*300A1	2.112 [53.64]
PLAH04*300A1		PLAH08*300A1	

*Asterisk determines gender of connector, M for male, F for female.

Plating- See ordering information for contact plating options.

For connection systems 1, 4 and 6.

NOTE: MOUNTING SCREWS CAN BE SUPPLIED WITH CONNECTORS USING STEP 5 IN ORDERING INFORMATION ON PAGE 26. MOUNTING SCREWS CAN ALSO BE ORDERED SEPARATELY BY PART NUMBER. SEE PAGE 59.

PLB STRAIGHT PRINTED BOARD MOUNT CONNECTORS

CODE 3, 0.146 [3.71] CONTACT EXTENSION

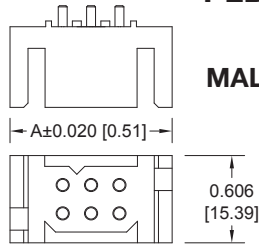

MALE

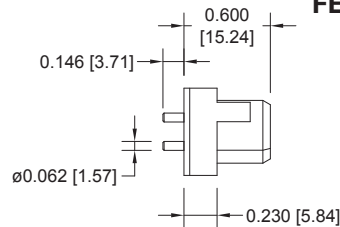
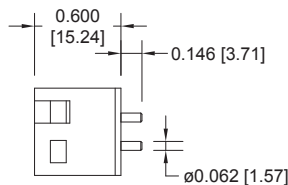

FEMALE

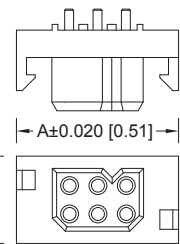

Typical part number:
PLB06F300A1
PLAH06F300A1

PART NUMBER	A	PART NUMBER	A
PLB06*300A1	1.126 [28.60]	PLB16*300A1	2.112 [53.64]
PLBH06*300A1		PLBH16*300A1	
PLB08*300A1	1.324 [33.63]	PLB20*300A1	2.506 [63.65]
PLBH08*300A1		PLBH20*300A1	
PLB12*300A1	1.718 [43.64]		
PLBH12*300A1			

*Asterisk determines gender of connector, M for male, F for female.

Plating- See ordering information for contact plating options.

For connection systems 1, 4 and 6.

Typical part number:
PLB06M300A1
PLBH06M300A1

NOTE: MOUNTING SCREWS CAN BE SUPPLIED WITH CONNECTORS USING STEP 5 IN ORDERING INFORMATION ON PAGE 26. MOUNTING SCREWS CAN ALSO BE ORDERED SEPARATELY BY PART NUMBER. SEE PAGE 59.

PLC STRAIGHT PRINTED BOARD MOUNT CONNECTORS

CODE 3, 0.146 [3.71] CONTACT EXTENSION

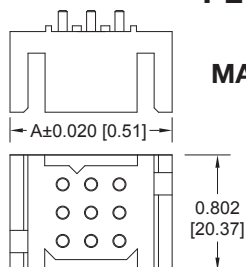

MALE

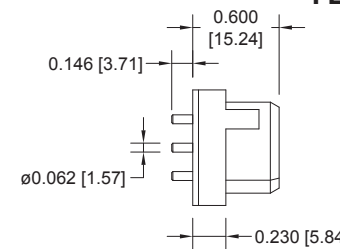
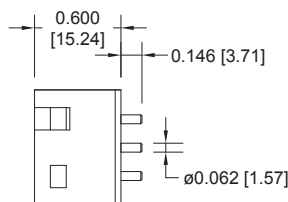

FEMALE

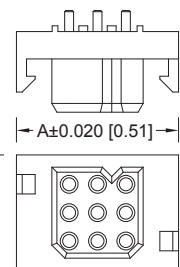

Typical part number:
PLC09F300A1
PLCH09F300A1

PART NUMBER	A	PART NUMBER	A
PLC09*300A1	1.126 [28.60]	PLC24*300A1	2.112 [53.64]
PLCH09*300A1		PLCH24*300A1	
PLC12*300A1	1.324 [33.63]	PLC30*300A1	2.506 [63.65]
PLCH12*300A1		PLCH30*300A1	
PLC18*300A1	1.718 [43.64]		
PLCH18*300A1			

*Asterisk determines gender of connector, M for male, F for female.

Plating- See ordering information for contact plating options.

For connection systems 1, 4 and 6.

NOTE: MOUNTING SCREWS CAN BE SUPPLIED WITH CONNECTORS USING STEP 5 IN ORDERING INFORMATION ON PAGE 26. MOUNTING SCREWS CAN ALSO BE ORDERED SEPARATELY BY PART NUMBER. SEE PAGE 59.

DIMENSIONS ARE IN INCHES [MILLIMETERS]. ALL DIMENSIONS ARE SUBJECT TO CHANGE.



Positronic
connectpositronic.com

STRAIGHT SOLDER PRINTED BOARD CONNECTOR

Power
Connection
Systems

PLA STRAIGHT PRINTED BOARD MOUNT CONNECTORS CODE 32, 0.377 [9.58] CONTACT EXTENSION

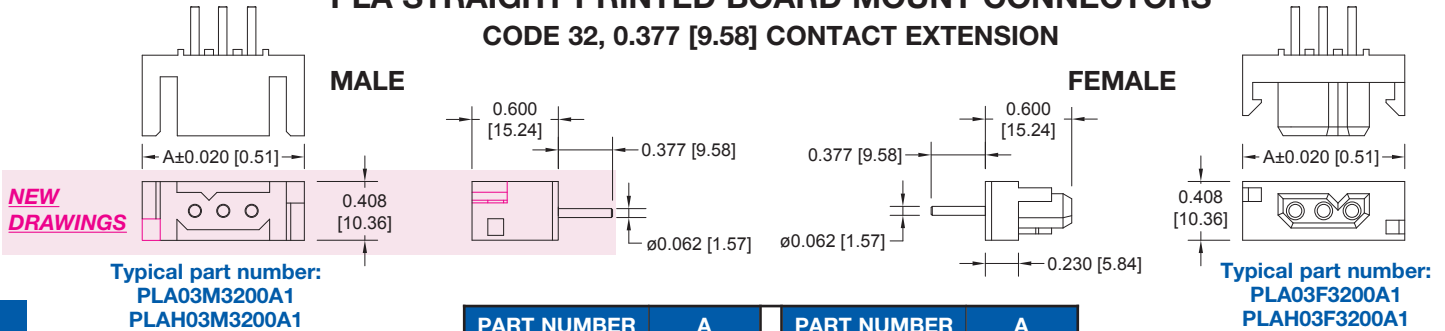

Typical part number:
PLA03M3200A1
PLAH03M3200A1

Typical part number:
PLA03F3200A1
PLAH03F3200A1

NOTE: MOUNTING SCREWS CAN BE SUPPLIED WITH CONNECTORS USING STEP 5 IN ORDERING INFORMATION ON PAGE 26. MOUNTING SCREWS CAN ALSO BE ORDERED SEPARATELY BY PART NUMBER. SEE PAGE 59.

PART NUMBER	A	PART NUMBER	A
PLA03*3200A1 PLAH03*3200A1	1.126 [28.60]	PLA06*3200A1 PLAH06*3200A1	1.718 [43.64]
PLA04*3200A1 PLAH04*3200A1	1.324 [33.63]	PLA08*3200A1 PLAH08*3200A1	2.112 [53.64]

*Asterisk determines gender of connector, M for male, F for female.

Plating- See ordering information for contact plating options.

For connection systems 1, 3, 4 and 6.

PLB STRAIGHT PRINTED BOARD MOUNT CONNECTORS CODE 32, 0.377 [9.58] CONTACT EXTENSION

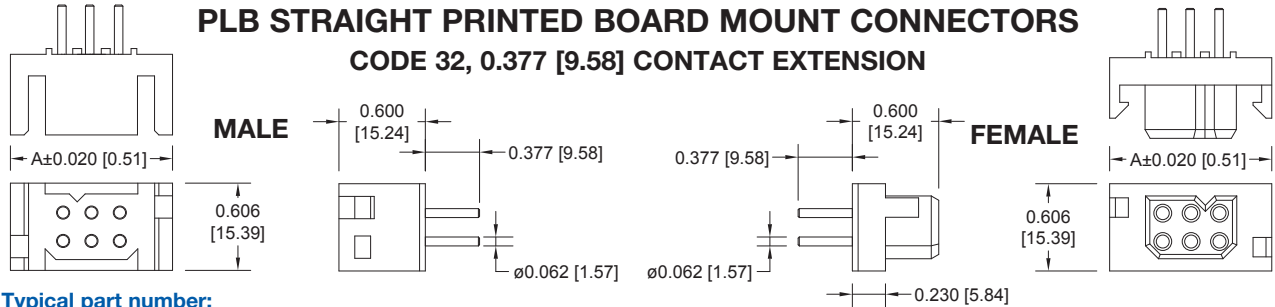

Typical part number:
PLB06M3200A1
PLBH06M3200A1

Typical part number:
PLB06F3200A1
PLBH06F3200A1

NOTE: MOUNTING SCREWS CAN BE SUPPLIED WITH CONNECTORS USING STEP 5 IN ORDERING INFORMATION ON PAGE 26. MOUNTING SCREWS CAN ALSO BE ORDERED SEPARATELY BY PART NUMBER. SEE PAGE 59.

PART NUMBER	A	PART NUMBER	A
PLB06*3200A1 PLBH06*3200A1	1.126 [28.60]	PLB16*3200A1 PLBH16*3200A1	2.112 [53.64]
PLB08*3200A1 PLBH08*3200A1	1.324 [33.63]	PLB20*3200A1 PLBH20*3200A1	2.506 [63.65]
PLB12*3200A1 PLBH12*3200A1	1.718 [43.64]		

*Asterisk determines gender of connector, M for male, F for female.

Plating- See ordering information for contact plating options.

For connection systems 1, 3, 4 and 6.

PLC STRAIGHT PRINTED BOARD MOUNT CONNECTORS CODE 32, 0.377 [9.58] CONTACT EXTENSION

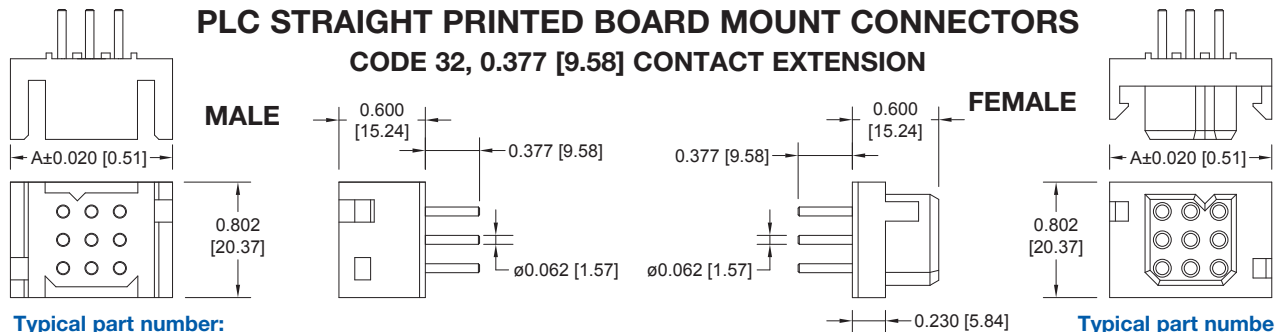

Typical part number:
PLC09M3200A1
PLCH09M3200A1

Typical part number:
PLC09F3200A1
PLCH09F3200A1

NOTE: MOUNTING SCREWS CAN BE SUPPLIED WITH CONNECTORS USING STEP 5 IN ORDERING INFORMATION ON PAGE 26. MOUNTING SCREWS CAN ALSO BE ORDERED SEPARATELY BY PART NUMBER. SEE PAGE 59.

PART NUMBER	A	PART NUMBER	A
PLC09*3200A1 PLCH09*3200A1	1.126 [28.60]	PLC24*3200A1 PLCH24*3200A1	2.112 [53.64]
PLC12*3200A1 PLCH12*3200A1	1.324 [33.63]	PLC30*3200A1 PLCH30*3200A1	2.506 [63.65]
PLC18*3200A1 PLCH18*3200A1	1.718 [43.64]		

*Asterisk determines gender of connector, M for male, F for female.

Plating- See ordering information for contact plating options.

For connection systems 1, 3, 4 and 6.

PLA COMPLIANT PRESS-IN CONNECTORS
CODE 92 OR CODE 93

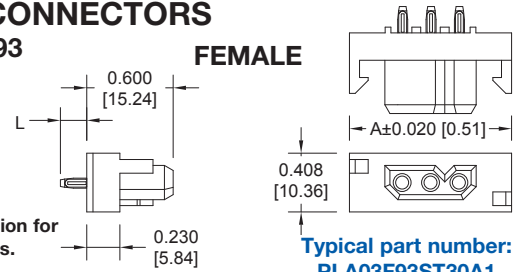
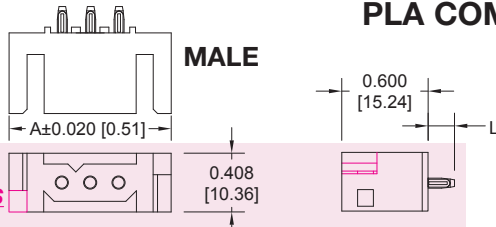

NEW
DRAWINGS

Typical part number:
PLA03M93ST30A1
PLAH03M93ST30A1

**Asterisks determine
gender of connector,
M for male,
F for female and
contact code 92 or 93.

PART NUMBER	A
PLA03**00A1 PLAH03**00A1	1.126 [28.60]
PLA04**00A1 PLAH04**00A1	1.324 [33.63]
PLA06**00A1 PLAH06**00A1	1.718 [43.64]
PLA08**00A1 PLAH08**00A1	2.112 [53.64]

See page 56
for Installation Tooling.

Plating- See ordering information for
contact plating options.
For connection systems 1, 4 and 6.

NOTE: Positronic recommends the practice of using
mounting hardware to secure connector to printed
circuit board. Mounting screws can be supplied
with connectors using step 5 in ordering information
on page 26. Mounting screws can also be ordered
separately by part number. See page 59.

Typical part number:
PLA03F93ST30A1
PLAH03F93ST30A1

CONTACT CODE	L	PCB THICKNESS
92	0.183 [4.65]	0.093 [2.36]
93	0.218 [5.54]	0.125 [3.18]

PLB COMPLIANT PRESS-IN CONNECTORS
CODE 92 OR CODE 93

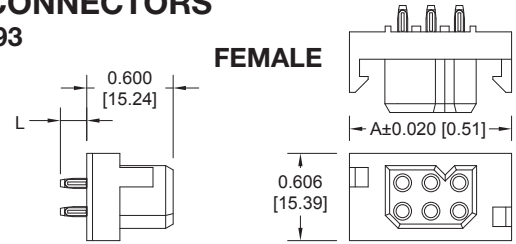
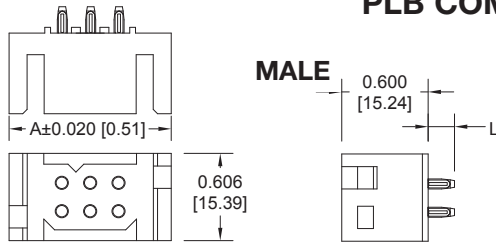

Typical part number:
PLB06M93ST30A1
PLBH06M93ST30A1

**Asterisks determine
gender of connector,
M for male,
F for female and
contact code 92 or 93.

PART NUMBER	A
PLB06**00A1 PLBH06**00A1	1.126 [28.60]
PLB08**00A1 PLBH08**00A1	1.324 [33.63]
PLB12**00A1 PLBH12**00A1	1.718 [43.64]
PLB16**00A1 PLBH16**00A1	2.112 [53.64]
PLB20**00A1 PLBH20**00A1	2.506 [63.65]

See page 56
for Installation Tooling.

Plating- See ordering information for
contact plating options.
For connection systems 1, 4 and 6.

NOTE: Positronic recommends the practice of using
mounting hardware to secure connector to printed
circuit board. Mounting screws can be supplied
with connectors using step 5 in ordering information
on page 26. Mounting screws can also be ordered
separately by part number. See page 59.

Typical part number:
PLB06F93ST30A1
PLBH06F93ST30A1

CONTACT CODE	L	PCB THICKNESS
92	0.183 [4.65]	0.093 [2.36]
93	0.218 [5.54]	0.125 [3.18]

PLC COMPLIANT PRESS-IN CONNECTORS
CODE 92 OR CODE 93

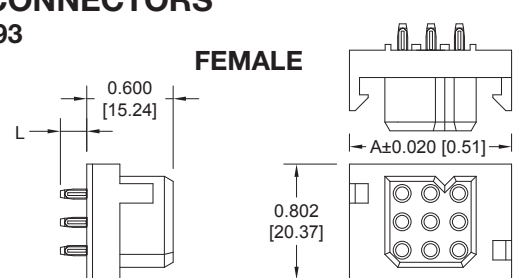
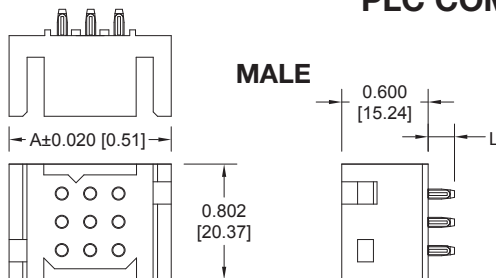

Typical part number:
PLC09M93ST30A1
PLCH09M93ST30A1

**Asterisks determine
gender of connector,
M for male,
F for female and
contact code 92 or 93.

PART NUMBER	A
PLC09**00A1 PLCH09**00A1	1.126 [28.60]
PLC12**00A1 PLCH12**00A1	1.324 [33.63]
PLC18**00A1 PLCH18**00A1	1.718 [43.64]
PLC24**00A1 PLCH24**00A1	2.112 [53.64]
PLC30**00A1 PLCH30**00A1	2.506 [63.65]

See page 56
for Installation Tooling.

Plating- See ordering information for
contact plating options.
For connection systems 1, 4 and 6.

NOTE: Positronic recommends the practice of using
mounting hardware to secure connector to printed
circuit board. Mounting screws can be supplied
with connectors using step 5 in ordering information
on page 26. Mounting screws can also be ordered
separately by part number. See page 59.

Typical part number:
PLC09F93ST30A1
PLCH09F93ST30A1

CONTACT CODE	L	PCB THICKNESS
92	0.183 [4.65]	0.093 [2.36]
93	0.218 [5.54]	0.125 [3.18]

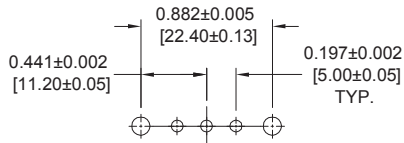

PLA 03

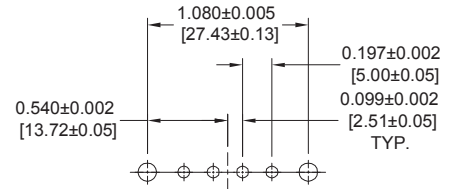

PLA 04

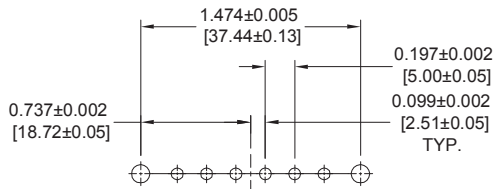

PLA 06

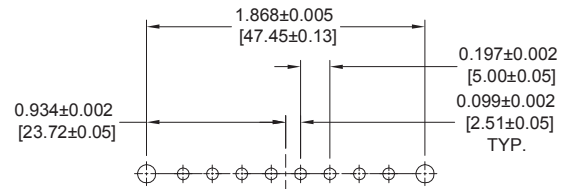

PLA 08

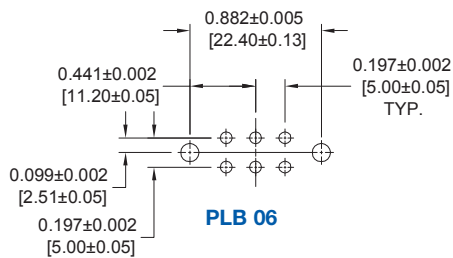

PLB 06

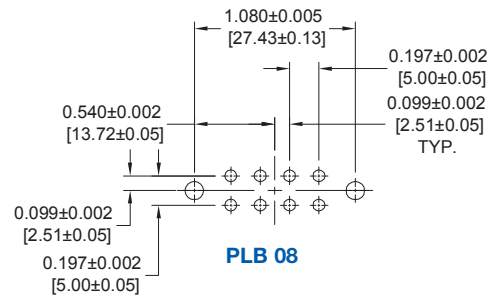

PLB 08

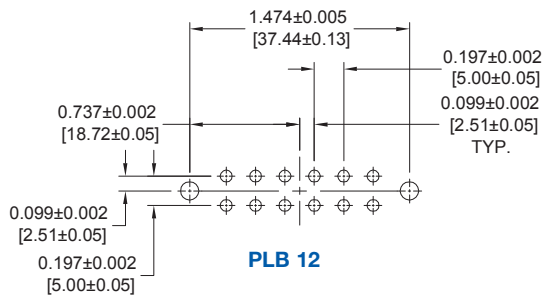

PLB 12

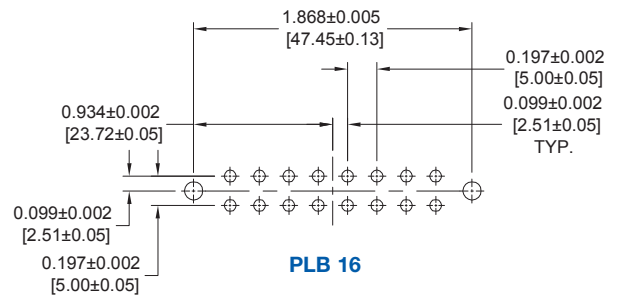

PLB 16

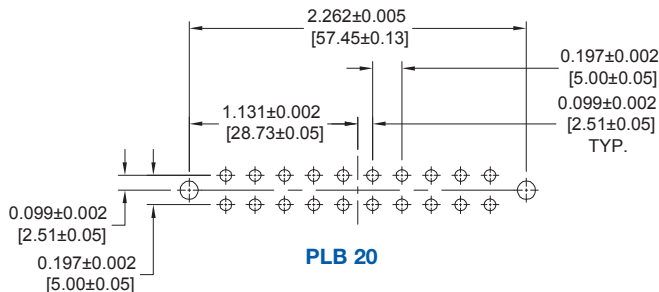

PLB 20

SUGGESTED PRINTED BOARD HOLE SIZES:

Suggest 0.080 [2.03] Ø holes in printed board for solder contact termination positions.

Suggest 0.100 [2.54] Ø holes in printed board when mounting connectors with # 2 thread forming screws.

Suggest 0.123±0.003 [3.15±0.08] Ø holes in printed board when mounting connector with push-on fasteners.

NOTE: See page 57 for suggested printed board drill hole sizes, recommended plating and finished hole sizes for compliant contact termination positions.

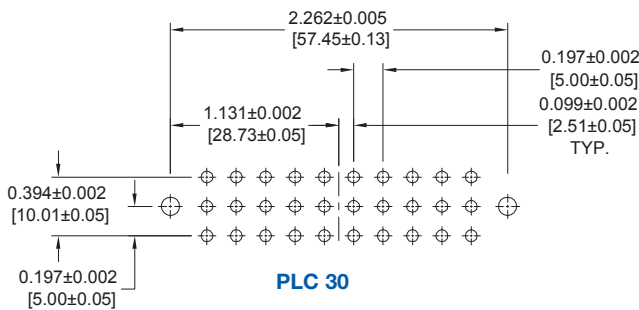
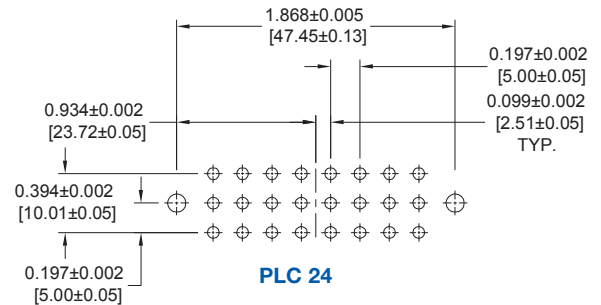
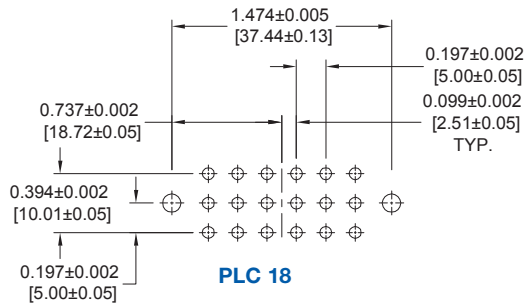
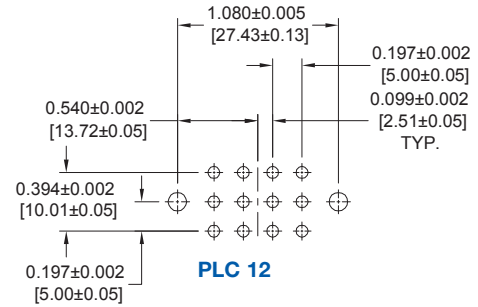
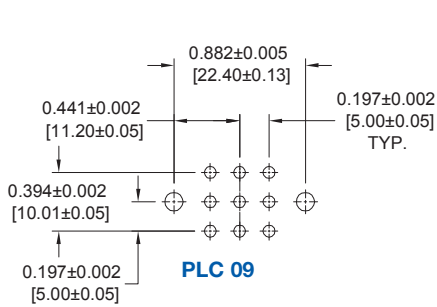

SUGGESTED PRINTED BOARD HOLE SIZES:

Suggest 0.080 [2.03] Ø holes in printed board for solder contact termination positions.

Suggest 0.100 [2.54] Ø holes in printed board when mounting connectors with # 2 thread forming screws.

Suggest 0.123±0.003 [3.15±0.08] Ø holes in printed board when mounting connector with push-on fasteners.

NOTE: See page 57 for suggested printed board drill hole sizes, recommended plating and finished hole sizes for compliant contact termination positions.

Connectors Designed To Customer Specifications

Positronic's PLA(H), PLB(H), PLC(H) and PLS(H) series connectors can be modified to customers specifications.

Examples: select loading of contacts for cost savings or to gain creepage and clearance distances; longer printed circuit board terminations; customer specified hardware.

Positronic can develop and tool new connector designs with reasonable price and delivery.

Contact Technical Sales with your particular requirements.



Positronic
connectpositronic.com

RIGHT ANGLE (90°) SOLDER PRINTED BOARD CONNECTOR

Power
Connection
Systems

PLA RIGHT ANGLE (90°) PRINTED BOARD MOUNT CODE 4, 0.146 [3.71] CONTACT EXTENSION

NEW
DRAWINGS

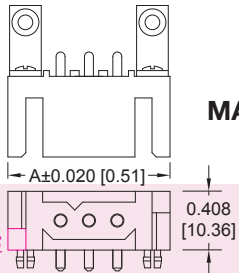

MALE

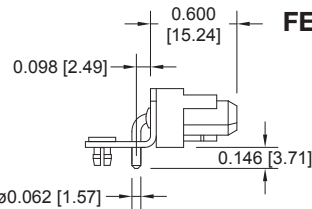
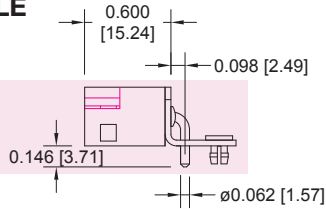

FEMALE

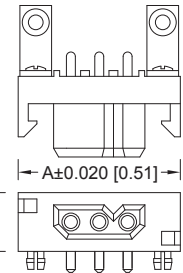

Typical part number:
PLA03M4BN0A1
PLAH03M4BN0A1

Typical part number:
PLA03F4BN0A1
PLAH03F4BN0A1

NOTE: MOUNTING SCREWS
CAN BE ORDERED
SEPARATELY BY PART
NUMBER WHEN CHOOSING
B3 BRACKETS. SEE PAGE 59.

PART NUMBER	A	PART NUMBER	A
PLA03*400A1	1.126 [28.60]	PLA06*400A1	1.718 [43.64]
PLA04*400A1	1.324 [33.63]	PLA08*400A1	2.112 [53.64]

*Asterisk determines gender of connector,
M for male, F for female.

Plating- See ordering information for
contact plating options.

For connection systems 1, 2 and 5.

PLB RIGHT ANGLE (90°) PRINTED BOARD MOUNT CODE 4, 0.146 [3.71] CONTACT EXTENSION

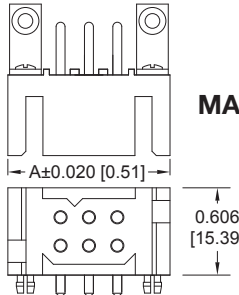

MALE

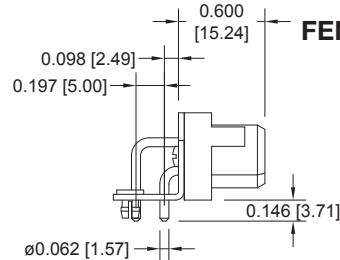
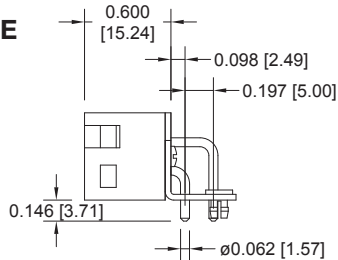

FEMALE

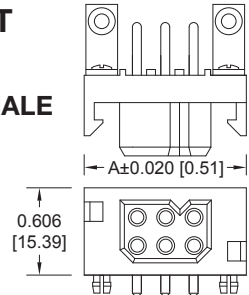

Typical part number:
PLB06M4BN0A1
PLBH06B4BN0A1

Typical part number:
PLB06F4BN0A1
PLBH06F4BN0A1

NOTE: MOUNTING SCREWS
CAN BE ORDERED
SEPARATELY BY PART
NUMBER WHEN CHOOSING
B3 BRACKETS. SEE PAGE 59.

PART NUMBER	A	PART NUMBER	A
PLB06*400A1	1.126 [28.60]	PLB16*400A1	2.112 [53.64]
PLB08*400A1	1.324 [33.63]	PLB20*400A1	2.506 [63.65]
PLB12*400A1	1.718 [43.64]		

*Asterisk determines gender of connector,
M for male, F for female.

Plating- See ordering information for
contact plating options.

For connection systems 1, 2 and 5.

PLC RIGHT ANGLE (90°) PRINTED BOARD MOUNT CODE 4, 0.146 [3.71] CONTACT EXTENSION

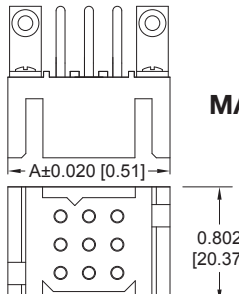

MALE

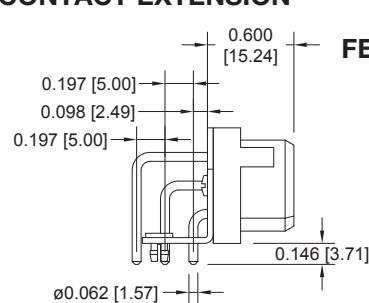
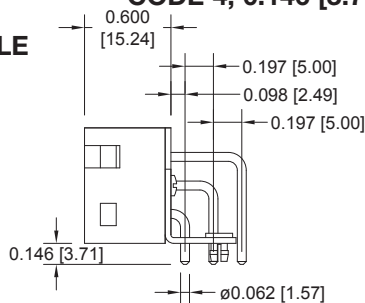

FEMALE

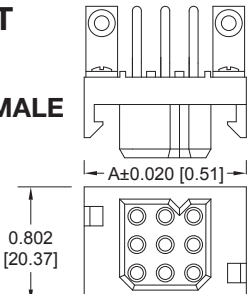

Typical part number:
PLC09M4BN0A1
PLCH09M4BN0A1

Typical part number:
PLC09F4BN0A1
PLCH09F4BN0A1

NOTE: MOUNTING SCREWS
CAN BE ORDERED
SEPARATELY BY PART
NUMBER WHEN CHOOSING
B3 BRACKETS. SEE PAGE 59.

PART NUMBER	A	PART NUMBER	A
PLC09*400A1	1.126 [28.60]	PLC24*400A1	2.112 [53.64]
PLC12*400A1	1.324 [33.63]	PLC30*400A1	2.506 [63.65]
PLC18*400A1	1.718 [43.64]		

*Asterisk determines gender of connector,
M for male, F for female.

Plating- See ordering information for
contact plating options.

For connection systems 1, 2 and 5.

PCS SERIES



PLA RIGHT ANGLE (90°) PRINTED BOARD MOUNT CODE 42, 0.377 [9.58] CONTACT EXTENSION

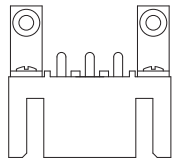

MALE

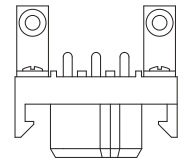

FEMALE

NEW DRAWINGS

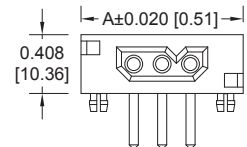
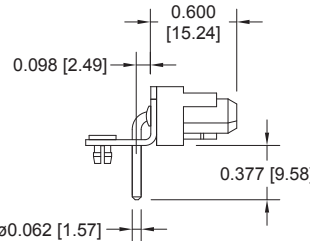
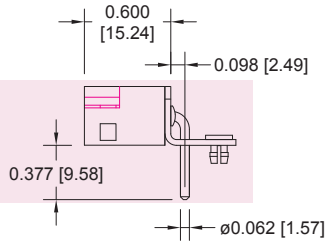
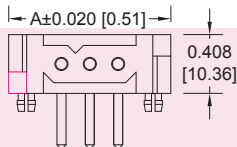

Typical part number:
PLA03M42BN0A1
PLAH03M42BN0A1

Typical part number:
PLA03F42BN0A1
PLAH03F42BN0A1

NOTE: MOUNTING SCREWS CAN BE ORDERED SEPARATELY BY PART NUMBER WHEN CHOOSING B3 BRACKETS. SEE PAGE 59.

PART NUMBER	A	PART NUMBER	A
PLA03*4200A1 PLAH03*4200A1	1.126 [28.60]	PLA06*4200A1 PLAH06*4200A1	1.718 [43.64]
PLA04*4200A1 PLAH04*4200A1	1.324 [33.63]	PLA08*4200A1 PLAH08*4200A1	2.112 [53.64]

Plating- See ordering information for contact plating options.
For connection systems 1, 2, 3 and 5.

*Asterisk determines gender of connector, M for male, F for female.

PLB RIGHT ANGLE (90°) PRINTED BOARD MOUNT CODE 42, 0.377 [9.58] CONTACT EXTENSION

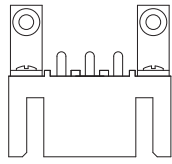

MALE

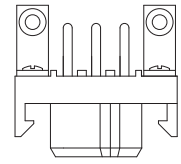

FEMALE

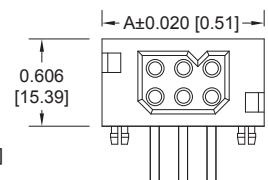
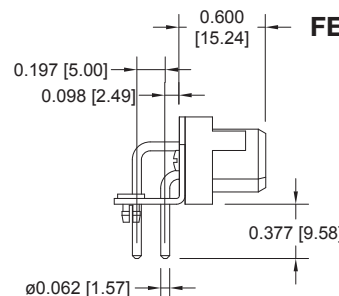
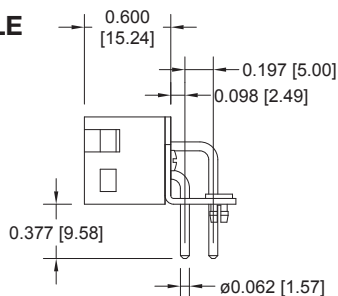
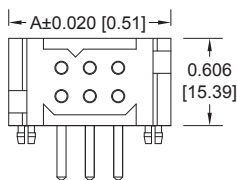

Typical part number:
PLB06M42BN0A1
PLBH06M42BN0A1

Typical part number:
PLB06F42BN0A1
PLBH06F42BN0A1

NOTE: MOUNTING SCREWS CAN BE ORDERED SEPARATELY BY PART NUMBER WHEN CHOOSING B3 BRACKETS. SEE PAGE 59.

PART NUMBER	A	PART NUMBER	A
PLB06*4200A1 PLBH06*4200A1	1.126 [28.60]	PLB16*4200A1 PLBH16*4200A1	2.112 [53.64]
PLB08*4200A1 PLBH08*4200A1	1.324 [33.63]	PLB20*4200A1 PLBH20*4200A1	2.506 [63.65]
PLB12*4200A1 PLBH12*4200A1	1.718 [43.64]		

Plating- See ordering information for contact plating options.
For connection systems 1, 2, 3 and 5.

*Asterisk determines gender of connector, M for male, F for female.

PLC RIGHT ANGLE (90°) PRINTED BOARD MOUNT CODE 42, 0.377 [9.58] CONTACT EXTENSION

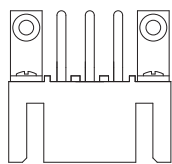

MALE

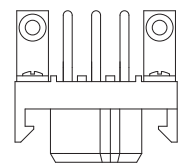

FEMALE

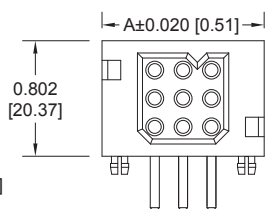
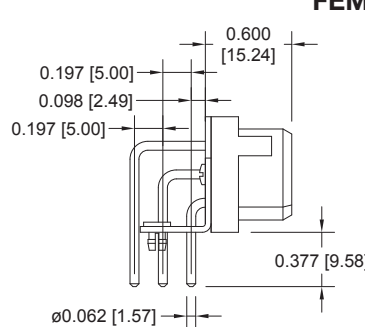
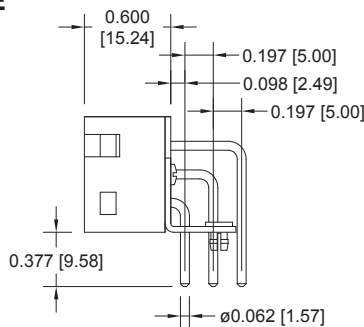
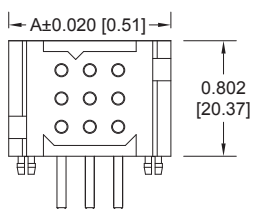

Typical part number:
PLC09M42BN0A1
PLCH09M42BN0A1

Typical part number:
PLC09F42BN0A1
PLCH09F42BN0A1

NOTE: MOUNTING SCREWS CAN BE ORDERED SEPARATELY BY PART NUMBER WHEN CHOOSING B3 BRACKETS. SEE PAGE 59.

PART NUMBER	A	PART NUMBER	A
PLC09*4200A1 PLCH09*4200A1	1.126 [28.60]	PLC24*4200A1 PLCH24*4200A1	2.112 [53.64]
PLC12*4200A1 PLCH12*4200A1	1.324 [33.63]	PLC30*4200A1 PLCH30*4200A1	2.506 [63.65]
PLC18*4200A1 PLCH18*4200A1	1.718 [43.64]		

Plating- See ordering information for contact plating options.
For connection systems 1, 2, 3 and 5.

DIMENSIONS ARE IN INCHES [MILLIMETERS].
ALL DIMENSIONS ARE SUBJECT TO CHANGE.

*Asterisk determines gender of connector, M for male, F for female.



Positronic
connectpositronic.com

RIGHT ANGLE (90°) PRESS-IN CONNECTOR FOR USE WITH "FLAT ROCK" TOOLING

Power
Connection
Systems

PLA RIGHT ANGLE (90°) PRESS-IN CONNECTOR

CODE 62 OR CODE 63

For connection systems 1, 2 and 5.

MALE

FEMALE

NEW
DRAWINGS

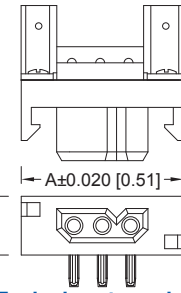
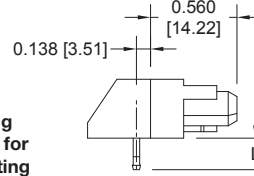
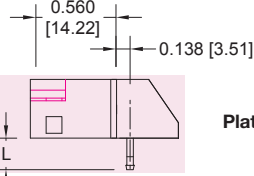
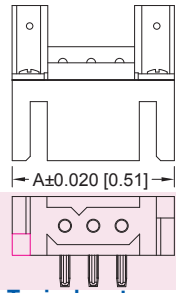

Typical part number:
PLA03M63B30A1
PLAH03M63B30A1

Typical part number:
PLA03F63B30A1
PLAH03F63B30A1

Plating- See ordering
information for
contact plating
options.

PART NUMBER	A	PART NUMBER	A
PLA03**B30A1	1.126 [28.60]	PLA06**B30A1	1.718 [43.64]
PLAH03**B30A1		PLAH06**B30A1	
PLA04**B30A1	1.324 [33.63]	PLA08**B30A1	2.112 [53.64]
PLAH04**B30A1		PLAH08**B30A1	

CONTACT CODE	L	PCB THICKNESS
62	0.183 [4.65]	0.093 [2.36]
63	0.219 [5.56]	0.125 [3.18]

NOTE: Positronic recommends the practice of using mounting hardware to secure connector to printed circuit board. Mounting screws are ordered separately by part number. See page 59.

**Asterisk determines gender of connector, M for male, F for female, and contact code 62 or 63.

PLB RIGHT ANGLE (90°) PRESS-IN CONNECTOR

CODE 62 OR CODE 63

For connection systems 1, 2 and 5.

MALE

FEMALE

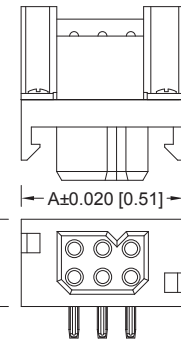
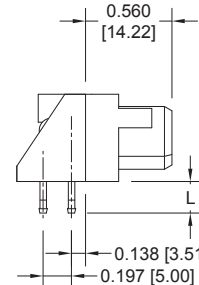
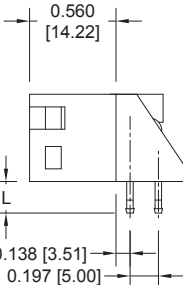
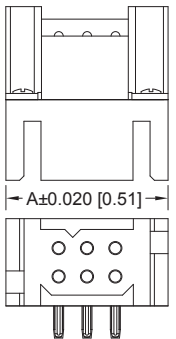

Typical part number:
PLB06M63B30A1
PLBH06M63B30A1

Typical part number:
PLB06F63B30A1
PLBH06F63B30A1

Plating- See ordering
information for
contact plating
options.

PART NUMBER	A	PART NUMBER	A
PLB06**B30A1	1.126 [28.60]	PLB12**B30A1	1.718 [43.64]
PLBH06**B30A1		PLBH12**B30A1	
PLB08**B30A1	1.324 [33.63]	PLB16**B30A1	2.112 [53.64]
PLBH08**B30A1		PLBH16**B30A1	

CONTACT CODE	L	PCB THICKNESS
62	0.183 [4.65]	0.093 [2.36]
63	0.219 [5.56]	0.125 [3.18]

NOTE: Positronic recommends the practice of using mounting hardware to secure connector to printed circuit board. Mounting screws are ordered separately by part number. See page 59.

**Asterisk determines gender of connector, M for male, F for female, and contact code 62 or 63.

PLC RIGHT ANGLE (90°) PRESS-IN CONNECTOR

CODE 62 OR CODE 63

For connection systems 1, 2 and 5.

MALE

FEMALE

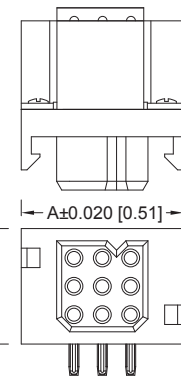
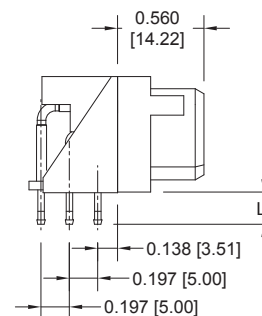
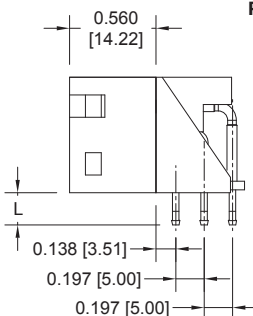
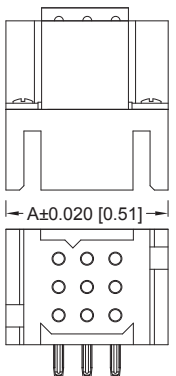

Typical part number:
PLC09M63B30A1
PLCH09M63B30A1

Typical part number:
PLC09F63B30A1
PLCH09F63B30A1

Plating- See ordering
information for
contact plating
options.

PART NUMBER	A	PART NUMBER	A
PLC09**B30A1	1.126 [28.60]	PLC24**B30A1	2.112 [53.64]
PLCH09**B30A1		PLCH24**B30A1	
PLC12**B30A1	1.324 [33.63]	PLC30**B30A1	2.506 [63.65]
PLCH12**B30A1		PLCH30**B30A1	
PLC18**B30A1	1.718 [43.64]		
PLCH18**B30A1			

CONTACT CODE	L	PCB THICKNESS
62	0.183 [4.65]	0.093 [2.36]
63	0.219 [5.56]	0.125 [3.18]

NOTE: Positronic recommends the practice of using mounting hardware to secure connector to printed circuit board. Mounting screws are ordered separately by part number. See page 59.

**Asterisk determines gender of connector, M for male, F for female, and contact code 62 or 63.

PSS SERIES

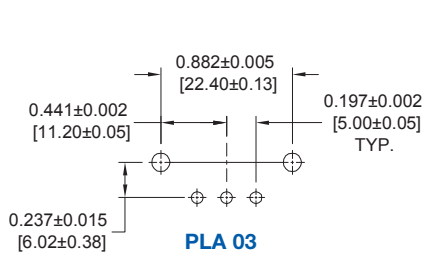

PLA 03

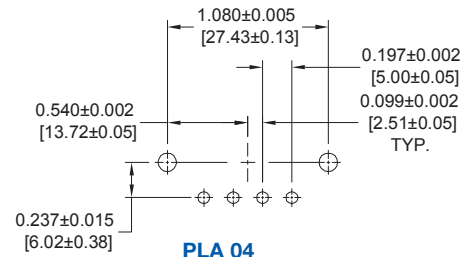

PLA 04

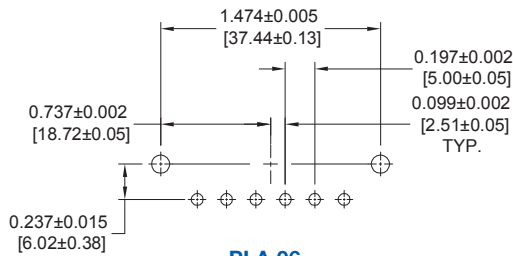

PLA 06

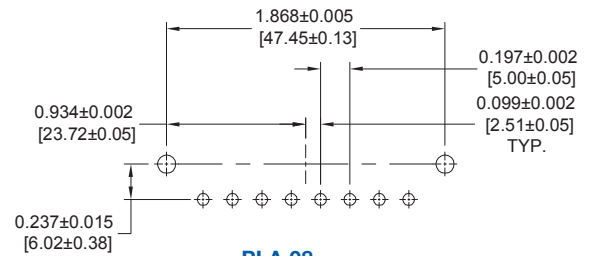

PLA 08

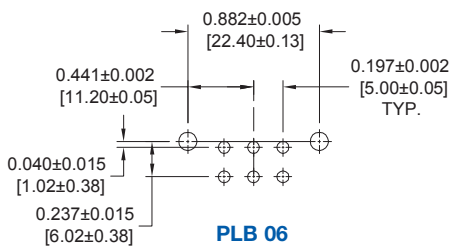

PLB 06

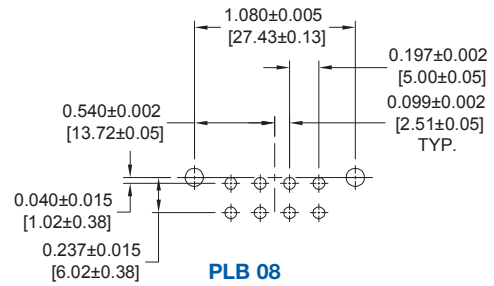

PLB 08

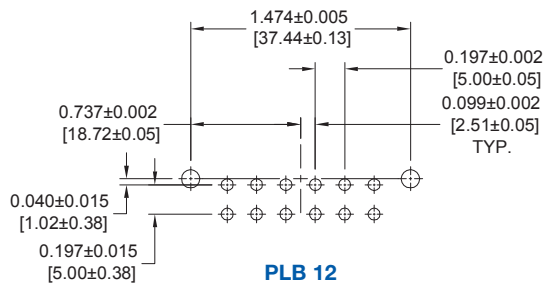

PLB 12

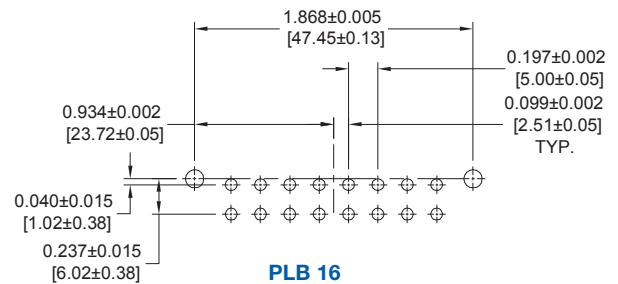

PLB 16

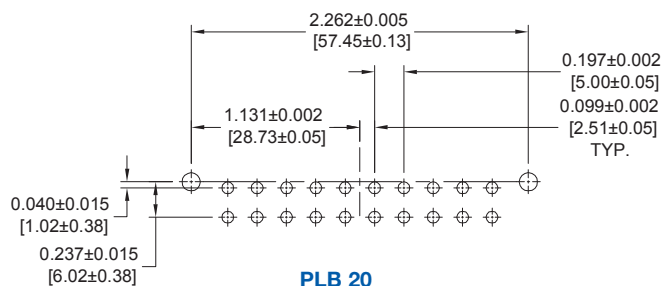

PLB 20

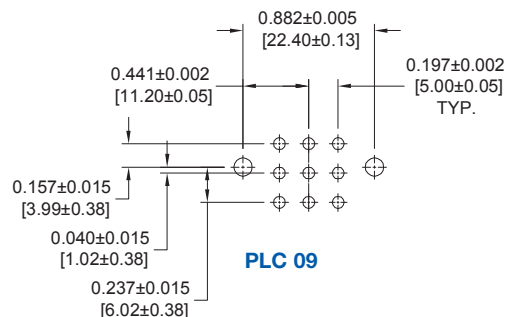

PLC 09

See page 20 for suggested printed board hole sizes.

DIMENSIONS ARE IN INCHES [MILLIMETERS].
ALL DIMENSIONS ARE SUBJECT TO CHANGE.



Positronic
connectpositronic.com

RIGHT ANGLE (90°) PRINTED BOARD CONTACT HOLE PATTERN AND PANEL MOUNT CONNECTOR WITH SOLDER CUP CONTACTS

Power
Connection
Systems

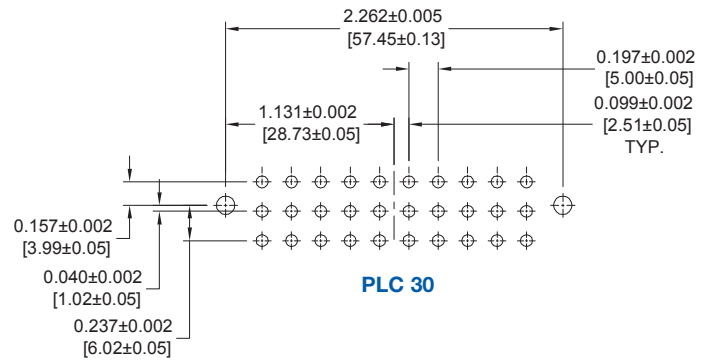
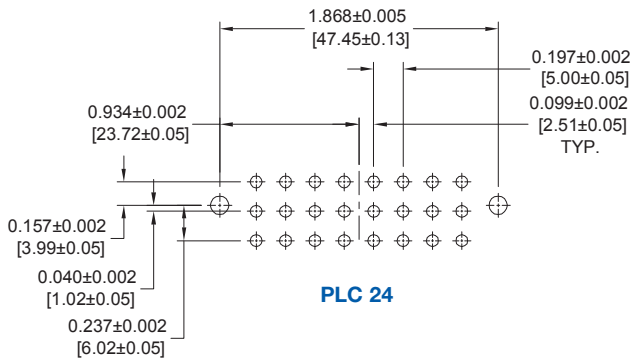
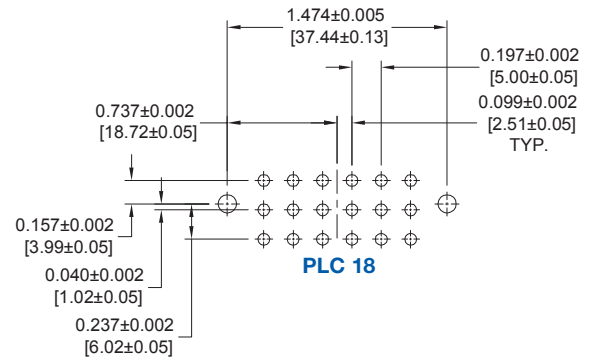
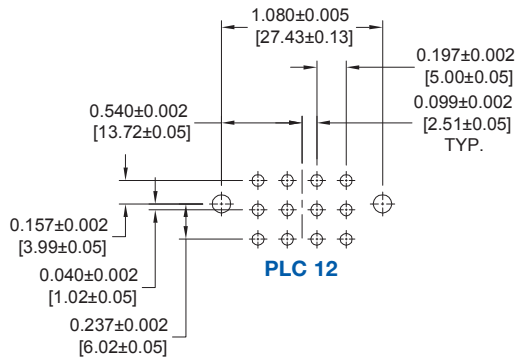

SUGGESTED PRINTED BOARD HOLE SIZES:

Suggest 0.080 [2.03] Ø holes in printed board for solder contact termination positions.

Suggest 0.123±0.003 [3.15±0.08] Ø holes in printed board when mounting connector with push-on fasteners.

NOTE: See page 57 for suggested printed board drill hole sizes, recommended plating and finished hole sizes for compliant contact termination positions.

PANEL MOUNT CONNECTORS WITH SOLDER CUP CONTACTS

CODE 2, 18 AWG [1.00mm²] MAX.

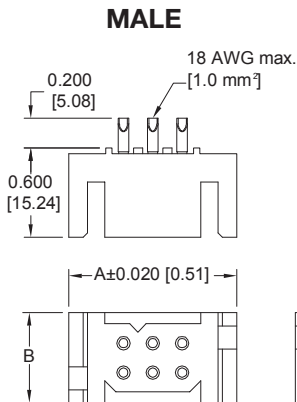

For connection system 8.

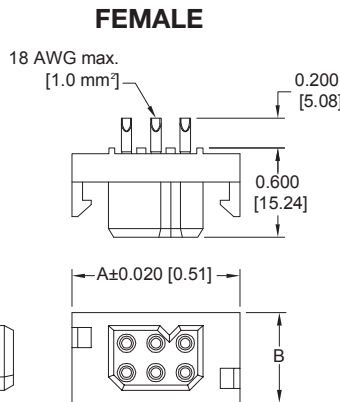

TYPICAL PART NUMBER:
PLB06M200A1

TYPICAL PART NUMBER:
PLB06F200A1

NOTE: MOUNTING SCREWS CAN BE SUPPLIED WITH CONNECTORS USING STEP 5 IN ORDERING INFORMATION ON PAGE 26. MOUNTING SCREWS CAN ALSO BE ORDERED SEPARATELY BY PART NUMBER. SEE PAGE 59.

CONNECTOR VARIANTS	A	B
PLA03	1.126 [28.60]	0.408 [10.36]
PLA04	1.324 [33.63]	0.408 [10.36]
PLA06	1.718 [43.64]	0.408 [10.36]
PLA08	2.112 [53.64]	0.408 [10.36]
PLB06	1.126 [28.60]	0.606 [15.39]
PLB08	1.324 [33.63]	0.606 [15.39]
PLB12	1.718 [43.64]	0.606 [15.39]
PLB16	2.112 [53.64]	0.606 [15.39]
PLB20	2.506 [63.65]	0.606 [15.39]
PLC09	1.126 [28.60]	0.802 [30.37]
PLC12	1.324 [33.63]	0.802 [30.37]
PLC18	1.718 [43.64]	0.802 [30.37]
PLC24	2.112 [53.64]	0.802 [30.37]
PLC30	2.506 [63.65]	0.802 [30.37]

MALE INSULATOR DIMENSIONS FOR CABLE CONNECTORS WITH SIZE 16 REMOVABLE CONTACTS

CODE 0 OR CODE 7

CONTACTS ARE NOT SUPPLIED WITH CONNECTOR AND MUST BE ORDERED SEPARATELY

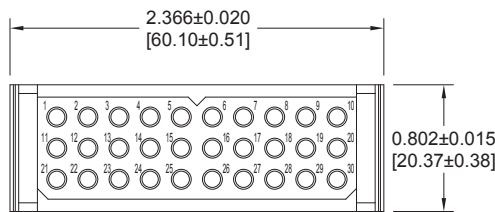
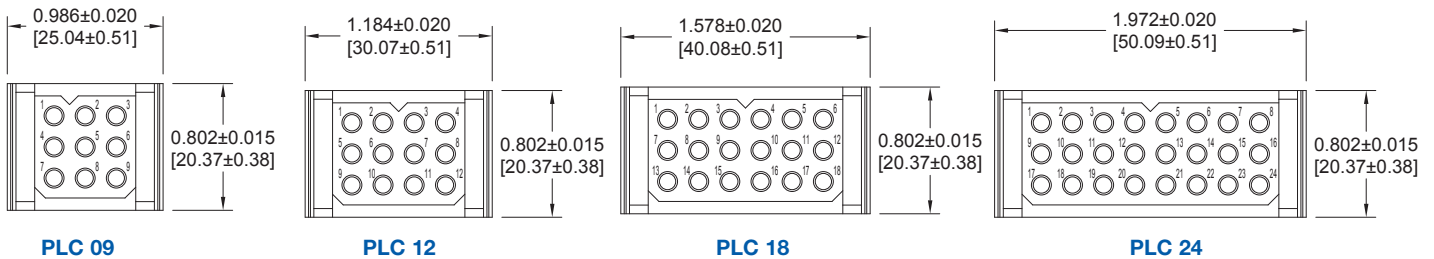
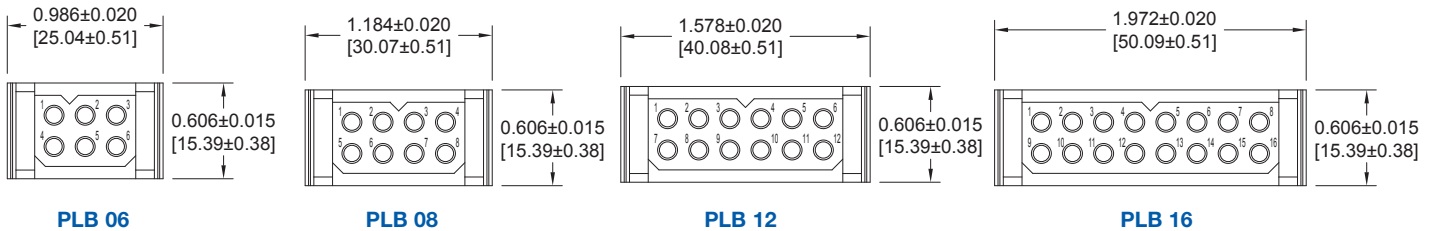
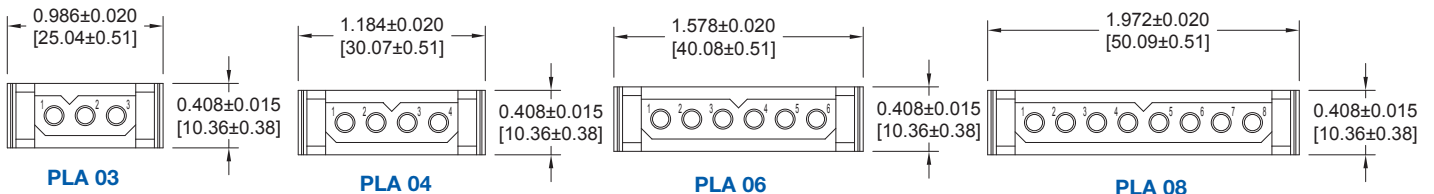
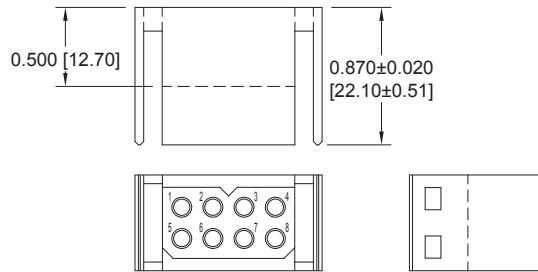

PLC 30

*For information regarding
size 16 removable contacts,
see Removable Contact section,
pages 47-53.*



FEMALE INSULATOR DIMENSIONS FOR CABLE CONNECTORS WITH SIZE 16 REMOVABLE CONTACTS

CODE 0 OR CODE 7

CONTACTS ARE NOT SUPPLIED WITH CONNECTOR AND MUST BE ORDERED SEPARATELY

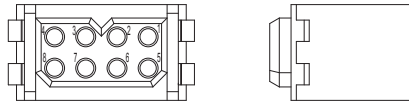
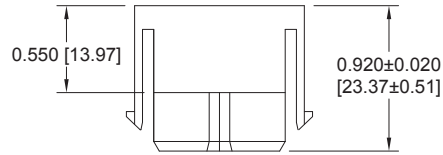

PCS SERIES

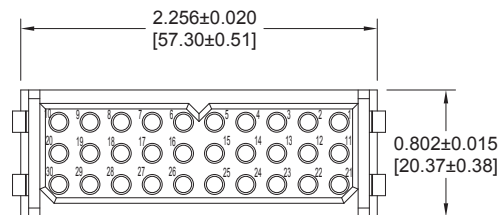
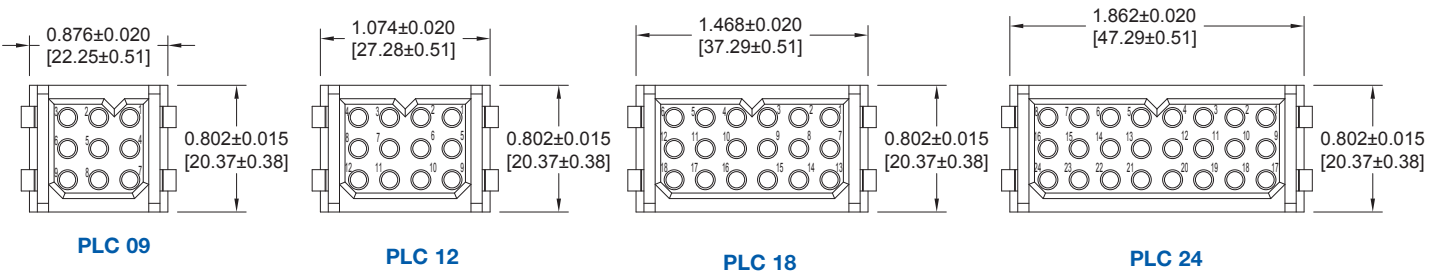
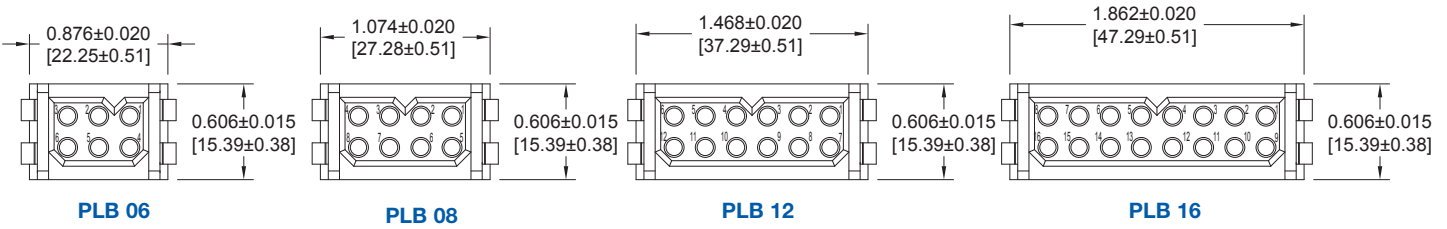
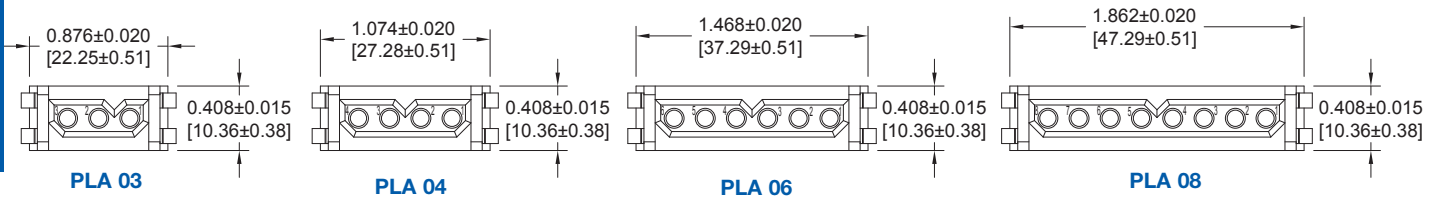

*For information regarding
size 16 removable contacts,
see Removable Contact section,
pages 47-53.*

MALE INSULATOR DIMENSIONS FOR PANEL MOUNT CONNECTORS WITH SIZE 16 REMOVABLE CONTACTS CODE 1 OR CODE 8 CONTACTS ARE NOT SUPPLIED WITH CONNECTOR AND MUST BE ORDERED SEPARATELY

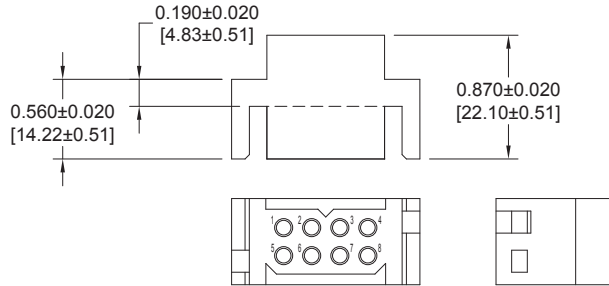

NOTE: MOUNTING SCREWS CAN BE SUPPLIED WITH CONNECTORS USING STEP 5 IN ORDERING INFORMATION ON PAGE 26. MOUNTING SCREWS CAN ALSO BE ORDERED SEPARATELY BY PART NUMBER. SEE PAGE 59.

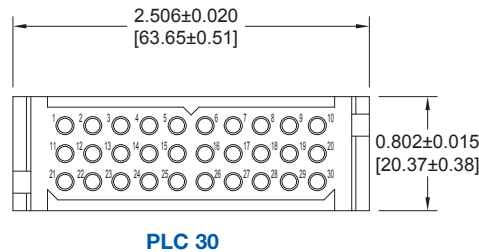
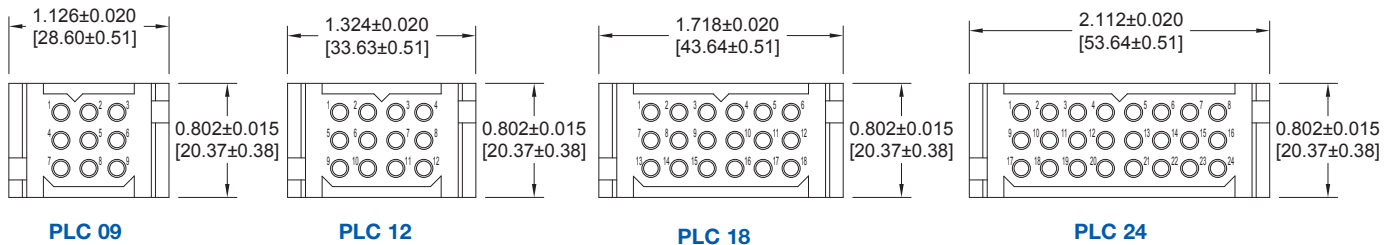
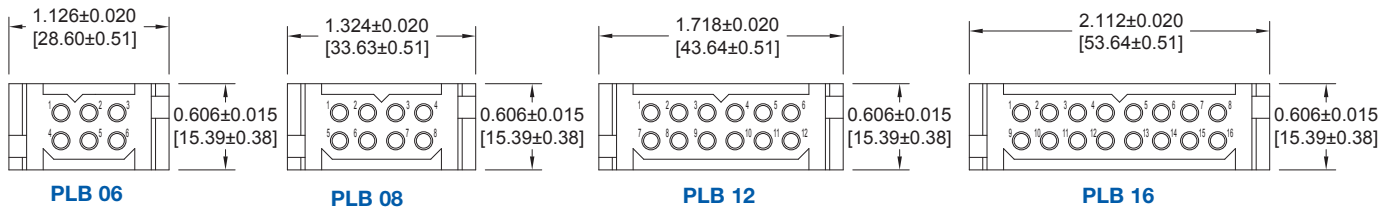
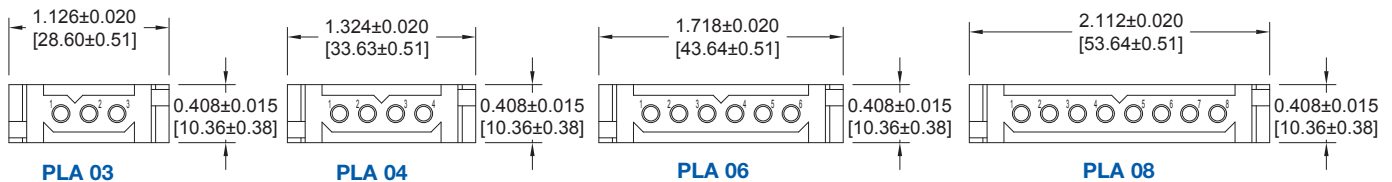

For information regarding panel cutouts, see page 63.

For information regarding size 16 removable contacts, see Removable Contact section, pages 47-53.

PCS SERIES



FEMALE INSULATOR DIMENSIONS FOR PANEL MOUNT CONNECTORS WITH SIZE 16 REMOVABLE CONTACTS

CODE 1 OR CODE 8

CONTACTS ARE NOT SUPPLIED WITH CONNECTOR AND MUST BE ORDERED SEPARATELY

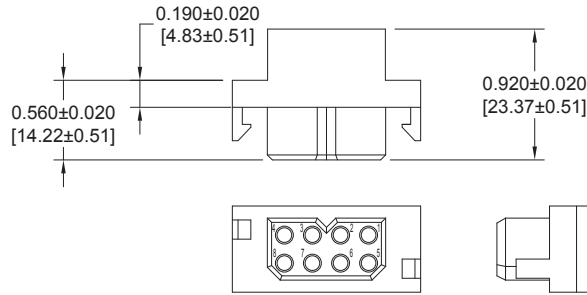

NOTE: MOUNTING SCREWS CAN BE SUPPLIED WITH CONNECTORS USING STEP 5 IN ORDERING INFORMATION ON PAGE 26. MOUNTING SCREWS CAN ALSO BE ORDERED SEPARATELY BY PART NUMBER. SEE PAGE 59.

PCS SERIES

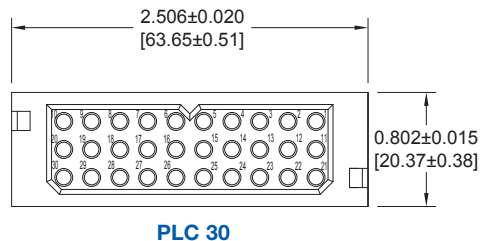
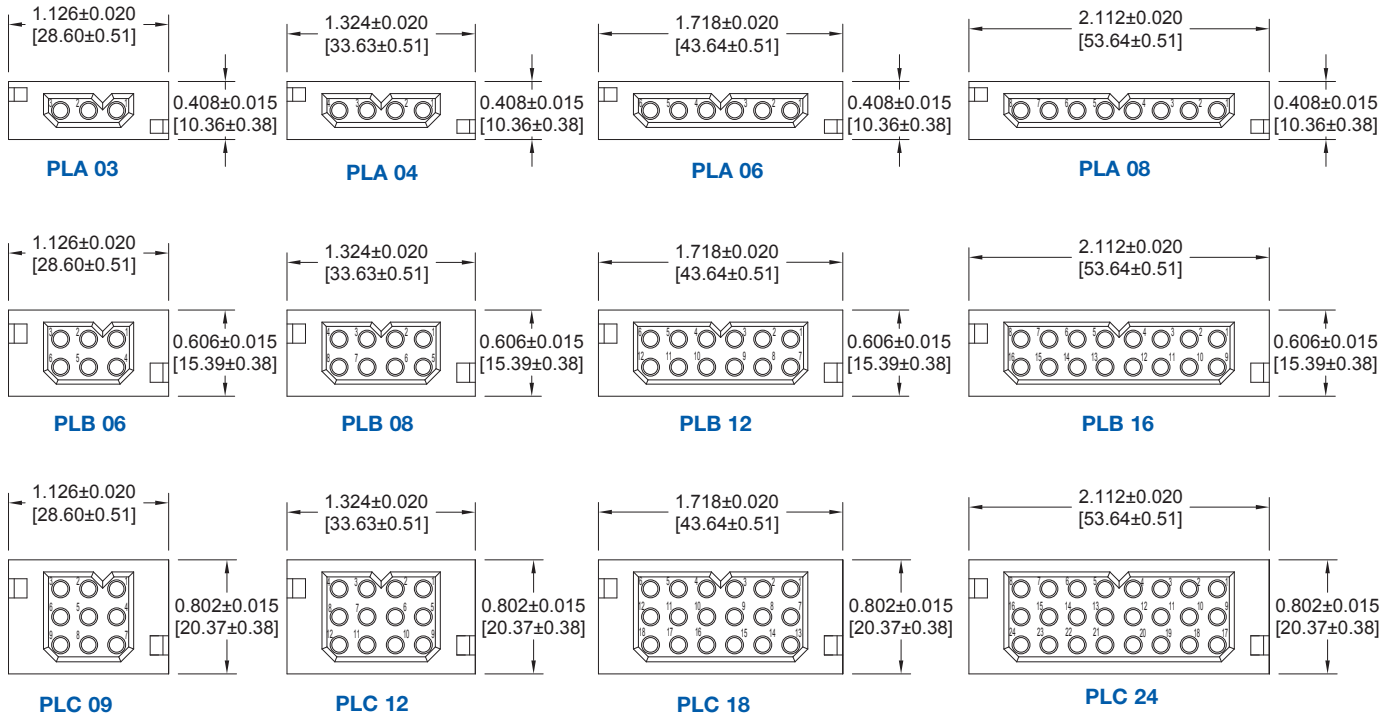

For information regarding panel cutouts, see page 63.

For information regarding size 16 removable contacts, see Removable Contact section, pages 47-53.

SEQUENTIAL MATING SYSTEM

*REMOVABLE CONTACTS FOR CABLE CONNECTORS MUST BE ORDERED SEPARATELY
FOR CONTACT SELECTION, SEE SIZE 16 CONTACTS ON PAGE 49

EXAMPLE 1

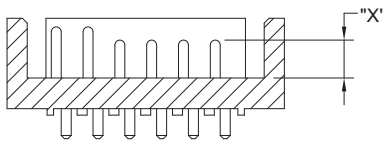
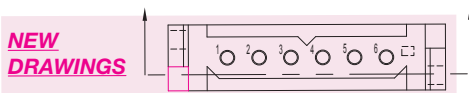

Typical Part Number:
PLA06M300A1-E1B2B

LENGTH CODE	"X" CONTACT LENGTH
A	0.370 [9.40]
B	0.330 [8.38]
C	0.310 [7.87]
D	0.290 [7.37]
E	0.250 [6.35]

MATING CONNECTOR TYPE	CONTACT OPTIONS
Board to Board	B, D, E
Board to Cable*	A, C, E
Cable to Cable*	A, D

EXAMPLE 2

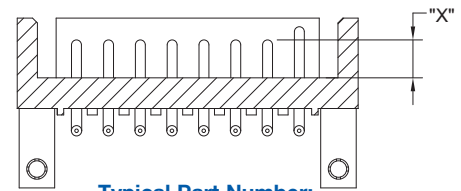
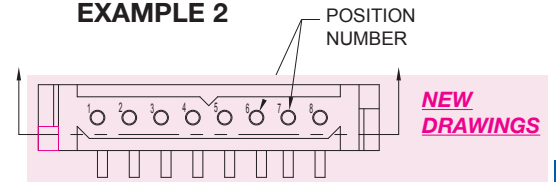

Typical Part Number:
PLA08M4B0C1-D8B

SEQUENTIAL MATING SYSTEM CRIMP REMOVABLE CONTACT PART NUMBERS

WIRE SIZE AWG/[mm ²]	LENGTH CODE "A"	LENGTH CODE "C"	LENGTH CODE "D"	LENGTH CODE "E"
12 - 14 [4.0 - 2.5]	MC112N-133.3	MC112N-133.2	MC112N-133.1	MC112N-133.0
16 - 18 - 20 [1.5 - 1.0 - 0.5]	MC116N-133.3	MC116N-133.2	MC116N-133.1	MC116N-133.0

*For information regarding
size 16 removable contacts,
see Removable Contact section,
pages 47-53.*

SELECTION GUIDE FOR ORDERING DIFFERENT CONTACT LENGTHS

STEP 9 OF ORDERING INFORMATION

SELECT CONNECTOR USING ORDERING INFORMATION ON PAGE 26
THEN CHOOSE STEPS BELOW FOR SEQUENTIAL MATING SYSTEM CONTACTS

STEP	1	2	3	4	5	6	7	8	9
EXAMPLE	E	1	B	2	B	3	D	4	D

STEP 1

Specify code for most frequently used contact mating length. This length is used for all contacts not specified in steps 2 through 9.

STEP 2

Position number for first special length contact.

STEP 3

Length of contact specified in step 2. (Choose from length code chart)

STEP 4

Position number for second special length contact.

STEP 9

Length of contact specified in step 8 (Choose from length code chart).

STEP 8

Position number for fourth special length contact.

STEP 7

Length of contact specified in step 6 (Choose from length code chart).

STEP 6

Position number for third special length contact.

STEP 5

Length of contact specified in step 4 (Choose from length code chart).



Positronic
connectpositronic.com

PCS SERIES CONNECTOR ORDERING INFORMATION

Power
Connection
Systems

ORDERING INFORMATION - CODE NUMBERING SYSTEM

Specify Complete Connector By Selecting An Option From Step 1 Through 7

STEP	1	2	3	4	5	6	7	8	9
EXAMPLE	PLB	06	F	3	0	0	A1	/AA	—

STEP 1 - BASIC SERIES

- PLA - 1 Row
- PLAH - 1 Row High conductivity contacts
- PLB - 2 Row
- PLBH - 2 Row High conductivity contacts
- PLC - 3 Row
- PLCH - 3 Row High conductivity contacts

STEP 2 - CONNECTOR VARIANTS

- 1 Row - 03, 04, 06, 08
- 2 Row - 06, 08, 12, 16, *20
- 3 Row - 09, 12, 18, 24, 30

STEP 3 - CONNECTOR GENDER

- M - Male
- F - Female

STEP 4 - CONTACT TERMINATION TYPE

- *0 - Order contacts separately for cable connectors for connection systems 5, 6, 7, 8 and 9, see pages 47-53.
- *1 - Removable contact, panel mounted connector for connection system 8. Order contacts separately, see pages 47-53.
- 2 - Solder cup, 18 AWG [1.0mm²] max. for panel mount connector, for connection system 8. Not available as PL*H.
- 3 - Solder, Straight Printed Board Mount with 0.146 [3.71] tail extension for connection systems 1, 4 and 6.
- 32 - Solder, Straight Printed Board Mount with 0.377 [9.58] tail extension for connection system 3 and systems 1, 4 and 6.
- 4 - Solder, Right Angle (90°) Printed Board Mount with 0.146 [3.71] tail extension for connection systems 1, 2 and 5.
- 42 - Solder, Right Angle (90°) Printed Board Mount with 0.377 [9.58] tail extension for connection system 3 and systems 1, 2 and 5.
- 62 - Press-in, compliant termination Right Angle (90°) Printed Board Mount, termination length 0.183 [4.65]. Must select "B3" in step 5.
- 63 - Press-in, compliant termination Right angle (90°) Printed Board Mount, termination length 0.219 [5.56]. Must select "B3" in step 5.
- *17 - Order contacts separately for cable connectors for connection systems 5, 6, 7, 8 and 9, see pages 47-53. Terminating side of insulator has 0.165 [4.19] ø c'bore for large wire sizes.
- *18 - Removable contact, panel mounted connector for connection system 8. Order contacts separately, see pages 47-53. Terminating side of insulator has 0.165 [4.19] ø c'bore for large wire sizes.
- 92 - Straight printed board mount, press-in, length 0.183 [4.65] for 0.093 inch [2.36] thick board.
- 93 - Straight printed board mount, press-in, length 0.218 [5.54] for 0.125 inch [3.18] thick board.

STEP 5 - MOUNTING STYLE

- 0 - None.
- B - Metal Right Angle (90°) Mounting Bracket.
- BN - Metal Right Angle (90°) Mounting Bracket with Push-on Fastener.
- B3 - Plastic Right Angle (90°) Mounting Bracket with Cross Bar.
- B3N - Plastic Right Angle (90°) Mounting Bracket with Cross Bar and Push-on Fastener.
- N - Push-On Fastener For Straight Printed Board Mount Connectors
- *ST2 - Self-tapping steel screws 2-28 x 0.250±0.030 [6.35±0.76] length for 0.093 [2.36] thick board.
- *ST3 - Self-tapping steel screws 2-28 x 0.312±0.030 [7.92±0.76] length for 0.125 [3.18] thick board.
- *ST4 - Self-tapping steel screws 2-28 x 0.375±0.030 [9.53±0.76] length for 0.175 [4.45] thick board.
- *SS2 - Self-tapping stainless steel screws 2-28 x 0.250±0.030 [6.35±0.76] length for 0.093 [2.36] thick board.
- *SS3 - Self-tapping stainless steel screws 2-28 x 0.312±0.030 [7.92±0.76] length for 0.125 [3.18] thick board.
- *SS4 - Self-tapping stainless steel screws 2-28 x 0.375±0.030 [9.53±0.76] length for 0.175 [4.45] thick board.

STEP 9 - SPECIAL OPTIONS

Sequential Mating Systems refer to page 25.
CONTACT TECHNICAL SALES FOR SPECIAL OPTIONS

STEP 8 - ENVIRONMENTAL COMPLIANCE OPTIONS

/AA - RoHS Compliant

NOTE: If compliance to environmental legislation is not required, this step will not be used.
Example: PLB06F300A1

STEP 7 - CONTACT PLATING FOR PRINTED BOARD CONNECTORS

- 0 - Crimp Contacts ordered separately, see pages 47-53.
- A1 - Gold flash over nickel on mating end and termination end.
- A2 - Gold flash over nickel on mating end and 0.00020 inch [5.00µ] tin-lead solder coat on termination end. Not available with code 62, 63, 92 or 93 in step 4.
- C1 - 0.000030 inch [0.76µ] gold over nickel on mating end and termination end.
- C2 - 0.000030 inch [0.76µ] gold over nickel on mating end and 0.00020 inch [5.00µ] tin-lead solder coated termination end. Not available with code 62, 63, 92 or 93 in step 4.
- D1 - 0.000050 inch [1.27µ] gold over nickel on mating end and termination end.
- D2 - 0.000050 inch [1.27µ] gold over nickel on mating end and 0.00020 inch [5.00µ] tin-lead solder coated termination end. Not available with code 62, 63, 92 or 93 in step 4.

STEP 6 - HOODS AND PANEL MOUNT

- 0 - None.
- 5 - Top Opening Hood.
- 6 - Panel Mount, quick release.
- 81 - Panel Mount, fixed for 0.040 [1.02] thick panel.
- 82 - Panel Mount, fixed for 0.060 [1.52] thick panel.
- 83 - Panel Mount, fixed for 0.090 [2.29] thick panel.
- 11 - Blind Mating System for 0.040 [1.02] thick panel.
- 12 - Blind Mating System for 0.060 [1.52] thick panel.
- 13 - Blind Mating System for 0.090 [2.29] thick panel.
- 14 - Blind Mating System for 0.120 [3.05] thick panel.

NOTE: Once you have made a connector selection, contact Technical Sales if you would like to receive a drawing in DXF, PDF format or a 3-D IGES, STEP, or SOLIDWORKS file.

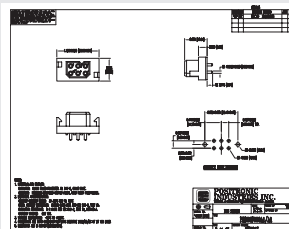

2-D Drawing

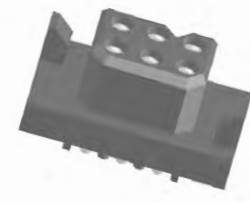

3-D Model

*1 For high conductivity removable contact connectors, order PLA, PLB, or PLC connectors (in Step 1) and *C112N(2)S contacts found on pages 49-51.

*2 PLB20 variant available with code 2, 3, 32, 4, 42, 92, and 93 only in Step 4.

*3 Mounting screws are available with code 1, 2, 3, 32, 8, 92 and 93. To order mounting screws separately, see page 59 for part numbers.

Safety Shrouded Connector to Prevent Unsafe Exposure to High Energy Circuits

- * Size 12 Power Contacts
- * Large Surface Area Mating System
- * Discriminating Locking System
- * Contact Current Rating to
40 Amperes
- *Board - Cable / Cable - Cable



TECHNICAL CHARACTERISTICS

MATERIALS AND FINISHES:

Insulator:	Glass-filled polyester, UL 94V-0. Contact technical sales for availability of high temperature insulator material.
Contacts:	Precision machined copper alloy with gold flash over nickel, or 0.000030 inch [0.76 μ] gold over nickel, or 0.000050 [1.27 μ] gold over nickel. Solder coated terminations optional.
Push-on Fastener:	Spring tempered copper alloy, tin plate.

ELECTRICAL CHARACTERISTICS:

Contact Current Rating:	40 amperes continuous, derated per IEC 60512-3, test 5b. Higher currents available with high conductivity contacts, contact Technical Sales
Initial Contact Resistance:	0.001 ohms max. per IEC 60512-2, test 2b.
Insulation Resistance:	5 G ohms per IEC 60512-2, test 3a.
Voltage Proof:	3,000 minimum V r.m.s. per IEC 60512-2, test 4a, method A.
Clearance and Creepage Distance:	0.220 [5.60] minimum
Working Voltage:	600 minimum V. r.m.s.
Hot Pluggable [50 couplings per UL 1977 paragraph 15]:	250 VAC at 20 amperes
Working Temperature:	-55°C to +125°C Contact technical sales for availability of high temperature insulator material.

MECHANICAL CHARACTERISTICS:

Removable Contacts:	Rear insertion/ front release. Female contact features "Closed Entry" design for highest reliability. 0.094 [2.39] diameter male contact.
Removable Contact Retention in Insulator:	15 lbs. [67N] per IEC 60512-8, test 15a.
Fixed Contacts:	Printed board terminations, both straight and 90°. Female contact features "Closed Entry" design for highest reliability. 0.094 [2.39] diameter male contact.
Fixed Contact Retention in Insulator:	15 lbs. [67N], minimum.
Resistance to Soldering Iron Heat:	500°F [260°C] for 10 seconds duration per IEC 60512-6, test 12e, 25 watt soldering iron.
Contact Terminations:	Crimp removable contacts for wire size 12 AWG [4.0 mm ²]. Straight and right angle (90°) solder printed board mount, 0.090 [2.29] tail diameter.
Connection Systems:	Cable to cable, cable to printed board and cable to panel mount.
Locking System:	Insulators provide locking between cable to cable, cable to printed board and cable to panel mount applications.
Polarization:	Provided in insulator design.
Mounting to P.C. Board:	Rapid installation push-on fasteners.
Mechanical Operations:	500 operations



CONNECTION SYSTEMS

System 5
Cable to Right
Angle (90°) Board
Mount

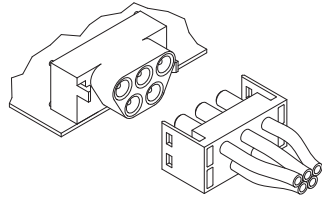

System 6
Cable to Straight
Board Mount

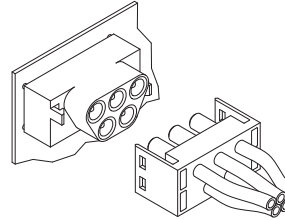

System 7
Cable to Cable

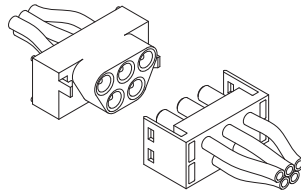

System 8
Panel Mounting
to Cable

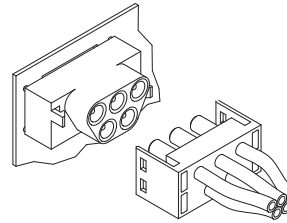

CONNECTOR VARIANTS

FACE VIEW OF MALE OR REAR VIEW OF FEMALE CONNECTOR

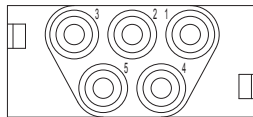

PLS5W5

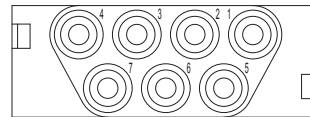

PLS7W7

FEMALE CABLE CONNECTOR FOR CABLE CONNECTORS WITH SIZE 12 REMOVABLE CONTACTS CODE 0

CONTACTS ARE NOT SUPPLIED WITH CONNECTOR AND MUST BE ORDERED SEPARATELY

PART NUMBER	A
PLS5W5F0000	1.655 [42.04]
PLS7W7F0000	2.072 [52.64]

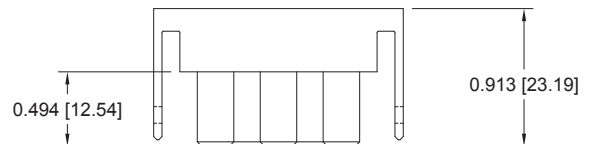

Typical part number:
PLS5W5F00000

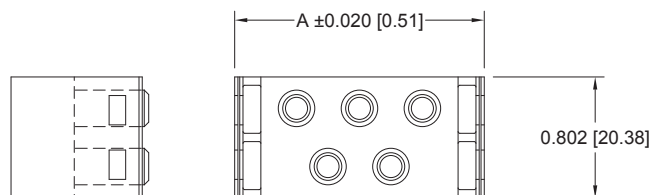

For information regarding size 12 removable contacts, see Removable Contact section, pages 47-53.

**MALE PANEL MOUNT CONNECTOR
FOR PANEL MOUNT CONNECTORS WITH SIZE 12 REMOVABLE CONTACTS
CODE 1**

CONTACTS ARE NOT SUPPLIED WITH CONNECTOR AND MUST BE ORDERED SEPARATELY

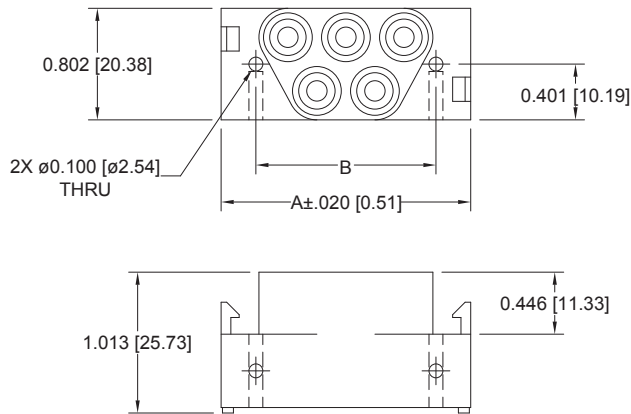

Typical part number:
PLS5W5M10000

PART NUMBER	A	B
PLS5W5M10000	1.795 [45.60]	1.295 [32.90]
PLS7W7M10000	2.213 [56.20]	1.713 [43.50]

**FEMALE PANEL MOUNT CONNECTOR
FOR PANEL MOUNT CONNECTORS WITH SIZE 12 REMOVABLE CONTACTS
CODE 1**

CONTACTS ARE NOT SUPPLIED WITH CONNECTOR AND MUST BE ORDERED SEPARATELY

Typical part number:
PLS5W5F10000

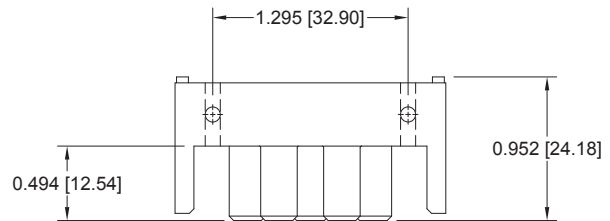

*CONTACT TECHNICAL SALES
FOR AVAILABILITY OF 7W7 VARIANT.

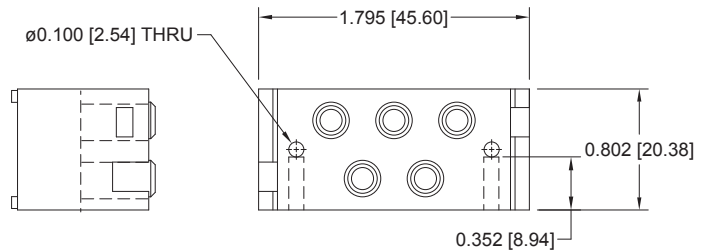

For information regarding size 12 removable contacts, see Removable Contact section, pages 47-53.



STRAIGHT SOLDER AND RIGHT ANGLE (90°) SOLDER PRINTED BOARD CONNECTOR

MALE STRAIGHT PRINTED BOARD MOUNT CONNECTOR CODE 3, 0.146 [3.71] CONTACT EXTENSION

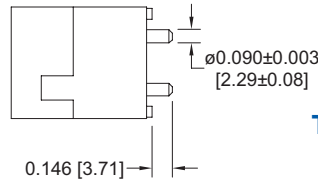
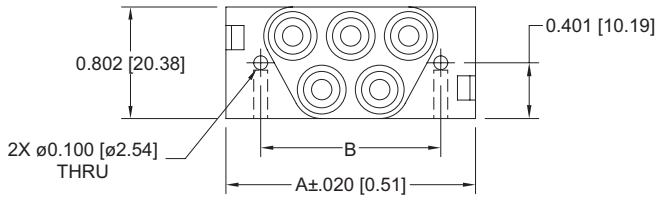

Typical part number:
PLS5W5M300A1

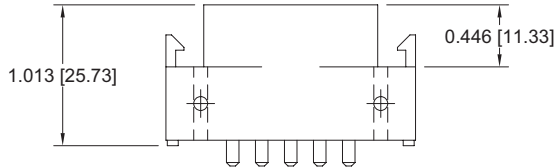

PART NUMBER	A	B
PLS5W5M300A1	1.795 [45.60]	1.295 [32.90]
PLS7W7M300A1	2.213 [56.20]	1.713 [43.50]

MALE RIGHT ANGLE (90°) PRINTED BOARD MOUNT CONNECTOR CODE 4, 0.146 [3.71] CONTACT EXTENSION

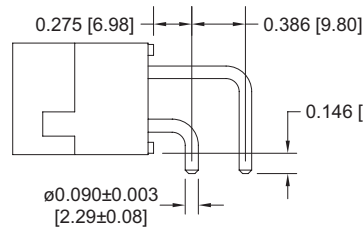
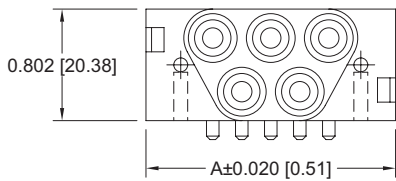

Typical part number:
PLS5W5M400A1

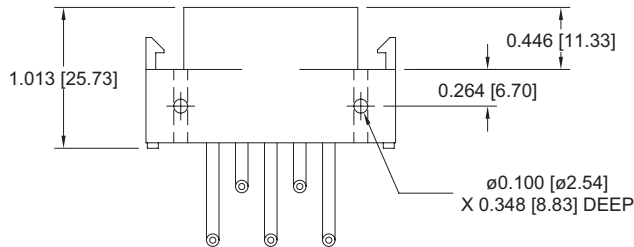

PART NUMBER	A	B
PLS5W5M400A1	1.795 [45.60]	1.295 [32.90]
PLS7W7M400A1	2.213 [56.20]	1.713 [43.50]

PRINTED BOARD CONTACT HOLE PATTERNS

STRAIGHT SOLDER

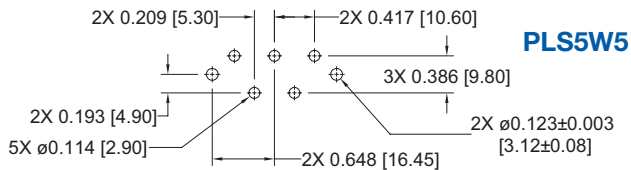

PLS5W5

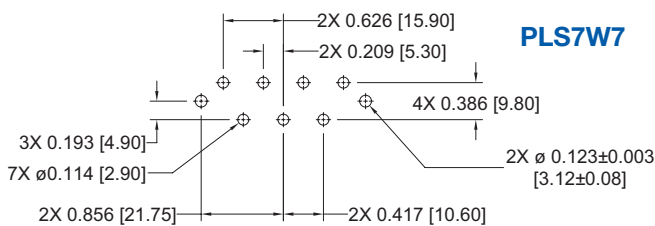

PLS7W7

RIGHT ANGLE (90°)

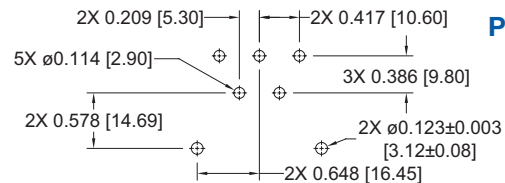

PLS5W5

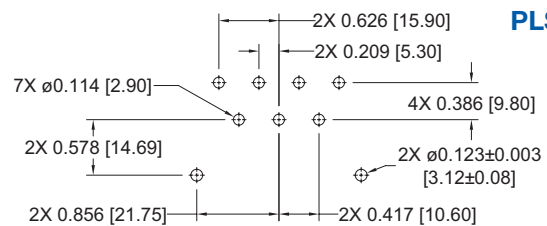

PLS7W7

ORDERING INFORMATION - CODE NUMBERING SYSTEM

Specify Complete Connector By Selecting An Option From Step 1 Through 7

STEP	1	2	3	4	5	6	7	8	9
EXAMPLE	PLS	5W5	M	4	0	0	A1	/AA	—

STEP 1 - BASIC SERIES
 PLS - PLS Series
 PLSH - High conductivity contacts

STEP 2 - CONNECTOR VARIANTS
 5W5 - Five size 12 contacts
 7W7 - Seven size 12 contacts

STEP 3 - CONNECTOR GENDER
 M - Male
 F - Female

STEP 4 - CONTACT TERMINATION TYPE

0 - Order contacts separately for cable connectors for connection systems 5, 6, 7 and 8, see pages 47-53. Female connectors only. **

1 - Order contacts separately for Panel Mount connectors for connection system 7, see pages 47-53. For 7W7 female variant consult technical sales.

3 - Solder, Straight Printed Board Mount with 0.146 [3.71] tail extension for connection system 6. Male connectors only. ***

4 - Solder, Right Angle (90°) Printed Board Mount with 0.146 [3.71] tail extension for connection system 5. Male connectors only. ***

STEP 5 - MOUNTING STYLE

0 - None.

N - Push-on Fastener for Straight Printed Board Mount Connectors

NOTE: Once you have made a connector selection, contact Technical Sales if you would like to receive a drawing in DXF, PDF format or a 3-D IGES, STEP, or SOLIDWORKS file.

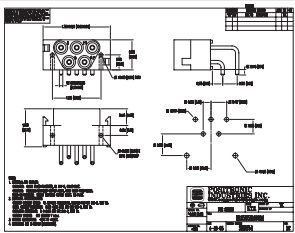

2-D Drawing



3-D Model

STEP 9 - SPECIAL OPTIONS
 CONTACT TECHNICAL SALES FOR SPECIAL OPTIONS

STEP 8 - ENVIRONMENTAL COMPLIANCE OPTIONS
 /AA - RoHS Compliant

NOTE: If compliance to environmental legislation is not required, this step will not be used. Example: PLS5W5M400A1

STEP 7 - CONTACT PLATING FOR PRINTED BOARD CONNECTORS

0 - Crimp Contacts ordered separately, see pages 47-53.

A1 - Gold flash over nickel on mating end and termination end.

A2 - Gold flash over nickel on mating end and 0.00020 inch [5.00µ] tin-lead solder coat on termination end.

C1 - 0.000030 inch [0.76µ] gold over nickel on mating end and termination end.

C2 - 0.000030 inch [0.76µ] gold over nickel on mating end and 0.00020 inch [5.00µ] tin-lead solder coated termination end.

D1 - 0.000050 inch [1.27µ] gold over nickel on mating end and termination end.

D2 - 0.000050 inch [1.27µ] gold over nickel on mating end and 0.00020 inch [5.00µ] tin-lead solder coated termination end.

STEP 6 - CABLE ADAPTER

0 - None

5 - Top Opening Hood, see accessories section page 60.

** Consult technical sales for availability of male version of contact type 0.

*** Consult technical sales for availability of female version of contact type 3 and 4.

SAFETY SHROUD

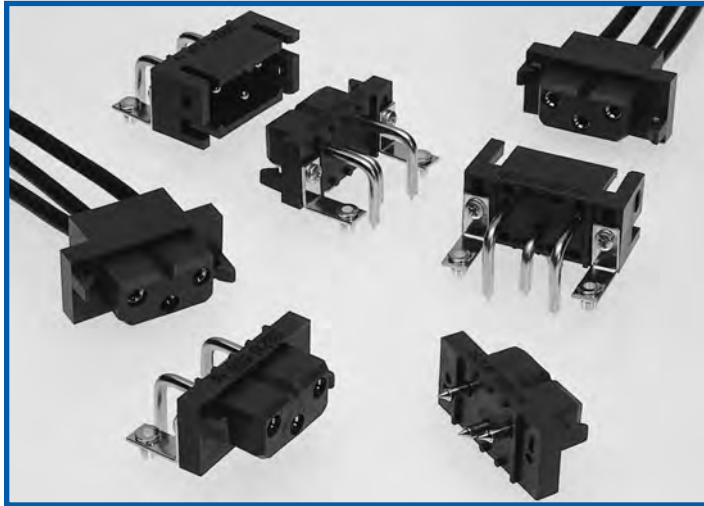

A.C. / D.C. INPUT CONNECTOR

- * Hot Plug Capability
- * Screw Termination Contacts
- * Size 12 Power Contacts
- * Large Surface Area Mating System
- * Contact Current Rating to 40 Amperes
- * Sequential Mating Options
- * Discriminating Locking System

TECHNICAL CHARACTERISTICS

MATERIALS AND FINISHES:

Insulator:	Glass-filled polyester, UL 94V-0. Contact technical sales for availability of high temperature insulator material.
Contacts:	Precision machined copper alloy with gold flash over nickel, or 0.000030 inch [0.76µ] gold over nickel, or 0.000050 [1.27µ] gold over nickel. Solder coated terminations optional.
Hood:	Glass-filled polyester, UL 94V-0.
Mounting Bracket:	Brass, tin plate.
Push-on Fastener:	Spring tempered copper alloy, tin plate.
Mounting Screw:	Steel, zinc plate, or stainless steel passivated.

ELECTRICAL CHARACTERISTICS:

CONTACT CURRENT RATING:

Standard Contact Material:	40 amperes. See page 33 for details.
High Conductivity Contact Material:	55 amperes. See page 33 for details.

INITIAL CONTACT RESISTANCE:

Standard Contact Material:	0.001 ohms max. per IEC 60512-2, test 2b.
High Conductivity Contact Material:	0.00037 ohms max. per IEC 60512-2, test 2b.
Insulation Resistance:	5 G ohms per IEC 60512-2, test 3a.
Voltage Proof:	3,750 V r.m.s. per IEC 60512-2, test 4a, method A.

Clearance and

Creepage Distance:	0.125 [3.18] minimum
Working Voltage:	1,250 V. r.m.s.
Hot Pluggable [50 couplings per UL 1977 paragraph 15]:	Contact technical sales
Working Temperature:	-55°C to +125°C Contact technical sales for availability of high temperature insulator material.

MECHANICAL CHARACTERISTICS:

Removable Contacts:	Rear insertion/ front release. Female contact features "Closed Entry" design for highest reliability. 0.094 [2.39]
Removable Contact Retention in Insulator:	20 lbs. [89N] per IEC 60512-8, test 15a.
Fixed Contacts:	Printed board terminations, both straight and right angle (90°). Female contact features "Closed Entry" design for highest reliability. 0.094 [2.39] diameter male contact.
Fixed Contact Retention in Insulator:	10 lbs. [44N], minimum.
Resistance to Soldering Iron Heat:	260°C [500°F] for 10 seconds duration per IEC 60512-6, test 12e, 25 watt soldering iron.
Contact Terminations:	Crimp removable contacts and solder cup removable contacts for wire size 12 AWG [4.0 mm ²]. Straight and right angle (90°) solder printed board mount, 0.090 [2.29] tail diameter. Compliant termination press-in.
Connection Systems:	Cable to cable, cable to printed board, cable to panel mount, and printed board to printed board.
Sequential Mating Systems:	Male contacts can provide two mating lengths.
Locking System:	Insulators provide locking between cable to cable, cable to printed board, and cable to panel mount applications.
Polarization:	Provided in insulator design.
Mounting to P.C. Board:	Rapid installation push-on fasteners.
Mechanical Operations:	500 operations



CONNECTION SYSTEMS

System 1
Mother Board -
Daughter Board

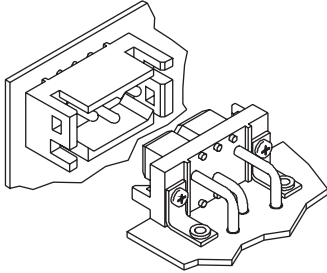

System 2
Side to Side
Board Mounting

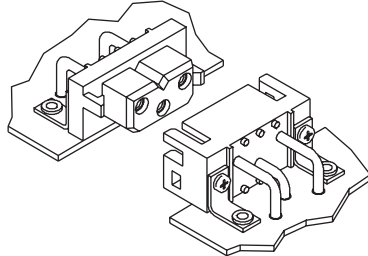

System 4
Sandwich Board
Mounting

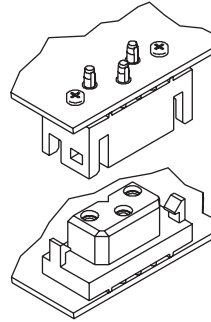

System 5
Cable to Right
Angle (90°)
Board Mount

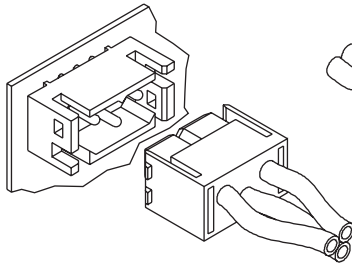
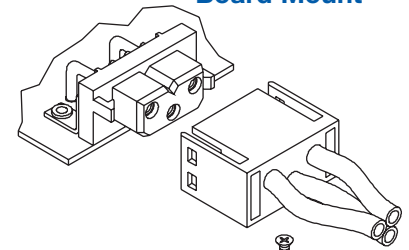

System 6
Cable to Straight
Board Mount

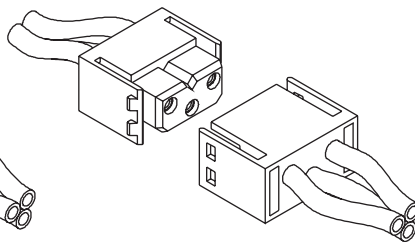

System 7
Cable to Cable

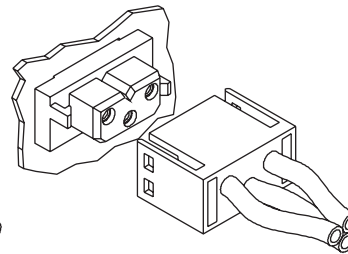

System 8
Panel Mounting
to Cable

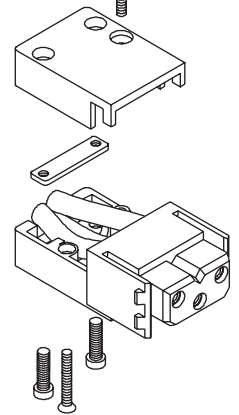

System 9
Cable Connector with
Cable Adapter

TEMPERATURE RISE CURVE

STANDARD CONTACT MATERIALS

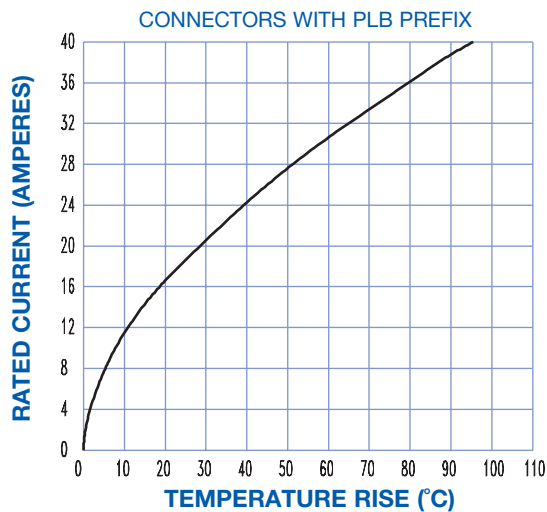

Test conducted per IEC Publication 60512-3, Test 5a.
All power contacts under load.

Standard Density: Curve developed using PLB3W3M4BN0A1 and PLB3W3F300A1 mated connector terminated to 12 AWG wire.

High Conductivity: Curve developed using PLBH3W3M9300A1 and PLBH3W3F9300A1 mated connector terminated to 12 AWG wire

HIGH CONDUCTIVITY CONTACT MATERIALS

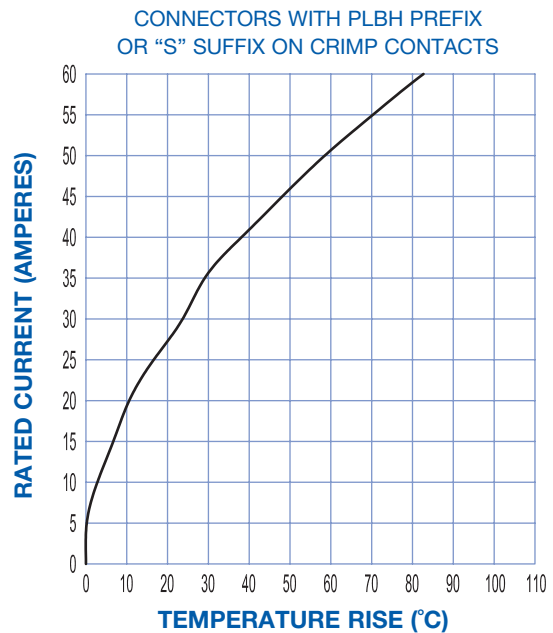

DIMENSIONS ARE IN INCHES [MILLIMETERS].
ALL DIMENSIONS ARE SUBJECT TO CHANGE.



CONNECTOR VARIANT FACE VIEW OF MALE CONNECTOR

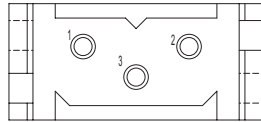

PLB3W3

CABLE CONNECTOR FOR USE WITH SIZE 12 REMOVABLE CONTACTS CODE 0

CONTACTS ARE NOT SUPPLIED WITH CONNECTOR AND MUST BE ORDERED SEPARATELY

MALE

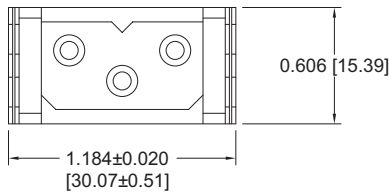

Part Number: PLB3W3M0000

FEMALE

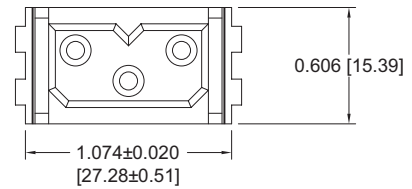

Part Number: PLB3W3F0000

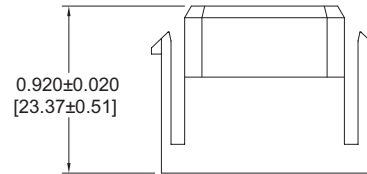
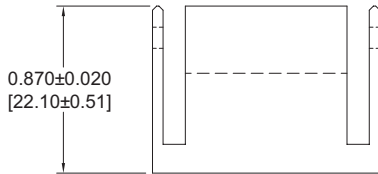

PANEL MOUNT CONNECTOR FOR USE WITH SIZE 12 REMOVABLE CONTACTS CODE 1

CONTACTS ARE NOT SUPPLIED WITH CONNECTOR AND MUST BE ORDERED SEPARATELY

MALE

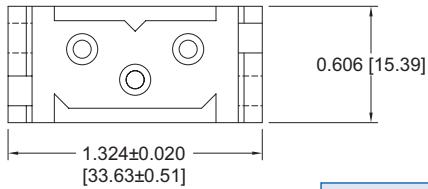

Part Number: PLB3W3M1000

FEMALE

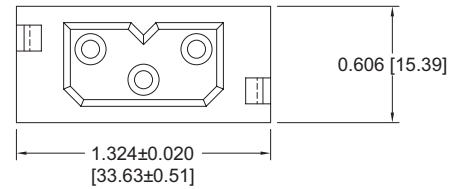

Part Number: PLB3W3F1000

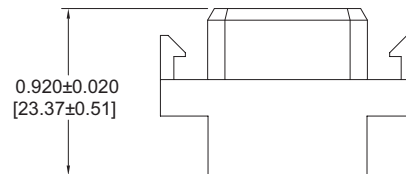
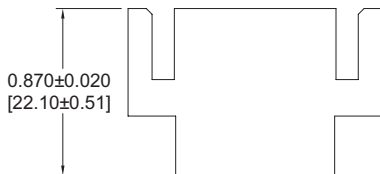

NOTE: MOUNTING SCREWS CAN BE SUPPLIED WITH CONNECTORS USING STEP 5 IN ORDERING INFORMATION ON PAGE 38. MOUNTING SCREWS CAN ALSO BE ORDERED SEPARATELY BY PART NUMBER. SEE PAGE 59.

For information regarding size 12 removable contacts, see Removable Contact section, pages 47-53.

**STRAIGHT PRINTED BOARD MOUNT CONNECTOR
CODE 3, 0.146 [3.71] CONTACT EXTENSION**

NOTE: MOUNTING SCREWS CAN BE SUPPLIED WITH CONNECTORS USING STEP 5 IN ORDERING INFORMATION ON PAGE 38. MOUNTING SCREWS CAN ALSO BE ORDERED SEPARATELY BY PART NUMBER. SEE PAGE 59.

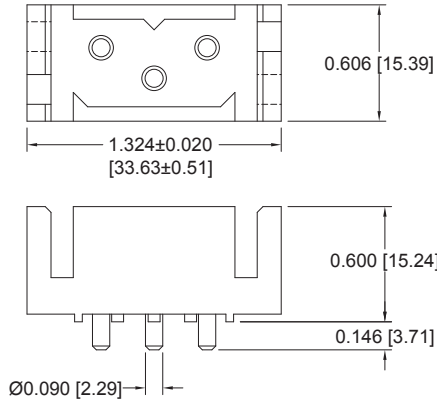

Part Number: PLB3W3M300A1

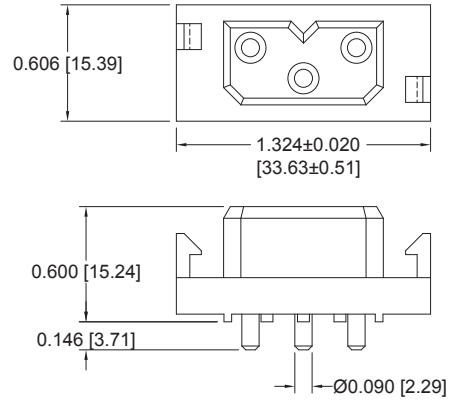

Part Number: PLB3W3F300A1

**COMPLIANT PRESS-IN CONNECTOR
CODE 93, 0.225 [5.72] CONTACT EXTENSION**

NOTE: Positronic recommends the practice of using mounting hardware to secure connector to printed circuit board. Mounting screws can be supplied with connectors using step 5 in ordering information on page 38. Mounting screws can also be ordered separately by part number. See page 59.

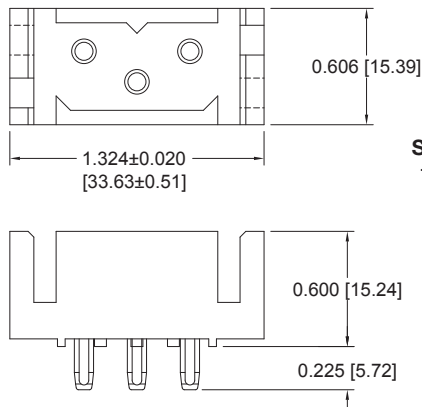

Part Number: PLB3W3M93ST30A1

See page 56-57
for Compliant
Press-in
information.

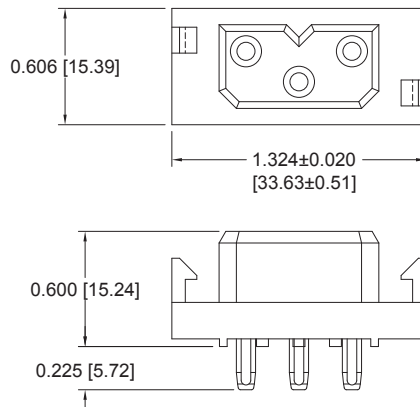

Part Number: PLB3W3F93ST30A1

CONTACT HOLE PATTERN

FOR STRAIGHT PRINTED BOARD MOUNT AND COMPLIANT PRESS-IN CONNECTORS

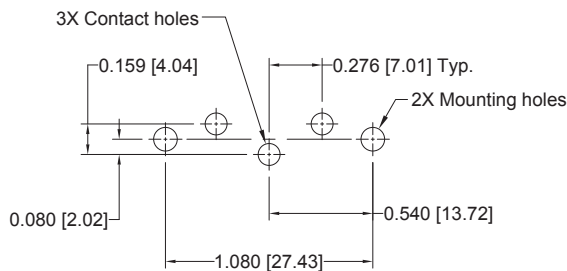

SUGGESTED PRINTED BOARD HOLE SIZES:

Suggest Ø 0.114 [2.90] finished holes in printed board for straight solder printed board mount contacts.

Suggest Ø 0.123±0.003 [3.15±0.08] holes in printed board for mounting connector with push-on fasteners or 0.100 [2.54] for mounting connector with #2 screws.

NOTE: See page 57 for suggested printed board drill hole sizes, recommended plating and finished hole sizes for compliant contact termination positions.



RIGHT ANGLE (90°) PRINTED BOARD MOUNT CONNECTOR CODE 4, 0.146 [3.71] CONTACT EXTENSION

MALE

FEMALE

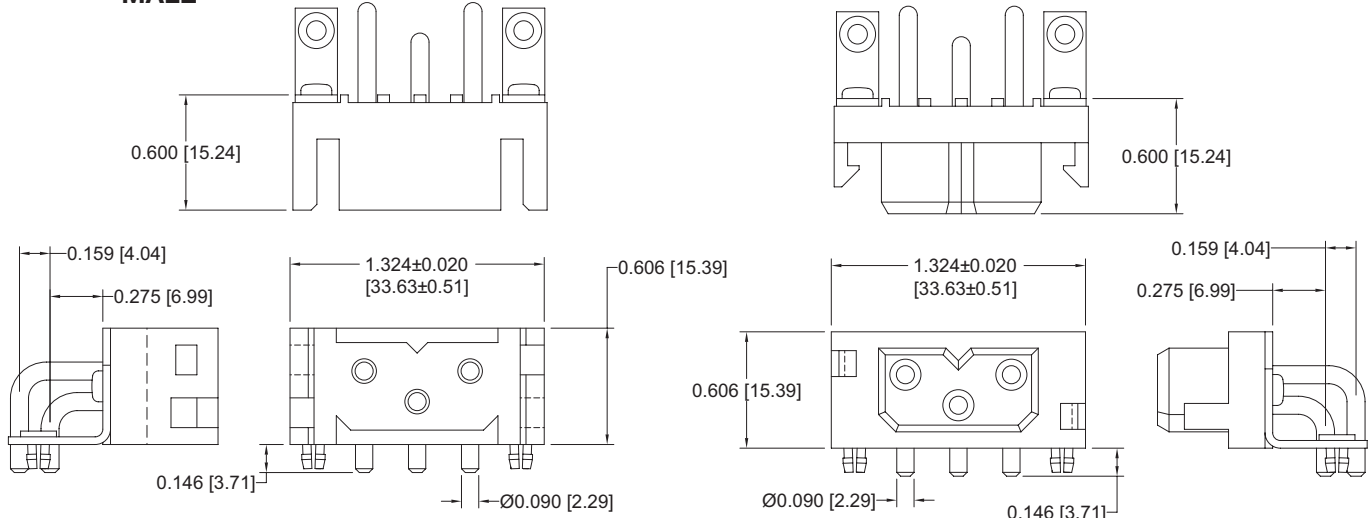

Part Number:
PLB3W3M4BN0A1

Part Number:
PLB3W3F4BN0A1

CONTACT HOLE PATTERN RIGHT ANGLE (90°) ANGLE PRINTED BOARD MOUNT CONNECTORS

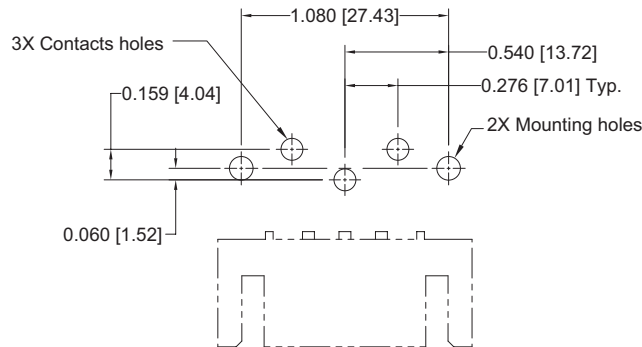

SUGGESTED PRINTED BOARD HOLE SIZES:

Suggest \varnothing 0.114 [2.90] finished holes in printed board for right angle (90°) solder printed board mount contacts.

Suggest \varnothing 0.123±0.003 [3.15±0.08] holes in printed board for mounting connector with push-on fasteners.

SCREW TERMINATION CONNECTOR

SCREW TERMINATIONS ALLOWS FOR CONVENIENT FIELD INSTALLATION WHEN REQUIRED

CODE 71

CONTACTS MAY BE SUPPLIED WITH CONNECTOR OR ORDERED SEPARATELY

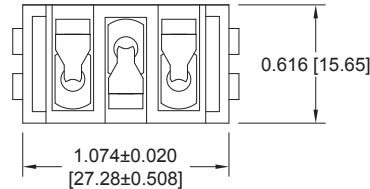
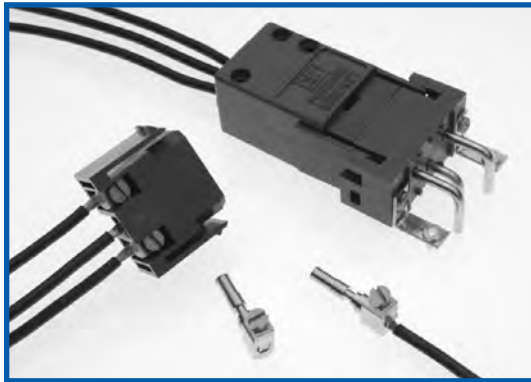

Typical Part Number:
PLB3W3F7100A1
supplied with 3 contacts

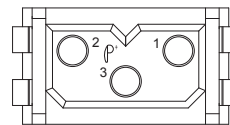
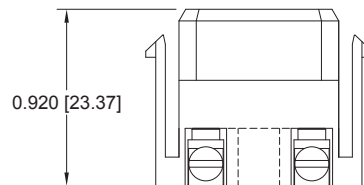

REPLACEMENT CONTACT

For use with wire
size 12 awg [4.0mm²]
or smaller

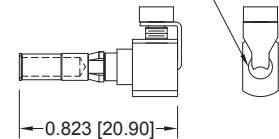

Typical Part Number:
FST612N2

SEQUENTIAL MATING CONTACTS

BOARD MOUNT CONNECTORS

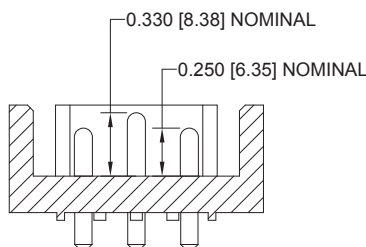

Modification number -338.0 (see step 8 of the ordering information) allows for board mount connector to have position 3 loaded with a 0.330 [8.38] nominal mating length contact and positions 1 and 2 loaded with 0.250 [6.35] nominal mating length contacts. **Contact technical sales for additional sequencing options.**

CRIMP AND PANEL MOUNT CONNECTORS

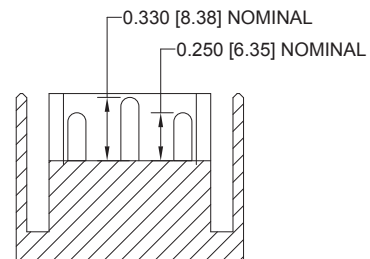

MC610NS and **MC612N** crimp contacts and **MC610NS** and **MC612N** solder cup contacts to be used for 0.330 [8.38] nominal mating length. **MC610NS-228.2** and **MC612N-228.2** crimp contacts and **MS610NS-228.2** and **MS612N-228.2** solder cup contacts to be used for 0.250 [6.35] nominal mating length.



ORDERING INFORMATION - CODE NUMBERING SYSTEM

Specify Complete Connector By Selecting An Option From Step 1 Through 7

STEP	1	2	3	4	5	6	7	8	9
EXAMPLE	PLB	3W3	F	3	0	0	A1	/AA	—

STEP 1 - BASIC SERIES

PLB - PLB Series
PLBH - High conductivity contacts.

STEP 2 - CONNECTOR VARIANTS

3W3 - Three size 12 contacts

STEP 3 - CONNECTOR GENDER

M - Male
F - Female

STEP 9 - SPECIAL OPTIONS

-338.0 - Sequential mating. Position 3 first mate, last break. Available on 3, 4, and 93 only.

CONTACT TECHNICAL SALES FOR SPECIAL OPTIONS

STEP 8 - ENVIRONMENTAL COMPLIANCE OPTIONS

/AA - RoHS Compliant)

NOTE: If compliance to environmental legislation is not required, this step will not be used. Example: PLB3W3F300A1

STEP 4 - CONTACT TERMINATION TYPE

- 0 - Order contacts separately for cable connectors for connection systems 5, 6, 7, 8 and 9, see pages 47-53.
- *1 - Removable contact, panel mount connector for connection system 8. Order contacts separately, see pages 47-53.
- *3 - Solder, Straight Printed Board Mount with 0.146 [3.71] tail extension for connection systems 1, 4, and 6.
- 4 - Solder, Right Angle (90°) Printed Board Mount with 0.146 [3.71] tail extension for connection systems 1, 2 and 5.
- 71 - Screw termination cable connector. Supplied with 3 contacts.
- *93 - Press-in, Compliant Termination for 0.090 [2.29] to 0.175 [4.45] thick P.C. board, for connector systems 1, 4, and 6.

STEP 7 - CONTACT PLATING FOR PRINTED BOARD CONNECTORS

- 0 - Crimp Contacts ordered separately, see pages 47-53.
- A1 - Gold flash over nickel on mating end and termination end.
- A2 - Gold flash over nickel on mating end and 0.00020 inch [5.00µ] tin-lead solder coat on termination end. Not available with contact code 71 or 93.
- C1 - 0.000030 inch [0.76µ] gold over nickel on mating end and termination end.
- C2 - 0.000030 inch [0.76µ] gold over nickel on mating end and 0.00020 inch [5.00µ] tin-lead solder coated termination end. Not available with contact code 71 or 93.
- D1 - 0.000050 inch [1.27µ] gold over nickel on mating end and termination end.
- D2 - 0.000050 inch [1.27µ] gold over nickel on mating end and 0.00020 inch [5.00µ] tin-lead solder coated termination end. Not available with contact code 71 or 93.

STEP 5 - MOUNTING STYLE

- 0 - None
- B - Metal Right Angle (90°) Mounting Bracket.
- BN - Metal Right Angle (90°) Mounting Bracket with Push-on Fastener.
- N - Push-On Fastener For Straight Printed Board Mount Connectors
- ST2 - Self-tapping steel screws 2-28 x 0.250±0.030 [6.35±0.76] length for 0.093 [2.36] thick board.
- ST3 - Self-tapping steel screws 2-28 x 0.312±0.030 [7.92±0.76] length for 0.125 [3.18] thick board.
- ST4 - Self-tapping steel screws 2-28 x 0.375±0.030 [9.53±0.76] length for 0.175 [4.45] thick board.
- SS2 - Self-tapping stainless steel screws 2-28 x 0.250±0.030 [6.35±0.76] length for 0.093 [2.36] thick board.
- SS3 - Self-tapping stainless steel screws 2-28 x 0.312±0.030 [7.92±0.76] length for 0.125 [3.18] thick board.
- SS4 - Self-tapping stainless steel screws 2-28 x 0.375±0.030 [9.53±0.76] length for 0.175 [4.45] thick board.

STEP 6 - CABLE ADAPTER AND BLIND MATE SYSTEM

- 0 - None.
- 5 - Top Opening Hood.
- 11 - Blind Mating System for 0.040 [1.02] thick panel.
- 12 - Blind Mating System for 0.060 [1.52] thick panel.
- 13 - Blind Mating System for 0.090 [2.29] thick panel.
- 14 - Blind Mating System for 0.120 [3.05] thick panel.

*1 Mounting screws are available with code 1, 3 and 93. To order mounting screws separately, see page 59 for part numbers.

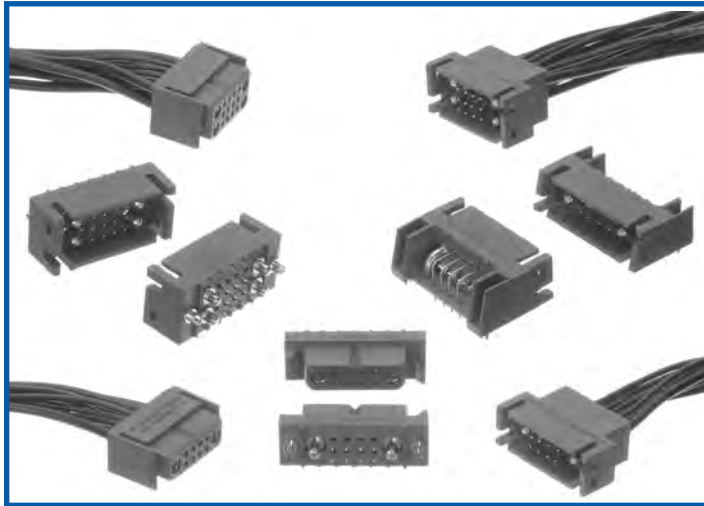

PCS SERIES POWER CONNECTORS WITH MIXED DENSITY CONTACTS

* Mixed density contacts

- Power contacts have a resistance as low as 0.0003 ohms and carry up to 85 amperes per UL 1977
- Available with two power contacts and eight signal; or four power contacts and twelve signal
- Solder, press-in or cable terminations
- Integral locking on cable connectors

TECHNICAL CHARACTERISTICS

MATERIALS AND FINISHES:

Insulator:	Glass-filled polyester, UL 94V-0. Contact technical sales for availability of high temperature insulator material.
Contacts:	Precision machined copper alloy with gold flash over nickel, or 0.000030 inch [0.76 μ] gold over nickel, or 0.000050 [1.27 μ] gold over nickel. Solder coated terminations optional.
Mounting Clip:	Beryllium copper with tin plate.
Hood:	Glass filled polyester, UL 94V-0.
Mounting Bracket:	Brass with tin plate.
Push-on Fastener:	Spring tempered copper alloy, tin plate

ELECTRICAL CHARACTERISTICS:

SIGNAL CONTACTS

Contact Current Rating:	7.5 amperes nominal.
Initial Contact Resistance:	0.007 ohms max. per IEC 60512-2, test 2b

POWER CONTACTS

Contact Current Rating:	See temperature rise curves on page 40. For additional information see pages 47-53.
Initial Contact Resistance:	0.0005 ohms max. per IEC 60512-2, test 2b.
Standard Conductivity:	0.0003 ohms max. per IEC 60512-2, test 2b.
High Conductivity:	0.0003 ohms max. per IEC 60512-2, test 2b.

SHIELDED CONTACTS

Initial Contact Resistance:	0.008 ohms maximum.
Nominal Impedance:	50 ohms.
Insertion Loss:	-0.46 dB at 1 GHz -1.5 dB at 2 GHz
VSWR:	1.15 average at 1 GHz 1.56 average at 2 GHz
Above values measured using frequency domain techniques.	
Proof Voltage:	1000 V r.m.s.

ELECTRICAL CHARACTERISTICS, CONTINUED:

HIGH VOLTAGE CONTACTS

Flash over Voltage:	3600 V r.m.s.
Proof Voltage:	2700 V r.m.s.
Initial Contact Resistance:	0.008 ohms maximum.

CONNECTOR

Insulation Resistance:	5 G ohms per IEC 60512-2, test 3a, method A. 600 V rms.
Working Voltage:	2200 V rms per IEC 60512-2, test 4a, method C.
Clearance and Creepage Distance:	0.080 inch [2.03 mm]
Working Temperature:	-55°C to +125°C.

MECHANICAL CHARACTERISTICS:

SIGNAL CONTACTS

Removable:	Insert contact to rear face of insulator, release from front face of insulator. Size 20 contacts, 0.040 inch [1.02 mm] diameter male contacts, closed entry design female contacts.
Fixed:	Straight solder, right angle (90°) solder and straight compliant press-in printed board mount terminations. Size 20 contacts, 0.040 inch [1.02 mm] diameter male contacts, open entry design female contacts.

... continued on next page

CUL Recognized
File # E49351



continued from previous page . . .

MECHANICAL CHARACTERISTICS, CONTINUED:

POWER CONTACTS:

Removable: Insert contact to rear face of insulator, release from front face of insulator. Size 8 contacts, 0.142 inch [3.61 mm] diameter male contacts, closed entry design female contacts.

Printed Board Mount: Straight solder, right angle (90°) solder and straight compliant press-in printed board mount terminations. Size 8 contacts, 0.142 inch [3.61 mm] male contacts, closed entry design female contacts.

SHIELDED CONTACTS:

Removable: Insert contact to rear face of insulator, release from front face of insulator. Size 8 contacts. See page 53 table of cable sizes for contact termination dimensions.

HIGH VOLTAGE CONTACTS:

Removable: Insert contact to rear face of insulator, release from front face of insulator. Size 8 contacts. Straight and right angle (90°) terminations. 0.041 inch [1.04 mm] minimum hole diameter.

Contact Terminations: 20-24 AWG [0.5-0.25mm²] removable crimp signal, 0.028 inch [0.71 mm] diameter straight and right angle (90°) solder printed board mount,

8-16 AWG [10.0-1.0mm²] removable solder and crimp power, 0.125 inch [3.18 mm] diameter straight and right angle (90°) solder printed board mount, power, shielded, high voltage cable, and straight compliant press-in terminations.

Contact Retention in Insulator:

Fixed signal - 9 lbs. [40 N].
Removable Signal - 10 lbs. [44N].
Power, shielded and high voltage - 22 lbs. [98 N].

Resistance to Solder Iron Heat:

500° F [260° C] for 10 second duration per IEC 60512-6, test 12e, 25 watt soldering iron.

Connection Systems:

Connector provides cable to cable, cable to printed board, cable to panel mount and printed board to printed board application.

Locking System:

Insulators provide locking between cable to cable, cable to printed board and cable to panel mount applications.

Polarizations:

Provided in insulator design.

Mounting to Printed Board:

Rapid installation push-on fasteners. Self-tapping screws for compliant connectors.

Mechanical Operations:

500 operations per IEC 60512-5.

TEMPERATURE RISE CURVES

STANDARD CONTACT MATERIAL

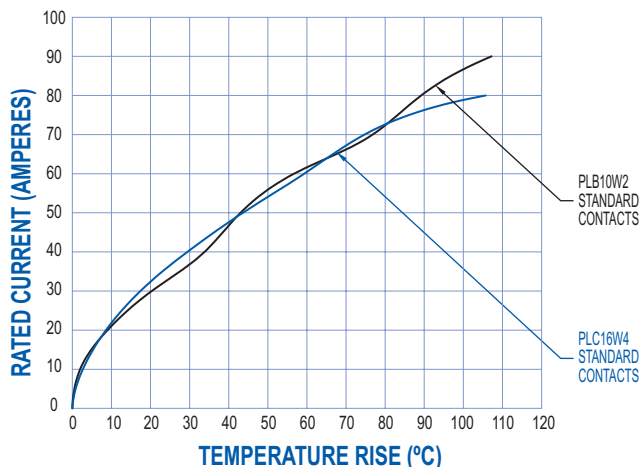

Test conducted in accordance with UL1977.
All power contacts under load.

10W2: Curve developed using PLB10W2F9300A1 and PLB10W2M0000 connectors with MC4008D contacts terminated to 8 AWG wire .

16W4: Curve developed using PLC16W4F9300A1 and PLC16W4M0000 connectors with MC4008D contacts terminated to 8 AWG wire.

HIGH CONDUCTIVITY CONTACT MATERIAL

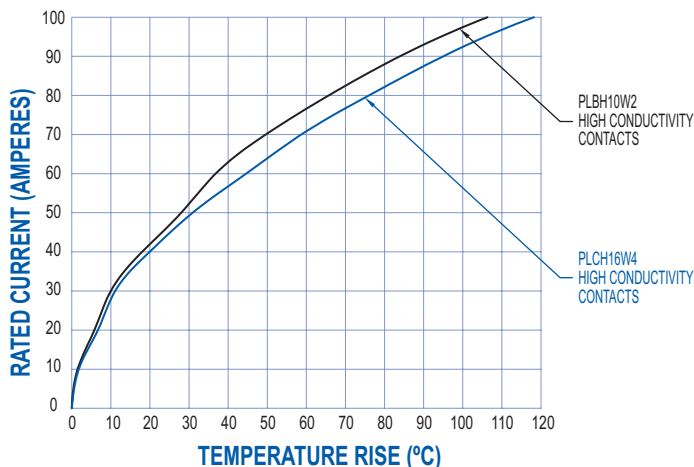

Test conducted in accordance with UL1977.
All power contacts under load.

10W2: Curve developed using PLBH10W2F9300A1 and PLB10W2M0000 connectors with MC4008DS contacts terminated to 8 AWG wire .

16W4: Curve developed using PLCH16W4F9300A1 and PLC16W4M0000 connectors with MC4008DS contacts terminated to 8 AWG wire.

PLB10W2 CABLE CONNECTOR
FOR USE WITH SIZE 20 AND SIZE 8 REMOVABLE CONTACTS
CODE 0

CONTACTS ARE NOT SUPPLIED WITH CONNECTOR AND MUST BE ORDERED SEPARATELY

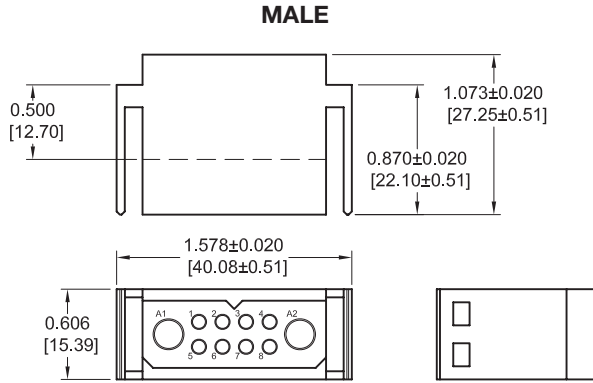

Part Number:
PLB10W2M0000

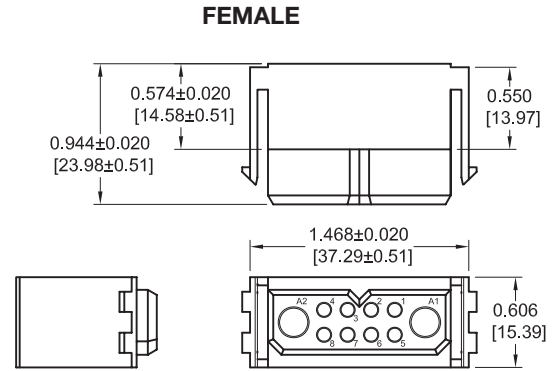

Part Number:
PLB10W2F0000

PLC16W4 CABLE CONNECTOR
FOR USE WITH SIZE 20 AND SIZE 8 REMOVABLE CONTACTS
CODE 0

CONTACTS ARE NOT SUPPLIED WITH CONNECTOR AND MUST BE ORDERED SEPARATELY

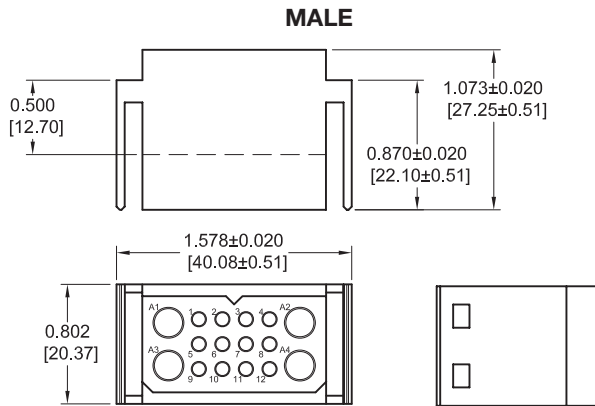

Part Number:
PLC16W4M0000

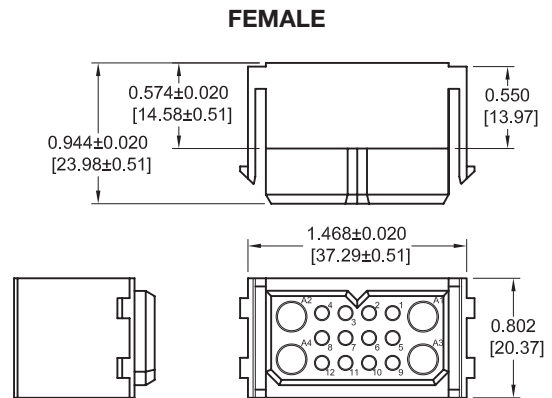

Part Number:
PLC16W4F0000

For information regarding size 20 and size 8 removable contacts, see Removable Contact section, pages 47-53.



PLB10W2 PANEL MOUNT CONNECTOR FOR USE WITH SIZE 20 AND SIZE 8 REMOVABLE CONTACTS CODE 1

CONTACTS ARE NOT SUPPLIED WITH CONNECTOR AND MUST BE ORDERED SEPARATELY

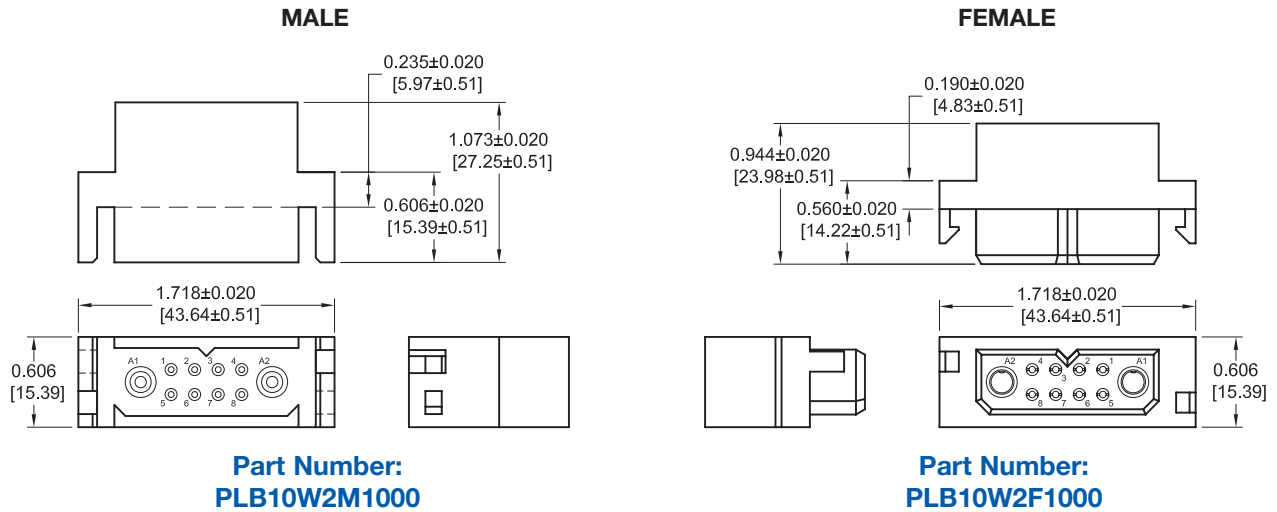

For panel cutout, see chart on page 63.

NOTE: MOUNTING SCREWS CAN BE SUPPLIED WITH CONNECTORS USING STEP 5 IN ORDERING INFORMATION ON PAGE 46. MOUNTING SCREWS CAN ALSO BE ORDERED SEPARATELY BY PART NUMBER. SEE PAGE 59.

PLC16W4 PANEL MOUNT CONNECTOR FOR USE WITH SIZE 20 AND SIZE 8 REMOVABLE CONTACTS CODE 1

CONTACTS ARE NOT SUPPLIED WITH CONNECTOR AND MUST BE ORDERED SEPARATELY

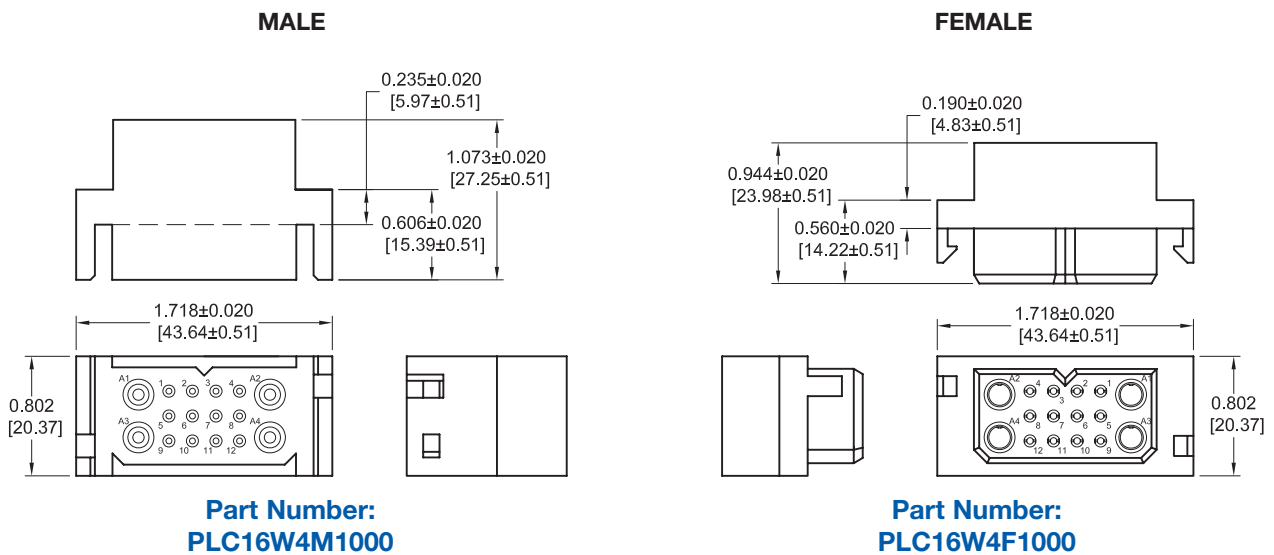

For panel cutout, see chart on page 63

NOTE: MOUNTING SCREWS CAN BE SUPPLIED WITH CONNECTORS USING STEP 5 IN ORDERING INFORMATION ON PAGE 46. MOUNTING SCREWS CAN ALSO BE ORDERED SEPARATELY BY PART NUMBER. SEE PAGE 59.

For information regarding size 20 and size 8 removable contacts, see Removable Contact section, pages 47-53.

PLB(H)10W2 STRAIGHT PRINTED BOARD MOUNT CONNECTOR CODE 3, 0.146 [3.71] CONTACT EXTENSION

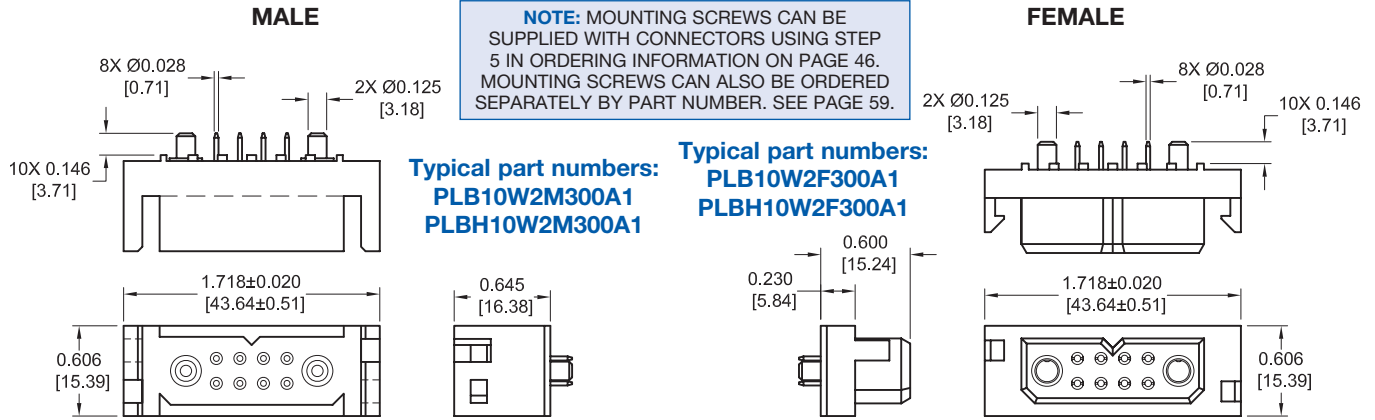

PLC(H)16W4 STRAIGHT PRINTED BOARD MOUNT CONNECTOR CODE 3, 0.146 [3.71] CONTACT EXTENSION

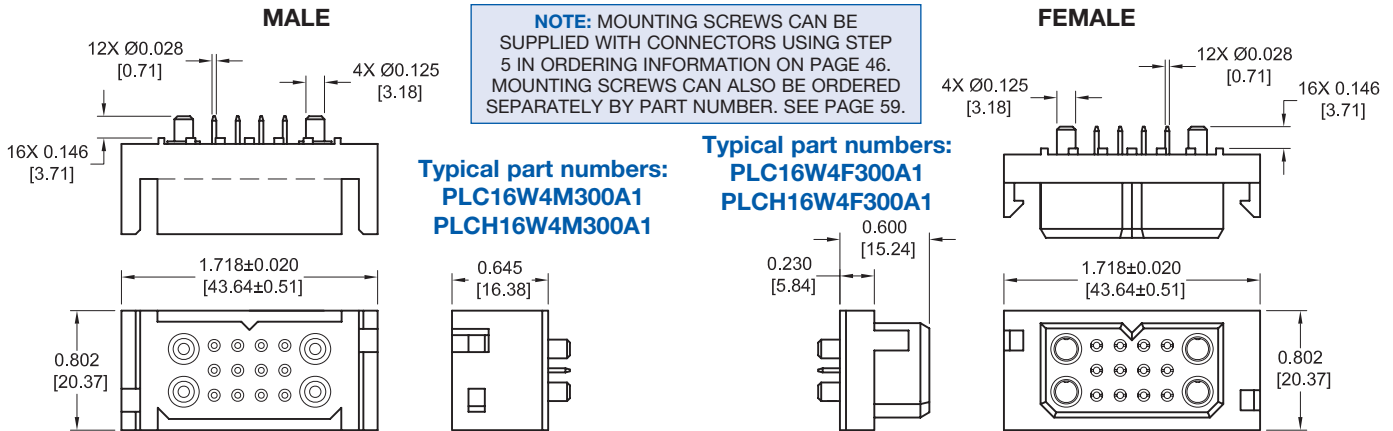

STRAIGHT SOLDER AND COMPLIANT CONTACT HOLE PATTERN

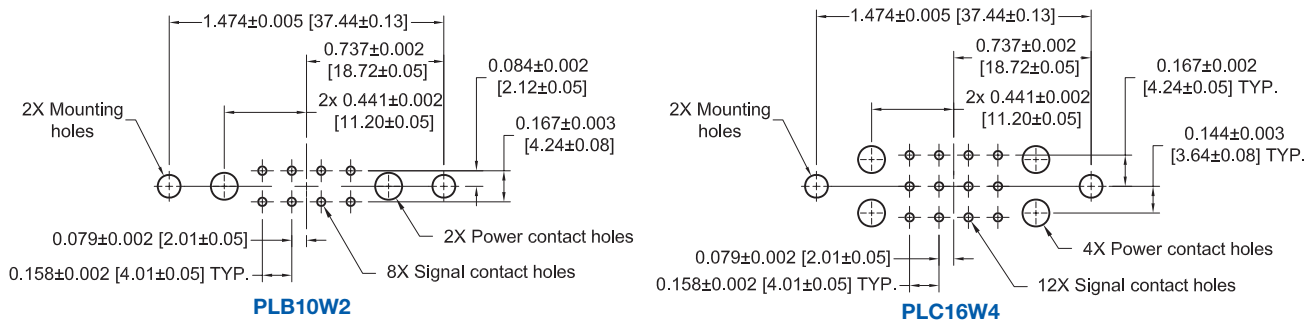

SUGGESTED PRINTED BOARD HOLE SIZES:

- Suggest 0.145 [3.68] Ø hole in printed board for power contact termination positions.
- Suggest 0.045 [1.14] Ø hole for signal solder contact termination positions.
- Suggest 0.100 [2.54] Ø hole in printed board when mounting connectors with #2 thread forming screws.
- Suggest 0.123±0.003 [3.12±0.08] Ø hole in printed board for mounting connector with push-on fasteners.

NOTE: See page 57 for suggested printed board drill hole sizes, recommended plating and finished hole sizes for compliant contact termination positions.



Positronic
connectpositronic.com

RIGHT ANGLE (90°) PRINTED BOARD CONNECTOR AND CONTACT HOLE PATTERN

Power
Connection
Systems

PLB(H)10W2 RIGHT ANGLE (90°) PRINTED BOARD MOUNT CONNECTOR CODE 4, 0.146 [3.71] CONTACT EXTENSION

NOTE:
MOUNTING
SCREWS CAN
BE ORDERED
SEPARATELY
BY PART
NUMBER
WHEN
CHOOSING B3
BRACKETS.
SEE PAGE 59.

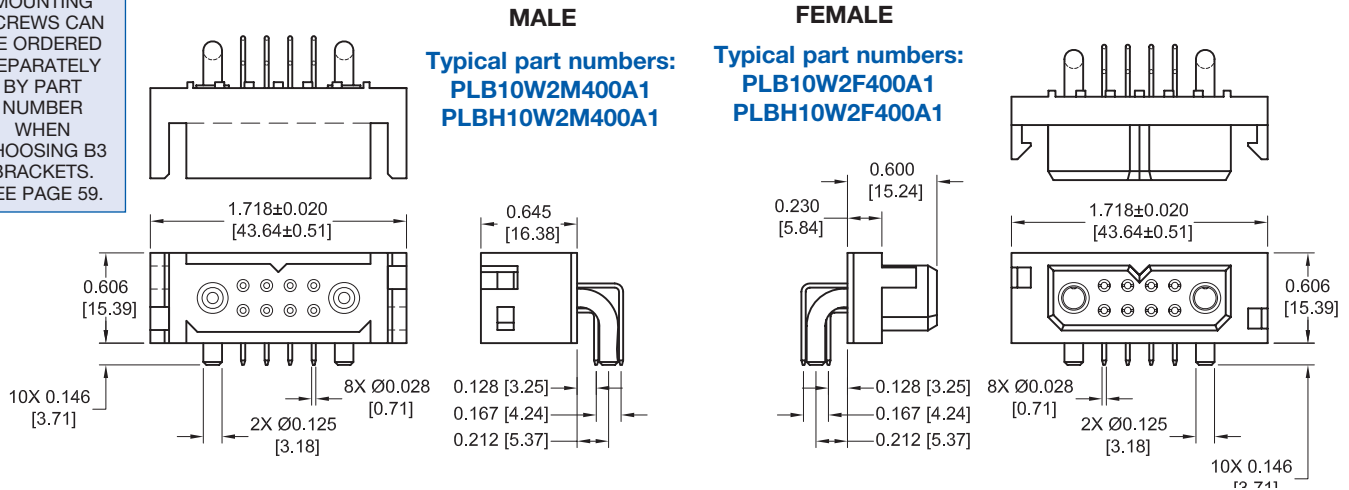

PLC(H)16W4 RIGHT ANGLE (90°) PRINTED BOARD MOUNT CONNECTOR CODE 4, 0.146 [3.71] CONTACT EXTENSION

NOTE:
MOUNTING
SCREWS CAN
BE ORDERED
SEPARATELY
BY PART
NUMBER
WHEN
CHOOSING B3
BRACKETS.
SEE PAGE 59.

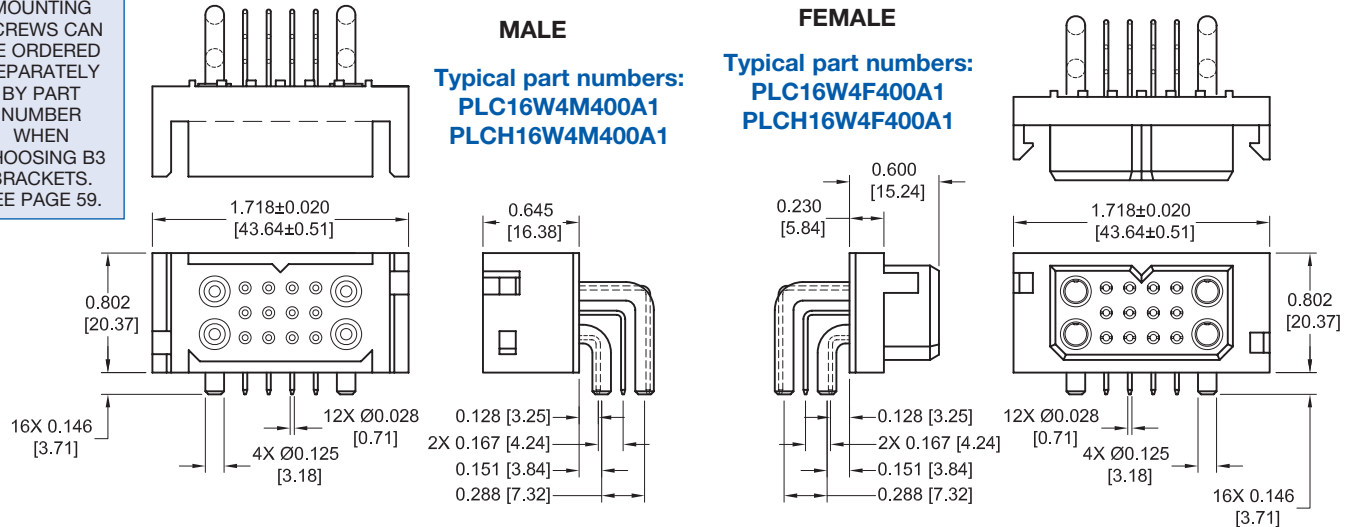

RIGHT ANGLE (90°) PRINTED BOARD MOUNT CONTACT HOLE PATTERN

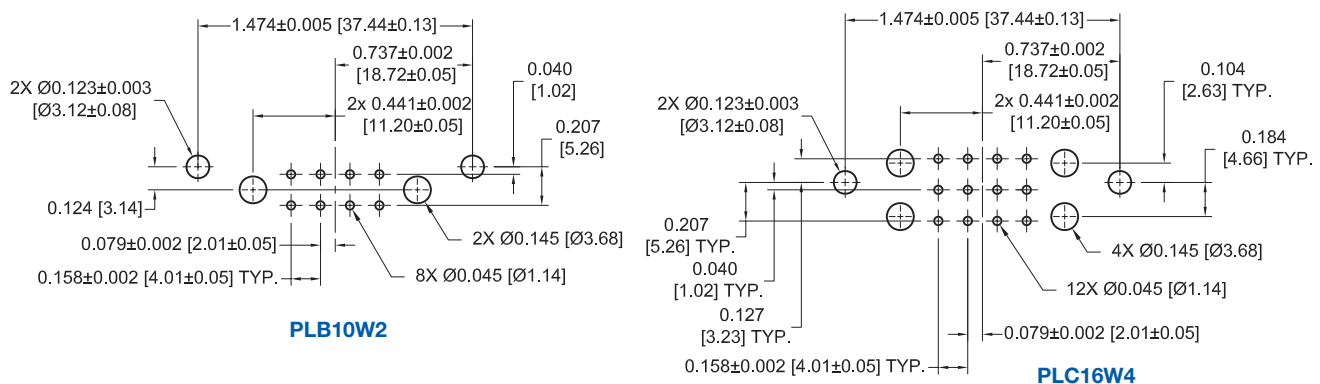

PLB(H)10W2 COMPLIANT PRESS-IN CONNECTOR

CODE 93

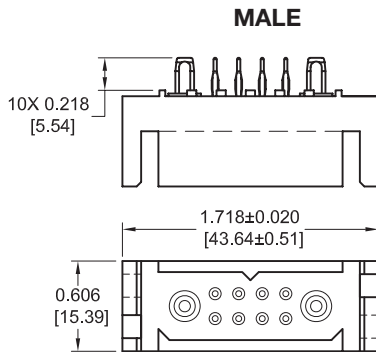

NOTE: Positronic **recommends** the practice of **using mounting hardware** to secure connector to printed circuit board. Mounting screws can be supplied with connectors using step 5 in ordering information on page 46. Mounting screws can also be ordered separately by part number. See page 59.

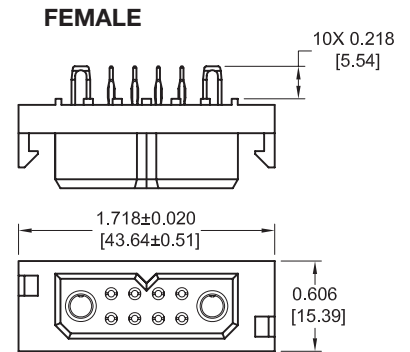
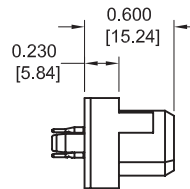
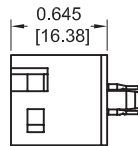

Typical part numbers:
PLB10W2M9300A1
PLBH10W2M9300A1

Typical part numbers:
PLB10W2F9300A1
PLBH10W2F9300A1

NOTE: Connectors are designed to be mounted to the printed circuit board with screws, see page 59 for mounting screw information. See page 43 for contact hole pattern.

PLC(H)16W4 COMPLIANT PRESS-IN CONNECTOR

CODE 93

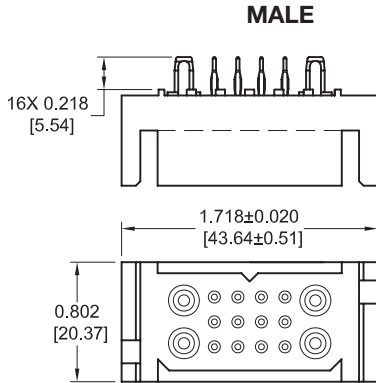

NOTE: Positronic **recommends** the practice of **using mounting hardware** to secure connector to printed circuit board. Mounting screws can be supplied with connectors using step 5 in ordering information on page 46. Mounting screws can also be ordered separately by part number. See page 59.

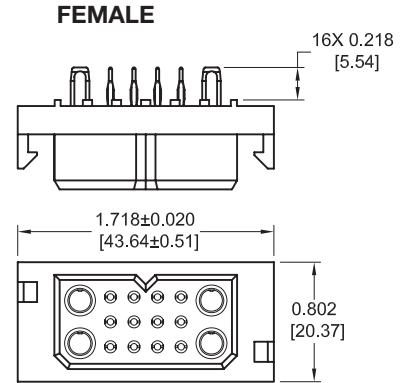
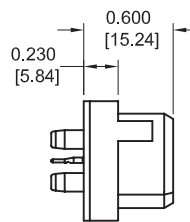
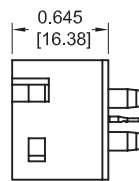

Typical part numbers:
PLC16W4M9300A1
PLCH16W4M9300A1

Typical part numbers:
PLC16W4F9300A1
PLCH16W4F9300A1

NOTE: Connectors are designed to be mounted to the printed circuit board with screws, see page 59 for mounting screw information. See page 43 for contact hole pattern.



Positronic
connectpositronic.com

PCS MIXED DENSITY CONNECTOR ORDERING INFORMATION

Power
Connection
Systems

ORDERING INFORMATION - CODE NUMBERING SYSTEM

Specify Complete Connector By Selecting An Option From Step 1 Through 7

STEP	1	2	3	4	5	6	7	8	9
EXAMPLE	PLC	16W4	F	4	B3N	0	A1	/AA	

STEP 1 - BASIC SERIES

- PLB - 2 Row
- PLBH - 2 Row High conductivity contacts
- PLC - 3 Row
- PLCH - 3 Row High conductivity contacts

STEP 2 - CONNECTOR VARIANTS

- 2 Row - 10W2
- 3 Row - 16W4

STEP 3 - CONNECTOR GENDER

- M - Male
- F - Female

STEP 4 - CONTACT TERMINATION TYPE

- 0 - Removable contact, cable connector. Order contacts separately, see pages 47-53.
- *1 - Removable contact, panel mounted connector. Order contacts separately, see pages 47-53.
- *3 - Solder, Straight Printed Board Mount with 0.146 [3.71] tail extension.
- 4 - Solder, Right Angle (90°) Printed Board Mount with 0.146 [3.71] tail extension.
- *93 - Straight Printed Board Mount, Press-in, length 0.218 [5.54] for 0.125 inch [3.18] thick board.

STEP 5 - MOUNTING STYLE

- 0 - None.
- B - Metal Right Angle (90°) Mounting Bracket.
- BN - Metal Right Angle (90°) Mounting Bracket with Push-on Fastener.
- B3 - Plastic Right Angle (90°) Mounting Bracket with Cross Bar.
- B3N - Plastic Right Angle (90°) Mounting Bracket with Cross Bar and Push-on Fastener.
- N - Push-On Fastener For Straight Printed Board Mount Connectors
- ST2 - Self-tapping steel screws 2-28 x 0.250+0.030 [6.35+0.76] length for 0.093 [2.36] thick board.
- ST3 - Self-tapping steel screws 2-28 x 0.312+0.030 [7.92+0.76] length for 0.125 [3.18] thick board.
- ST4 - Self-tapping steel screws 2-28 x 0.375+0.030 [9.53+0.76] length for 0.175 [4.45] thick board.
- SS2 - Self-tapping stainless steel screws 2-28 x 0.250+0.030 [6.35+0.76] length for 0.093 [2.36] thick board.
- SS3 - Self-tapping stainless steel screws 2-28 x 0.312+0.030 [7.92+0.76] length for 0.125 [3.18] thick board.
- SS4 - Self-tapping stainless steel screws 2-28 x 0.375+0.030 [9.53+0.76] length for 0.175 [4.45] thick board.

NOTE: Once you have made a connector selection, contact Technical Sales if you would like to receive a drawing in DXF, PDF format or a 3-D IGES, STEP, or SOLIDWORKS file.

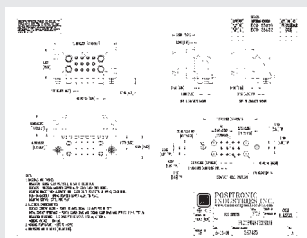

2-D Drawing

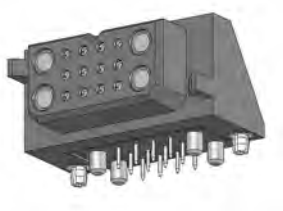

3-D Model

STEP 9 - SPECIAL OPTIONS

CONTACT TECHNICAL SALES
FOR SPECIAL OPTIONS

STEP 8 - ENVIRONMENTAL COMPLIANCE OPTIONS

/AA - RoHS Compliant

NOTE: If compliance to environmental legislation is not required, this step will not be used.
Example: PLC16W4F4B3N0A1

STEP 7 - CONTACT PLATING FOR PRINTED BOARD CONNECTORS

- 0 - Crimp Contacts ordered separately, see page 47-53.
- A1 - Gold flash over nickel on mating end and termination end.
- A2 - Gold flash over nickel on mating end and 0.00020 inch [5.00µ] tin-lead solder coat on termination end. Not available with code 93 in step 4.
- C1 - 0.000030 inch [0.76µ] gold over nickel on mating end and termination end.
- C2 - 0.000030 inch [0.76µ] gold over nickel on mating end and 0.00020 inch [5.00µ] tin-lead solder coated termination end. Not available with code 93 in step 4.
- D1 - 0.000050 inch [1.27µ] gold over nickel on mating end and termination end.
- D2 - 0.000050 inch [1.27µ] gold over nickel on mating end and 0.00020 inch [5.00µ] tin-lead solder coated termination end. Not available with code 93 in step 4.

STEP 6 - HOODS AND PANEL MOUNT

- 0 - None.
- 51 - Top Opening Hood.
- 6 - Panel Mount, quick release.
- 81 - Panel Mount, fixed for 0.040 [1.02] thick panel.
- 82 - Panel Mount, fixed for 0.060 [1.52] thick panel.
- 83 - Panel Mount, fixed for 0.090 [2.29] thick panel.
- 11 - Blind Mating System for 0.040 [1.02] thick panel.
- 12 - Blind Mating System for 0.060 [1.52] thick panel.
- 13 - Blind Mating System for 0.090 [2.29] thick panel.
- 14 - Blind Mating System for 0.120 [3.05] thick panel..

*1 Mounting screws are available with code 1, 3 and 93. To order mounting screws separately, see page 59 for part numbers.

REMOVABLE CONTACT TECHNICAL CHARACTERISTICS

SIZE 20 REMOVABLE CONTACT

MATERIALS AND FINISHES:

STANDARD: Precision machined copper alloy with gold flash over nickel. Other finishes are available, see optional plating finishes for -14 and -15.

MECHANICAL CHARACTERISTICS:

STANDARD: Insert contact to rear face of insulator, release from front face of insulator. Size 20 contacts, 0.040 inch [1.02 mm] diameter male contacts, closed entry design female contacts.

ELECTRICAL CHARACTERISTICS:

Contact Current Rating: 7.5 amperes nominal.
Initial Contact Resistance: 0.007 ohms max. per IEC 60512-2, test 2b.

SIZE 16 REMOVABLE CONTACT

MATERIALS AND FINISHES:

STANDARD: Precision machined copper alloy with gold flash over nickel. Other finishes are available, see optional plating finishes for -14 and -15.

HIGH CONDUCTIVITY: Tellurium copper, gold flash over nickel. Other finishes are available, see optional plating finishes for -14 and -15.

SHIELDED:

Dielectric Material: PCTFE
Inner Contacts: Phosphor bronze, 0.000030 inch [0.76 μ] gold over nickel. Other finishes are available, see optional plating finishes for -15.
Outer Contacts: Brass and beryllium copper, gold flash over nickel. Other finishes are available, see optional plating finishes for -14.

MECHANICAL CHARACTERISTICS:

STANDARD AND HIGH CONDUCTIVITY: Insert contact to rear face of insulator, release from front face of insulator. Size 16 contacts, 0.0625 inch [1.588 mm] diameter male contacts. Female contact closed entry for highest reliability.

SHIELDED:

Contact Retention In Insulator: 18 lbs. [80N].
Removable Contacts: Rear insertion, front removable.
Insertion Force Per Contact: 8 oz. [2.2N] per contact maximum
Durability: 100 cycles minimum.
Vibration: 20g from 10 Hz to 500 Hz
Shock: 30g - 11 ms

ELECTRICAL CHARACTERISTICS:

STANDARD:
Contact Current Rating: See page 9 for detail information.
Initial Contact Resistance: 0.0016 ohms max. per IEC 60512-2, test 2b.

HIGH CONDUCTIVITY:

Contact Current Rating: See page 9 for detail information.
Initial Contact Resistance: 0.0007 ohms max. per IEC 60512-2, test 2b.

SHIELDED:

Dielectric Strength At Sea Level: 600 V rms
Initial Contact Resistance: 0.012 ohms maximum
Insulation Resistance: 5 G ohms
Insertion Loss: 0.2 dB at 500 MHz for 126N contacts
1.0 dB at 500 MHz for 226N contacts
VSWR: 170 at 0 to 200 MHz
2.25 at 200 to 500 MHz

SIZE 12 REMOVABLE CONTACT

MATERIALS AND FINISHES:

STANDARD: Precision machined copper alloy with gold flash over nickel. Other finishes are available, see optional plating finishes for -14 and -15.

HIGH CONDUCTIVITY: Tellurium copper, gold flash over nickel. Other finishes are available, see optional plating finishes for -14 and -15.

MECHANICAL CHARACTERISTICS:

STANDARD AND HIGH CONDUCTIVITY: Insert contact to rear face of insulator, release from front face of insulator. Size 12 contacts, 0.094 inch [2.39 mm] diameter male contacts. Female contact closed entry for highest reliability.

ELECTRICAL CHARACTERISTICS:

STANDARD:
Contact Current Rating: 40 amperes continuous, derated per IEC 60512-3, test 5b.
Initial Contact Resistance: 0.001 ohms max. per IEC 60512-2, test 2b.
HIGH CONDUCTIVITY:
Contact Current Rating: See page 33 for detail information.
Initial Contact Resistance: 0.0007 ohms max. per IEC 60512-2, test 2b.

SIZE 8 REMOVABLE CONTACT

MATERIALS AND FINISHES:

STANDARD: Precision machined copper alloy with gold flash over nickel. Other finishes are available, see optional plating finishes for -14 and -15.

HIGH CONDUCTIVITY: Tellurium copper, gold flash over nickel. Other finishes are available, see optional plating finishes for -14 and -15.

HIGH VOLTAGE:

Insulator Material: PTFE teflon
Contacts: Male contacts, brass. Female contacts, phosphor bronze. Male and female contacts, 0.000030 inch [0.76 μ] gold over nickel. Other finishes are available, see optional plating finishes for -15.

SHIELDED:

Dielectric Material: PTFE teflon
Inner Contacts: Phosphor bronze, 0.000030 inch [0.76 μ] gold over nickel. Other finishes are available, see optional plating finishes for -15.
Outer Contacts: Brass and beryllium copper, gold flash over nickel. Other finishes are available, see optional plating finishes for -14.

... continued on next page

For information regarding CRIMP TOOLS & CRIMPING TOOL TECHNIQUES, see page 54.



REMOVABLE CONTACT TECHNICAL CHARACTERISTICS

continued from previous page . . .

MECHANICAL CHARACTERISTICS:

STANDARD AND HIGH CONDUCTIVITY:

Insert contact to rear face of insulator, release from front face of insulator. Size 8 contacts, 0.142 inch [3.61 mm] diameter male contacts, closed entry design female contacts.

HIGH VOLTAGE:

Insert contact to rear face of insulator, release from front face of insulator. Size 8 contacts. Straight and right angle (90°) terminations. 0.041 inch [1.04 mm] minimum hole diameter.

Durability:

500 cycles minimum.

Vibration:

20g from 10 Hz to 500 Hz.

Shock:

30g-11ms.

SHIELDED:

Insert contact to rear face of insulator, release from front face of insulator. Size 8 contacts. See page 53 table of cable sizes for contact Termination dimensions.

ELECTRICAL CHARACTERISTICS:

STANDARD:

Contact Current Rating: See temperature rise curves on page 40. For additional information see page 51-52.
Initial Contact Resistance: 0.001 ohms max. per IEC 60512-2, test 2b.

HIGH CONDUCTIVITY:

Contact Current Rating: See temperature rise curves on page 40.
Initial Contact Resistance: 0.0003 ohms max. per IEC 60512-2, test 2b.

HIGH VOLTAGE:

Flash over Voltage: 3600 V r.m.s.
Proof Voltage: 2700 V r.m.s.
Initial Contact Resistance: 0.008 ohms maximum.

SHIELDED:

Initial Contact Resistance: 0.008 ohms maximum.
Nominal Impedance: 50 ohms.
Insertion Loss: -0.46 dB at 1 GHz
-1.5 dB at 2 GHz

VSWR: 1.15 average at 1 GHz
1.56 average at 2 GHz

Above values measured using frequency domain techniques.

Proof Voltage: 1000 V r.m.s.

OPTIONAL PLATING FINISHES

- 14 0.000030 [0.76 μ] gold over nickel by adding "-14" suffix onto part number. *Example: FC720N2-14.*
- 15 0.000050 inch [1.27μ] gold over nickel by adding "-15". *Example: FC720N2-15.*

RoHS OPTIONS:

- /AA Environmental Compliance Option: RoHS compliant can be achieved by adding "/AA" suffix onto part number. *Examples: FC720N2/AA or for optional plating finishes use FC720N2/AA-14.*

REELED CONTACTS:

Contacts may be supplied in plastic carriers, packaged in reels holding 2,000 contacts for use with the automatic pneumatic crimp tools, catalog part numbers 9550-0 and 9550-1; packaged in reels holding 1,000 contacts for use with the automatic pneumatic crimp tools, catalog part number 9555-0-2. The same type carrier is used for both male and female contacts.

All male and female crimp contacts can be ordered in reels by adding letter "R" after the contact part number, such as MC6020DR for a male contact and FC6026DR for a female contact.

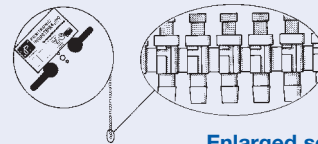

Enlarged section of plastic contact carriers

REMOVABLE CRIMP SIGNAL CONTACT

FOR USE WITH PCS MIXED DENSITY SERIES CONNECTORS

CONTACTS MUST BE ORDERED SEPARATELY

SIZE 20

FEMALE CONTACT

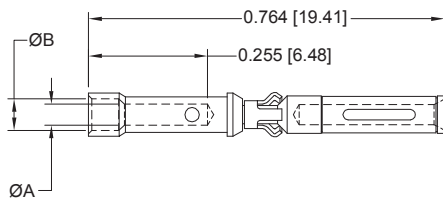

PART NUMBER	WIRE SIZE AWG/[mm ²]	ØA	ØB
FC720N2	20 / 22 / 24 [0.5 / 0.3 / 0.25]	0.045 [1.14]	0.068 [1.73]

MALE CONTACT

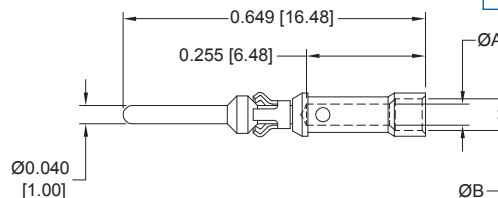

PART NUMBER	WIRE SIZE AWG/[mm ²]	ØA	ØB
MC720N3	20 / 22 / 24 [0.5 / 0.3 / 0.25]	0.045 [1.14]	0.068 [1.73]

Note: Connectors can be kitted with all applicable crimp/solder contacts, contact Technical Sales for connector part number.

For information regarding CRIMP TOOLS & CRIMPING TOOL TECHNIQUES, see page 54.

REMOVABLE CONTACT

See page 9 for
current ratings.

REMOVABLE CRIMP CONTACT
FOR USE WITH PCS SERIES CONNECTORS
CONTACTS MUST BE ORDERED SEPARATELY
SIZE 16

Note: Connectors can be kitted
with all applicable crimp/
solder contacts, con-
tact Technical Sales for
connector part number.

FEMALE CONTACT
"CLOSED ENTRY" DESIGN

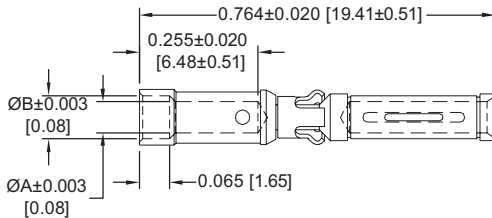

MALE CONTACT

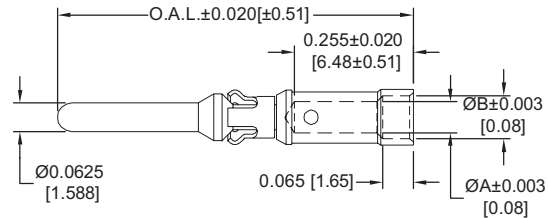

PART NUMBERS	WIRE SIZE AWG/[mm ²]	ØA	ØB
FC112N2	12 [4.0]	0.098 [2.49]	N/A
FC112N2S	12 [4.0]	0.098 [2.49]	N/A
FC114N2	14-16 [2.5-1.5]	0.081 [2.06]	0.105 [2.67]
FC116N2	16-18 [1.5-1.0]	0.067 [1.70]	0.093 [2.36]
FC120N2	20-22-24 [0.5-0.3-0.25]	0.045 [1.14]	0.068 [1.73]

"S" in
part number
indicates high
conductivity
material.

Compatible
with PL*H
PCB mount
connectors.
See ordering
information.

PART NUMBERS	WIRE SIZE AWG/[mm ²]	ØA	ØB	OAL
MC112N	12 [4.0]	0.098 [2.49]	N/A	0.764 [19.41]
MC112NS	12 [4.0]	0.098 [2.49]	N/A	0.764 [19.41]
*MC112N-133.0	12 [4.0]	0.098 [2.49]	N/A	0.684 [17.37]
*MC112N-133.1	12 [4.0]	0.098 [2.49]	N/A	0.724 [18.39]
*MC112N-133.2	12 [4.0]	0.098 [2.49]	N/A	0.744 [18.90]
*MC112N-133.3	12 [4.0]	0.098 [2.49]	N/A	0.804 [20.42]
MC114N	14-16 [2.5-1.5]	0.081 [2.06]	0.105 [2.67]	0.764 [19.41]
MC116N	16-18 [1.5-1.0]	0.067 [1.70]	0.093 [2.36]	0.764 [19.41]
*MC116N-133.0	16-18 [1.5-1.0]	0.067 [1.70]	0.093 [2.36]	0.684 [17.37]
*MC116N-133.1	16-18 [1.5-1.0]	0.067 [1.70]	0.093 [2.36]	0.724 [18.39]
*MC116N-133.2	16-18 [1.5-1.0]	0.067 [1.70]	0.093 [2.36]	0.744 [18.90]
*MC116N-133.3	16-18 [1.5-1.0]	0.067 [1.70]	0.093 [2.36]	0.804 [20.42]
MC120N	20-22-24 [0.5-0.3-0.25]	0.045 [1.14]	0.068 [1.73]	0.764 [19.41]

* indicates Sequential mate contacts,
see page 25 for more information
regarding Sequential Mating System.

See page 9 for
current ratings.

REMOVABLE SOLDER CUP CONTACT
FOR USE WITH PCS SERIES CONNECTORS
CONTACTS MUST BE ORDERED SEPARATELY
SIZE 16

Note: Connectors can be kitted
with all applicable crimp/
solder contacts, con-
tact Technical Sales for
connector part number.

FEMALE CONTACT
"CLOSED ENTRY" DESIGN

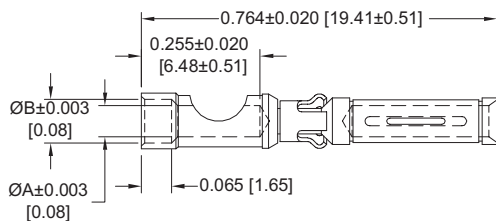

MALE CONTACT

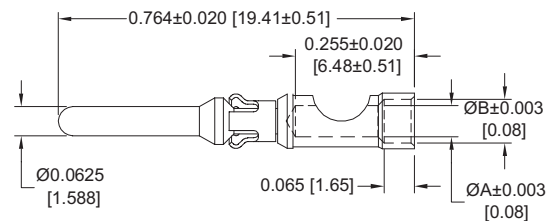

PART NUMBERS	WIRE SIZE AWG/[mm ²]	ØA	ØB
FS112N2	12 [4.0]	0.098 [2.49]	N/A
FS112N2S	12 [4.0]	0.098 [2.49]	N/A
FS114N2	14 [2.5]	0.081 [2.06]	0.105 [2.67]
FS116N2	16 [1.5]	0.067 [1.70]	0.093 [2.36]
FS120N2	20 [0.5]	0.045 [1.14]	0.068 [1.73]

"S" in
part number
indicates high
conductivity
material.

Compatible
with PL*H
PCB mount
connectors.
See ordering
information.

PART NUMBERS	WIRE SIZE AWG/[mm ²]	ØA	ØB
MS112N	12 [4.0]	0.098 [2.49]	N/A
MS112NS	12 [4.0]	0.098 [2.49]	N/A
MS114N	14 [2.5]	0.081 [2.06]	0.105 [2.67]
MS116N	16 [1.5]	0.067 [1.70]	0.093 [2.36]
MS120N	20 [0.5]	0.045 [1.14]	0.068 [1.73]

For information regarding **CRIMP TOOLS & CRIMPING TOOL TECHNIQUES**, see page 54.



Positronic
connectpositronic.com

REMOVABLE SHIELDED AND CRIMP CONTACT SIZE 16 AND SIZE 12

Power
Connection
Systems

REMOVABLE CRIMP SHIELDED CONTACT FOR USE WITH PCS SERIES CONNECTORS CONTACTS MUST BE ORDERED SEPARATELY SIZE 16

Note: Connectors can be kitted with all applicable crimp/solder contacts, contact Technical Sales for connector part number.

MALE CONTACT

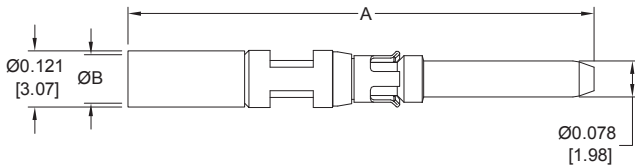

FEMALE CONTACT

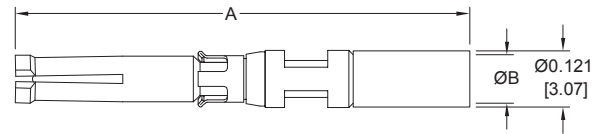

PART NUMBERS	CABLE SIZE	CHARACT. IMPED.	A	ØB
MCS126N	RG 178 B/U	50 ohms	0.993 [25.22]	0.045 [1.14]
	RG 196 B/U	50 ohms		
MCS226N	RG 179 B/U	75 ohms	1.022 [25.96]	0.070 [1.78]
	RG 316 /U	50 ohms		

PART NUMBERS	CABLE SIZE	CHARACT. IMPED.	A	ØB
FCS126N2	RG 178 B/U	50 ohms	0.967 [24.56]	0.045 [1.14]
	RG 196 B/U	50 ohms		
FCS226N2	RG 179 B/U	75 ohms	1.022 [25.96]	0.070 [1.78]
	RG 316 /U	50 ohms		

REMOVABLE CONTACT

REMOVABLE CRIMP CONTACT

FOR USE WITH SHROUDED AND POWER INPUT CONNECTORS
CONTACTS MUST BE ORDERED SEPARATELY

SIZE 12

See page 33
for current ratings.

Note: Connectors can be kitted with all applicable crimp/solder contacts, contact Technical Sales for connector part number.

FEMALE CONTACT

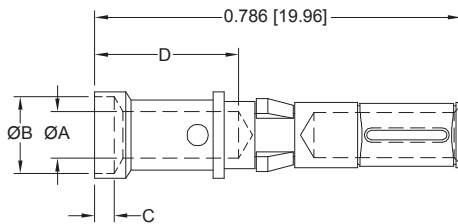

MALE CONTACT

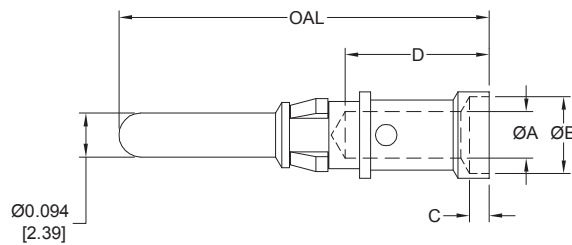

PART NUMBER	WIRE SIZE AWG/[mm ²]	ØA	ØB	C	D
FC610N2S	10 [6.0]	0.147 [3.73]	N/A	N/A	0.254 [6.45]
FC612N2	12 [4.0]	0.100 [2.54]	0.165 [4.19]	0.042 [1.06]	0.309 [7.85]

"S" in part number indicates high conductivity material.
Compatible with PLBH3W3 or PLSH PCB mount connectors. See ordering information.

PART NUMBER	WIRE SIZE AWG/[mm ²]	ØA	ØB	C	D	OAL
MC610NS	10 [6.0]	0.147 [3.73]	N/A	N/A	0.254 [6.45]	0.795 [20.19]
MC610NS-228.2	10 [6.0]	0.147 [3.73]	N/A	N/A	0.254 [6.45]	0.714 [18.14]
MC612N	12 [4.0]	0.100 [2.54]	0.165 [4.19]	0.042 [1.06]	0.309 [7.85]	0.795 [20.19]
MC612N-228.2	12 [4.0]	0.100 [2.54]	0.165 [4.19]	0.042 [1.06]	0.309 [7.85]	0.714 [18.14]

For information regarding CRIMP TOOLS & CRIMPING TOOL TECHNIQUES, see page 54.



REMOVABLE SOLDER CUP CONTACT

FOR USE WITH SHROUDED AND POWER INPUT CONNECTORS

CONTACTS MUST BE ORDERED SEPARATELY

SIZE 12

See page 33
for current ratings.

Note: Connectors can be kitted with all applicable crimp/solder contacts, contact Technical Sales for connector part number.

FEMALE CONTACT

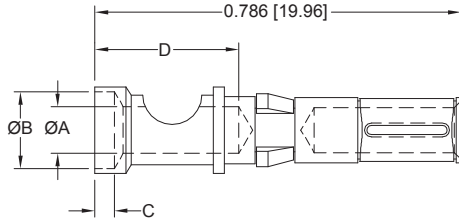

MALE CONTACT

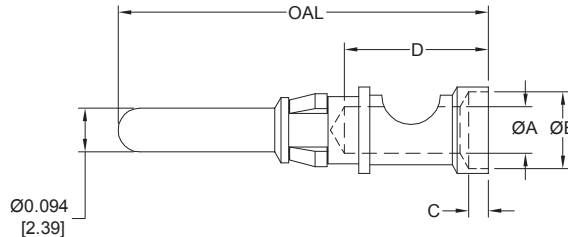

PART NUMBER	WIRE SIZE AWG/[mm ²]	ØA	ØB	C	D
FS610N2S	10 [6.0]	0.147 [3.73]	N/A	N/A	0.254 [6.45]
FS612N2	12 [4.0]	0.100 [2.54]	0.165 [4.19]	0.042 [1.06]	0.309 [7.85]

"S" in part number indicates high conductivity material.
Compatible with PLBH3W3 or PLSH PCB mount connectors. See ordering information.

PART NUMBER	WIRE SIZE AWG/[mm ²]	ØA	ØB	C	D	OAL
MS610NS	10 [6.0]	0.147 [3.73]	N/A	N/A	0.254 [6.45]	0.795 [20.19]
MS610NS-228.2	10 [6.0]	0.147 [3.73]	N/A	N/A	0.254 [6.45]	0.714 [18.14]
MS612N	12 [4.0]	0.100 [2.54]	0.165 [4.19]	0.042 [1.06]	0.309 [7.85]	0.795 [20.19]
MS612N-228.2	12 [4.0]	0.100 [2.54]	0.165 [4.19]	0.042 [1.06]	0.309 [7.85]	0.714 [18.14]

REMOVABLE CONTACT

REMOVABLE CRIMP CONTACT

FOR USE WITH PCS MIXED DENSITY SERIES CONNECTORS

CONTACTS MUST BE ORDERED SEPARATELY

SIZE 8

Note: Connectors can be kitted with all applicable crimp/solder contacts, contact Technical Sales for connector part number.

* FEMALE CONTACT CLOSED ENTRY, L.S.A.

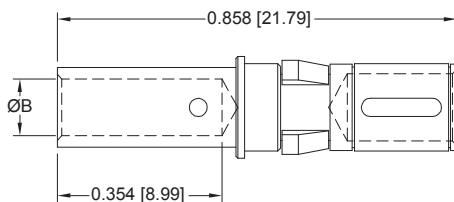

MALE CONTACT

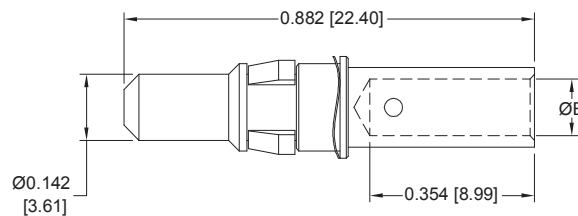

PART NUMBER	CURRENT RATING	WIRE SIZE AWG/[mm ²]	ØB
FC4008D	See Temp. Rise Curve, page 40.	8 / [10.0]	0.181 [4.60]
FC4008DS	See Temp. Rise Curve, page 40.	8 / [10.0]	0.181 [4.60]
FC4010D	30 amperes	10 / [6.0]	0.122 [3.10]
FC4012D	20 amperes	12 / [4.0]	0.101 [2.57]
FC4016D	10 amperes	16 / [1.5]	0.067 [1.70]

"S" in part number indicates high conductivity material.
Compatible with PL*H PCB mount connectors. See ordering information.

PART NUMBER	CURRENT RATING	WIRE SIZE AWG/[mm ²]	ØB
MC4008D	See Temp. Rise Curve, page 40.	8 / [10.0]	0.181 [4.60]
MC4008DS	See Temp. Rise Curve, page 40.	8 / [10.0]	0.181 [4.60]
MC4010D	30 amperes	10 / [6.0]	0.122 [3.10]
MC4012D	20 amperes	12 / [4.0]	0.101 [2.57]
MC4016D	10 amperes	16 / [1.5]	0.067 [1.70]

*NOTE: Female contacts feature Large Surface Area (L.S.A.) closed entry contact design which provides maximum mating surfaces between male and female contact and reduced contact resistance during operation.

For information regarding **CRIMP TOOLS & CRIMPING TOOL TECHNIQUES**, see page 54.



REMOVABLE HIGH VOLTAGE CONTACT SIZE 8

REMOVABLE SOLDER CUP CONTACT FOR USE WITH PCS MIXED DENSITY SERIES CONNECTORS CONTACTS MUST BE ORDERED SEPARATELY SIZE 8

Note: Connectors can be kitted with all applicable crimp/solder contacts, contact Technical Sales for connector part number.

* FEMALE CONTACT CLOSED ENTRY, L.S.A.

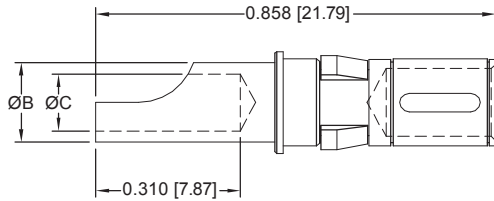

MALE CONTACT

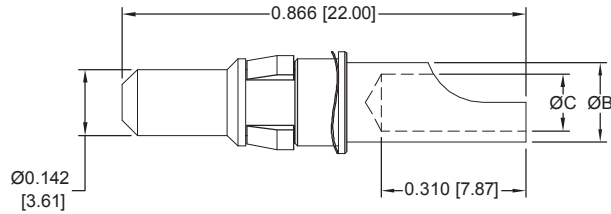

PART NUMBER	CURRENT RATING	WIRE SIZE AWG/[mm ²]	ØB	ØC
FS4008D	40 amperes	8 / [10.0]	0.219 [5.56]	0.182 [4.62]
FS4012D	20 amperes	12 / [4.0]	0.143 [3.63]	0.112 [2.84]
FS4016D	10 amperes	16 / [1.5]	0.100 [2.54]	0.069 [1.75]

PART NUMBER	CURRENT RATING	WIRE SIZE AWG/[mm ²]	ØB	ØC
MS4008D	40 amperes	8 / [10.0]	0.219 [5.56]	0.188 [4.78]
MS4012D	20 amperes	12 / [4.0]	0.143 [3.63]	0.112 [2.84]
MS4016D	10 amperes	16 / [1.5]	0.100 [2.54]	0.069 [1.75]

*NOTE: Female contacts feature Large Surface Area (L.S.A.) closed entry contact design which provides maximum mating surfaces between male and female contact and reduced contact resistance during operation.

REMOVABLE HIGH VOLTAGE CONTACT FOR USE WITH PCS MIXED DENSITY SERIES CONNECTORS CONTACTS MUST BE ORDERED SEPARATELY SIZE 8

Note: Connectors can be kitted with all applicable crimp/solder contacts, contact Technical Sales for connector part number.

STRAIGHT SOLDER WIRE TERMINATION

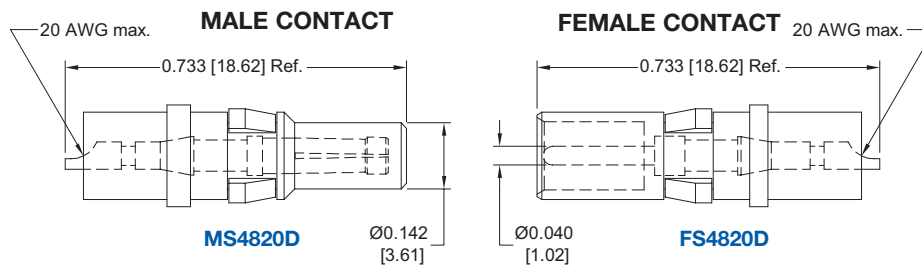

RIGHT ANGLE (90°) SOLDER WIRE TERMINATION

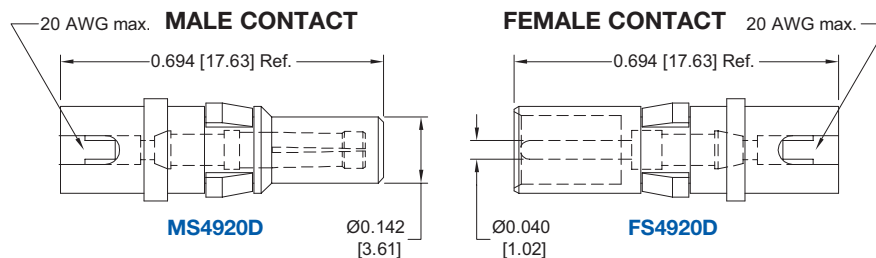

For information regarding CRIMP TOOLS & CRIMPING TOOL TECHNIQUES, see page 54.

REMOVABLE CONTACT



REMOVABLE HIGH VOLTAGE CONTACT SIZE 8

REMOVABLE SOLDER CUP CONTACT FOR USE WITH PCS MIXED DENSITY SERIES CONNECTORS CONTACTS MUST BE ORDERED SEPARATELY SIZE 8

Note: Connectors can be kitted with all applicable crimp/solder contacts, contact Technical Sales for connector part number.

* FEMALE CONTACT CLOSED ENTRY, L.S.A.

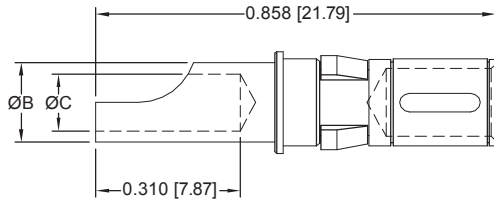

MALE CONTACT

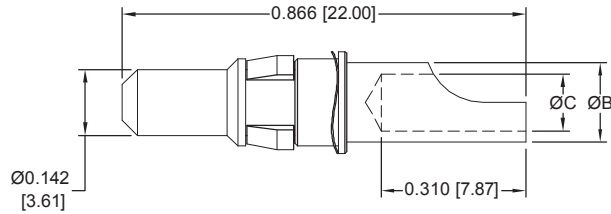

PART NUMBER	CURRENT RATING	WIRE SIZE AWG/[mm ²]	ØB	ØC
FS4008D	40 amperes	8 / [10.0]	0.219 [5.56]	0.182 [4.62]
FS4012D	20 amperes	12 / [4.0]	0.143 [3.63]	0.112 [2.84]
FS4016D	10 amperes	16 / [1.5]	0.100 [2.54]	0.069 [1.75]

PART NUMBER	CURRENT RATING	WIRE SIZE AWG/[mm ²]	ØB	ØC
MS4008D	40 amperes	8 / [10.0]	0.219 [5.56]	0.188 [4.78]
MS4012D	20 amperes	12 / [4.0]	0.143 [3.63]	0.112 [2.84]
MS4016D	10 amperes	16 / [1.5]	0.100 [2.54]	0.069 [1.75]

*NOTE: Female contacts feature Large Surface Area (L.S.A.) closed entry contact design which provides maximum mating surfaces between male and female contact and reduced contact resistance during operation.

REMOVABLE HIGH VOLTAGE CONTACT FOR USE WITH PCS MIXED DENSITY SERIES CONNECTORS CONTACTS MUST BE ORDERED SEPARATELY SIZE 8

Note: Connectors can be kitted with all applicable crimp/solder contacts, contact Technical Sales for connector part number.

STRAIGHT SOLDER WIRE TERMINATION

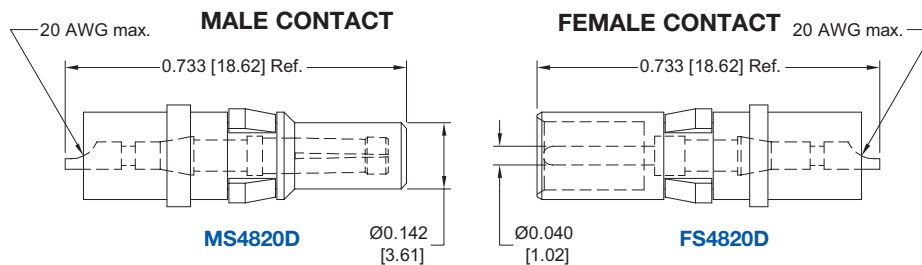

RIGHT ANGLE (90°) SOLDER WIRE TERMINATION

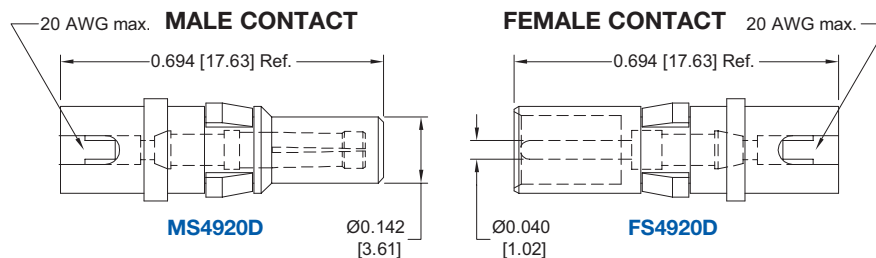

For information regarding CRIMP TOOLS & CRIMPING TOOL TECHNIQUES, see page 54.



Positronic
connectpositronic.com

CONTACT APPLICATION TOOLS CROSS REFERENCE LIST

Power
Connection
Systems

A P P L I C A T I O N T O O L S S E C T I O N

PLA (H), PLB (H), PLC (H) and PLS (H) connectors are offered with

***removable crimp contacts.** Positronic recognizes the*

***importance of** supplying **application tooling** to*

support our customers' use of our products.

Information on application tooling is

***available** on our web site at*

<http://www.connectpositronic.com/design-tools/tooling>

*There you will find **downloadable PDF** cross reference*

charts for removable and compliant press-in contacts. These charts

*will **supply part numbers** for insertion, removal and crimping tools,*

*along with **information regarding use** of tools and techniques.*



Connectors Designed To Customer Specifications

*Positronic's **PLA(H), PLB(H), PLC(H) and PLS(H)** series connectors can be modified to customers specifications.*

Examples: select loading of contacts for cost savings or to gain creepage and clearance distances; longer printed circuit board terminations; customer specified hardware.

Positronic can develop and tool new connector designs with reasonable price and delivery.

Contact Technical Sales with your particular requirements.

CONTACT APPLICATION TOOLS CROSS REFERENCE LIST

USE INDICATED POSITRONIC TOOLS FOR BEST RESULTS

PCS MIXED DENSITY	SAFTEY SHROUD & POWER INPUT				P C S S E R I E S																					
	SIZE 8 CONTACTS				SIZE 12 CONTACTS				SIZE 16 CONTACTS																	
	PC4104D	CC4103D	CC4102D	CC4101D	MS612N	MS612N-228.2	MS610NS	MS610NS-228.2	MS120N	MS112NS	MS11+N	MCS*26N	MC120N	MC112NS	MC11+N-133 *	MC11+N	FS120N2	FS112NS	FS11+N2	FCS*26N2	FC120N2	FC112NS	FC11+N2	FC11+N2		
9504-15-0-0	9504-15-0-0	9504-13-0-0	9504-14-0-0	9504-15-0-0	9504-19-0-0	9504-19-0-0	9504-19-0-0	9509-6-0-0	9509-6-0-0	9501-0-0-0	9506-0-0-0	9509-3-0-0	9509-3-0-0	9509-3-0-0	9501-0-0-0	9501-0-0-0	9501-0-0-0	9501-0-0-0	9506-0-0-0	9506-0-0-0	9506-0-0-0	9501-0-0-0	9501-0-0-0	9501-0-0-0	9501-0-0-0	
M22520/5-01	M22520/5-01	M22520/5-01	M22520/5-01	M22520/5-01	M22520/2-01	M22520/2-01	M22520/2-01	M22520/1-01	M22520/1-01	M22520/1-01	M22520/1-01	M22520/1-01	M22520/1-01	M22520/1-01	M22520/1-01	M22520/1-01	M22520/1-01	M22520/1-01	M22520/1-01	M22520/1-01	M22520/1-01	M22520/1-01	M22520/1-01	M22520/1-01	M22520/1-01	
9504-15-1-0	9504-15-1-0	9504-13-1-0	9504-14-1-0	9504-2-0-0	9502-22-0-0	9502-27-0-0	9502-27-0-0	9502-19-0-0	9502-19-0-0	9502-19-0-0	9506-2-0-0	9502-1-0-0	9509-5-0-0	9509-5-0-0	9502-17-0-0	9502-1-0-0	9502-1-0-0	9502-1-0-0	9506-2-0-0	9506-2-0-0	9506-2-0-0	9501-5-0-0	9501-5-0-0	9501-5-0-0	9501-5-0-0	9501-5-0-0
Y877	Y877	Y937	Y878	Y322	K1196	K1506	K1506	TP1199	TP1199	TP1199	TP1386	TP1386	TP1386	TP1386	TP1110	TH4	TH4	TH4	X530	TH4	TH4	TH4	TH4	TH4	TH4	TH4
M22520/5-01	M22520/5-01	M22520/5-01	M22520/5-01	M22520/5-01	M22520/2-01	M22520/2-01	M22520/2-01	M22520/1-01	M22520/1-01	M22520/1-01	M22520/1-03	M22520/1-03	M22520/1-03	M22520/1-03	M22520/1-03	M22520/1-03	M22520/1-03	M22520/1-03	M22520/1-03	M22520/1-03	M22520/1-03	M22520/1-03	M22520/1-03	M22520/1-03	M22520/1-03	
N/A	N/A	N/A	N/A	N/A	9099-4-0-0	9099-4-0-0	9099-4-0-0	9099-3-0-0	9099-3-0-0	9099-3-0-0	9099-0-0-0	9099-0-0-0	9099-0-0-0	9099-0-0-0	9099-0-0-0	9099-0-0-0	9099-0-0-0	9099-0-0-0	9099-0-0-0	9099-0-0-0	9099-0-0-0	9099-0-0-0	9099-0-0-0	9099-0-0-0	9099-0-0-0	9099-0-0-0
					TP1076	TP1076	TP1076	TP1168	TP1168	TP1168	TP1094	TP1094	TP1094	TP1094	TP1094	TP1094	TP1094	TP1094	TP1094	TP1094	TP1094	TP1094	TP1094	TP1094	TP1094	TP1094
					9081-2-0-0	9081-2-0-0	9081-2-0-0	9081-0-0-0	9081-0-0-0	9081-0-0-0	9081-0-0-0	9081-0-0-0	9081-0-0-0	9081-0-0-0	9081-0-0-0	9081-0-0-0	9081-0-0-0	9081-0-0-0	9081-0-0-0	9081-0-0-0	9081-0-0-0	9081-0-0-0	9081-0-0-0	9081-0-0-0	9081-0-0-0	
					RMG2103	RMG2103	RMG2103	RTG 2103	RTG 2103	RTG 2103	RTG 2103	RTG 2103	RTG 2103	RTG 2103	RTG 2103	RTG 2103	RTG 2103	RTG 2103	RTG 2103	RTG 2103	RTG 2103	RTG 2103	RTG 2103	RTG 2103	RTG 2103	
					9550-1-0-0	9550-1-0-0	9550-1-0-0	9550-0-0-0	9550-0-0-0	9550-0-0-0	9550-0-0-0	9550-0-0-0	9550-0-0-0	9550-0-0-0	9550-0-0-0	9550-0-0-0	9550-0-0-0	9550-0-0-0	9550-0-0-0	9550-0-0-0	9550-0-0-0	9550-0-0-0	9550-0-0-0	9550-0-0-0	9550-0-0-0	

To download a PDF file, visit our web site at http://www.connectpositronic.com/pdf_view/178

STOOL NOTATION

*1 All male and female crimp contacts can be ordered on reels in quantities of 2,000 by adding letter "R" after the contact part number, see page 57 for more information.



Positronic
connectpositronic.com

PRESS-IN USER INFORMATION AND CONNECTOR INSTALLATION TOOLING

Power
Connection
Systems

COMPLIANT PRESS-IN CONNECTOR INSTALLATION TOOLS

USE INDICATED POSITRONIC TOOLS FOR BEST RESULTS

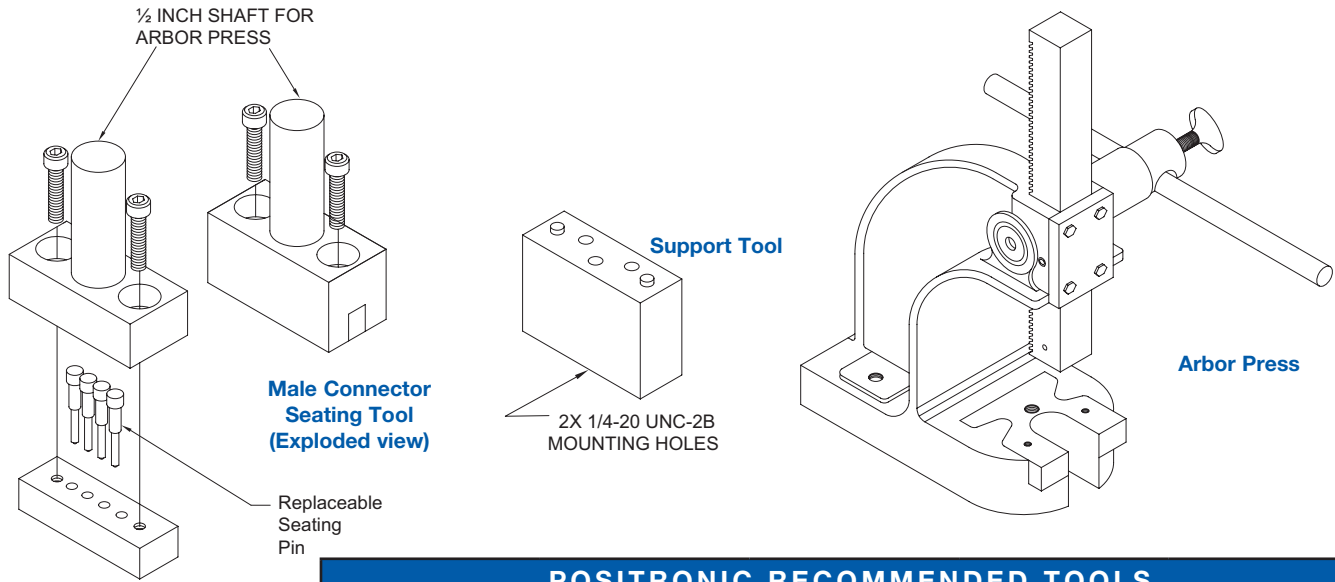

Female Connector Seating Tool (Exploded view)

Male Connector Seating Tool (Exploded view)

Replaceable Seating Pin

Support Tool

2X 1/4-20 UNC-2B MOUNTING HOLES

Arbor Press

POSITRONIC RECOMMENDED TOOLS

CONNECTOR VARIANT	CONNECTOR SEATING TOOL WITH ARBOR PRESS SHAFT		CONNECTOR SEATING TOOL WITHOUT ARBOR PRESS SHAFT	
	MALE	FEMALE	MALE	FEMALE
PLA03	9513-1-0-41	9513-13-0-41	9513-1-10-41	9513-13-10-41
PLA04	9513-2-0-41	9513-14-0-41	9513-2-10-41	9513-14-10-41
PLA06	9513-3-0-41	9513-15-0-41	9513-3-10-41	9513-15-10-41
PLA08	9513-4-0-41	9513-16-0-41	9513-4-10-41	9513-16-10-41
PLB06	9513-5-0-41	9513-17-0-41	9513-5-10-41	9513-17-10-41
PLB08	9513-6-0-41	9513-18-0-41	9513-6-10-41	9513-18-10-41
PLB10W2	9513-7-0-41	9513-30-0-41	9513-7-10-41	9513-30-10-41
PLB12	9513-7-0-41	9513-19-0-41	9513-7-10-41	9513-19-10-41
PLB16	9513-8-0-41	9513-20-0-41	9513-8-10-41	9513-20-10-41
PLB20	9513-33-0-41	9513-34-0-41	9513-33-10-41	9513-34-10-41
PLB3W3	9513-6-0-41	9513-18-1-41	9513-6-10-41	9513-18-11-41
PLC09	9513-9-0-41	9513-21-0-41	9513-9-10-41	9513-21-10-41
PLC12	9513-10-0-41	9513-22-0-41	9513-10-10-41	9513-22-10-41
PLC16W4	9513-11-0-41	9513-31-0-41	9513-11-10-41	9513-31-10-41
PLC18	9513-11-0-41	9513-23-0-41	9513-11-10-41	9513-23-10-41
PLC24	9513-12-0-41	9513-24-0-41	9513-12-10-41	9513-24-10-41
PLC30	9513-25-0-41	9513-26-0-41	9513-25-10-41	9513-26-10-41
Arbor press for connector seating tools: 9530-1-0-0 1 ton capacity 4 inch throat				
Replacement pins for connector seating tool	PCS Mixed Density Series Size 20		855-347-18-41	
	PCS Series Size 16		855-347-2-41 (female)	
	PLB3W3 Series Size 12		855-347-11-41 (female)	
	PCS Mixed Density Series Size 8		855-347-19-41	
Support tool for PLB3W3: 9513-401-6-41				

Positronic offers expert assistance in adapting application tooling to your manufacturing environment. Contact our application tooling specialist for assistance.

APPLICATION TOOLS

SUGGESTED PRINTED BOARD HOLE SIZES FOR COMPLIANT PRESS-IN CONNECTORS

Traditionally, tin-lead has been a popular plating for printed circuit boards (PCB) holes. However, many PCB hole platings must now be RoHS Compliant. Positronic is pleased to offer **PCB HOLE SIZE FOR RoHS** PCB plating as shown below.

OMEGA & BI-SPRING COMPLIANT PRESS-IN CONTACT HOLE				
BOARD TYPE	CONTACT SIZE / TYPE	RECOMMENDED DRILL HOLE SIZE	RECOMMENDED PLATING	FINISHED HOLE SIZES
TIN-LEAD SOLDER PCB	20 OMEGA	$\phi 0.0453 \pm 0.0010$ [$\phi 1.150 \pm 0.025$]	0.0006 [15 μ] minimum solder over 0.0010 [25 μ] min. copper	$\phi 0.0394 \pm 0.0035 - 0.0024$ [$\phi 1.000 \pm 0.090 - 0.060$]
	16 BI-SPRING	$\phi 0.069 \pm 0.001$ [$\phi 1.750 \pm 0.025$]		$\phi 0.0630 \pm 0.0035 - 0.0024$ [$\phi 1.600 \pm 0.090 - 0.060$]
	12 BI-SPRING	$\phi 0.102 \pm 0.001$ [$\phi 2.59 \pm 0.025$]		$\phi 0.096 \pm 0.002$ [$\phi 2.44 \pm 0.05$]
	8 BI-SPRING	$\phi 0.125 \pm 0.001$ [$\phi 3.180 \pm 0.025$]		$\phi 0.119 \pm 0.002$ [$\phi 3.02 \pm 0.05$]
RoHS PCB PLATING OPTIONS				
COPPER PCB	20 OMEGA	$\phi 0.047 \pm 0.001$ [$\phi 1.19 \pm 0.025$]	0.0010 [25 μ] min. copper	$\phi 0.043 \pm 0.002$ [$\phi 1.09 \pm 0.05$]
	16 BI-SPRING	$\phi 0.069 \pm 0.001$ [$\phi 1.750 \pm 0.025$]		$\phi 0.0630 \pm 0.0035 - 0.0024$ [$\phi 1.600 \pm 0.090 - 0.060$]
	12 BI-SPRING	$\phi 0.102 \pm 0.001$ [$\phi 2.59 \pm 0.025$]		$\phi 0.096 \pm 0.002$ [$\phi 2.44 \pm 0.05$]
	8 BI-SPRING	$\phi 0.125 \pm 0.001$ [$\phi 3.180 \pm 0.025$]		$\phi 0.119 \pm 0.002$ [$\phi 3.02 \pm 0.05$]
IMMERSION TIN PCB	20 OMEGA	$\phi 0.047 \pm 0.001$ [$\phi 1.19 \pm 0.025$]	0.000033 \pm 0.000006 [0.85 \pm 0.15 μ] immersion tin over 0.0010 [25 μ] min. copper	$\phi 0.043 \pm 0.002$ [$\phi 1.09 \pm 0.05$]
	16 BI-SPRING	$\phi 0.069 \pm 0.001$ [$\phi 1.750 \pm 0.025$]		$\phi 0.0630 \pm 0.0035 - 0.0024$ [$\phi 1.600 \pm 0.090 - 0.060$]
	12 BI-SPRING	$\phi 0.102 \pm 0.001$ [$\phi 2.59 \pm 0.025$]		$\phi 0.096 \pm 0.002$ [$\phi 2.44 \pm 0.05$]
	8 BI-SPRING	$\phi 0.125 \pm 0.001$ [$\phi 3.180 \pm 0.025$]		$\phi 0.119 \pm 0.002$ [$\phi 3.02 \pm 0.05$]
IMMERSION SILVER PCB	20 OMEGA	$\phi 0.047 \pm 0.001$ [$\phi 1.19 \pm 0.025$]	0.000013 \pm 0.000007 [0.34 \pm 0.17 μ] immersion silver over 0.0010 [25 μ] min. copper	$\phi 0.043 \pm 0.002$ [$\phi 1.09 \pm 0.05$]
	16 BI-SPRING	$\phi 0.069 \pm 0.001$ [$\phi 1.750 \pm 0.025$]		$\phi 0.0630 \pm 0.0035 - 0.0024$ [$\phi 1.600 \pm 0.090 - 0.060$]
	12 BI-SPRING	$\phi 0.102 \pm 0.001$ [$\phi 2.59 \pm 0.025$]		$\phi 0.096 \pm 0.002$ [$\phi 2.44 \pm 0.05$]
	8 BI-SPRING	$\phi 0.125 \pm 0.001$ [$\phi 3.18 \pm 0.025$]		$\phi 0.119 \pm 0.002$ [$\phi 3.02 \pm 0.05$]
ELECTROLESS NICKEL / IMMERSION GOLD PCB	20 OMEGA	$\phi 0.047 \pm 0.001$ [$\phi 1.19 \pm 0.025$]	0.000002 [0.05 μ] min. immersion gold over 0.000177 \pm 0.000059 [4.5 \pm 1.5 μ] electroless nickel per IPC-4552 over 0.0010 [25 μ] min. copper	$\phi 0.043 \pm 0.002$ [$\phi 1.09 \pm 0.05$]
	16 BI-SPRING	$\phi 0.069 \pm 0.001$ [$\phi 1.750 \pm 0.025$]		$\phi 0.0630 \pm 0.0035 - 0.0024$ [$\phi 1.600 \pm 0.090 - 0.060$]
	12 BI-SPRING	$\phi 0.102 \pm 0.001$ [$\phi 2.59 \pm 0.025$]		$\phi 0.096 \pm 0.002$ [$\phi 2.44 \pm 0.05$]
	8 BI-SPRING	$\phi 0.125 \pm 0.001$ [$\phi 3.180 \pm 0.025$]		$\phi 0.119 \pm 0.002$ [$\phi 3.02 \pm 0.05$]

“Omega” Termination
utilized on signal contacts



“Bi-Spring” Termination

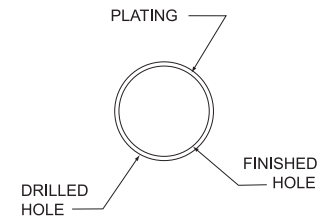

COMPLIANT PRESS-IN TERMINATION CONTACT HOLE

NOTE: For PCB plating compositions not shown, consult Technical Sales.

COMPLIANT PRESS-IN USER INFORMATION

When properly used, Positronic omega and bi-spring compliant press-in terminations provide reliable service even under severe conditions.

Connectors utilizing this leading technology compliant press-in contact are easy to install:

1. Inexpensive installation tooling is available from Positronic, to choose the proper installation tool refer to page 56 for part number ordering information.
2. Insert the connector into the P.C. board or backplane and seat connector fully.
3. Secure the connector to the P.C. board or backplane using two self-tapping screws. The screws should be #2 self-tapping screws for plastic.



RIGHT ANGLE (90°) METAL MOUNTING BRACKETS

CODE B ON STEP 5 OF ORDERING INFORMATION PAGE

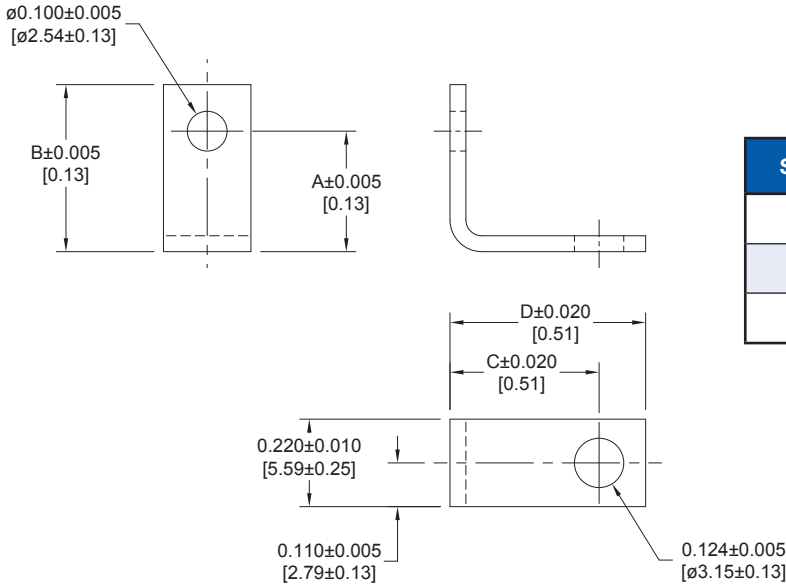

SERIES	A	B	C	D
PLA	0.204 [5.18]	0.321 [8.15]	0.375 [9.53]	0.492 [12.50]
PLB	0.303 [7.70]	0.420 [10.67]	0.375 [9.53]	0.492 [12.50]
PLC	0.401 [10.19]	0.518 [13.16]	0.375 [9.53]	0.492 [12.50]

MATERIAL: Brass, tin plate.

RIGHT ANGLE (90°) PLASTIC MOUNTING BRACKET WITH CROSS BAR

CODE B3 OR CODE B3N ON STEP 5 OF ORDERING INFORMATION PAGE

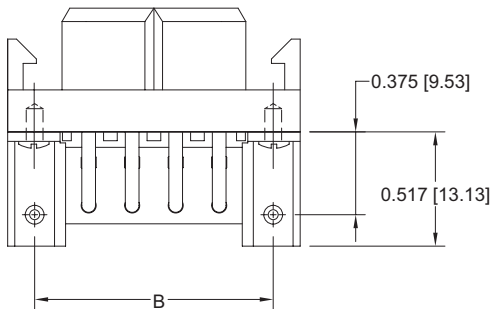

B3 style required
for right angle (90°)
press-in connectors

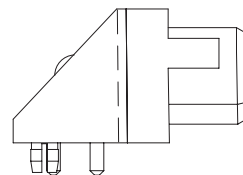
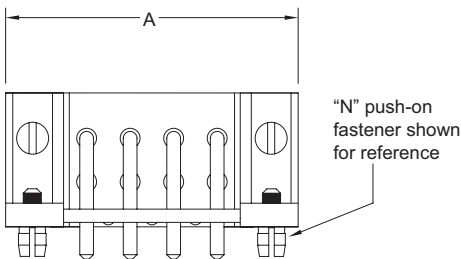

MATERIAL:
MOUNTING BRACKET/CROSS BAR: Glass filled polyester, UL 94V-0.
PUSH-ON FASTENERS: Copper alloy, tin plated.

CONNECTOR VARIANT	A	B
PLA03	1.126 [28.60]	0.882 [22.40]
PLA04	1.324 [33.63]	1.080 [27.43]
PLA06	1.718 [43.64]	1.474 [37.44]
PLA08	2.112 [53.64]	1.868 [47.45]
PLB06	1.126 [28.60]	0.882 [22.40]
PLB08	1.324 [33.63]	1.080 [27.43]
PLB12	1.718 [43.64]	1.474 [37.44]
PLB16	2.112 [53.64]	1.868 [47.45]
PLC09	1.126 [28.60]	0.882 [22.40]
PLC12	1.324 [33.63]	1.080 [27.43]
PLC18	1.718 [43.64]	1.474 [37.44]
PLC24	2.112 [53.64]	1.868 [47.45]
PLC30	2.506 [63.65]	2.262 [57.45]

PUSH-ON FASTENERS

CODE BN OR CODE N ON STEP 5 OF ORDERING INFORMATION PAGE

CODE BN

FOR USE WITH RIGHT ANGLE (90°) CONNECTOR

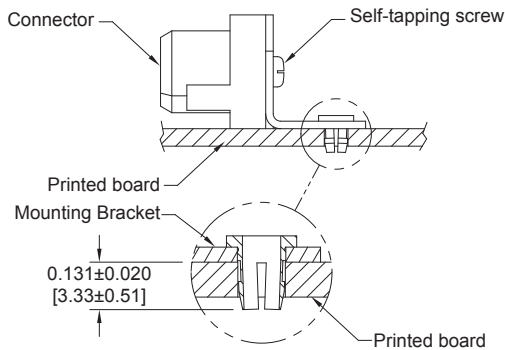

CODE N

FOR USE WITH STRAIGHT SOLDER CONNECTOR

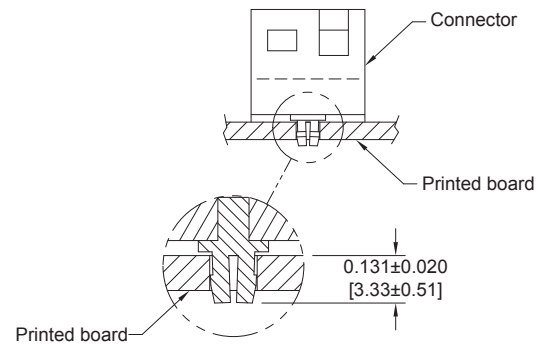

MATERIAL: Spring tempered copper alloy, tin plated.

SUGGESTED PRINTED BOARD HOLE SIZES:

Suggest 0.123 ±0.002 [3.12] Ø hole in printed board for mounting connector with push-on fasteners.

MOUNTING SCREWS

CODE ST2, ST3, ST4, SS2, SS3, OR SS4 ON STEP 5 OF ORDERING INFORMATION PAGE

**NOTE: MOUNTING SCREWS FOR RIGHT ANGLE CONNECTORS ARE ORDERED SEPARATELY
USING PART NUMBERS SHOWN IN CHART BELOW.**

Stresses that occur during coupling and uncoupling of connectors or through shock and vibration of systems can be transferred to backplanes or P.C. boards through press-in connector terminations. Avoid concern over electrical integrity of the connector to board interface by using mounting screws. Bellcore GR1217 details a preference for the use of mounting hardware and we recommend this practice.

SCREWS ARE #2 SELF-TAPPING FOR PLASTIC.

MOUNTING STYLE OPTION	MATERIAL OPTIONS	PART NUMBER	THREAD LENGTH	P.C. BOARED THICKNESS
ST2	STEEL	A4546-7-1-97	0.250±0.030 [6.35±0.76]	0.093 [2.36]
ST3	STEEL	A4546-7-2-97	0.312±0.030 [7.93±0.76]	0.125 [3.18]
ST4	STEEL	A4546-7-3-97	0.375±0.030 [9.53±0.76]	0.175 [4.45]
SS2	STAINLESS STEEL	A4546-7-6-4	0.250±0.030 [6.35±0.76]	0.093 [2.36]
SS3	STAINLESS STEEL	A4546-7-7-4	0.312±0.030 [7.93±0.76]	0.125 [3.18]
SS4	STAINLESS STEEL	A4546-7-8-4	0.375±0.030 [9.53±0.76]	0.175 [4.45]

CONSULT TECHNICAL SALES IF AN ALTERNATE SCREW IS REQUIRED.

DIMENSIONS ARE IN INCHES [MILLIMETERS].
ALL DIMENSIONS ARE SUBJECT TO CHANGE.



POWER CONNECTION SYSTEMS HOOD

CODE 5 ON STEP 6 OF ORDERING INFORMATION PAGE

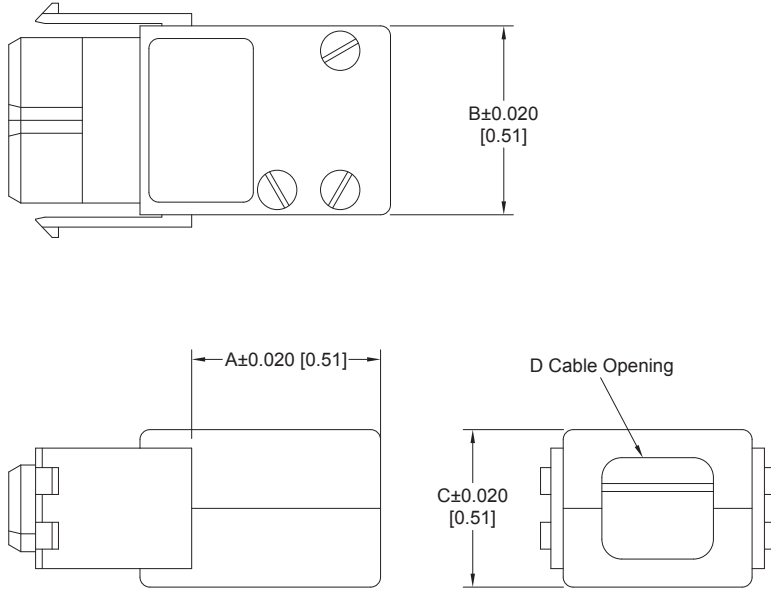

Features internal cable clamp.

CONNECTOR VARIANT	A	B	C	D	
PLA03	1.000 [25.40]	0.752 [19.10]	0.594 [15.09]	0.312 [7.92]	0.363 [9.22]
PLA04	1.000 [25.40]	0.950 [24.13]	0.594 [15.09]	0.312 [7.92]	0.561 [14.25]
PLA06	1.000 [25.40]	1.344 [34.14]	0.594 [15.09]	0.312 [7.92]	0.955 [24.26]
PLA08	1.000 [25.40]	1.738 [44.15]	0.594 [15.09]	0.312 [7.92]	1.349 [34.26]
PLB06	1.000 [25.40]	0.752 [19.10]	0.792 [20.12]	0.510 [12.95]	0.363 [9.22]
PLB08	1.000 [25.40]	0.950 [24.13]	0.792 [20.12]	0.510 [12.95]	0.561 [14.25]
PLB12	1.000 [25.40]	1.344 [34.14]	0.792 [20.12]	0.510 [12.95]	0.955 [24.26]
PLB16	1.000 [25.40]	1.738 [44.15]	0.792 [20.12]	0.510 [12.95]	1.349 [34.26]
PLB3W3	1.000 [25.40]	0.950 [24.13]	0.792 [20.12]	0.510 [12.95]	0.561 [14.25]
PLC09	1.000 [25.40]	0.752 [19.10]	0.990 [25.15]	0.708 [17.98]	0.363 [9.22]
PLC12	1.000 [25.40]	0.950 [24.13]	0.990 [25.15]	0.708 [17.98]	0.561 [14.25]
PLC18	1.000 [25.40]	1.344 [34.14]	0.990 [25.15]	0.708 [17.98]	0.955 [24.26]
PLC24	1.000 [25.40]	1.738 [44.15]	0.990 [25.15]	0.708 [17.98]	1.349 [34.26]
PLC30	1.000 [25.40]	2.132 [54.15]	0.990 [25.15]	0.708 [17.98]	1.743 [44.27]

HOOD FOR USE WITH PLS5W5 CONNECTOR

CODE 5 ON STEP 6 OF ORDERING INFORMATION PAGE

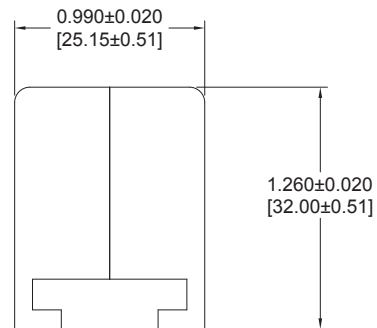
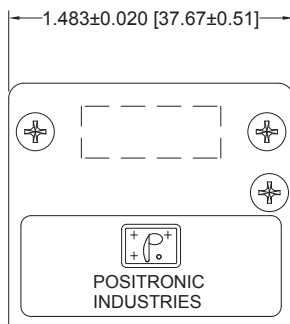

For PLS5W5
Connector Only

Features internal cable clamp.

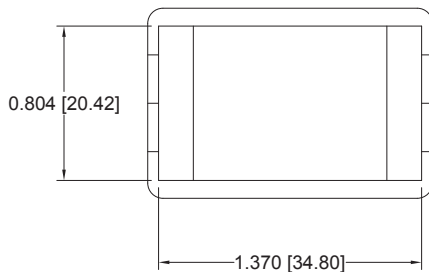

CONTACT TECHNICAL SALES
FOR AVAILABILITY OF 7W7 VARIANT.

PANEL MOUNT CONNECTORS WITH QUICK RELEASE MOUNTING CLIP

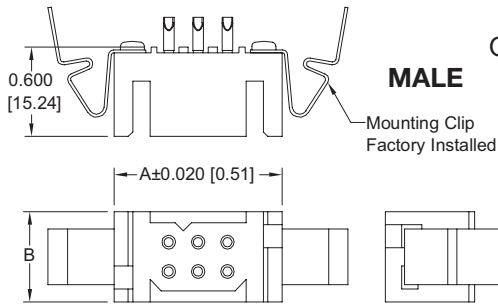

CODE 6 IN STEP 6 OF
ORDERING INFORMATION PAGE

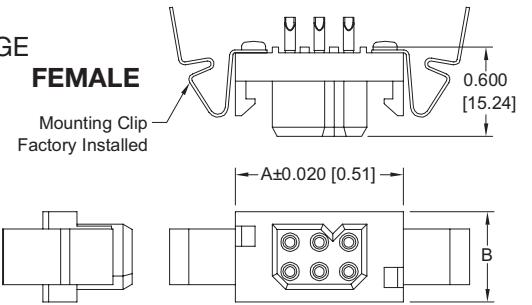

For connection system 8

Typical part number: PLB06M206C1

Typical part number: PLB06F206C1

CONNECTOR VARIANTS	A	B
PLA03	1.126 [28.60]	0.408 [10.36]
PLA04	1.324 [33.63]	0.408 [10.36]
PLA06	1.718 [43.64]	0.408 [10.36]
PLA08	2.112 [53.64]	0.408 [10.36]
PLB06	1.126 [28.60]	0.606 [15.39]
PLB08	1.324 [33.63]	0.606 [15.39]
PLB12	1.718 [43.64]	0.606 [15.39]

CONNECTOR VARIANTS	A	B
PLB16	2.112 [53.64]	0.606 [15.39]
PLB20	2.506 [63.65]	0.606 [15.39]
PLC09	1.126 [28.60]	0.802 [30.37]
PLC12	1.324 [33.63]	0.802 [30.37]
PLC18	1.718 [43.64]	0.802 [30.37]
PLC24	2.112 [53.64]	0.802 [30.37]
PLC30	2.506 [63.65]	0.802 [30.37]

PANEL MOUNT CONNECTORS WITH QUICK RELEASE MOUNTING CLIP FOR REMOVABLE CONTACTS

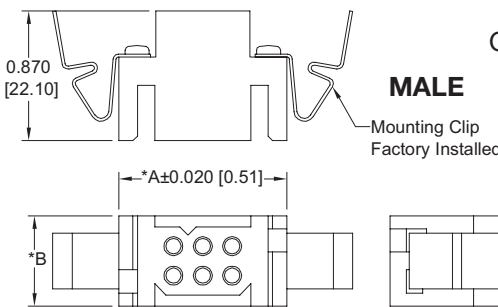

CODE 6 IN STEP 6 OF
ORDERING INFORMATION PAGE

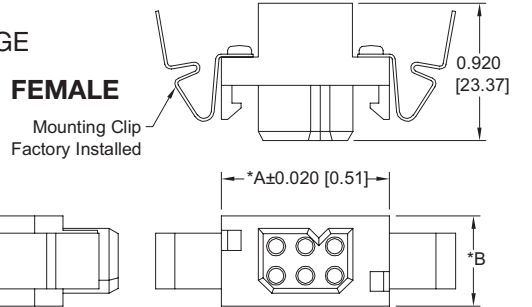

For connection system 8

*Note: See chart
above for connector
dimensions.

Typical part number: PLB06M1060

Typical part number: PLB06F1060

CONNECTOR VARIANTS	A	B	C
PLA03	1.600 [40.64]	1.168 [29.67]	0.445 [11.30]
PLA04	1.798 [45.67]	1.366 [34.70]	0.445 [11.30]
PLA06	2.192 [55.68]	1.760 [44.70]	0.445 [11.30]
PLA08	2.586 [65.68]	2.154 [54.71]	0.445 [11.30]
PLB06	1.600 [40.64]	1.168 [29.67]	0.643 [16.33]
PLB08	1.798 [45.67]	1.366 [34.70]	0.643 [16.33]
PLB12	2.192 [55.68]	1.760 [44.70]	0.643 [16.33]
PLB16	2.586 [65.68]	2.154 [54.71]	0.643 [16.33]
PLB20	2.980 [75.69]	2.548 [64.72]	0.643 [16.33]
PLC09	1.600 [40.64]	1.168 [29.67]	0.839 [21.31]
PLC12	1.798 [45.67]	1.366 [34.70]	0.839 [21.31]
PLC18	2.192 [55.68]	1.760 [44.70]	0.839 [21.31]
PLC24	2.586 [65.68]	2.154 [54.71]	0.839 [21.31]
PLC30	2.980 [75.69]	2.548 [64.72]	0.839 [21.31]

PANEL CUTOUT FOR USE WITH QUICK RELEASE MOUNTING CLIPS

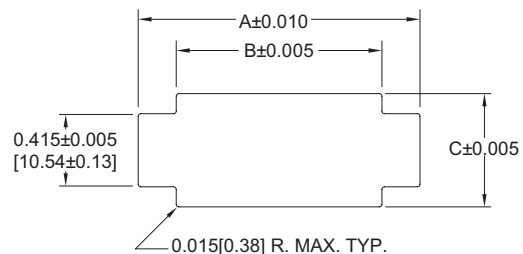

Maximum panel thickness: 0.063 [1.60] nominal.

DIMENSIONS ARE IN INCHES [MILLIMETERS].
ALL DIMENSIONS ARE SUBJECT TO CHANGE.



PANEL MOUNT CONNECTORS WITH *FIXED STYLE MOUNTING CLIP

CODE 81, 82 AND 83 IN STEP 6 OF ORDERING INFORMATION PAGE

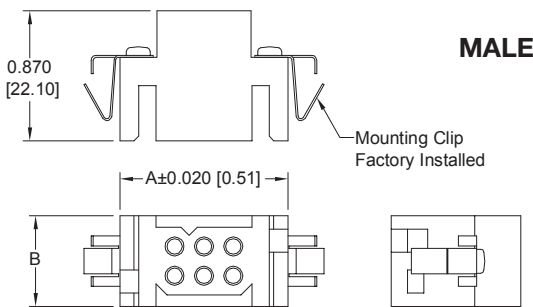

Typical part number:
PLB06M10810

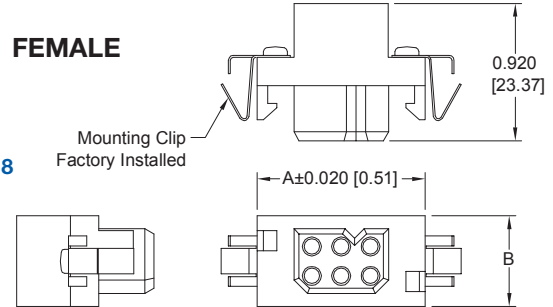

Typical part number:
PLB06F10810

For connection system 8

CLIP MATERIAL: Beryllium copper, nickel plated

PART NUMBER	PANEL THICKNESS
PL*****81*	0.040 [1.02]
PL*****82*	0.060 [1.52]
PL*****83*	0.090 [2.29]

* May be used with either fixed solder or removable contact connector insulators.

CONNECTOR VARIANTS	A	B
PLA03	1.126 [28.60]	0.408 [10.36]
PLA04	1.324 [33.63]	0.408 [10.36]
PLA06	1.718 [43.64]	0.408 [10.36]
PLA08	2.112 [53.64]	0.408 [10.36]
PLB06	1.126 [28.60]	0.606 [15.39]
PLB08	1.324 [33.63]	0.606 [15.39]
PLB12	1.718 [43.64]	0.606 [15.39]
PLB16	2.112 [53.64]	0.606 [15.39]
PLB20	2.506 [63.65]	0.606 [15.39]
PLC09	1.126 [28.60]	0.802 [30.37]
PLC12	1.324 [33.63]	0.802 [30.37]
PLC18	1.718 [43.64]	0.802 [30.37]
PLC24	2.112 [53.64]	0.802 [30.37]
PLC30	2.506 [63.65]	0.802 [30.37]

PANEL CUTOUT FOR USE WITH FIXED STYLE MOUNTING CLIPS

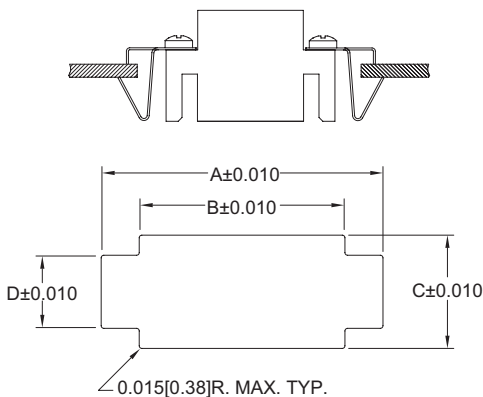

CONNECTOR VARIANTS	A	B	C	D
PLA03	1.380 [35.05]	1.150 [29.21]	0.445 [11.30]	0.193 [4.90]
PLA04	1.578 [40.08]	1.348 [34.24]	0.445 [11.30]	0.193 [4.90]
PLA06	1.972 [50.09]	1.742 [44.25]	0.445 [11.30]	0.193 [4.90]
PLA08	2.366 [60.10]	2.136 [54.25]	0.445 [11.30]	0.193 [4.90]
PLB06	1.380 [35.05]	1.150 [29.21]	0.643 [16.33]	0.300 [7.62]
PLB08	1.578 [40.08]	1.348 [34.24]	0.643 [16.33]	0.300 [7.62]
PLB12	1.972 [50.09]	1.742 [44.25]	0.643 [16.33]	0.300 [7.62]
PLB16	2.366 [60.10]	2.136 [54.25]	0.643 [16.33]	0.300 [7.62]
PLB20	2.760 [70.10]	2.530 [64.26]	0.643 [16.33]	0.300 [7.62]
PLC09	1.380 [35.05]	1.150 [29.21]	0.839 [21.31]	0.300 [7.62]
PLC12	1.578 [40.08]	1.348 [34.24]	0.839 [21.31]	0.300 [7.62]
PLC18	1.972 [50.09]	1.742 [44.25]	0.839 [21.31]	0.300 [7.62]
PLC24	2.366 [60.10]	2.136 [54.25]	0.839 [21.31]	0.300 [7.62]
PLC30	2.760 [70.10]	2.530 [64.26]	0.839 [21.31]	0.300 [7.62]

PANEL MOUNT CUTOUT

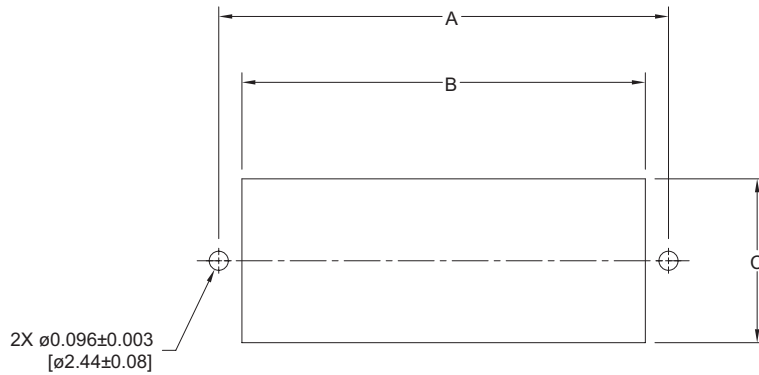

CONNECTOR VARIANTS	A ± 0.005	B ± 0.005	C ± 0.005
PLA03	0.882 [22.40]	0.650 [16.51]	0.430 [10.92]
PLA04	1.079 [27.41]	0.847 [21.51]	0.430 [10.92]
PLA06	1.473 [37.41]	1.241 [31.52]	0.430 [10.92]
PLA08	1.867 [47.42]	1.635 [41.53]	0.430 [10.92]
PLB06	0.882 [22.40]	0.650 [16.51]	0.627 [15.93]
PLB08	1.079 [27.41]	0.847 [21.51]	0.627 [15.93]
PLB12	1.473 [37.41]	1.241 [31.52]	0.627 [15.93]
PLB16	1.867 [47.42]	1.635 [41.53]	0.627 [15.93]
PLB20	2.262 [57.45]	2.029 [51.54]	0.627 [15.93]
PLB3W3	1.079 [27.41]	0.847 [21.51]	0.627 [15.93]
PLB10W2	1.473 [37.41]	1.241 [31.52]	0.627 [15.93]
PLC09	0.882 [22.40]	0.650 [16.51]	0.824 [20.93]
PLC12	1.079 [27.41]	0.847 [21.51]	0.824 [20.93]
PLC18	1.473 [37.41]	1.241 [31.52]	0.824 [20.93]
PLC24	1.867 [47.42]	1.635 [41.53]	0.824 [20.93]
PLC30	2.262 [57.45]	2.029 [51.54]	0.824 [20.93]
PLC16W4	1.473 [37.41]	1.241 [31.52]	0.824 [20.93]



BLIND MATING SYSTEM CODE 11, 12, 13 AND 14 IN STEP 6 OF ORDERING INFORMATION PAGE

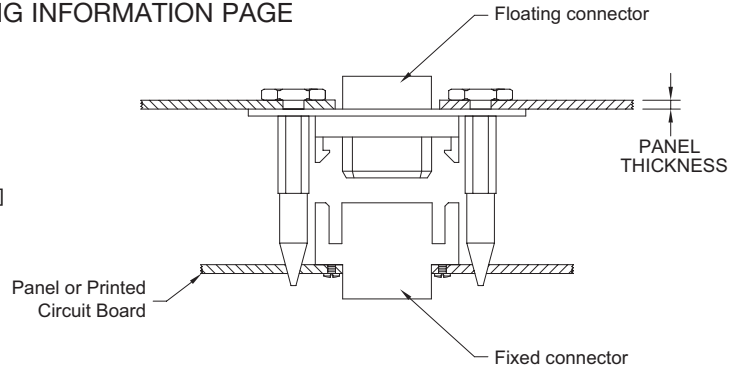
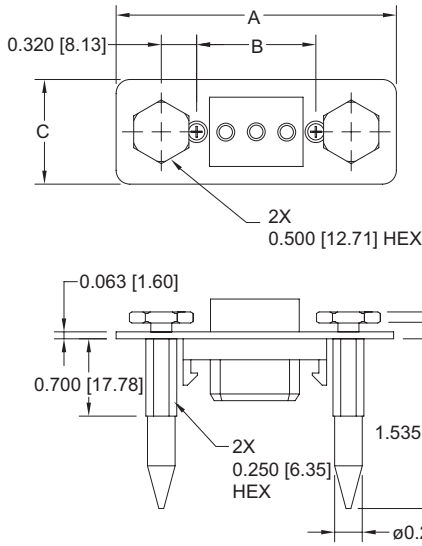

Typical Part Number: **PLB08F10120**

PANEL CUTOUT

FOR USE WITH FLOATING AND FIXED CONNECTOR BLIND MATING SYSTEMS

FLOATING CONNECTOR

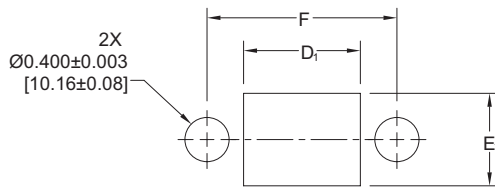

FIXED CONNECTOR

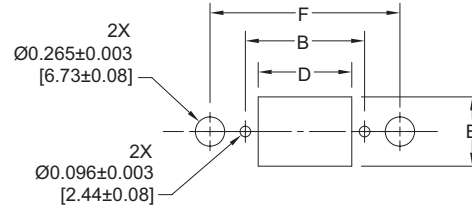

NOTE: Panel thickness may impact the orientation of mating end of blind mate pin. Shimming between the panel and the head of the blind mate pin may be necessary to minimize tilt of the blind mate system. Contact technical sales for additional technical information.

MATERIALS AND FINISHES:

- BLIND MATING PLATE:** Stainless steel.
- BLIND MATING GUIDE:** Stainless steel, passivated.
- FLOAT SCREW:** Steel, zinc plate with chromate seal.

Blind mating system provides lead in for 0.100 [2.54] axial misalignment.

Blind mating system sold in a kit containing a connector - plate assembly, Blind mating guides, and float screws.

CONNECTOR VARIANTS	A	B ±0.005	C	D ±0.005	D ₁ ±0.005	E ±0.005	E ₁ ±0.005	F ±0.005
PLA03	2.340 [59.44]	0.882 [22.40]	0.750 [19.05]	0.650 [16.51]	0.860 [21.84]	0.430 [10.92]	0.640 [16.26]	1.522 [38.66]
PLA04	2.537 [64.44]	1.079 [27.41]	0.750 [19.05]	0.847 [21.51]	1.057 [26.85]	0.430 [10.92]	0.640 [16.26]	1.719 [43.66]
PLA06	2.931 [74.45]	1.473 [37.41]	0.750 [19.05]	1.241 [31.52]	1.451 [36.86]	0.430 [10.92]	0.640 [16.26]	2.113 [53.67]
PLA08	3.325 [84.46]	1.867 [47.42]	0.750 [19.05]	1.635 [41.53]	1.845 [46.86]	0.430 [10.92]	0.640 [16.26]	2.507 [63.68]
PLB06	2.340 [59.44]	0.882 [22.40]	0.947 [24.05]	0.650 [16.51]	0.860 [21.84]	0.627 [15.93]	0.837 [21.26]	1.522 [38.66]
PLB08	2.537 [64.44]	1.079 [27.41]	0.947 [24.05]	0.847 [21.51]	1.057 [26.85]	0.627 [15.93]	0.837 [21.26]	1.719 [43.66]
PLB12	2.931 [74.45]	1.473 [37.41]	0.947 [24.05]	1.241 [31.52]	1.451 [36.86]	0.627 [15.93]	0.837 [21.26]	2.113 [53.67]
PLB16	3.325 [84.46]	1.867 [47.42]	0.947 [24.05]	1.635 [41.53]	1.845 [46.86]	0.627 [15.93]	0.837 [21.26]	2.507 [63.68]
PLB3W3	2.537 [64.44]	1.079 [27.41]	0.947 [24.05]	0.847 [21.51]	1.057 [26.85]	0.627 [15.93]	0.837 [21.26]	1.719 [43.66]
PLC09	2.340 [59.44]	0.882 [22.40]	1.144 [29.06]	0.650 [16.51]	0.860 [21.84]	0.824 [20.93]	1.034 [26.26]	1.522 [38.66]
PLC12	2.537 [64.44]	1.079 [27.41]	1.144 [29.06]	0.847 [21.51]	1.057 [26.85]	0.824 [20.93]	1.034 [26.26]	1.719 [43.66]
PLC18	2.931 [74.45]	1.473 [37.41]	1.144 [29.06]	1.241 [31.52]	1.451 [36.86]	0.824 [20.93]	1.034 [26.26]	2.113 [53.67]
PLC24	3.325 [84.46]	1.867 [47.42]	1.144 [29.06]	1.635 [41.53]	1.845 [46.86]	0.824 [20.93]	1.034 [26.26]	2.507 [63.68]
PLC30	3.720 [94.49]	2.262 [57.45]	1.144 [29.06]	2.029 [51.54]	2.239 [56.87]	0.824 [20.93]	1.034 [26.26]	2.902 [73.71]

PART NUMBER	PANEL THICKNESS
PL****11* PLB3W3*10110	0.040 [1.02]
PL****12* PLB3W3*10120	0.060 [1.52]
PL****13* PLB3W3*10130	0.090 [2.28]
PL****14* PLB3W3*10140	0.120 [3.05]

Connector Excellence[®]

Positronic HIGH RELIABILITY Products

POWER

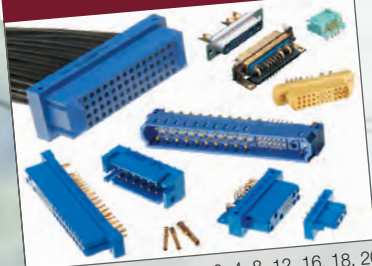

FEATURES:

- High current density
- Energy saving - low contact resistance
- AC/DC operation in a single connector
- Signal contacts for hardware management
- Blind mating
- Sequential mating
- Large surface area contact mating system
- Wide variety of accessories
- Customer-specified contact arrangements
- Modular tooling which produces a single piece connector insert

Contact Sizes: 0, 4, 8, 12, 16, 18, 20, 22 and 24

Current Ratings: To 200 amperes per contact

Terminations: Crimp and fixed cable connector, straight solder, right angle (90°) solder, straight compliant press-in and right angle (90°) compliant press-in

Configurations: Multiple variants in a variety of package sizes

Compliance: PICMG 2.11, PICMG 3.0, VITA 41, DSCC, GSFC S-311-P-4, GSFC S-311-P-10

D - SUB MINIATURE



FEATURES:

- Four performance levels available for best cost/performance ratio: professional, industrial, military and space-flight quality
- Options include high voltage, coax, thermocouple and air coupling contacts; environmentally sealed and dual port connector packages including mixed density
- Broad selection of accessories
- Size 20 and 22 contacts suitable for use in carrying power
- IP65, IP67

Contact Sizes: 8, 16, 20 and 22

Current Ratings: To 100 amperes

Terminations: Crimp, wire solder, straight solder, right angle (90°) compliant press-in and right angle (90°) compliant press-in

Configurations: Multiple variants in both standard and high densities, seven connector housing sizes

Qualifications: MIL-DTL-24308, GSFC S-311-P-4, GSFC S-311-P-10, AS39029, DSCC

RECTANGULAR



FEATURES:

- Two performance levels available: industrial quality and military quality
- A wide variety of accessories
- Broad selection of contact arrangement and package sizes
- Connector coding device (keying) options

Contact Sizes: 16, 20 and 22

Current Ratings: To 13 amperes nominal

Terminations: Crimp, wire solder, straight solder, right angle (90°) solder, and straight compliant press-in

Configurations: Multiple variants in both standard and high densities, thirty package sizes

Qualifications: MIL-DTL-28748, AS39029, CCITT V.35

CIRCULAR



FEATURES:

- Non-corrodible / lightweight composite construction
- EMI/RFI shielded versions
- Thermocouple contacts
- Environmentally sealed versions
- Rear insertion/ front release of removable contacts
- Two level sequential mating
- Overmolding available on full assemblies

Contact Sizes: 12, 16, 20 and 22

Current Ratings: To 25 amperes nominal

Terminations: Crimp, wire solder, straight solder, and right angle (90°) solder

Configurations: Multiple variants in four package sizes

Qualifications: Environmental protection to IP67

HERMETIC



FEATURES:

- Intended for use as an electrical feedthrough in high vacuum applications
- Helium leakage rate at ambient temperature: $< 5 \times 10^{-9}$ mbar.l/s under a vacuum 1.5×10^{-2} mbar
- Signal, power, coax and high voltage versions available
- Connectors can be mounted on flange assembly per customer specification

Contact Sizes: 8, 12, 16, 20 and 22

Current Ratings: To 40 amperes nominal

Terminations: Feedthrough is standard; flying leads and board mount available upon request

Configurations: See D-subminiature and circular configurations above

Compliance: Space-D32

For more information, visit www.connectpositronic.com or call your nearest Positronic sales office listed on the back of this catalog.



Positronic®

THE SCIENCE OF CERTAINTY

Divisional Headquarters

Positronic | Americas

423 N Campbell Ave
Springfield MO 65806 USA

+1 800 641 4054
info@connectpositronic.com

Positronic | Europe

Z.I. d'Engachies
46, route d'Engachies
F-32020 Auch Cedex 9 France

+33 5 6263 4491
contact@connectpositronic.com

Positronic | Asia

3014A Ubi Rd 1 #07-01
Singapore 408703

+65 6842 1419
singapore@connectpositronic.com

Sales Offices

Positronic has local sales representation all over the world. To find the nearest sales office, please visit www.connectpositronic.com/sales

LOCATIONS

www.connectpositronic.com

X-ON Electronics

Largest Supplier of Electrical and Electronic Components

Click to view similar products for [D-Sub Contacts](#) category:

Click to view products by [Positronic](#) manufacturer:

Other Similar products are found below :

[D02-22-26S-10000](#) [8656352067LF](#) [124C10019X](#) [131A11039X](#) [131J21029X](#) [131J21039X](#) [132J22039X](#) [1757912-1](#) [1757913-1](#) [030-50634](#)
[053744-0098](#) [601098N003](#) [162A11819X](#) [1-208778-5](#) [MC7526D/AA](#) [FC4010D-15](#) [FC4006D](#) [121A05329A](#) [D*C-20-22P-PKG100](#)
[164C12969X](#) [09692825723](#) [CUC-DSC-J1BAU-S/DSC22](#) [030-1954-000](#) [131C11129X](#) [L17DM53744206](#) [L17DM53744207](#) [L17DM53744-6](#)
[L17RRD1M11400](#) [030-1952-000](#) [030-1955-000](#) [09692817823](#) [FMP003S106](#) [9560008277](#) [030-1953-000](#) [030-1953-030](#) [162A18419X](#)
[09670003672](#) [09670007166](#) [09692815422](#) [162A18719X](#) [FMP003P106](#) [132C11039X](#) [132A15019X](#) [132J15019X](#) [132C15019X](#) [132C11019X](#)
[132A10039X](#) [131A10029X](#) [D*C-20-22S-PKG100](#) [8638PSC2006LF](#)