

HIGH DENSITY RECTANGULAR

Rectangular Connectors



Positronic®

THE SCIENCE OF CERTAINTY

Qualified to:

MIL-C-28748/13 & MIL-C-28748/14

MIL-DTL-28748/7 & MIL-DTL-28748/8

SAE AS39029/34-440 & SAE AS39029/35-441

C-008 Rev. F1

Positronic Provides Complete Capability

Experience

- Founded in **1966**
- **Involvement** in the development of international connector specifications through EIA®, IEC and ISO as well as PICMG®.
- Introduction of new and **unique connector products** to the electronics industry.
- Patent holder for many **unique connector features and manufacturing techniques**.
- **Vertically integrated** manufacturing – raw materials to finished connectors.

Technology

- **Expertise** with solid machined contacts provides a variety of high reliability connectors including high current density power connectors.
- Quality Assurance lab is **capable of testing** to IEC, EIA, UL, CUL, military and customer-specified requirements.
- **In-house design and development** of connectors based on market need or individual customer requirements.
- **Internal manufacturing capabilities** include automatic precision contact machining, injection molding, stamping, plating operations and connector assembly.
- **Manufacturing locations** in southwest Missouri, U.S.A. (headquarters); France, China, Singapore, and India.

Support

- **Quality Systems:** Select locations qualified to ISO 9001, ISO 14001, AS9100, MIL-STD-790 and customer “dock to stock” programs. Applicable products qualified to MIL-DTL-24308, SAE AS39029, DSCC 85039, MIL-DTL-28748, Space D32, GSFC S-311-P-4 and GSFC S-311-P-10.
- Compliance to a variety of international and customer specific **environmental requirements**.
- Large **in-house inventory** of finished connectors. Customer specific **stocking programs**.
- Factory direct **technical sales support** in major cities worldwide.
- **One-on-one customer support** from worldwide factory locations.
- World class **web site**.
- **Value-added solutions** and willingness to **develop custom products** with reasonable price and delivery.

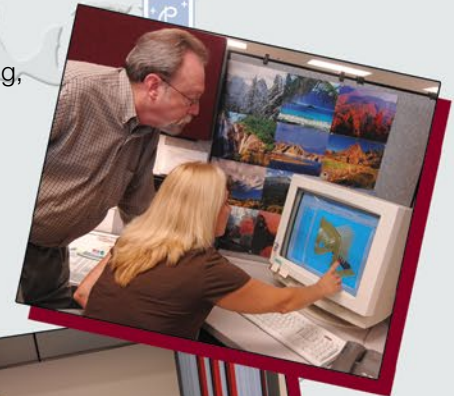

Manufacturing Facilities

Springfield, MO



Auch, France



Singapore



Products described within this catalog may be protected by one or more of the following US patents:

#4,900,261* #5,255,580 #5,329,697 #6,260,268
#6,835,079 #7,115,002 #8,944,697 #9,304,263

* Patented in Canada, 1992 Other Patents Pending

Positronic Industries' **FEDERAL SUPPLY CODE** (Cage Code)
FOR MANUFACTURERS is **28198**

Unless otherwise specified, **dimensional tolerances** are:

- 1) ± 0.001 inches [0.03 mm] for male contact mating diameters.
- 2) ± 0.003 inches [0.08 mm] for contact termination diameters.
- 3) ± 0.005 inches [0.13 mm] for all other diameters.
- 4) ± 0.015 inches [0.38 mm] for all other dimensions.

POSITRONIC® IS AN ITAR REGISTERED COMPANY

Information in this catalog is proprietary to Positronic and its subsidiaries. Positronic believes the data contained herein to be reliable. Since the technical information is given free of charge, the user employs such information at his own discretion and risk. Positronic assumes no responsibility for results obtained or damages incurred from use of such information in whole or in part.

The following trademarks are owned by Positronic Industries, Inc.: Positronic Industries, Inc.®, Positronic®, Connector Excellence®, P+ logo®, PosiBand®, PosiShop®, Optik-D™, and The Science of Certainty®. The color blue as it appears on various connectors is a trademark of Positronic Industries, Inc., Registered in U.S. Patent and Trademark Office.

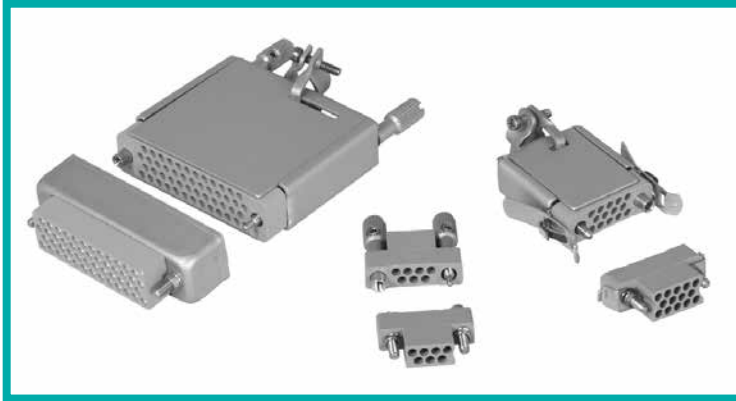

SGMC SERIES

High density rectangular connectors with size 22 removable contacts. Industrial performance or MIL-C-28748/13, MIL-C-28748/14, SAE AS39029/34 and SAE AS39029/35. Eleven connector variants, 4 through 104 contacts. Crimp, solder cup, straight solder and compliant press-in printed board mount terminations. Thermocouple contact options available.

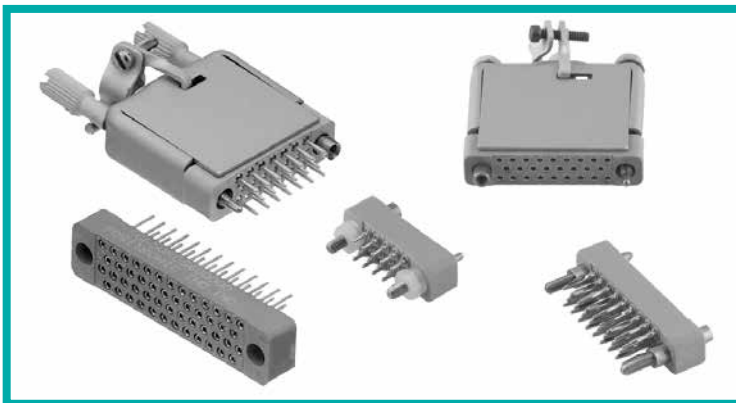

SGM SERIES

High density rectangular connectors with size 22 straight printed circuit board mount / solder cup contacts. Industrial performance or MIL-DTL-28748/7 and MIL-DTL-28748/8. Twelve connector variants, 4 through 50 contacts. Solder cup, wrap post, straight solder and compliant press-in printed board mount terminations. Thermocouple contact options available.

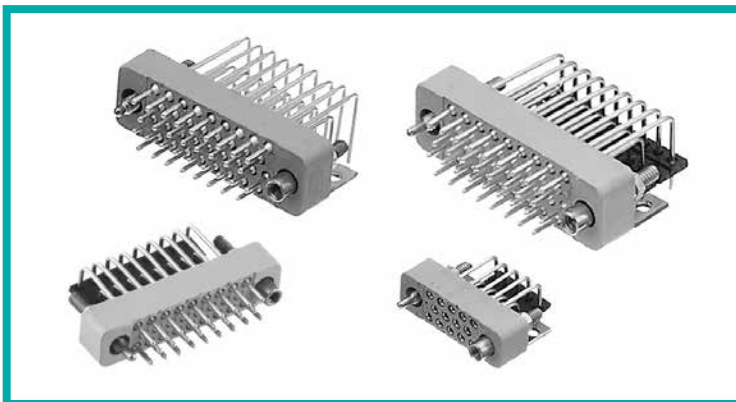

SMPL SERIES

High density rectangular connectors with size 22 right angle printed circuit board mount contacts. Industrial performance or conformance to MIL-DTL-28748. Twelve connector variants, 4 through 50 contacts. Right angle (90°) solder printed board mount terminations. Thermocouple contact options available.

Visit our website for the latest catalog updates and supplements at
<https://www.connectpositronic.com/catalogs/>



RoHS Compliant
options available!



G E N E R A L I N F O R M A T I O N

What makes Positronic's new "PosiBand®" contact interface a significant improvement?	1
The PosiBand® contact system has many advantages over the legacy split tine design	2
Temperature Rise Curves	2
Mating Dimensions and Exploded View of Typical Mated Connector Assemblies	3
Connector Component Description and Terminology	4

S G M C S E R I E S

Technical Characteristics	5-6
Connector Insert Dimensions	7-8
Contact Hole Dimensions and Printed Board Hole Pattern for Contact Variants 75 and 104	8
Removable Contact Ordering Assistance Chart	9
Ordering Information	10

R E M O V A B L E C O N T A C T S

Technical Characteristics	11
Size 22 Removable Crimp Contact	11
Size 22 Removable Military Crimp Contact	12
Size 22 Removable Thermocouple Crimp Contact	12
Size 22 Removable Solder Cup Contact	13
Size 22 Removable Straight Solder Printed Board Mount Contact	13
Size 22 Removable Compliant Press-In Printed Board Mount Contact	14
Mounting Hardware for Printed Board Mount Connectors	14

S G M S E R I E S

Technical Characteristics	15-16
Connector Insert Dimensions for SGM and SMPL Series	17-18
Straight Solder Printed Board Mount Termination	18
Solder Cup Termination	19
Wrap Post Termination	20
Compliant Press-In Printed Board Mount Termination	20
Contact Hole Dimensions and Printed Board Hole Pattern for SGM and SGMC Series	21
Ordering Information	22

S M P L S E R I E S

Technical Characteristics	23-24
Right Angle (90°) Printed Board Mount Termination	25
Mounting Bracket	25

continued on next page. . .



S M P L S E R I E S

continued from previous page. . . .

Alignment Bar Dimensions	25
Right Angle (90°) Printed Board Hole Pattern	26
Ordering Information	27

U N I Q U E F E A T U R E S

Introduction	28
Low Profile Space Saving High Reliability Mezzanine Connector	28
Customer Specified Contact Termination Length	29
Flush Panel Connector Mounting Brackets	29
Polarization & Coding (Keying) Options	30

A C C E S S O R I E S

Panel Cut-Out Dimensions.....	30
Polarizing Guides	31
Fixed and Rotating Jackscrew Systems	31
Polarizing Guide and Jackscrew Thread Availability Chart	31
Polarizing Guide	32
Jackscrew System	33
Connector Housing (Shells)	34
Aluminum Backshell.....	35
Aluminum Backshell with Jackscrew System	35
Full Access Aluminum Backshell with Jackscrew System	36
Quick Disconnect Locking Device	36

A P P L I C A T I O N T O O L S

Introduction	37
Contact Application Tools Cross Reference List	38
Compliant Press-In Connector Installation Tools	39

P C B P R I N T E D H O L E S I Z E

Suggested Printed Board Hole Sizes for Compliant Press-In Connectors	40
--	----

S P E C I A L O P T I O N S

Modifications (MOS)	41
---------------------------	----

M I L Q U A L I F I E D P R O D U C T S

Positronic offers a wide variety of QPL connector products	42
--	----



What Makes Positronic's "PosiBand®" Contact Interface a Significant Improvement?

High reliability connectors utilize female **closed entry contacts** that provide an unbroken ring of solid material at the face of the contact. The closed entry feature is **crucial in preventing damage** to female contacts used in harsh environments, repeated mating cycles, blind mate applications and applications requiring highest reliability.

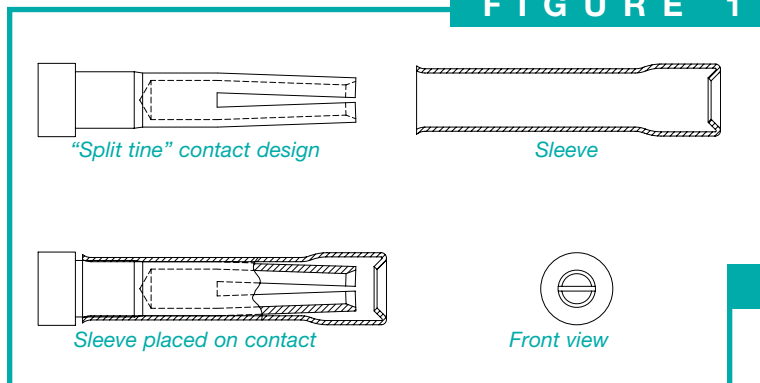
FIGURE 1

The most common **closed entry design** utilized by connector manufacturers is a split tine and sleeve concept. **See figure 1.** With this design, both the mechanical forces and

electrical interface are provided only at the tip of the female contact.

Positronic's **PosiBand technology** takes a unique approach for closed entry female contacts.

PosiBand contacts utilize a two-piece contact design. **See figure 2.** Each piece serves a separate function, providing a more mechanically robust contact and more consistent electrical performance.

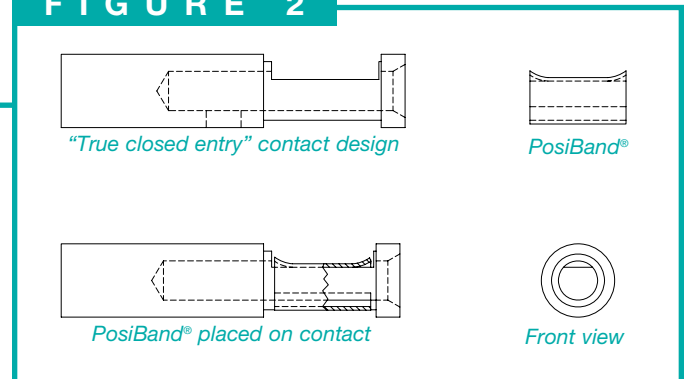
FIGURE 2

The main body of the **PosiBand** contact provides a true closed entry opening to enhance robustness. The **PosiBand** spring clip provides normal force on the male contact. Consistent electrical performance is supported through a larger area of contact interface between the male and female contact along the entire "floor" of the contact body. **PosiBand** contacts are QPL listed under **SAE AS39029** and **MIL-DLT-24308** specifications. **PosiBand** is also qualified under **GSFC S-311-P4/08 Rev C** and **GSFC S-311-P4/10 Rev C** to the higher 40 gram contact separation test requirement.

continued on next page . . .



continued from previous page . . .

The PosiBand® contact system has many advantages over the legacy split tine design.

- X PosiBand** is more robust than split tine contact, which can be pried open in harsh environments, resulting in reduced normal force and degradation of electrical performance.
- X PosiBand** has greater surface area at the male and female contact interface, resulting in more consistent electrical performance.
- X PosiBand** has lower average insertion forces, resulting in greater ease in mating, especially in larger high density connectors. The average lower insertion force is accomplished while meeting or exceeding performance requirements.
- X** The **PosiBand's** contact body does not require annealing of the crimp barrels, as does the split tine design. This eliminates concern of unintentionally heat-treating the mating end of the contact, which can cause electrical failure.
- X PosiBand** is qualified under **SAE AS39029** and **MIL-DTL-24308** specifications. **PosiBand** is also qualified under **GSFC S-311-P4/08 Rev C** and **GSFC S-311-P4/10 Rev C** to the higher 40 gram contact separation test requirement.
- X PosiBand** is protected by US Patent 7,115,002.

For more details about the *advantages of the PosiBand®* system, please view the detailed white paper at www.connectpositronic.com/posiband/ or visit our website at www.connectpositronic.com.

TEMPERATURE RISE CURVES

Test conducted in accordance with UL1977.

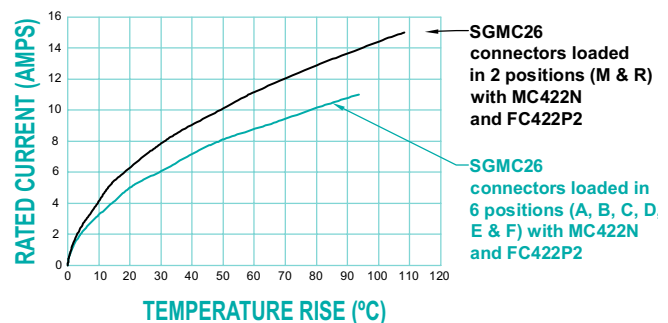
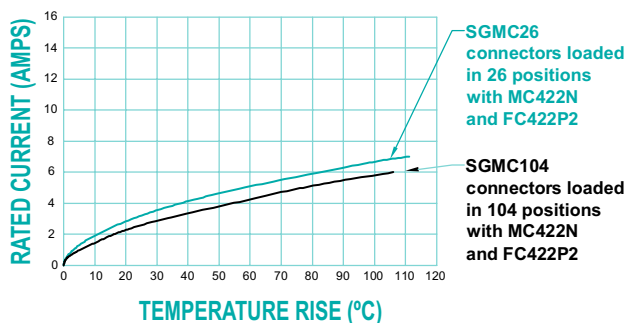

Size 22 PosiBand Contacts

Initial Contact Resistance: 0.004 ohms, maximum.
Curve developed with contacts terminated to size 22 AWG wire.

DIMENSIONS ARE IN INCHES [MILLIMETERS].
ALL DIMENSIONS ARE SUBJECT TO CHANGE.



CONNECTOR COMPONENT DESCRIPTION AND TERMINOLOGY

See “*Supplemental Definitions*” for clarification of “*italicized*” terms.

FOR ILLUSTRATIONS, SEE PAGE 3.

- A1** – Connector contact: The primary electrically conductive element of connectors. The contact system is comprised of a *male contact* and a *female contact*. In general, contacts are available in a wide variety of sizes. The contacts in this catalog are size 22 (0.030 inches [0.76mm] in diameter). Contacts can be provided with multiple *termination types*, including wire *crimp* and solder; printed circuit board (pcb) solder, straight and right angle mount; and straight mount *compliant press-in*. A male crimp termination contact is shown in the example.
- A2** – See definitions outlined in A1. A female crimp termination contact is shown in the example.
- A3** – See definitions outlined in A1. A female right angle pcb solder termination is shown in the example.
- A4** – See definitions outlined in A1. A female straight pcb solder termination is shown in the example.
- B1** – Connector insert: The connector insulating element which also supports and positions the contacts in the connector system. Connectors can be supplied as a *free connector* or a *fixed connector*. Connector systems are available with a wide variety of *contact variants* and *termination types*. A 26 contact variant free connector for use with size 22 male crimp contacts is shown in the example.
- B2** – See definitions outlined for B1. A 26 contact variant fixed connector with size 22 female contacts and right angle solder terminations is shown in the example.
- B3** – A 26 contact variant free connector for use with size 22 male crimp contacts is shown in the example.
- B4** – See definitions outlined for B1. A 26 contact variant fixed connector with size 22 female contacts and straight solder terminations is shown in the example.
- B5** – See definitions outlined for B1. A 104 contact variant fixed bulkhead or panel mount connector for use with size 22 female crimp contacts is shown in the example.
- B6** – A 104 contact variant free connector for use with size 22 male crimp contacts is shown in the example.
- C1** – Male and female guides – Used to guide the mating of connector pairs and ensure proper alignment of contacts. A *polarized* guide system is shown in the example. Guide systems can also be used as a *coding device* for 75 and 104 variant connectors when used in corner position mounting holes.
- C2** – Jackscrew system – A *locking device* which uses the mechanical advantage of male and female screw threads to couple and uncouple connector pairs. The system consists of a fixed jackscrew and a rotating jackscrew. A *polarized* jackscrew system is shown in the example. Jackscrew systems can also be used as a *coding device* for connectors.
- C3** – Quick disconnect locking device – Device which allows for rapid connect and disconnect of connector pairs. The system shown in the example consists of fixed lock tabs and actuation levers.

- C4** – Backshell – Connector accessory (commonly referred to as a “hood” or “cable adapter”) which is used on *free connectors* to support cable or wires and to protect contact terminations. Backshell may be used with other accessories such as jackscrew and quick disconnect locking systems, guides, and connector housings as shown in the examples.
- C5** – Connector Housing – Connector accessory (commonly referred to as a “shell” or “shroud”) which protects the mating portion of the connector contacts. Connector housings are capable of serving as a *coding device* with the use of pin and slot system shown in this catalog, *see page 34 for details*.
- C6** – Mounting bracket – Connector accessory used to mechanically fix a connector to a mounting surface. The example shows a mounting bracket used to secure a right angle solder connector to a pcb.

SUPPLEMENTAL DEFINITIONS

- Male contact** - Contact gender in which mechanical and electrical engagement is made on the outer surface of the contact.
- Female contact** – Contact gender in which mechanical and electrical engagement is made on the inner surface of the contact.
- Size (contact)** – A designation to differentiate one contact from another. Numbers are commonly used for this purpose. The designator numbers are associated with a specific male contact diameter; the smaller the designator, the larger the contact size.
- Termination type** - Means of making connection between the contact and external conductors.
- Compliant press-in termination** – A termination with a specially shaped section designed to provide an electrically secure solderless connection when pressed into a printed circuit board (pcb).
- Crimp contact termination** – A contact having a barrel which accepts a conductor and the barrel is designed to be crimped.
- Free connector** – The portion of connector system designed for attachment to the free end of wire or cable.
- Fixed connector** – The portion of connector system designed for attachment to a rigid surface.
- Contact variant** – The number, size, and arrangement of contacts.
- Polarization (connector mating)** - Integral feature within a connector system to ensure corresponding male and female contacts are engaged when the connectors are mated.
- Coding device** – Means of preventing the mating of a connector to any connector other than its intended mate. Also referred to as “keying”.
- Locking device (connector)** – An accessory that provides mechanical retention of mated connectors.

Connector component terminology is based on I.E.C. (International Electrotechnical Commission) language. See <http://www.electropedia.org/> for more information.



Positronic
connectpositronic.com

SGMC SERIES INDUSTRIAL / MILITARY QUALITY REMOVABLE CONTACTS

High
Density
Rectangular



- ✓ High reliability connectors with **removable** contacts.
- ✓ Contacts are high density size 22.
- ✓ Terminations: crimp, solder cup, straight solder and compliant press-in printed board mount. See pages 11- 14 for details.
- ✓ Female closed entry contacts utilize the "PosiBand®" system. See page 1 for details.
- ✓ Current ratings: signal level to 13 amperes. See temperature rise curves on page 2 for details.
- ✓ Eleven connector variants, 4 - 104 contacts.
- ✓ A multitude of polarization and connector coding (keying) options. See pages 30-34 for details.
- ✓ Intermateable with SGM and SMPL series. See page 15 for SGM series and page 23 for SMPL series.
- ✓ Thermocouple contact options available.
- ✓ A wide variety of options and accessories.

Connectors Qualified to:

- DSCC Drawing No. 86040 & 86078
- MIL-C-28748/13 & 28748/14

Contacts Qualified to:

- SAE AS39029/34 & 39029/35

Telecommunication:

- UL File # E49351

TECHNICAL CHARACTERISTICS

MATERIALS AND FINISHES:

Connector Insert:	Glass filled DAP per ASTM-D-5948 type SDG-F. Green color is standard, black or grey available.
Removable Contacts:	Precision machined copper alloy. 0.000015 inch [0.38 µ] gold over nickel. Other finishes available upon request, see pages 11-14 for details.
Polarizing Guides:	Copper alloy with nickel plate or passivated stainless steel.
Jackscrew System:	Passivated stainless steel.
Connector Housing (Shells):	Aluminum with yellow anodize or black anodize1.

Backshell:

Aluminum with yellow or black anodize.

Quick Disconnect Locking Device:

Actuation lock lever and lock tab, copper alloy with nickel plate.

MECHANICAL CHARACTERISTICS:

Removable Contacts:

Insert contact to rear face of connector insert, release from front face of connector insert. Size 22 contact, male contact - 0.030 inch [0.76mm] mating diameter. Female contact - PosiBand closed entry design, see page 1 for details.

Contact Retention in Connector Insert:

6 lbs. [26.5N] minimum.

continued on next page. . . .

TECHNICAL CHARACTERISTICS, continued

continued from previous page. . . .

MECHANICAL CHARACTERISTICS, continued:

- Contact Termination:** Crimp all wire sizes from 20 AWG [0.5 mm²] through 28 AWG [0.08 mm²].
Solder cup - 0.035 inch [0.89mm] hole diameter for 22 AWG [0.3mm²] wire maximum. 0.045 inch [1.14mm] hole diameter for 20 AWG [0.5mm²] wire maximum.
Straight printed board mount - 0.025 inch [0.64mm] termination diameter.
Compliant press-in termination.
- Locking Systems:** Friction, quick disconnect locking device and jackscrews.
- Polarization:** Polarized guides and jackscrew system.
- Coding (Keying) Device:** Pin and slot system; male and female guide system.
- Mechanical Operations:** 1000 operations
- Jackscrews:** Standard threads, 2-56 UNC on all sizes, except 75 and 104 connector variants, which use 6-32 UNC. Metric threads, M2X0.4 and M3X0.5 available.

ELECTRICAL CHARACTERISTICS:

- Contact Current Rating, Tested per UL 1977:**
13 amperes, 2 contacts energized.
10 amperes, 6 contacts energized.
6 amperes, 26 contacts energized.
5 amperes, 104 contacts energized
See temperature rise curves on page 2 for details.
- Initial Contact Resistance:** 0.004 ohms, maximum.
- Flash over Voltage:** 2200 V.AC (rms)
- Test Voltage:** 1000 V.AC (rms)
- Insulation Resistance:** 5 G ohms, minimum.
- Clearance and Creepage Distance:** 0.060 inch [1.52 mm], minimum.
- Working Temperature:** -55°C to 135°C
- Working Voltage:** 250 V.AC (rms)

THERMOCOUPLE CONTACTS:

- Size 22 removable crimp contacts are available, *see page 12 for details.*
Straight printed circuit board mount contacts are available in SGM series, *see page 16 for details.*
Right angle (90°) printed circuit board mount contacts are available in SMPL series, *see page 24 for details.*

Visit our web site for the latest catalog updates and supplements at
<https://www.connectpositronic.com/catalogs/>

Do you need 2-D drawings or 3-D models?

Once you have made a connector selection, contact Technical Sales if you would like a 2-D drawing or 3-D model. If we do not have your specific part number on file, we can create one for you. Or, please visit www.connectpositronic.com and use the search function.

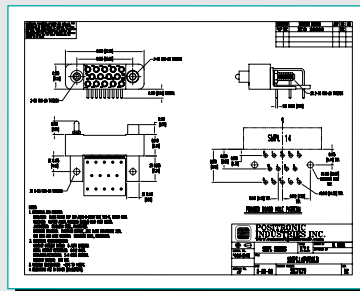

2-D Drawing

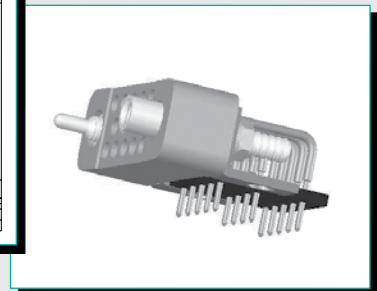

3-D Model



Positronic
connectpositronic.com

SGMC SERIES INDUSTRIAL / MILITARY QUALITY REMOVABLE CONTACTS

High
Density
Rectangular

CONNECTOR INSERT DIMENSIONS MATING FACE VIEW OF FEMALE OR REAR FACE VIEW OF MALE

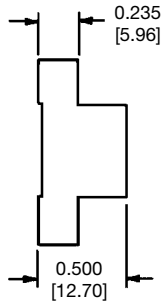

MALE AND FEMALE
PROFILE VIEW

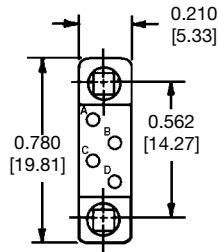

SGMC 4

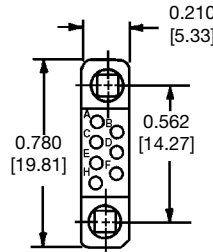

SGMC 7

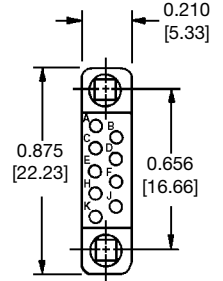

SGMC 9

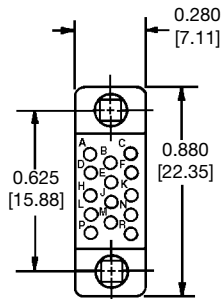

SGMC 14

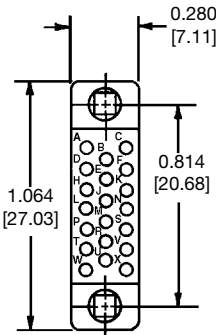

SGMC 20

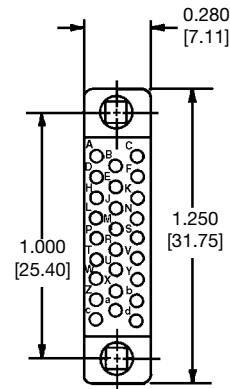

SGMC 26

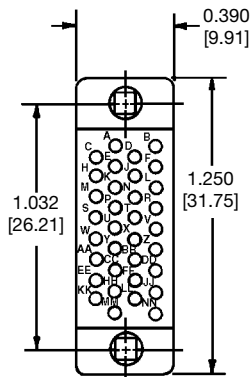

SGMC 34

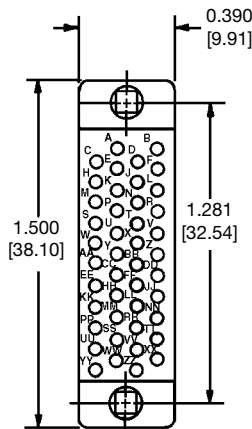

SGMC 44

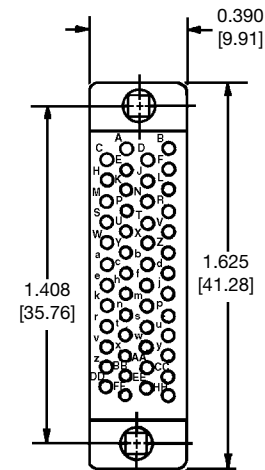

SGMC 50

CONTACT HOLE PATTERNS:

For SGMC series contact hole patterns, refer to page 21 in SGM series.

For information regarding **REMOVABLE CONTACTS**, see contact illustration drawings and charts on pages 11-14.



CONNECTOR INSERT DIMENSIONS
MATING FACE VIEW OF FEMALE OR REAR FACE VIEW OF MALE

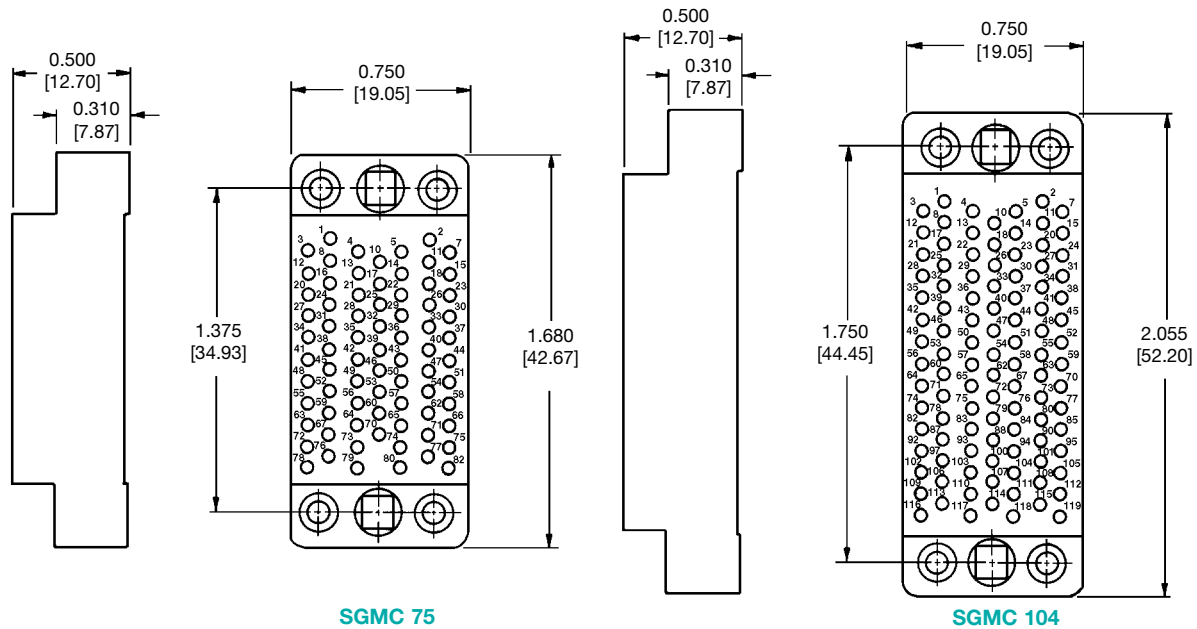

SGMC SERIES

**CONTACT HOLE POSITION DIMENSIONS AND
PRINTED BOARD HOLE PATTERN FOR CONTACT VARIANTS 75 AND 104**
MATING FACE VIEW OF FEMALE OR REAR FACE VIEW OF MALE

For contact hole patterns for SGM series sizes 4 - 50, refer to page 21 in SGM series.

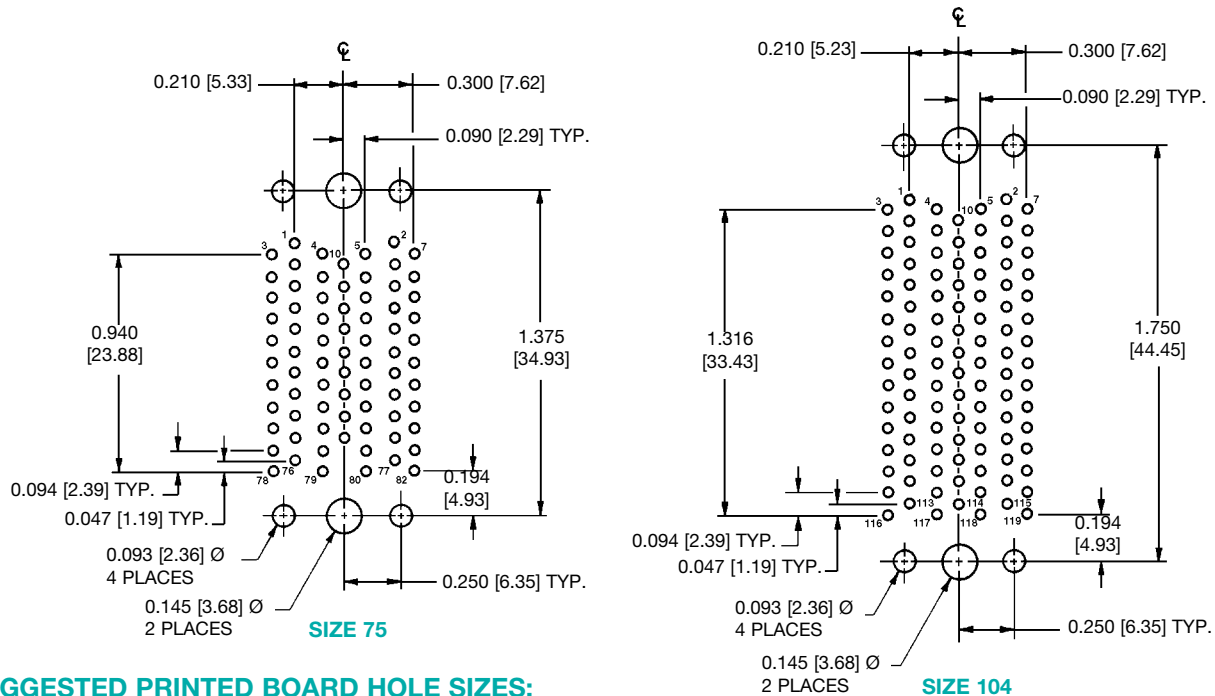

SUGGESTED PRINTED BOARD HOLE SIZES:

Suggest 0.040 [1.01] Ø holes in printed board for contact terminations.

For information regarding **REMOVABLE CONTACTS**, see contact illustration drawings and charts on pages 11-14.



REMOVABLE CONTACT ORDERING ASSISTANCE CHART

SGMC SERIES CRIMP AND SOLDER CUP CONTACT TERMINATIONS

TERMINATION TYPE	PAGE NUMBER REFERENCE IN CATALOG	CONTACT SIZE	FEMALE PART NUMBER	MALE PART NUMBER	WIRE SIZE AWG [mm ²]
CRIMP	see page 11 for additional information	22	FC422P2	MC422N	$\frac{22}{0.3} / \frac{24}{0.25} / \frac{26}{0.12} / \frac{28}{0.08}$
			FC420P2	MC420N	20 [0.5]
MILITARY CRIMP	see page 12 for additional information	22	M39029/35-441	M39029/34-440	$\frac{22}{0.3} / \frac{24}{0.25} / \frac{26}{0.12} / \frac{28}{0.08}$
THERMOCOUPLE CRIMP	see page 12 for additional information	22	FC422P2CH	MC422NCH	$\frac{22}{0.3} / \frac{24}{0.25} / \frac{26}{0.12}$
			FC422P2AL	MC422NAL	
			FC422P2CU	MC422NCU	
			FC422P2CO	MC422NCO	
SOLDER CUP	see page 13 for additional information	22	FS422P2	MS422N	22 [0.3] max.
			FS420P2	MS420N	20 [0.5] max.

NOTE: For ordering crimp contacts on reels, add "R" to part number, see page 11 for details. Examples: MC422NR or FC422P2R

SGMC SERIES PRINTED BOARD MOUNT CONTACT TERMINATIONS

TERMINATION TYPE	PAGE NUMBER REFERENCE IN CATALOG	CONTACT SIZE	FEMALE PART NUMBER	MALE PART NUMBER	USABLE TERMINATION LENGTH	TERMINATION DIMENSION
STRAIGHT SOLDER	see page 13 for additional information	22	FDS425P2	MDS425N	0.125 [3.18]	$\frac{0.025}{0.64} \varnothing$
			FDS456P2	MDS456N	0.156 [3.96]	$\frac{0.025}{0.64} \varnothing$
			FDS487P2	MDS487N	0.187 [4.75]	$\frac{0.025}{0.64} \varnothing$
COMPLIANT PRESS-IN	see page 14 for additional information	22	FPF467P2	MPF467N	N/A	$\frac{0.048}{1.22} \varnothing$

NOTE: Positronic recommends printed circuit board contacts be supplied installed in the connector. Contact technical sales.

For information regarding **REMOVABLE CONTACTS**, see contact illustration drawings and charts on pages 11-14.

For information regarding **CRIMP TOOLS & CRIMPING TOOL TECHNIQUES**, see page 37.

High
Density
Rectangular

SGMC SERIES
INDUSTRIAL / MILITARY QUALITY
REMOVABLE CONTACTS



Positronic
connectpositronic.com

ORDERING INFORMATION - CODE NUMBERING SYSTEM

Specify Complete Connector By Selecting An Option From Step 1 Through 9

STEP	1	2	3	4	5	6	7	8	9	10
EXAMPLE	SGMC	14	S	0	ESS	0	0	0	0	-14

STEP 1 - BASIC SERIES

SGMC series

STEP 2 - CONNECTOR VARIANTS

4, 7, 9, 14, 20, 26, 34, 44, 50, 75, 104

STEP 3 - CONNECTOR GENDER

M - Male
S - Female - PosiBand closed entry contacts, see page 1 for more information.

STEP 4 - CONTACT TERMINATION TYPE

0 - Contacts are to be ordered separately, see contact ordering chart on page 9.

***1 STEP 5 - POLARIZING GUIDES AND JACKSCREW SYSTEMS**

N - Polarizing guides.
NSS - Stainless steel polarizing guides.
T - Fixed jackscrews.
E - Rotating jackscrews with knobs.
E1 - Rotating jackscrews used with backshell only. Not offered on 75 and 104 variants.
ESS - Short rotating jackscrews.
0 - If no polarizing guides or jackscrews are required. Also use "0" if ordering backshell equipped with jackscrews, for variants 75 and 104, see STEP 8.

NOTE:

*1 For details of items listed in steps 5 through 9, see Accessories section on pages 30-36.

*2 Select '0' in Step 6 when selecting 'V' and 'VL' options.

STEP 10 - SPECIAL OPTIONS

FOR SPECIAL OPTIONS, SEE SPECIAL OPTIONS APPENDIX ON PAGE 41.

***1 STEP 9 - ADDITIONAL FEATURES**

B - For black anodized aluminum parts.
R - For yellow chromate coating on aluminum parts.
*2 V - Lock tab, not offered on 75 and 104 variants.
*2 VL - Actuation lock lever, not offered on 75 and 104 variants.
0 - If no additional options are required.
M - Jackscrews with metric threads.

***1 STEP 8 - BACKSHELL**

V - Side opening backshell equipped with stainless steel jackscrew system offered on 104 variant only.
Z - Top opening backshell equipped with stainless steel jackscrew system offered on 104 variants only.
J - Top opening backshell offered on all variants except 75 and 104.
0 - If no backshell are required.

***1 STEP 7 - CODING (KEYING) POSITIONS OF CONNECTOR HOUSING (SHELLS)**

Select letter to designate position of male pin or female slot for coding system.

A, B, C, D, E, F, G
0 - If no coding is required or if no connector housings are required.

***1 STEP 6 - CONNECTOR HOUSING (SHELLS)**

P - Male shell.
R - Female shell.
0 - If no connector housings are required.

SGMC SERIES

Do you need 2-D drawings or 3-D models?

See page 6 for more information!

For information regarding **CRIMP TOOLS & CRIMPING TOOL TECHNIQUES**, see page 37.



REMOVABLE CONTACT TECHNICAL CHARACTERISTICS

SIZE 22 REMOVABLE CONTACT

MATERIALS AND FINISHES:

Precision machined copper alloy. 0.000015 inch [0.38 μ] gold over nickel. Other finishes available upon request, for details, see optional plating finishes below.

MECHANICAL CHARACTERISTICS:

Insert contact to rear face of connector insert, release from front face of connector insert. Size 22 contact, male - 0.030 inch [0.76mm] mating diameter. Female contact - PosiBand closed entry design, see page 1 for details. Terminations for 20, 22, 24, 26, and 28 AWG.

ELECTRICAL CHARACTERISTICS:

Contact Current Rating, Tested per UL 1977:

- 13 amperes, 2 contacts energized.
- 10 amperes, 6 contacts energized.
- 6 amperes, 26 contacts energized.
- 5 amperes, 104 contacts energized

See temperature rise curves on page 2 for details.

Initial Contact Resistance: 0.004 ohms, maximum.

OPTIONAL PLATING FINISHES

- 14 0.000030 [0.76 μ] gold over nickel by adding "-14" suffix onto part number. Example: FC422P2-14.
- 15 0.000050 inch [1.27μ] gold over nickel by adding "-15". Example: FC422P2-15.

REELED CONTACTS:

Contacts may be supplied in plastic carriers, packaged in reels holding 2,000 contacts for use with the automatic pneumatic crimp tools, catalog part number 9550-1. The same type carrier is used for both male and female contacts.

All male and female crimp contacts can be ordered in reels by adding letter "R" after the contact part number, such as MC420NR for a male contact and FC422P2R for female contact.



Enlarged section of plastic contact carriers

REMOVABLE CRIMP CONTACT

FOR USE WITH SGMC SERIES CONNECTORS

SIZE 22

Note: Connectors can be kitted with all applicable crimp/solder contacts, contact Technical Sales for connector part number.

CLOSED CRIMP BARREL WITH INSULATION SUPPORT

FEMALE CONTACT
"CLOSED ENTRY" DESIGN

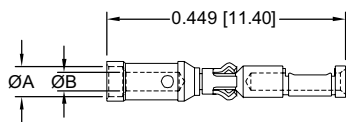

MALE CONTACT

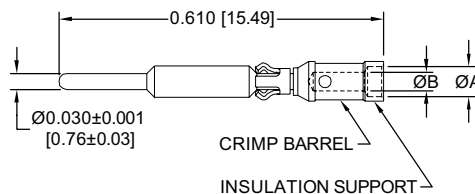

FEMALE PART NUMBER	WIRE SIZE AWG [mm ²]	ØA	ØB
FC422P2	22 / 24 / 26 / 28 [0.3/0.25/0.12/0.08]	0.056 [1.42]	0.035 [0.89]
FC420P2	20 [0.5]	N/A	0.045 [1.14]

MALE PART NUMBER	WIRE SIZE AWG [mm ²]	ØA	ØB
MC422N	22 / 24 / 26 / 28 [0.3/0.25/0.12/0.08]	0.056 [1.42]	0.035 [0.89]
MC420N	20 [0.5]	N/A	0.045 [1.14]

For information regarding CRIMP TOOLS & CRIMPING TOOL TECHNIQUES, see page 37.



REMOVABLE MILITARY CRIMP CONTACT
FOR USE WITH SGMC SERIES CONNECTORS

SIZE 22

QUALIFIED TO SAE AS39029

Note: Connectors can be kitted with all applicable crimp/solder contacts, contact Technical Sales for connector part number.

***MILITARY SPECIFICATION CONTACTS**

STANDARD FINISH:
per SAE AS39029 specifications

COLOR CODE:

MALE CONTACT:
YELLOW/YELLOW/BLACK

FEMALE CONTACT:
YELLOW/YELLOW/BROWN

FEMALE CONTACT
"CLOSED ENTRY" DESIGN

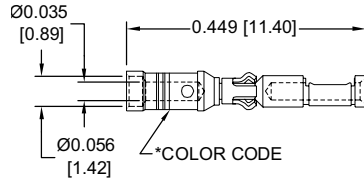

MALE CONTACT

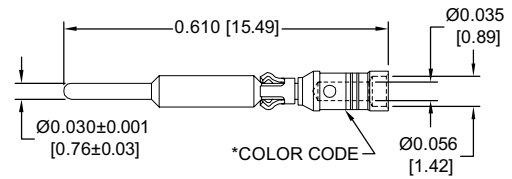

FEMALE PART NUMBER	WIRE SIZE AWG/[mm ²]
*M39029/35-441	22 / 24 / 26 / 28 [0.3/0.25/0.12/0.08]

MALE PART NUMBER	WIRE SIZE AWG/[mm ²]
*M39029/34-440	22 / 24 / 26 / 28 [0.3/0.25/0.12/0.08]

REMOVABLE THERMOCOUPLE CRIMP CONTACT
FOR USE WITH SGMC SERIES CONNECTORS

SIZE 22

Note: Connectors can be kitted with all applicable crimp/solder contacts, contact Technical Sales for connector part number.

FEMALE CONTACT
"CLOSED ENTRY" DESIGN

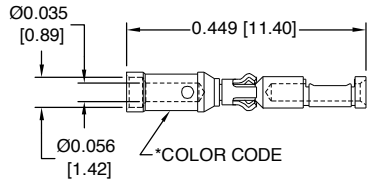

MALE CONTACT

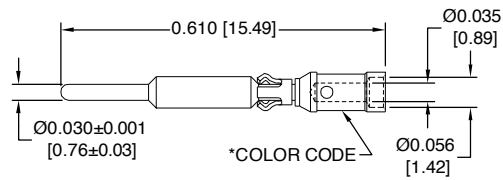

TYPE	MATERIAL	FEMALE PART NUMBER	MALE PART NUMBER	COLOR CODE*	WIRE SIZE AWG [mm ²]
K	CHROMEL (+) with gold flash	FC422P2CH	MC422NCH	WHITE	22 / 24 / 26 [0.3 / 0.25 / 0.12]
	ALUMEL (-)	FC422P2AL	MC422NAL	GREEN	22 / 24 / 26 [0.3 / 0.25 / 0.12]
T	COPPER (+)	FC422P2CU	MC422NCU	RED	22 / 24 / 26 [0.3 / 0.25 / 0.12]
	CONSTANTAN (-)	FC422P2CO	MC422NCO	YELLOW	22 / 24 / 26 [0.3 / 0.25 / 0.12]
E	CHROMEL (+)	FC422P2CH	MC422NCH	WHITE	22 / 24 / 26 [0.3 / 0.25 / 0.12]
	CONSTANTAN (-)	FC422P2CO	MC422NCO	YELLOW	22 / 24 / 26 [0.3 / 0.25 / 0.12]

For more information on the availability of Type J thermocouple contacts, please contact Technical Sales.

For more information about thermocouple contacts with printed circuit board solder termination, please contact Technical Sales.

Chromel® and Alumel® are registered trademarks of Hoskins Manufacturing Company

For information regarding **CRIMP TOOLS & CRIMPING TOOL TECHNIQUES**, see page 37.



Positronic
connectpositronic.com

SGMC SERIES INDUSTRIAL / MILITARY QUALITY REMOVABLE CONTACTS

High
Density
Rectangular

REMOVABLE SOLDER CUP CONTACT FOR USE WITH SGMC SERIES CONNECTORS SIZE 22

Note: Connectors can be kitted with all applicable crimp/solder contacts, contact Technical Sales for connector part number.

FEMALE CONTACT "CLOSED ENTRY" DESIGN

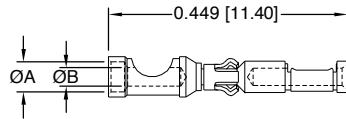

MALE CONTACT

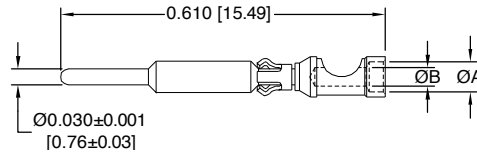

FEMALE PART NUMBER	WIRE SIZE AWG/[mm ²]	ØA	ØB
FS422P2	.22 [3/0]	0.056 [1.42]	0.035 [0.89]
FS420P2	.20 [0.5]	N/A	0.045 [1.14]

MALE PART NUMBER	WIRE SIZE AWG/[mm ²]	ØA	ØB
MS422N	.22 [3/0]	0.056 [1.42]	0.035 [0.89]
MS420N	.20 [0.5]	N/A	0.045 [1.14]

REMOVABLE STRAIGHT SOLDER PRINTED BOARD MOUNT CONTACT*1 FOR USE WITH SGMC SERIES CONNECTORS*2 SIZE 22

Note: Connectors can be kitted with all applicable crimp/solder contacts, contact Technical Sales for connector part number.

FEMALE CONTACT "CLOSED ENTRY" DESIGN

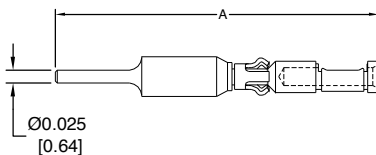

MALE CONTACT

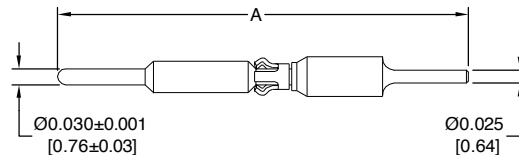

FEMALE PART NUMBER	A	B See below illustration
FDS425P2	0.607 [15.42]	0.125 [3.18]
FDS456P2	0.638 [16.21]	0.156 [3.96]
FDS487P2	0.669 [16.99]	0.187 [4.75]

MALE PART NUMBER	A	B See below illustration
MDS425N	0.772 [19.61]	0.125 [3.18]
MDS456N	0.803 [20.40]	0.156 [3.96]
MDS487N	0.834 [21.18]	0.187 [4.75]

CONTACT HOLE PATTERNS:

For SGMC series contact hole patterns, refer to page 21 in SGM series.

NOTES: *1 Positronic recommends printed circuit board contacts be supplied installed in the connector. Contact technical sales.

*2 Positronic recommends the practice of using mounting hardware to secure connector to printed circuit board, see mounting hardware presentation on page 14.

For information regarding **CRIMP TOOLS & CRIMPING TOOL TECHNIQUES**, see page 37.



REMOVABLE COMPLIANT PRESS-IN PRINTED BOARD MOUNT CONTACT*1
FOR USE WITH SGMC SERIES CONNECTORS*2
SIZE 22

FEMALE CONTACT
"CLOSED ENTRY" DESIGN

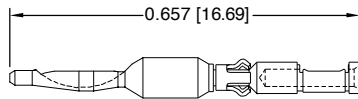

PART NUMBER: FPF467P2

MALE CONTACT

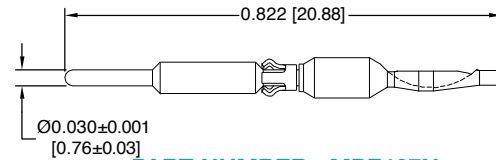

PART NUMBER: MPF467N

SUGGESTED PRINTED BOARD HOLE SIZES:

Suggest 0.105 [2.66] Ø hole in printed board for connector mounting holes.

NOTE: For suggested printed board recommended drill hole sizes, plating and finished hole sizes for compliant contact termination positions, see page 40.

For compliant press-in connector installation tools, see page 39.

CONTACT HOLE PATTERNS:

For SGMC series contact hole patterns, refer to page 21 in SGM series.

Note: Unless otherwise specified, compliant press-in contacts are not supplied with SGMC connectors and must be ordered separately. Contacts may be installed in connector to custom order.

NOTES: *1 Positronic recommends printed circuit board contacts be supplied installed in the connector. Contact technical sales.

*2 Positronic recommends the practice of using mounting hardware to secure connector to printed circuit board, see mounting hardware presentation below.

MOUNTING HARDWARE FOR PRINTED BOARD MOUNT CONNECTORS

FOR USE WITH SGMC OR SGM SERIES CONNECTORS

SGMC CONNECTOR INSERT SHOWN IN ILLUSTRATION FOR REFERENCE

Positronic recommends the practice of using mounting hardware. Stresses that occur during coupling and uncoupling of connectors or through shock and vibration of systems can be transferred to printed circuit boards through compliant press-in connector terminations. Avoid concern over electrical integrity of the connector to board interface by using mounting screws.

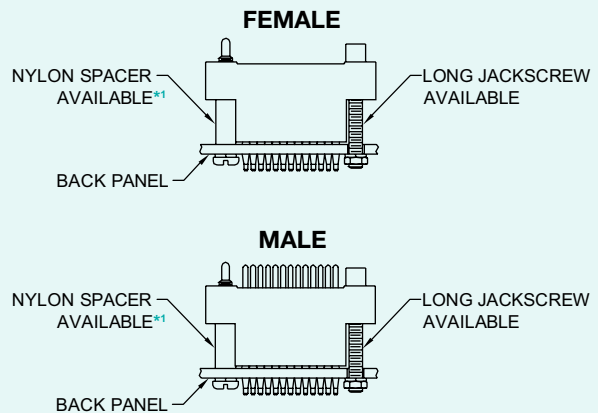

NOTE: *1 Stainless steel spacer available.

CONTACT TECHNICAL SALES FOR PART NUMBERS WITH LONG JACKSCREW OR NYLON SPACER*1 !

For information regarding **CRIMP TOOLS & CRIMPING TOOL TECHNIQUES**, see page 37.



Positronic
connectpositronic.com

SGM SERIES

INDUSTRIAL / MILITARY QUALITY

FIXED STRAIGHT PCB MOUNT / SOLDER CUP

High
Density
Rectangular

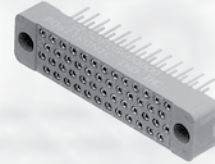
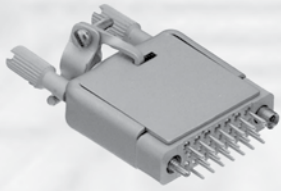

High reliability connectors with **fixed** contacts.



Contacts are high density size 22.



Terminations: wire wrap, solder cup, straight solder and compliant press-in printed board mount. See pages 18-20 for details.



Female closed entry contacts utilize the "PosiBand[®]" system. See page 1 for details.



Current ratings: signal level to 13 amperes. See temperature rise curves on page 2 for details.



Twelve connector variants, 4 - 50 contacts.



A multitude of polarization and connector coding (keying) options. See pages 30-34 for details.



Intermateable with SGMC and SMPL series. See page 5 for SGMC series and page 23 for SMPL series.



Thermocouple contact options available.



A wide variety of options and accessories.



Qualified to:

- MIL-DTL-28748/7 & 28748/8

Telecommunication:

- UL File # E49351

TECHNICAL CHARACTERISTICS

MATERIALS AND FINISHES:

Connector Insert:	Glass filled DAP per ASTM-D-5948 type SDG-F. Grey color is standard, black or green available.
Fixed Contacts:	Precision machined copper alloy. 0.000015 inch [0.38 μ] gold over nickel. Other finishes available upon request, see page 41 for details.
Polarizing Guides:	Copper alloy with nickel plate or passivated stainless steel.
Jackscrew System:	Passivated stainless steel.
Connector Housing (Shells):	Aluminum with yellow anodize or black anodize.
Backshell:	Aluminum with yellow or black anodize.

Quick Disconnect Locking Device:

Actuation lock lever and lock tab, copper alloy with nickel plate.

MECHANICAL CHARACTERISTICS:

Fixed Contacts:

Size 22, male contact 0.030 inch [0.76 mm] mating diameter. Female contact - PosiBand closed entry design, see page 1 for details.

Contact Retention in Connector Insert:

6 lbs. [26.5N] minimum.

Contact Termination:

Solder cup contacts - 0.037 inch [0.94 mm] internal hole diameter for 22 AWG [0.3 mm²] wire maximum.
Straight printed board mount - 0.025 inch [0.64 mm] termination diameter.

High
Density
Rectangular

SGM SERIES

INDUSTRIAL / MILITARY QUALITY
FIXED STRAIGHT PCB MOUNT / SOLDER CUP



Positronic
connectpositronic.com

TECHNICAL CHARACTERISTICS, continued

continued from previous page. . . .

MECHANICAL CHARACTERISTICS, continued:

	Wire post - 0.025 inch [0.64 mm] square.
	Compliant press-in termination.
Locking Systems:	Friction, quick disconnect locking device and jackscrews.
Polarization:	Polarized guides and jackscrew system.
Coding (Keying) Device:	Pin and slot system; male and female guide system.
Mechanical Operations:	1000 operations per IEC 60512-5.
Jackscrews:	Standard threads, 2-56 UNC on all sizes, Metric threads, M2X0.4 and M3X0.5 available.

Initial Contact Resistance:	0.004 ohms, maximum.
Flash over Voltage:	2200 V.AC (rms)
Test Voltage:	1000 V.AC (rms)
Insulation Resistance:	5 G ohms, minimum.
Clearance and Creepage Distance:	0.028 inch [0.71 mm], minimum.
Working Temperature:	-55°C to 135°C
Working Voltage:	250 V.AC (rms)

ELECTRICAL CHARACTERISTICS:

Contact Current Rating, Tested per UL 1977:

- 13 amperes, 2 contacts energized.
- 10 amperes, 6 contacts energized.
- 6 amperes, 26 contacts energized.
- 5 amperes, 104 contacts energized

See temperature rise curves on page 2 for details.

THERMOCOUPLE CONTACTS:

Straight printed circuit board mount contacts are available, please contact Technical Sales for details.

Right angle (90°) printed circuit board mount contacts are available in SMPL series, see page 24 for details.

Size 22 removable crimp contacts are available in SGMC series, see page 12 for details.

Visit our web site for the latest catalog updates and supplements at
<https://www.connectpositronic.com/catalogs/>

Do you need 2-D drawings or 3-D models?

Once you have made a connector selection, contact Technical Sales if you would like a 2-D drawing or 3-D model. If we do not have your specific part number on file, we can create one for you. Or, please visit www.connectpositronic.com and use the search function.

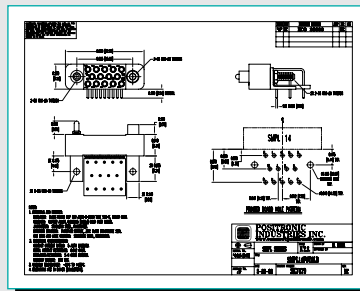

2-D Drawing

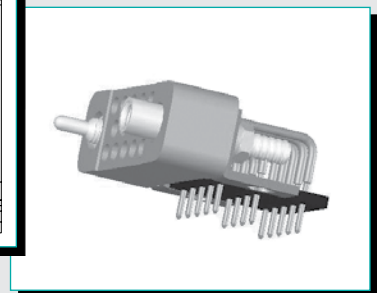

3-D Model



Positronic
connectpositronic.com

SGM SERIES

INDUSTRIAL / MILITARY QUALITY

FIXED STRAIGHT PCB MOUNT / SOLDER CUP

High
Density
Rectangular

CONNECTOR INSERT DIMENSIONS FOR SGM AND SMPL SERIES

MATING FACE VIEW OF FEMALE OR REAR FACE VIEW OF MALE

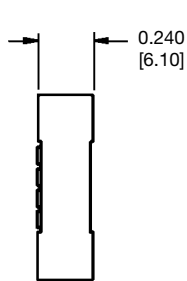

MALE AND FEMALE
PROFILE VIEW

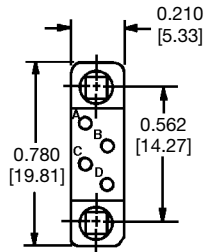

SGM 4
SMPL 4

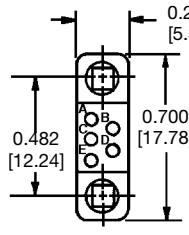

SGM 5
SMPL 5

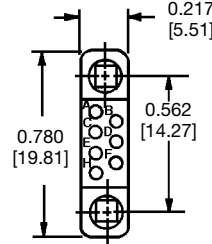

SGM 7
SMPL 7

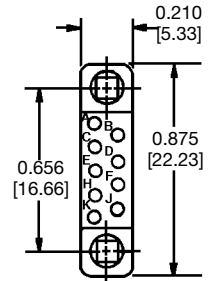

SGM 9
SMPL 9

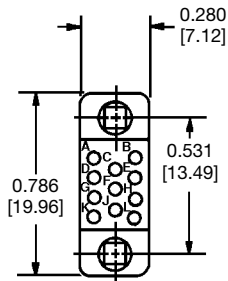

SGM 11
SMPL 11

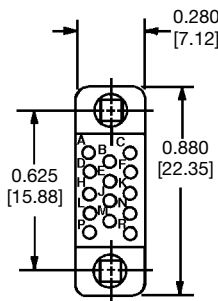

SGM 14
SMPL 14

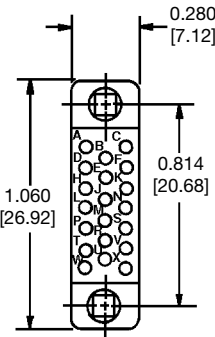

SGM 20
SMPL 20

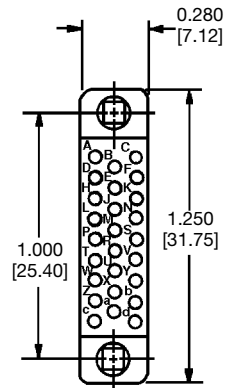

SGM 26
SMPL 26

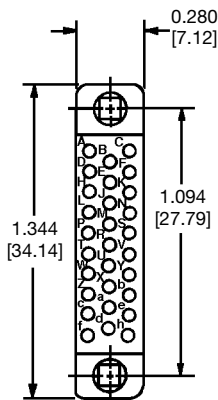

SGM 29
SMPL 29

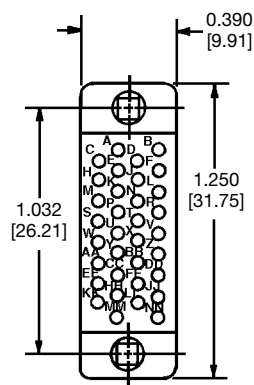

SGM 34
SMPL 34

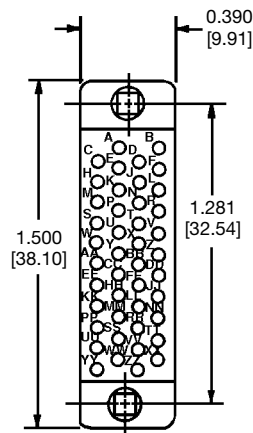

SGM 44
SMPL 44

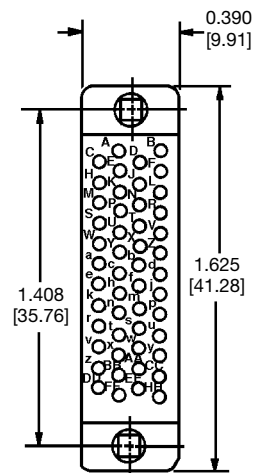

SGM 50
SMPL 50

CONTACT HOLE PATTERNS:

For SGM series contact hole patterns, refer to page 21 in SGM series.
For SMPL series contact hole patterns, refer to page 26 in SMPL series.

High
Density
Rectangular

SGM SERIES
INDUSTRIAL / MILITARY QUALITY
FIXED STRAIGHT PCB MOUNT / SOLDER CUP



Positronic
connectpositronic.com

STRAIGHT SOLDER PRINTED BOARD MOUNT TERMINATION
CODE DS3, DS4, DS5 AND DS6

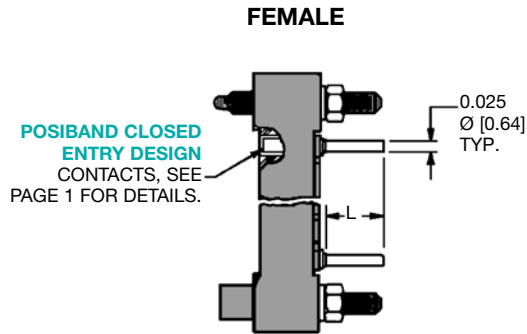

Typical Part Number:
SGM26SDS3T0000

CONTACT CODE	L
DS3	0.093 [2.36]
DS4	0.125 [3.18]
DS5	0.156 [3.96]
DS6	0.187 [4.75]

For straight solder contacts,
specify contact code in Step 4 of
ordering information.



Positronic
connectpositronic.com

SGM SERIES

INDUSTRIAL / MILITARY QUALITY

FIXED STRAIGHT PCB MOUNT / SOLDER CUP

High
Density
Rectangular

SOLDER CUP TERMINATION CODE SC

For solder cup contacts, specify contact code "SC" in Step 4 of ordering information.

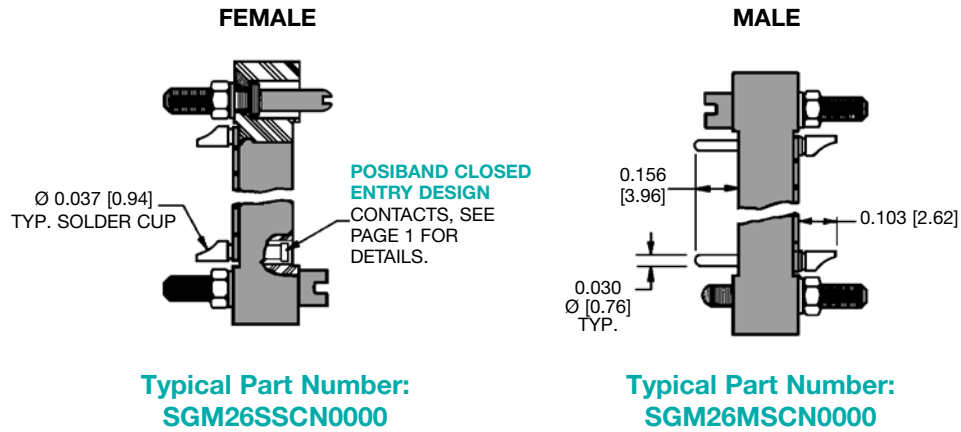

SGM SERIES



WRAP POST TERMINATION
CODE WW1 OR CODE WW2

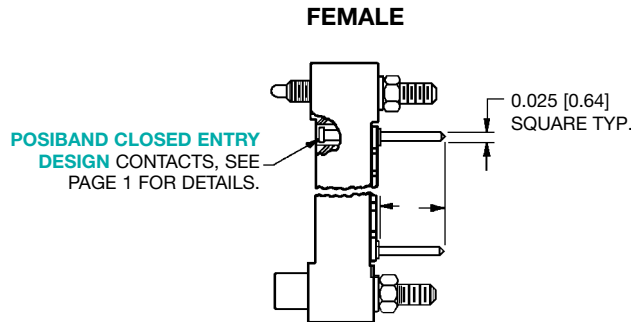

CONTACT CODE	L
WW1	0.225 [5.72]
WW2	0.355 [9.02]

For wrap post contacts, specify contact code in Step 4 of ordering information.

Typical Part Number:
SGM26SWW1T0000

COMPLIANT PRESS-IN PRINTED BOARD MOUNT TERMINATION*1
CODE 98

For compliant press-in contacts, specify contact code "98" in Step 4 of ordering information.

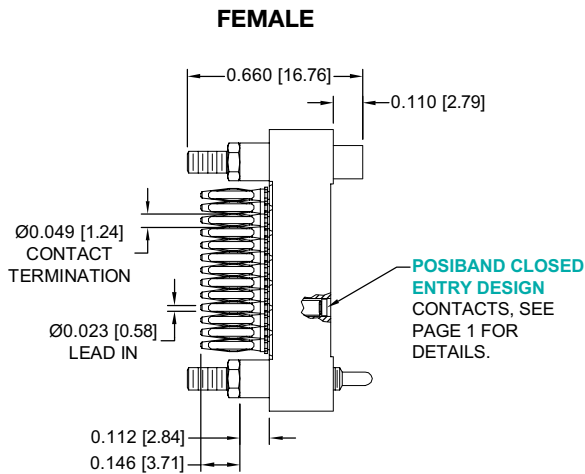

Typical Part Number:
SGM26S98T0000

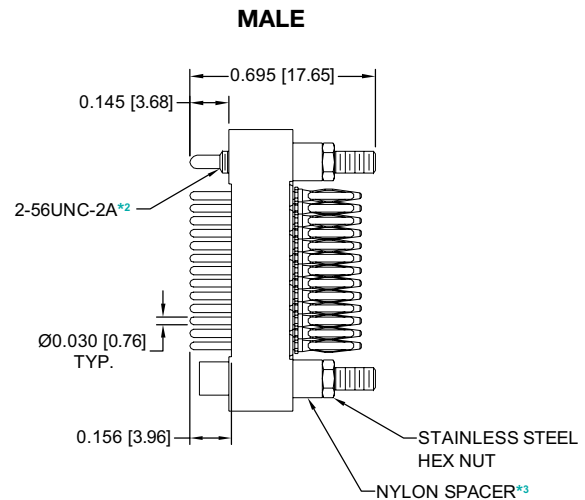

Typical Part Number:
SGM26M98T0000

NOTES:

*1 Positronic recommends the practice of using mounting hardware to secure connector to printed circuit board.

*2 M2X0.4 metric thread available.

*3 Stainless steel spacer available.

CONTACT HOLE PATTERNS:

For compliant press-in connector contact hole patterns, see page 21.

SUGGESTED PRINTED BOARD HOLE SIZES:

Suggest 0.105 [2.66] Ø hole in printed board for connector mounting holes.

NOTE: For suggested printed board recommended drill hole sizes, plating and finished hole sizes for compliant contact termination positions, see page 40.

For compliant press-in connector installation tools, see page 39.



Positronic
connectpositronic.com

SGM SERIES

INDUSTRIAL / MILITARY QUALITY

FIXED STRAIGHT PCB MOUNT / SOLDER CUP

High
Density
Rectangular

CONTACT HOLE POSITION DIMENSIONS AND PRINTED BOARD HOLE PATTERN FOR SGM AND SGMC SERIES

MATING FACE VIEW OF FEMALE OR REAR FACE VIEW OF MALE

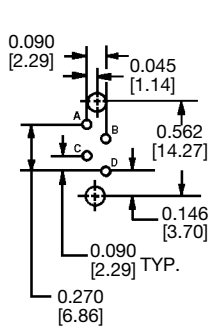

SGM 4
SGMC 4

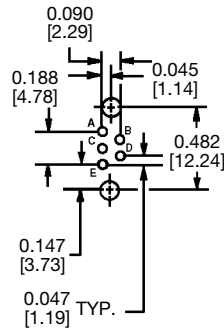

SGM 5

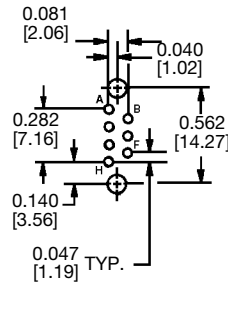

SGM 7
SGMC 7

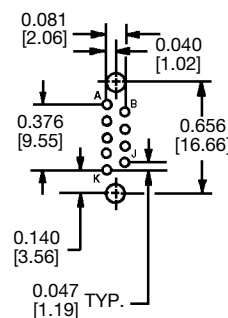

SGM 9
SGMC 9

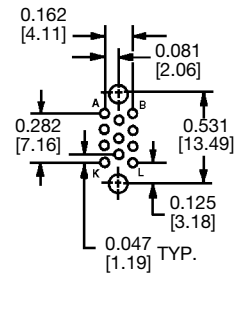

SGM 11

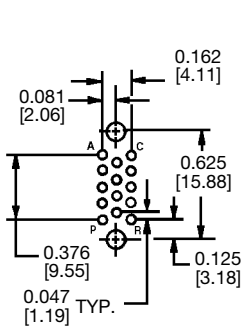

SGM 14
SGMC 14

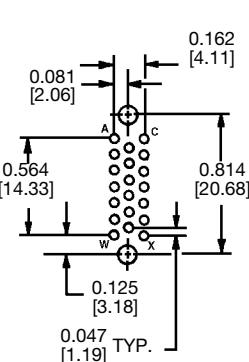

SGM 20
SGMC 20

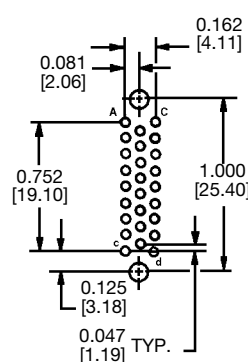

SGM 26
SGMC 26

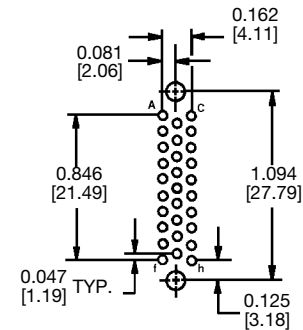

SGM 29

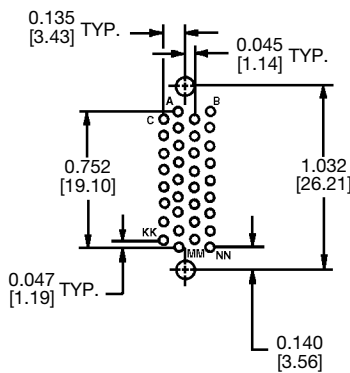

SGM 34
SGMC 34

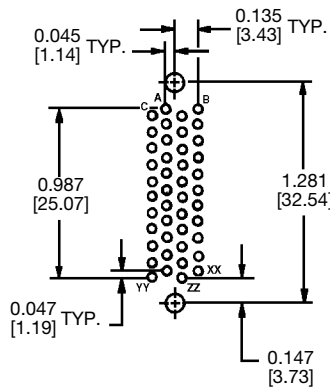

SGM 44
SGMC 44

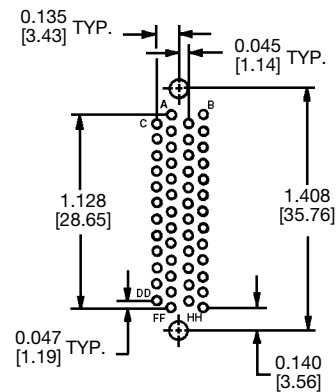

SGM 50
SGMC 50

SUGGESTED PRINTED BOARD HOLE SIZES:

Suggest 0.105 [2.66] Ø holes in printed board for connector mounting holes
Suggest 0.040 [1.01] Ø holes in printed board for contact terminations



ORDERING INFORMATION - CODE NUMBERING SYSTEM

Specify Complete Connector By Selecting An Option From Step 1 Through 9

STEP	1	2	3	4	5	6	7	8	9	10
EXAMPLE	SGM	26	S	SC	N	0	0	J	0	-14
STEP 1 - BASIC SERIES SGM series										STEP 10 - SPECIAL OPTIONS FOR SPECIAL OPTIONS, SEE SPECIAL OPTIONS APPENDIX ON PAGE 41.
STEP 2 - CONNECTOR VARIANTS 4, 5, 7, 9, 11, 14, 20, 26, 29, 34, 44, 50										*1 STEP 9 - ADDITIONAL FEATURES B – For black anodized aluminum parts. R – For yellow chromate coating on aluminum parts. *3 V – Lock tab. *3 VL – Actuation lock lever. M – Jackscrews with metric threads. 0 – If no additional options are required.
STEP 3 - CONNECTOR GENDER M - Male S - Female - PosiBand closed entry contacts, see page 1 for more information.										*1 STEP 8 - BACKSHELL J – Top opening backshell offered on all variants except 5 and 11. 0 – If no backshell are required.
STEP 4 - CONTACT TERMINATION TYPE All female contacts “closed entry” design DS3 – Straight solder 0.093 [2.36] DS4 – Straight solder 0.125 [3.18] DS5 – Straight solder 0.156 [3.96] DS6 – Straight solder 0.187 [4.75] SC – Solder cup WW1 – Wrap post 0.225 [5.72] WW2 – Wrap post 0.355 [9.02] 98 – Straight printed circuit board mount, compliant press-in.										*1 STEP 7 - CODING (KEYING) POSITIONS OF CONNECTOR HOUSING (SHELLS) Select letter to designate position of male pin or female slot for coding system. A, B, C, D, E, F, G 0 – If no coding is required or if no connector housings are required.
*1 STEP 5 - POLARIZING GUIDES AND JACKSCREW SYSTEMS N – Polarizing guides. NSS – Stainless steel polarizing guides. T – Fixed jackscrews. E – Rotating jackscrews with knobs. E1 – Rotating jackscrews used with backshell only. ESS – Short rotating jackscrews. 0 – If no polarizing guides or jackscrews are required.										*1 STEP 6 - CONNECTOR HOUSING (SHELLS) *2 P – Male shell. *2 R – Female shell. 0 – If no connector housings are required.
										NOTE: *1 For details of items listed in steps 5 through 9, see Accessories section on pages 30-36. *2 Contact Technical Sales for availability of 5, 11 and 29 connector variants. *3 Select ‘0’ in Step 6 when selecting ‘V’ and ‘VL’ options.

Do you need 2-D drawings or 3-D models?

See page 16 for more information!



Positronic
connectpositronic.com

SMPL SERIES

INDUSTRIAL / MILITARY QUALITY

FIXED RIGHT ANGLE PCB MOUNT TERMINATION

High
Density
Rectangular

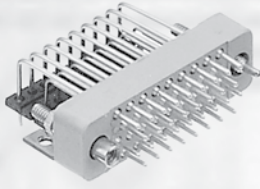

- ✓ High reliability connectors with fixed contacts.
- ✓ Contacts are high density size 22.
- ✓ Terminations: right angle (90°) solder printed board mount.
See pages 25 for details.
- ✓ Female closed entry contacts utilize the “PosiBand®” system.
See page 1 for details.
- ✓ Current ratings: signal level to 13 amperes.
See temperature rise curves on page 2 for details.
- ✓ Twelve connector variants, 4 - 50 contacts.
- ✓ A multitude of polarization and connector coding (keying) options. See pages 30-34 for details.
- ✓ Intermateable with SGMC and SGM series.
See page 5 for SGMC series and page 15 for SGM series.
- ✓ Thermocouple contact options available.
- ✓ A wide variety of options and accessories.



Conforms to:

- MIL-DTL-28748

Telecommunication:

- UL File # E49351

TECHNICAL CHARACTERISTICS

MATERIALS AND FINISHES:

Connector insert:	Glass filled DAP per ASTM-D-5948 type SDG-F. Grey color is standard, black or green available.
Fixed Contacts:	Precision machined copper alloy. 0.000015 inch [0.38 μ] gold over nickel. Other finishes available upon request, see page 41 for details.
Polarizing Guides:	Copper alloy with nickel plate or passivated stainless steel.
Jackscrew System:	Passivated stainless steel.
Mounting Bracket:	Phosphor bronze with zinc plate and chromate seal.

Alignment Bar:	Nylon, black.
Quick Disconnect Locking Device:	Actuation lock lever and lock tab, copper alloy with nickel plate.

MECHANICAL CHARACTERISTICS:

Fixed Contacts:	Size 22, male 0.030 inch [0.76 mm] mating diameter. Female – PosiBand closed entry design, see page 1 for details.
Contact Retention in Connector Insert:	6 lbs. [26.5N] minimum.
Contact Termination:	0.020 inch [0.51 mm] termination diameter.
Locking Systems:	Friction, quick disconnect locking device and jackscrews.

High
Density
Rectangular

SMPL SERIES
INDUSTRIAL / MILITARY QUALITY
FIXED RIGHT ANGLE PCB MOUNT TERMINATION



Positronic
connectpositronic.com

TECHNICAL CHARACTERISTICS, continued

continued from previous page. . . .

MECHANICAL CHARACTERISTICS, continued:

Polarization:	Polarized guides and jackscrew system.
Coding (Keying) Device:	Pin and slot system; male and female guide system.
Mechanical Operations:	1000 operations per IEC 60512-5.
Jackscrews:	Standard threads, 2-56 UNC. M2X0.4 metric threads available.

Flash over Voltage:	2200 V.AC (rms)
Test Voltage:	1000 V.AC (rms)
Insulation Resistance:	5 G ohms, minimum.
Clearance and Creepage Distance:	0.028 inch [0.71 mm], minimum.
Working Temperature:	-55°C to 135°C
Working Voltage:	250 V.AC (rms)

ELECTRICAL CHARACTERISTICS:

Contact Current Rating, Tested per UL 1977:

- 13 amperes, 2 contacts energized.
- 10 amperes, 6 contacts energized.
- 6 amperes, 26 contacts energized.
- 5 amperes, 104 contacts energized

See temperature rise curves on page 2 for details.

Initial Contact Resistance: 0.004 ohms, maximum.

THERMOCOUPLE CONTACTS:

Right angle (90°) printed board mount contacts are available, please contact Technical Sales for details.

Straight printed board mount contacts are available in SGM series, see page 16 for details.

Size 22 removable crimp contacts are available in SGMC series, see page 12 for details.

*Visit our web site for the latest catalog updates and supplements at
<https://www.connectpositronic.com/catalogs/>*

Do you need 2-D drawings or 3-D models?

Once you have made a connector selection, contact Technical Sales if you would like a 2-D drawing or 3-D model. If we do not have your specific part number on file, we can create one for you. Or, please visit www.connectpositronic.com and use the search function.

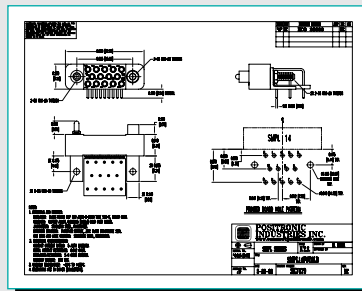

2-D Drawing

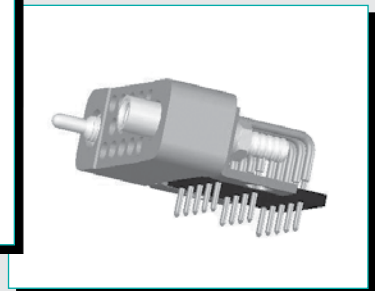

3-D Model



Positronic
connectpositronic.com

SMPL SERIES

INDUSTRIAL / MILITARY QUALITY

FIXED RIGHT ANGLE PCB MOUNT TERMINATION

High
Density
Rectangular

RIGHT ANGLE (90°) SOLDER PRINTED BOARD MOUNT TERMINATION CODE 0

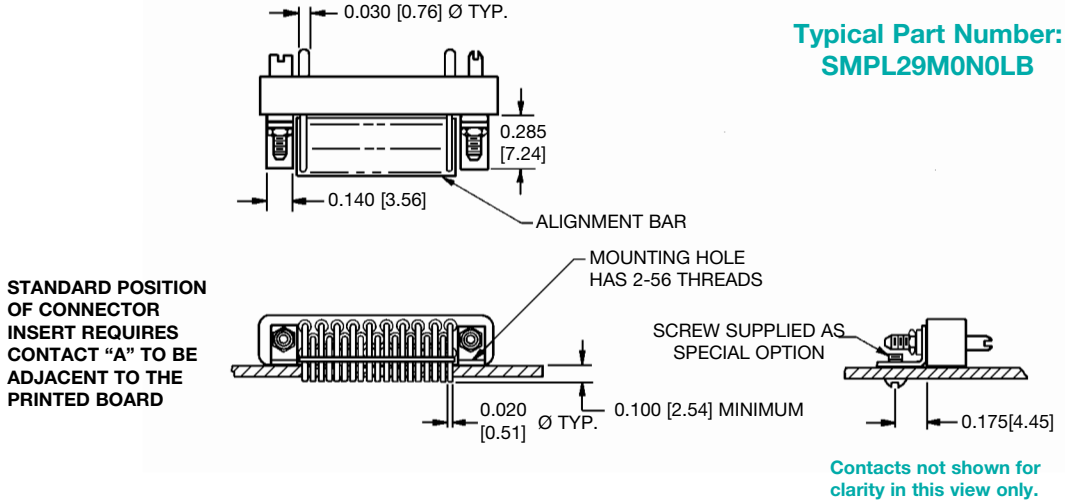

NOTE:

Add 0.030 [0.76] to the hole location dimension 0.175 [4.48] when mounting bracket (Code LB) and locking tab (Code V) are used in combination on connector.

CONNECTOR INSERT DIMENSIONS:

For SMPL series connector insert dimensions, refer to page 17 in SGM series.

MOUNTING BRACKET CODE LB

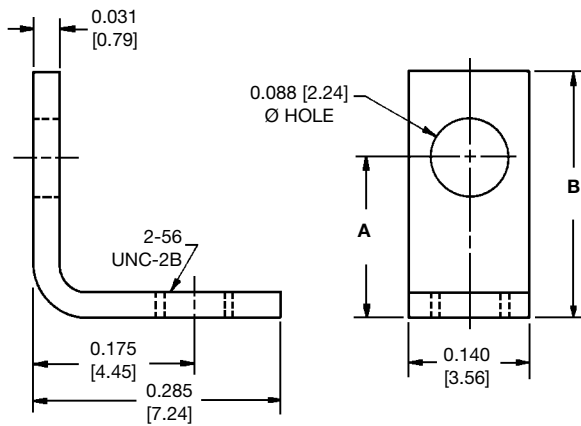

PART NUMBER	A	B	CONNECTOR VARIANTS
80213-0	0.105 [2.67]	0.205 [5.21]	4, 5, 7, 9
80213-1	0.140 [3.56]	0.240 [6.10]	11, 14, 20, 26, 29
80213-2	0.195 [4.95]	0.295 [7.49]	34, 44, 50

ALIGNMENT BAR DIMENSIONS

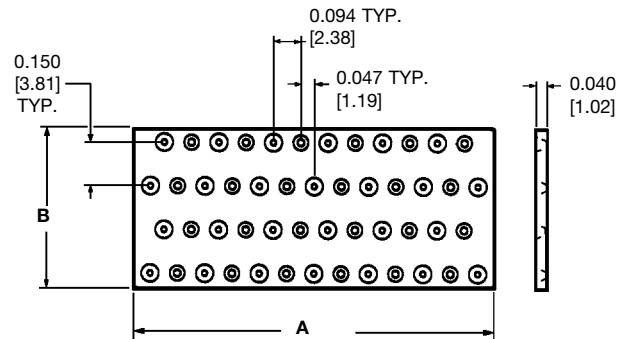

SIZE	A	B
5	0.314 [7.98]	0.290 [7.37]
7	0.394 [10.01]	0.290 [7.37]
9	0.488 [12.40]	0.290 [7.37]
11	0.364 [9.25]	0.415 [10.54]
14	0.456 [11.58]	0.415 [10.54]
20	0.646 [16.41]	0.415 [10.54]
26	0.832 [21.13]	0.415 [10.54]
29	0.926 [23.52]	0.415 [10.54]
34	0.864 [21.95]	0.550 [13.97]
44	1.112 [28.24]	0.550 [13.97]
50	1.240 [31.50]	0.550 [13.97]



RIGHT ANGLE (90°) PRINTED BOARD HOLE PATTERN

HOLE IDENTIFICATION SHOWN FOR MALE CONNECTOR; USE MIRROR IMAGE FOR FEMALE CONNECTOR.

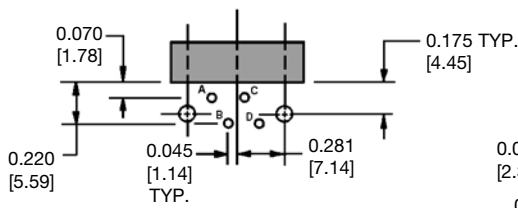

SMPL 4

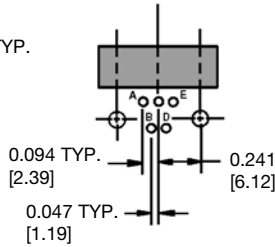

SMPL 5

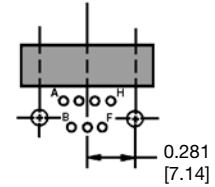

SMPL 7

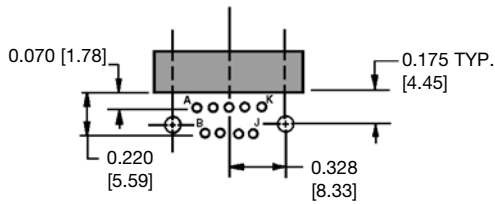

SMPL 9

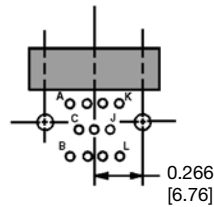

SMPL 11

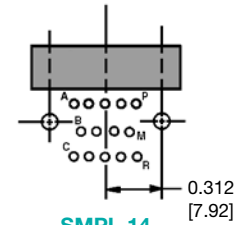

SMPL 14

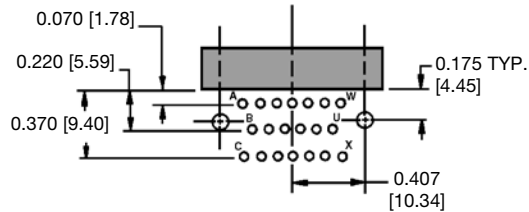

SMPL 20

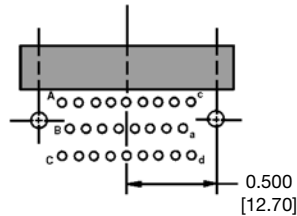

SMPL 26

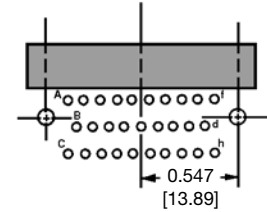

SMPL 29

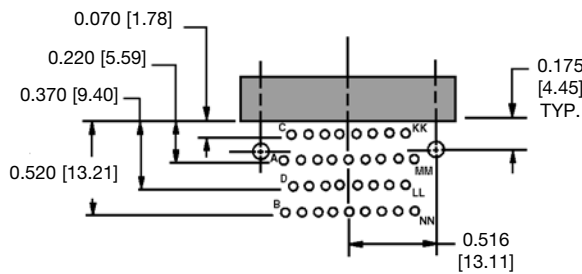

SMPL 34

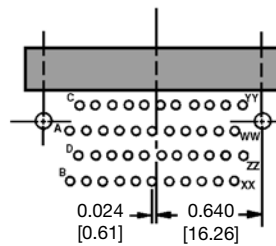

SMPL 44

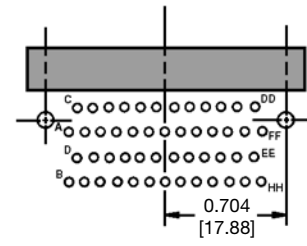

SMPL 50

SUGGESTED PRINTED BOARD HOLE SIZES:

Suggest 0.105 [2.66] Ø holes in printed board for connector mounting holes
Suggest 0.040 [1.01] Ø holes in printed board for contact terminations
Add 0.030 [0.76] to the hole location dimension 0.175 [4.48] when mounting bracket (Code LB) and locking tab (Code V) are used in combination on connector.



ORDERING INFORMATION - CODE NUMBERING SYSTEM

Specify Complete Connector By Selecting An Option From Step 1 Through 7

STEP	1	2	3	4	5	6	7	8
EXAMPLE	SMPL	14	S	0	T	0	LB	-14

STEP 1 - BASIC SERIES

SMPL series.

STEP 2 - CONNECTOR VARIANTS

4, 5, 7, 9, 11, 14, 20, 26,
29, 34, 44, 50

STEP 3 - CONNECTOR GENDER

M - Male
S - Female - PosiBand closed entry contacts, see
page 1 for more information.

STEP 4 - CONTACT TERMINATION TYPE

0 - Standard termination, right angle (90°).

*1 STEP 5 - POLARIZING GUIDES AND JACKSCREW SYSTEMS

N - Polarizing guides.
NSS - Stainless steel polarizing guides.
T - Fixed jackscrews.
0 - If no polarizing guides or jackscrews are required.

STEP 8 - SPECIAL OPTIONS

**FOR SPECIAL OPTIONS, SEE SPECIAL
OPTIONS APPENDIX ON PAGE 41.**

STEP 7 - MOUNTING BRACKETS

LB - Mounting bracket.
0 - If no mounting bracket is required.

*1 STEP 6 - QUICK DISCONNECT LOCKING DEVICES

V - Lock tab.
VL - Actuation lock lever.
0 - If no locking devices are required.

NOTE:

*1 For details of items listed in steps 5 through 6,
see Accessories section on pages 30-36.

Do you need 2-D drawings or 3-D models?

See page 24 for more information!

*Visit our web site for the latest catalog updates and supplements at
<https://www.connectpositronic.com/catalogs/>*



U N I Q U E F E A T U R E S E C T I O N



Positronic is **known** around the world **for offering** our customers **flexibility** when choosing connectors.

In addition to allowing **customers** to **create** part numbers for **particular applications**, Positronic offers a **wide variety** of features and accessories within our products.

Positronic is **able** to modify existing products **to meet unique customer requirements**. We are also eager to develop **custom connectors** to customer requirements. If you do not find what you need in this catalog, please contact us for **assistance**.

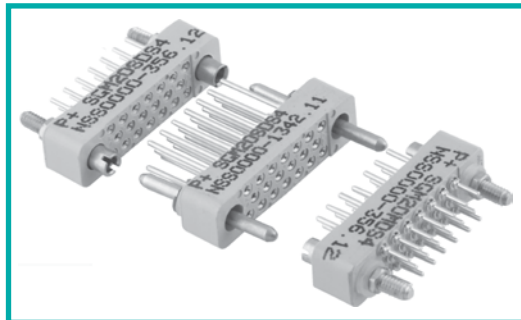

**LOW PROFILE SPACE SAVING
HIGH RELIABILITY MEZZANINE CONNECTOR**
SGM SERIES

*SGM connectors can be **used to stack multiple printed circuit boards** in applications requiring rugged, high density connectors.*

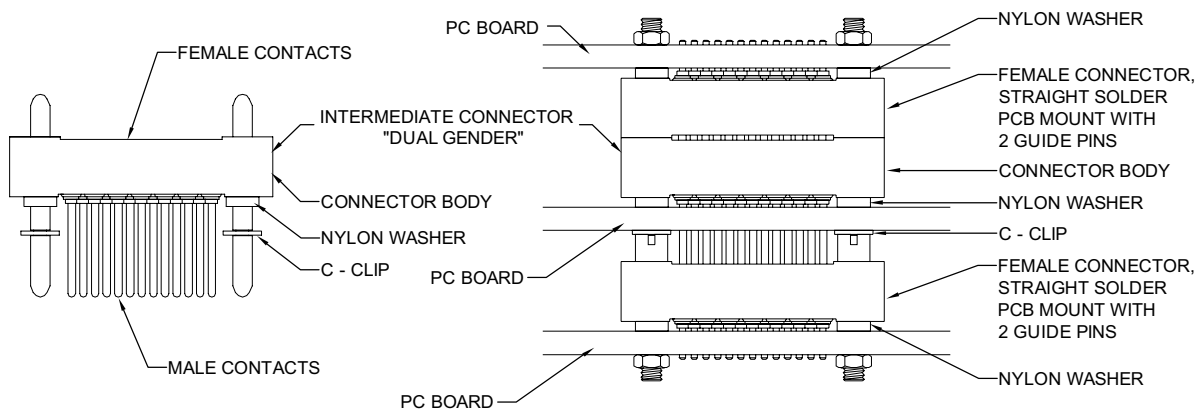

FOR DETAILED INFORMATION AND OPTIONS, CONTACT TECHNICAL SALES



CUSTOMER SPECIFIED CONTACT TERMINATION LENGTH

Positronic can supply High Density Rectangular connectors with customer specified termination lengths. We have a wide variety of options available.

STRAIGHT PRINTED BOARD MOUNT

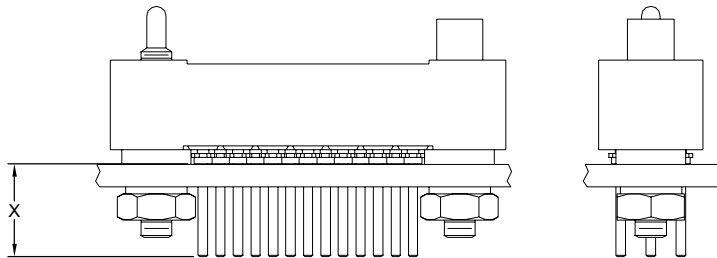

RIGHT ANGLE (90°) PRINTED BOARD MOUNT

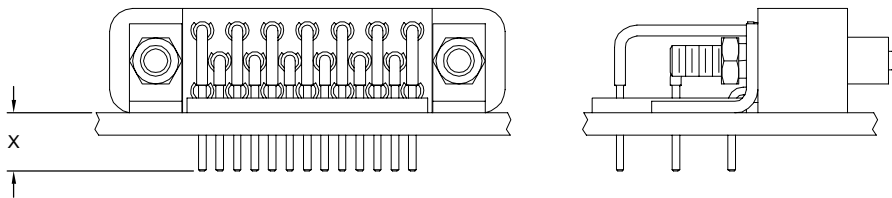

“X” contact termination lengths can be custom designed to fit your application requirements.

CONTACT TECHNICAL SALES FOR MORE INFORMATION!

FLUSH PANEL CONNECTOR MOUNTING BRACKETS

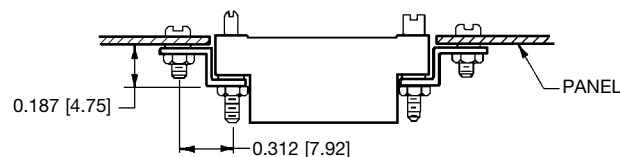

PART NUMBER 80217-0



POLARIZATION & CODING (KEYING) OPTIONS

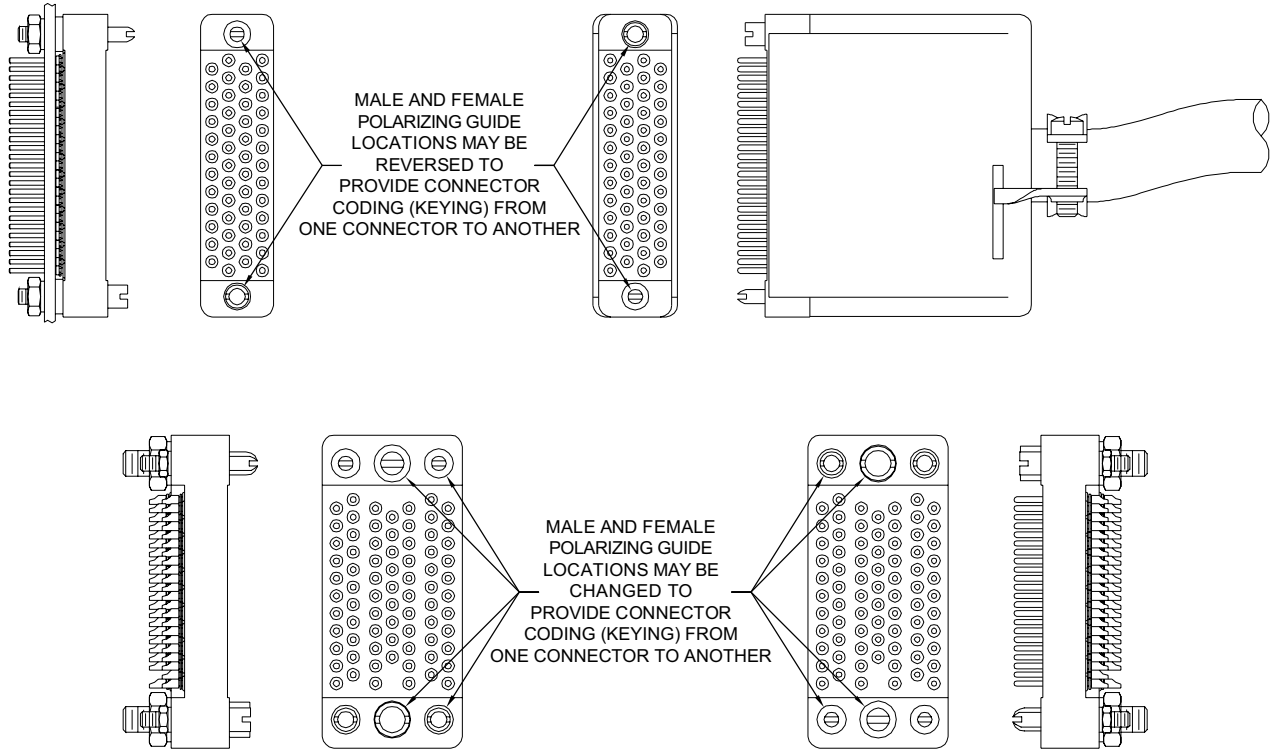

ACCESSORIES SECTION

PANEL CUT-OUT DIMENSIONS
FOR USE WITH SGMC OR SGM SERIES CONNECTORS

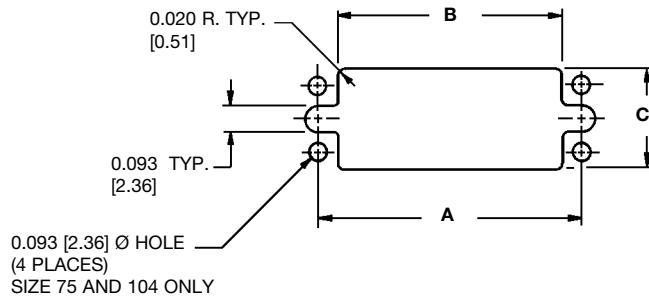

SIZE	A	B MIN.	C MIN.
4	0.562 [14.27]	0.390 [9.91]	0.215 [5.46]
5	0.482 [12.24]	0.315 [8.00]	0.215 [5.46]
7	0.562 [14.27]	0.397 [10.08]	0.215 [5.46]
9	0.656 [16.66]	0.495 [12.57]	0.215 [5.46]
11	0.531 [13.49]	0.401 [10.19]	0.285 [7.24]
14	0.625 [15.88]	0.510 [12.95]	0.285 [7.24]
20	0.814 [20.68]	0.700 [17.78]	0.285 [7.24]
26	1.000 [25.40]	0.885 [22.48]	0.285 [7.24]
29	1.094 [27.79]	0.959 [24.36]	0.285 [7.24]
34	1.032 [26.21]	0.867 [22.02]	0.395 [10.03]
44	1.281 [32.54]	1.105 [28.07]	0.395 [10.03]
50	1.408 [35.76]	1.235 [31.37]	0.395 [10.03]
75	1.375 [34.93]	1.145 [29.08]	0.755 [19.18]
104	1.750 [44.45]	1.520 [37.47]	0.755 [19.18]



POLARIZING GUIDES
CODE N OR CODE NSS

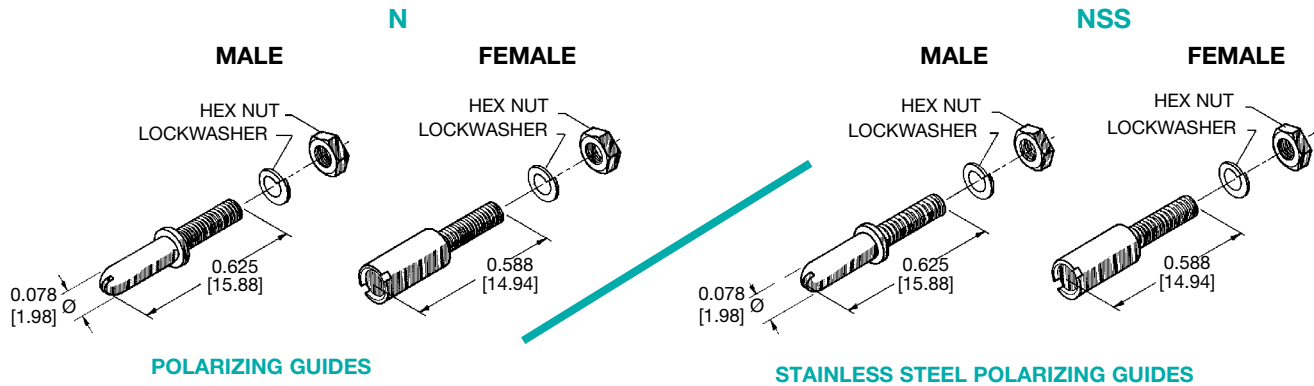

FIXED AND ROTATING JACKSCREW SYSTEMS
CODE T, CODE E OR CODE ESS

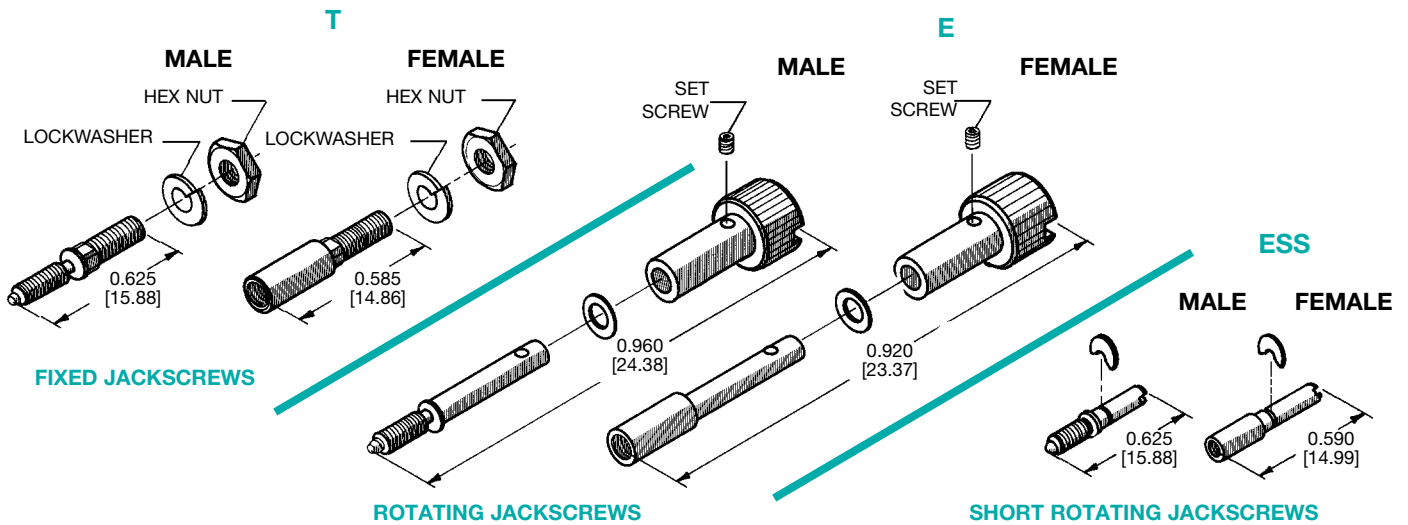

POLARIZING GUIDE AND JACKSCREW THREAD AVAILABILITY CHART
CODE N, CODE NSS, CODE T, CODE E OR CODE ESS

THREAD OPTIONS	POLARIZING GUIDES				FIXED AND ROTATING JACKSCREWS					
	N		NSS		T		E		*1 ESS	
	4 - 50 VARIANTS	75 &104 VARIANTS	4 - 50 VARIANTS	75 &104 VARIANTS	4 - 50 VARIANTS	75 &104 VARIANTS	4 - 50 VARIANTS	75 &104 VARIANTS	4 - 50 VARIANTS	75 &104 VARIANTS
2-56 THREAD	SUPPLIED AS STANDARD	---	SUPPLIED AS STANDARD	---	SUPPLIED AS STANDARD	---	SUPPLIED AS STANDARD	---	SUPPLIED AS STANDARD	---
M2x0.4 METRIC THREAD	AVAILABLE	---	AVAILABLE	---	AVAILABLE	---	AVAILABLE	---	AVAILABLE	---
6-32 THREAD	---	SUPPLIED AS STANDARD	---	SUPPLIED AS STANDARD	---	SUPPLIED AS STANDARD	---	SUPPLIED AS STANDARD	CONTACT TECHNICAL SALES FOR AVAILABILITY	
M3x0.5 METRIC THREAD	---	AVAILABLE	---	AVAILABLE	---	AVAILABLE	---	AVAILABLE	CONTACT TECHNICAL SALES FOR AVAILABILITY	
MATERIAL AND FINISH	COPPER ALLOY WITH NICKEL PLATE		STAINLESS STEEL PASSIVATED		STAINLESS STEEL PASSIVATED					



POLARIZING GUIDE
FOR USE WITH 4 TO 50 CONTACTS VARIANTS
CODE N OR CODE NSS
QUALIFIED TO MIL-DTL-28748

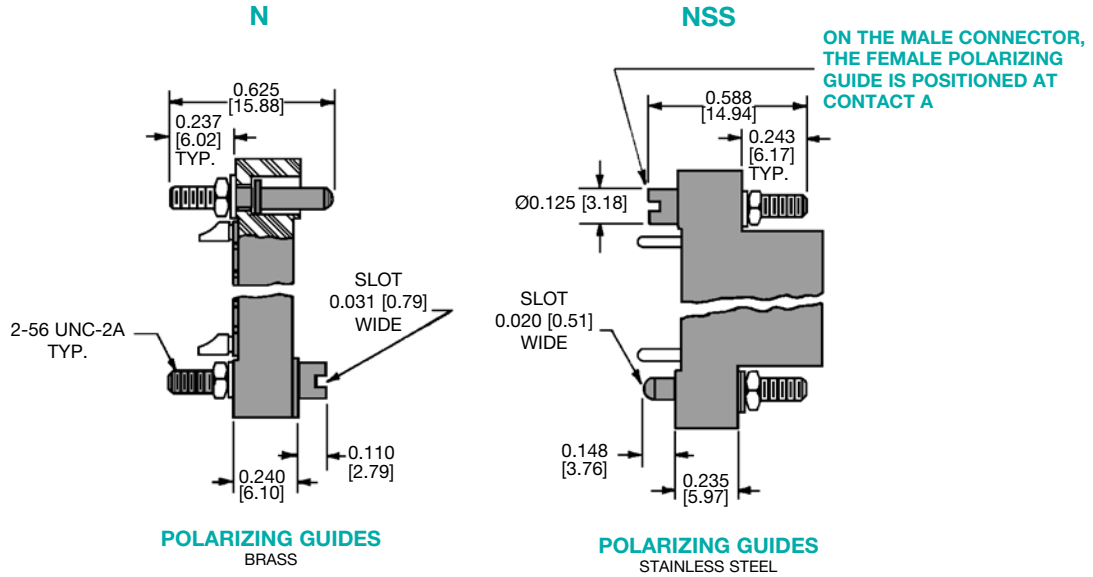

NOTES:

Alternative lengths of polarizing guides are available as special options, contact Technical Sales.
M2x0.4 metric threads available, see chart on page 31.

POLARIZING GUIDE
FOR USE WITH SGMC 75 OR SGMC 104 CONTACT VARIANTS
CODE NSS

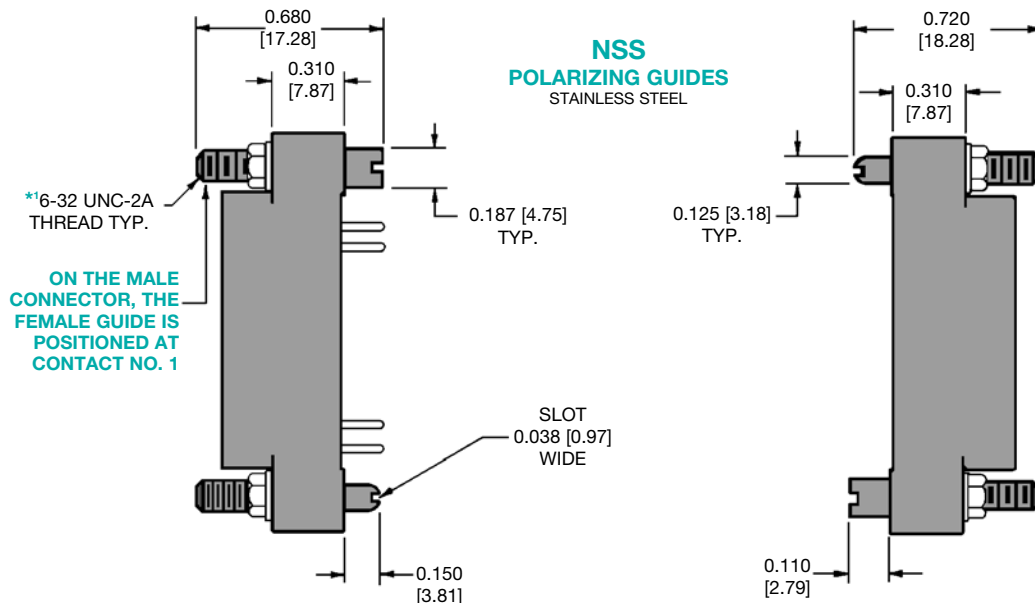

NOTE:

*1 M3x0.5 metric threads available, see chart on page 31.



JACKSCREW SYSTEM

FOR USE WITH 4 TO 50 CONTACTS VARIANTS

CODE T, CODE E, CODE ESS, CODE ESS-756.2 OR CODE E-793.4

QUALIFIED TO MIL-DTL-28748

T

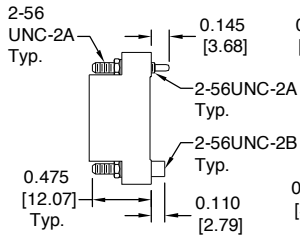

FIXED JACKSCROWS
STAINLESS STEEL

E

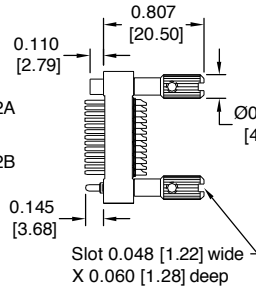

ROTATING JACKSCROWS
STAINLESS STEEL WITH ALUMINUM KNOBS

ESS

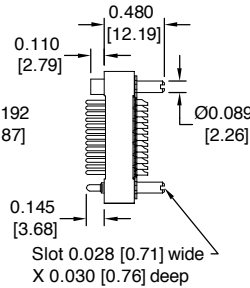

ROTATING JACKSCROWS
STAINLESS STEEL

ESS-756.2

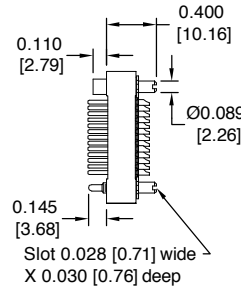

ROTATING JACKSCROWS
STAINLESS STEEL
CONSULT TECHNICAL SALES FOR ORDERING INFORMATION

E-793.4

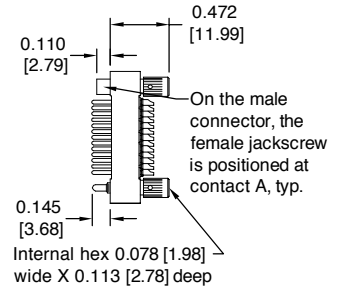

ROTATING JACKSCROWS
STAINLESS STEEL WITH STAINLESS STEEL KNOBS
CONSULT TECHNICAL SALES FOR ORDERING INFORMATION

NOTES:

Alternative lengths of jackscrows are available as special options, contact Technical Sales.
M3x0.5 metric threads available, see chart on page 31.

JACKSCREW SYSTEM

FOR USE WITH SGMC 75 OR SGMC 104 CONTACT VARIANTS

CODE T OR CODE E

T

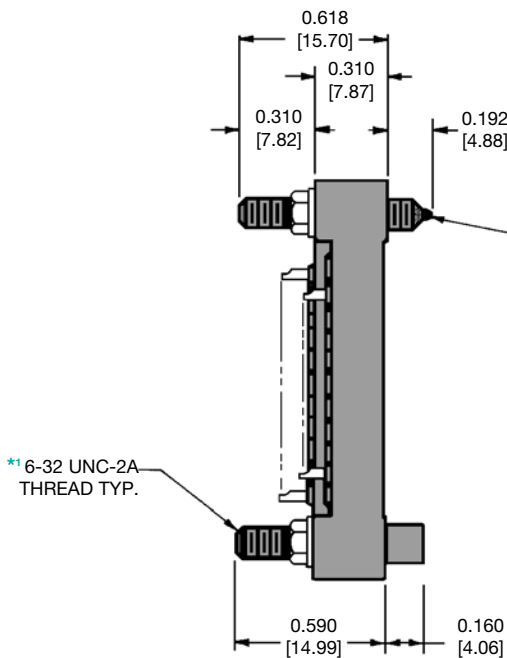

FIXED JACKSCROWS
STAINLESS STEEL

E

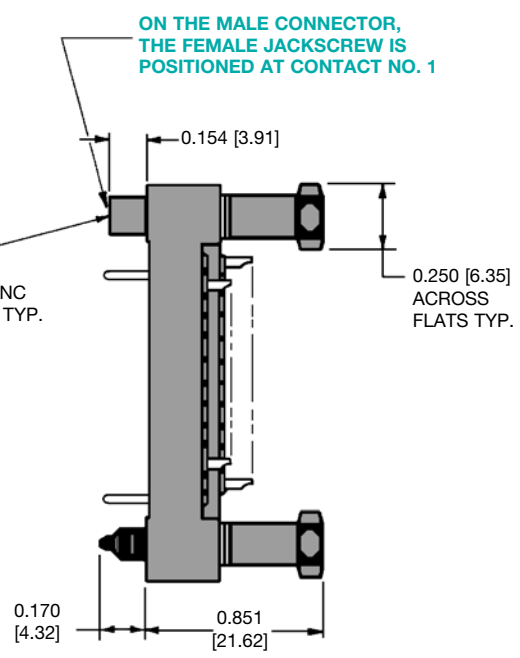

ROTATING JACKSCROWS
STAINLESS STEEL

NOTE:

*1 M3x0.5 metric threads available, see chart on page 31.



FEMALE

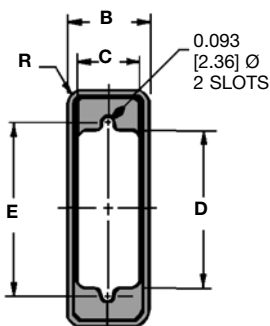
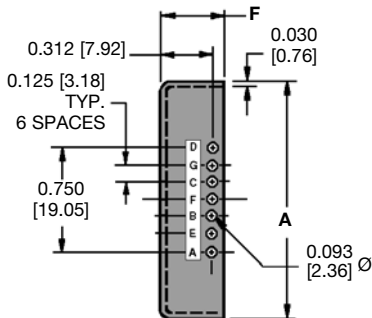
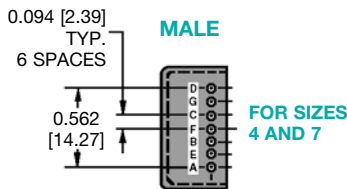
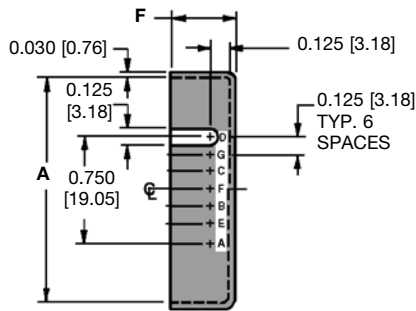
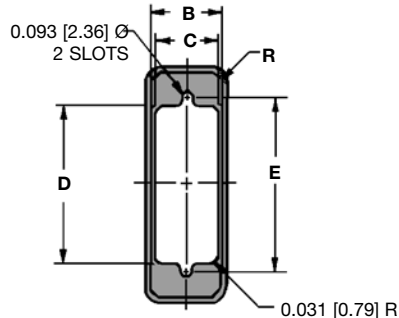
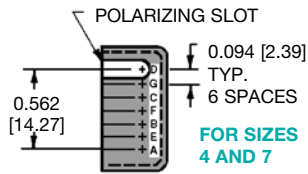

CONNECTOR HOUSING (SHELLS)

CODE R OR CODE P

QUALIFIED TO MIL-DTL-28748

CODING (KEYING) DEVICE OPTIONS

Coding (keying) is accomplished with connector housings by a pin and slot system. Female connector housings are slotted to accept stainless steel polarizing pins mounted on the male connector housings.

There are seven coding positions available which are designated by the letters A, B, C, D, E, F or G. Non-coded connector housings are designated by "0" and are supplied without slot and pin. See ordering chart. For non Mil-Spec shells the polarization feature location shall be: slot to the left, pin to the right, when the connector is held vertically with contact position A or 1 at the top and the mating face visible.

**FEMALE
CODE R**

PART NUMBER	A MIN.	B MIN.	C MIN.	D MIN.	E	F	R
SG4000R000	0.875 [22.23]	0.305 [7.75]	0.230 [5.84]	0.430 [10.92]	0.562 [14.27]	0.437 [11.10]	0.031 [0.79]
SG7000R000	0.875 [22.23]	0.305 [7.75]	0.230 [5.84]	0.430 [10.92]	0.562 [14.27]	0.437 [11.10]	0.031 [0.79]
SG14000R000	0.975 [24.77]	0.375 [9.53]	0.300 [7.62]	0.530 [13.46]	0.625 [15.88]	0.437 [11.10]	0.062 [1.57]
SG20000R000	1.165 [29.59]	0.375 [9.53]	0.300 [7.62]	0.730 [18.54]	0.814 [20.68]	0.437 [11.10]	0.062 [1.57]
SG26000R000	1.350 [34.29]	0.375 [9.53]	0.300 [7.62]	0.910 [23.11]	1.000 [25.40]	0.437 [11.10]	0.062 [1.57]
SG34000R000	1.344 [34.14]	0.480 [12.19]	0.410 [10.41]	0.900 [22.86]	1.032 [26.21]	0.437 [11.10]	0.062 [1.57]
SG44000R000	1.595 [40.51]	0.480 [12.19]	0.410 [10.41]	1.140 [28.96]	1.281 [32.54]	0.437 [11.10]	0.062 [1.57]
SG50000R000	1.715 [43.56]	0.480 [12.19]	0.410 [10.41]	1.270 [32.26]	1.408 [35.76]	0.437 [11.10]	0.062 [1.57]
SG75000R000	1.775 [45.09]	0.840 [21.34]	0.770 [19.56]	1.180 [29.97]	1.375 [34.93]	0.512 [13.00]	0.062 [1.57]
SG104000R000	2.160 [54.86]	0.840 [21.34]	0.770 [19.56]	1.545 [39.24]	1.750 [44.45]	0.512 [13.00]	0.062 [1.57]

**MALE
CODE P**

PART NUMBER	A MAX.	B MAX.	C MIN.	D MIN.	E	F	R
SG4000P000	0.870 [22.10]	0.300 [7.62]	0.230 [5.84]	0.430 [10.92]	0.562 [14.27]	0.437 [11.10]	0.031 [0.79]
SG7000P000	0.870 [22.10]	0.300 [7.62]	0.230 [5.84]	0.430 [10.92]	0.562 [14.27]	0.437 [11.10]	0.031 [0.79]
SG14000P000	0.970 [24.64]	0.370 [9.40]	0.300 [7.62]	0.530 [13.46]	0.625 [15.88]	0.437 [11.10]	0.062 [1.57]
SG20000P000	1.160 [29.46]	0.370 [9.40]	0.300 [7.62]	0.730 [18.54]	0.814 [20.68]	0.437 [11.10]	0.062 [1.57]
SG26000P000	1.345 [34.16]	0.370 [9.40]	0.300 [7.62]	0.910 [23.11]	1.000 [25.40]	0.437 [11.10]	0.062 [1.57]
SG34000P000	1.340 [34.04]	0.480 [12.19]	0.410 [10.41]	0.900 [22.86]	1.032 [26.21]	0.437 [11.10]	0.062 [1.57]
SG44000P000	1.590 [40.39]	0.480 [12.19]	0.410 [10.41]	1.140 [28.96]	1.281 [32.54]	0.437 [11.10]	0.062 [1.57]
SG50000P000	1.710 [40.59]	0.480 [12.19]	0.410 [10.41]	1.270 [32.26]	1.408 [35.76]	0.437 [11.10]	0.062 [1.57]
SG75000P000	1.770 [44.96]	0.840 [21.34]	0.770 [19.56]	1.180 [29.97]	1.375 [34.93]	0.512 [13.00]	0.062 [1.57]
SG104000P000	2.145 [54.48]	0.840 [21.34]	0.770 [19.56]	1.545 [39.24]	1.750 [44.45]	0.512 [13.00]	0.062 [1.57]



ALUMINUM BACKSHELL
FOR USE WITH 4 TO 50 CONTACTS VARIANTS
CODE J
QUALIFIED TO MIL-DTL-28748

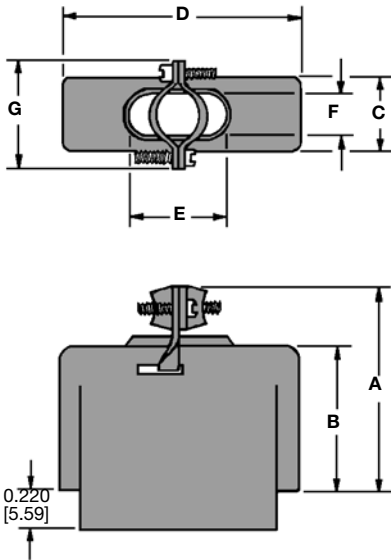

PART NUMBER	DIMENSIONS					CABLE OPENING	
	A	B	C	D	G	E	F
SG400000J0	0.943 [23.95]	0.750 [19.05]	0.250 [6.35]	0.780 [19.81]	0.410 [10.41]	0.255 [6.48]	0.188 [4.78]
SG700000J0	0.943 [23.95]	0.750 [19.05]	0.250 [6.35]	0.780 [19.81]	0.410 [10.41]	0.255 [6.48]	0.188 [4.78]
SG900000J0	1.087 [27.61]	0.750 [19.05]	0.272 [6.91]	0.880 [22.35]	0.550 [13.97]	0.375 [9.53]	0.190 [4.83]
SG1400000J0	1.087 [27.61]	0.750 [19.05]	0.340 [8.64]	0.886 [22.50]	0.550 [13.97]	0.375 [9.53]	0.255 [6.48]
SG2000000J0	1.087 [27.61]	0.750 [19.05]	0.340 [8.64]	1.062 [26.97]	0.550 [13.97]	0.375 [9.53]	0.250 [6.35]
SG2600000J0	1.076 [27.33]	0.750 [19.05]	0.340 [8.64]	1.250 [31.75]	0.550 [13.97]	0.406 [10.31]	0.250 [6.35]
SG2900000J0	1.087 [27.61]	0.750 [19.05]	0.340 [8.64]	1.344 [34.14]	0.550 [13.97]	0.406 [10.31]	0.250 [6.35]
SG3400000J0	1.077 [27.36]	0.750 [19.05]	0.453 [11.51]	1.250 [31.75]	0.710 [18.03]	0.750 [19.05]	0.375 [9.53]
SG4400000J0	1.527 [38.79]	1.190 [30.23]	0.450 [11.43]	1.500 [38.10]	0.710 [18.03]	0.750 [19.05]	0.380 [9.65]
SG5000000J0	1.527 [38.79]	1.190 [30.23]	0.450 [11.43]	1.620 [41.15]	0.710 [18.03]	1.000 [25.40]	0.388 [9.86]

ALUMINUM BACKSHELL WITH JACKSCREW SYSTEM
FOR USE WITH 4 TO 50 CONTACTS VARIANTS
CODE E1 (IN STEP 5) AND J (IN STEP 8)
QUALIFIED TO MIL-DTL-28748

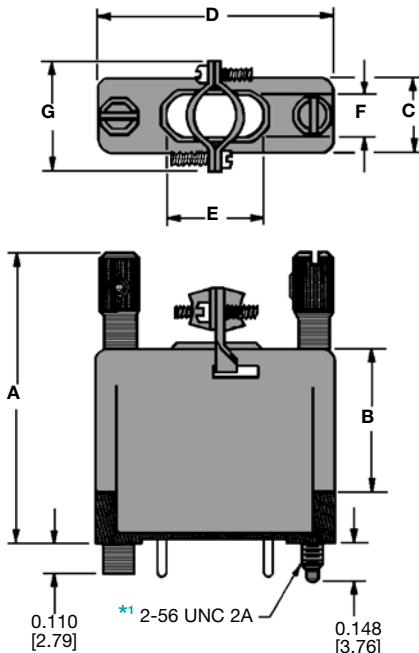

PART NUMBER	DIMENSIONS					CABLE OPENING	
	A	B	C	D	G	E	F
SG400E100J0	1.561 [39.65]	0.750 [19.05]	0.250 [6.35]	0.780 [19.81]	0.410 [10.41]	0.255 [6.48]	0.188 [4.78]
SG700E100J0	1.561 [39.65]	0.750 [19.05]	0.250 [6.35]	0.780 [19.81]	0.410 [10.41]	0.255 [6.48]	0.188 [4.78]
SG900E100J0	1.561 [39.65]	0.750 [19.05]	0.272 [6.91]	0.880 [22.35]	0.550 [13.97]	0.375 [9.53]	0.190 [4.83]
SG1400E100J0	1.561 [39.65]	0.750 [19.05]	0.340 [8.64]	0.886 [22.50]	0.550 [13.97]	0.375 [9.53]	0.255 [6.48]
SG2000E100J0	1.561 [39.65]	0.750 [19.05]	0.340 [8.64]	1.062 [26.97]	0.550 [13.97]	0.375 [9.53]	0.250 [6.35]
SG2600E100J0	1.561 [39.65]	0.750 [19.05]	0.340 [8.64]	1.250 [31.75]	0.550 [13.97]	0.406 [10.31]	0.250 [6.35]
SG2900E100J0	1.561 [39.65]	0.750 [19.05]	0.340 [8.64]	1.344 [34.14]	0.550 [13.97]	0.406 [10.31]	0.250 [6.35]
SG3400E100J0	1.561 [39.65]	0.750 [19.05]	0.453 [11.51]	1.250 [31.75]	0.710 [18.03]	0.750 [19.05]	0.375 [9.53]
SG4400E100J0	2.001 [50.83]	1.190 [30.23]	0.450 [11.43]	1.500 [38.10]	0.710 [18.03]	0.750 [19.05]	0.380 [9.65]
SG5000E100J0	2.001 [50.83]	1.190 [30.23]	0.450 [11.43]	1.620 [41.15]	0.710 [18.03]	1.000 [25.40]	0.388 [9.86]

NOTE:

*1 M2x0.4 metric threads available, see chart on page 31.



FULL ACCESS ALUMINUM BACKSHELL WITH JACKSCREW SYSTEM

Hinged cover allows access to the inside of the hood while still installed on the connector

FOR USE WITH 104 CONTACTS VARIANTS

CODE Z OR CODE V

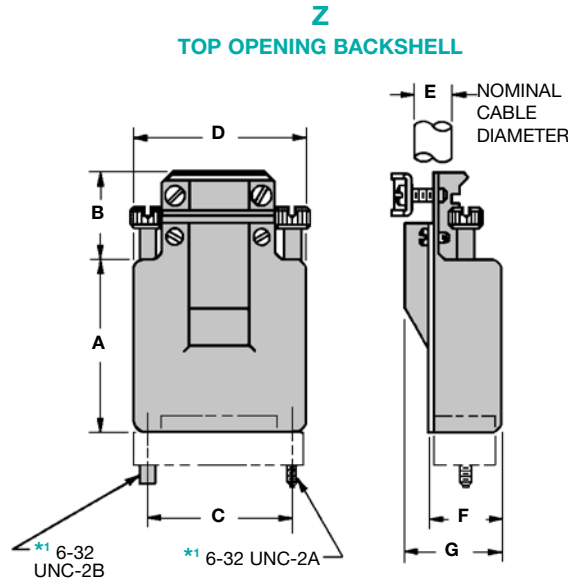

FIGURE 1

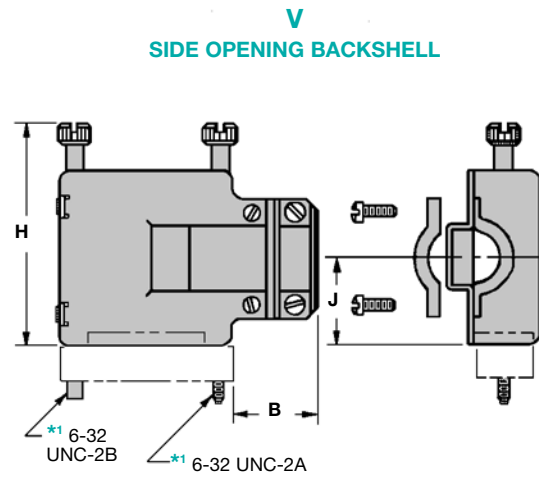

FIGURE 2

PART NUMBER	FIGURE	A	B	C	D	E	F	G	H	J
SG10400000Z0	1	2.100 [53.34]	0.812 [20.62]	1.750 [44.45]	2.100 [53.34]	0.500 [12.70]	0.860 [21.84]	1.110 [28.19]	2.645 [67.18]	-
SG10400000V0	2	2.100 [53.34]	0.812 [20.62]	1.750 [44.45]	2.100 [53.34]	0.500 [12.70]	0.860 [21.84]	1.110 [28.19]	2.645 [67.18]	1.050 [26.67]

NOTE:

*1 M3x0.5 metric threads available, see chart on page 31.

**QUICK DISCONNECT LOCKING DEVICE
CODE V OR VL**

**V
LOCKING TABS**

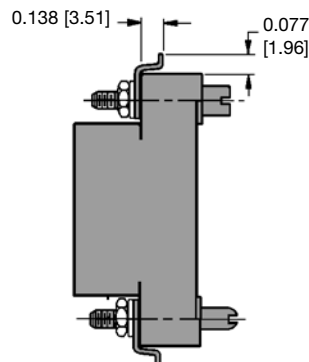

**TYPICAL PART NUMBER:
SGMC14S0N000V**

**VL
ACTUATION LOCK
LEVER ASSEMBLY**

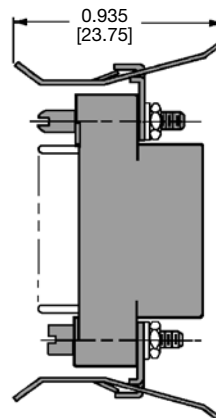

**TYPICAL PART NUMBER:
SGMC14M0N000VL**



APPLICATION TOOLS SECTION

SGMC connectors are offered with **removable crimp contacts**.

Positronic recognizes the **importance of supplying application tooling** to support our customers' use of our products.

Information on application tooling is **available** on our web site at

<https://www.connectpositronic.com/tooling/>

There you will find **downloadable PDF** cross reference charts for removable and compliant press-in contacts. These charts will **supply part numbers** for insertion, removal and crimping tools, along with **information regarding use** of tools and techniques.



APPLICATION TOOLS

Connectors Designed To Customer Specifications

Positronic **SGMC, SGM and SMPL series** connectors can be modified to customer specifications.

Examples: select loading of contacts for cost savings or to gain creepage and clearance distances; longer printed circuit board terminations; customer specified hardware.

Contact Technical Sales with your particular requirements.



CONTACT APPLICATION TOOLS CROSS REFERENCE LIST

USE INDICATED POSITRONIC TOOLS FOR BEST RESULTS

Positronic Contact P/N	Handle & Positioner P/N	Hand Crimp Tool P/N	Mfg. Cross	Mil Equiv	Positioner	Mfg. Cross	Mil Equiv	Insertion Tool	Mfg. Cross	Mil Equiv	Removal Tool	Mfg. Cross	Mil Equiv	Automatic Crimp Tool *† See Note
FC420P2	...	9507-0-0-0	AFM8	M22520/2-01	9502-13-0-0	K280	...	9099-1-0-0	ITH 1056	M81969/18-02	9081-1-0-0	RTCO 2061	...	9550-1-0-0
FC422P2	...	9507-0-0-0	AFM8	M22520/2-01	9502-13-0-0	K280	...	9099-1-0-0	ITH 1056	M81969/18-02	9081-1-0-0	RTCO 2061	...	9550-1-0-0
FC422P2** Thermocouple	...	9507-0-0-0	AFM8	M22520/2-01	9502-13-0-0	K280	...	9099-1-0-0	ITH 1056	M81969/18-02	9081-1-0-0	RTCO 2061	...	9550-1-0-0
FDS425P2	9099-1-0-0	ITH 1056	M81969/18-02	9081-1-0-0	RTCO 2061
FDS456P2	9099-1-0-0	ITH 1056	M81969/18-02	9081-1-0-0	RTCO 2061
FDS487P2	9099-1-0-0	ITH 1056	M81969/18-02	9081-1-0-0	RTCO 2061
FPF467P2	9099-1-0-0	ITH 1056	M81969/18-02	9081-1-0-0	RTCO 2061
FS420P2	9099-1-0-0	ITH 1056	M81969/18-02	9081-1-0-0	RTCO 2061
FS422P2	9099-1-0-0	ITH 1056	M81969/18-02	9081-1-0-0	RTCO 2061
M39029/34-440	...	9507-0-0-0	AFM8	M22520/2-01	9502-12-0-0	K187	...	9099-1-0-0	ITH 1056	M81969/18-02	9081-1-0-0	RTCO 2061
M39029/35-441	...	9507-0-0-0	AFM8	M22520/2-01	9502-13-0-0	K280	...	9099-1-0-0	ITH 1056	M81969/18-02	9081-1-0-0	RTCO 2061
MC420N	...	9507-0-0-0	AFM8	M22520/2-01	9502-12-0-0	K187	...	9099-1-0-0	ITH 1056	M81969/18-02	9081-1-0-0	RTCO 2061	...	9550-1-0-0
MC422N	...	9507-0-0-0	AFM8	M22520/2-01	9502-12-0-0	K187	...	9099-1-0-0	ITH 1056	M81969/18-02	9081-1-0-0	RTCO 2061	...	9550-1-0-0
MC422N** Thermocouple	...	9507-0-0-0	AFM8	M22520/2-01	9502-12-0-0	K187	...	9099-1-0-0	ITH 1056	M81969/18-02	9081-1-0-0	RTCO 2061	...	9550-1-0-0
MDS425N	9099-1-0-0	ITH 1056	M81969/18-02	9081-1-0-0	RTCO 2061
MDS456N	9099-1-0-0	ITH 1056	M81969/18-02	9081-1-0-0	RTCO 2061
MDS487N	9099-1-0-0	ITH 1056	M81969/18-02	9081-1-0-0	RTCO 2061
MDF467N	9099-1-0-0	ITH 1056	M81969/18-02	9081-1-0-0	RTCO 2061
MS420N	9099-1-0-0	ITH 1056	M81969/18-02	9081-1-0-0	RTCO 2061
MS422N	9099-1-0-0	ITH 1056	M81969/18-02	9081-1-0-0	RTCO 2061

STOOL NOTIFICATION

*† All male and female crimp contacts can be ordered on reels in quantities of 2,000 by adding letter "R" after the contact part number, see page 11 for more information.



COMPLIANT PRESS-IN CONNECTOR INSTALLATION TOOLS

USE INDICATED POSITRONIC TOOLS FOR BEST RESULTS

Positronic offers expert assistance in adapting application tooling to your manufacturing environment. Contact our application tooling specialist for assistance.

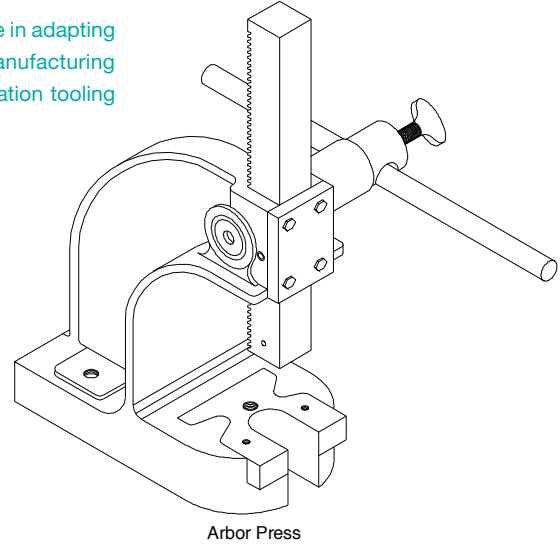
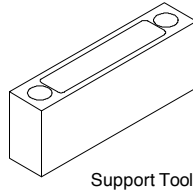
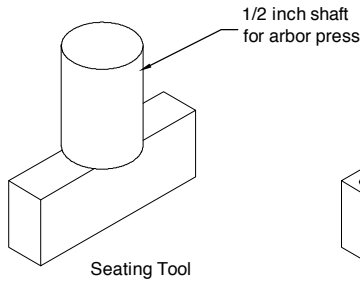

APPLICATION TOOLS

POSITRONIC RECOMMENDED TOOLS FOR COMPLIANT PRESS-IN CONNECTORS AND CONTACTS

CONNECTOR VARIANT (NUMBER OF CONTACTS)	SUPPORT TOOL	CONNECTOR SEATING TOOL WITH ARBOR PRESS SHAFT		CONNECTOR SEATING TOOL WITHOUT ARBOR PRESS SHAFT		ARBOR PRESS FOR SEATING TOOLS
		FEMALE P / N	MALE P / N	FEMALE P / N	MALE P / N	
4	9513-40-4-41	9513-42-4-41	9513-41-4-41	9513-44-4-41	9513-43-4-41	Use p / n 9530-1-0 1 ton capacity 4 inch throat
5	9513-40-5-41	9513-42-5-41	9513-41-5-41	9513-44-5-41	9513-43-5-41	
7	9513-40-7-41	9513-42-7-41	9513-41-7-41	9513-44-7-41	9513-43-7-41	
9	9513-40-9-41	9513-42-9-41	9513-41-9-41	9513-44-9-41	9513-43-9-41	
11	9513-40-11-41	9513-42-11-41	9513-41-11-41	9513-44-11-41	9513-43-11-41	
14	9513-40-14-41	9513-42-14-41	9513-41-14-41	9513-44-14-41	9513-43-14-41	
20	9513-40-20-41	9513-42-20-41	9513-41-20-41	9513-44-20-41	9513-43-20-41	
26	9513-40-26-41	9513-42-26-41	9513-41-26-41	9513-44-26-41	9513-43-26-41	
29	9513-40-29-41	9513-42-29-41	9513-41-29-41	9513-44-29-41	9513-43-29-41	
34	9513-40-34-41	9513-42-34-41	9513-41-34-41	9513-44-34-41	9513-43-34-41	
44	9513-40-44-41	9513-42-44-41	9513-41-44-41	9513-44-44-41	9513-43-44-41	
50	9513-40-50-41	9513-42-50-41	9513-41-50-41	9513-44-50-41	9513-43-50-41	



SUGGESTED PRINTED BOARD HOLE SIZES FOR COMPLIANT PRESS-IN CONNECTORS

Traditionally, tin-lead has been a popular plating for printed circuit boards (PCB) holes. However, many PCB hole platings must now be RoHS Compliant. Positronic is pleased to offer **PCB HOLE SIZE FOR RoHS** PCB plating as shown below.

OMEGA COMPLIANT PRESS-IN CONTACT HOLE				
BOARD TYPE	CONTACT SIZE / TYPE	RECOMMENDED DRILL HOLE SIZE	RECOMMENDED PLATING	FINISHED HOLE SIZES
TIN-LEAD SOLDER PCB	22 OMEGA	$\phi 0.0453 \pm 0.0010$ [$\phi 1.150 \pm 0.025$]	0.0006 [15 μ] minimum solder over 0.0010 [25 μ] min. copper	$\phi 0.0394 + 0.0035 - 0.0024$ [$\phi 1.000 + 0.090 - 0.060$]
RoHS PCB PLATING OPTIONS				
COPPER PCB	22 OMEGA	$\phi 0.047 \pm 0.001$ [$\phi 1.19 \pm 0.025$]	0.0010 [25 μ] min. copper	$\phi 0.043 \pm 0.002$ [$\phi 1.09 \pm 0.05$]
IMMERSION TIN PCB	22 OMEGA	$\phi 0.047 \pm 0.001$ [$\phi 1.19 \pm 0.025$]	0.000033 \pm 0.000006 [0.85 \pm 0.15 μ] immersion tin over 0.0010 [25 μ] min. copper	$\phi 0.043 \pm 0.002$ [$\phi 1.09 \pm 0.05$]
IMMERSION SILVER PCB	22 OMEGA	$\phi 0.047 \pm 0.001$ [$\phi 1.19 \pm 0.025$]	0.000013 \pm 0.000007 [0.34 \pm 0.17 μ] immersion silver over 0.0010 [25 μ] min. copper	$\phi 0.043 \pm 0.002$ [$\phi 1.09 \pm 0.05$]
ELECTROLESS NICKEL / IMMERSION GOLD PCB	22 OMEGA	$\phi 0.047 \pm 0.001$ [$\phi 1.19 \pm 0.025$]	0.000002 [0.05 μ] min. immersion gold over 0.000177 \pm 0.000059 [4.5 \pm 1.5 μ] electroless nickel per IPC-4552 over 0.0010 [25 μ] min. copper	$\phi 0.043 \pm 0.002$ [$\phi 1.09 \pm 0.05$]

“Omega” Termination
utilized on signal contacts

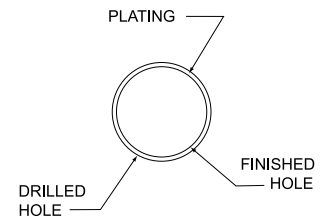
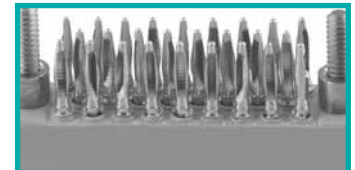

COMPLIANT PRESS-IN TERMINATION CONTACT HOLE

NOTE: For PCB plating compositions not shown, consult Technical Sales.

COMPLIANT PRESS-IN USER INFORMATION

When properly used, Positronic omega compliant press-in terminations provide reliable service even under severe conditions.

Connectors utilizing this leading technology compliant press-in contact are easy to install:

1. Inexpensive installation tooling is available from Positronic, to choose the proper installation tool refer to page 39 for part number ordering information.
2. Insert the connector into the P.C. board or backplane and seat connector fully.
3. Secure the connector to the P.C. board or backplane with supplied hardware.

PCB PRINTED HOLE SIZE



MODIFICATION (MOS) SUFFIXES

Specify complete connector by selecting a base part number from the desired series [Ordering Information Page](#).
Once base part number is selected, add desired modifications (MOS) number below to the end of the part number.

Example part number: SMPL34M0T0LB/AA-14-293.2

(Ordering information pages can be found at the end of each series)

SERIES	CONNECTOR VARIANT	GENDER	TERMINATION TYPE AVAILABLE	MODIFICATION OF STANDARD (MOS) SUFFIXES	DESCRIPTION OF MODIFICATION
SGMC SGM SMPL	ALL	F / M	ALL	-14	Allows connector with contacts installed, for contacts only to be plated 0.000030 [0.76 μ] gold over nickel.
SGMC SGM SMPL	ALL	F / M	ALL	-15	Allows connector with contacts installed, for contacts only to be plated 0.000050 inch [1.27μ] gold over nickel.
SGMC SGM SMPL	ALL	F / M	ALL	-293.2	Allows connector with any polarizing jackscrews to be supplied with jack-screw positions reversed.
SGMC	ALL	F / M	ALL	-650.0	Allows connector with any hardware to be supplied with MC422N or FC422P2 contacts kitted.
SGM	ALL	F / M	DS3, DS4, DS5, DS6	-672.0	Allows connector with straight solder contacts to have standard nylon hex nut and washer replaced with stainless steel hex nut and washer.
SGM	4, 5, 7, 9, 11, 14, 20, 26, 29, 34, 44, and 50	F / M	ALL	-756.2	Allows connector to be supplied with special length "ESS" jackscrews.
SGMC SGM	ALL	F / M	ALL	-793.4	Allows connector to be supplied with special rotating jackscrews with 0.078 [1.98] hex socket head.
SGMC SGM SMPL	ALL	F / M	ALL	/AA	Allows connector for environmental compliance per EU Directive 2002/95/EC (RoHS).

MANY OTHER SPECIAL OPTIONS ARE AVAILABLE CONSULT TECHNICAL SALES
OR VISIT OUR WEB SITE AT WWW.CONNECTPOSITRONIC.COM

Connectors Designed To Customer Specifications

Positronic SGMC, SGM and SMPL series connectors can be modified to customer specifications.

Examples: select loading of contacts for cost savings or to gain creepage and clearance distances; longer printed circuit board terminations; customer specified hardware.

Contact Technical Sales with your particular requirements.

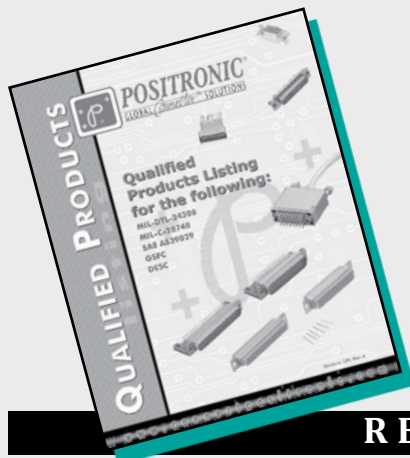

Positronic® offers a variety of QPL connector products

RECTANGULAR CONNECTORS

MIL PREFIX	POSITRONIC SERIES
MIL-DTL-28748/3	GMCT
MIL-DTL-28748/4	GMCT
MIL-DTL-28748/5	GM
MIL-DTL-28748/6	GM
MIL-DTL-28748/7	SGM

MIL PREFIX	POSITRONIC SERIES
MIL-DTL-28748/8	SGM
MIL-C-28748/13	SGMC
MIL-C-28748/14	SGMC
SAE AS39029/34	SGMC, GMCT
SAE AS39029/35	SGMC, GMCT

D - SUBMINIATURE CONNECTORS

MIL PREFIX	POSITRONIC SERIES
MIL-DTL-24308/1	HDC
MIL-DTL-24308/2	RD, DD
MIL-DTL-24308/3	HDC
MIL-DTL-24308/4	RD, DD
MIL-DTL-24308/5	HDC
MIL-DTL-24308/6	RD, DD
MIL-DTL-24308/7	HDC
MIL-DTL-24308/8	RD, DD
MIL-DTL-24308/23	HDC, DD

MIL PREFIX	POSITRONIC SERIES
MIL-DTL-24308/24	HDC, DD
MIL-DTL-24308/25	HDC, RD, DD
MIL-DTL-24308/26	HDC, RD, DD
GSFC S-311-P4	SND, SDD, SCBC, SCBM
GSFC S-311-P10	SND, SCBM
SAE AS39029/57	DD
SAE AS39029/58	DD
SAE AS39029/63	RD
SAE AS39029/64	RD

For a complete QPL listing available to download in PDF format, select 'SUPPORT' on the menu bar and pull to "QPL" on our website at:

www.connectpositronic.com

or enter the URL link below to download the QPL PDF file immediately!

<https://www.connectpositronic.com/qpl/>



Positronic[®]

THE SCIENCE OF CERTAINTY

Regional Headquarters

Positronic | Americas

423 N Campbell Ave
Springfield MO 65806 USA

+1 800 641 4054
info@connectpositronic.com

Positronic | Europe

Z.I. d'Engachies
46, route d'Engachies
F-32020 Auch Cedex 9 France

+33 5 6263 4491
contact@connectpositronic.com

Positronic | Asia

3014A Ubi Rd 1 #07-01
Singapore 408703

+65 6842 1419
singapore@connectpositronic.com

Sales Offices

Positronic has local sales representation all over the world. To find the nearest sales office, please visit www.connectpositronic.com/locations

LOCATIONS

connectpositronic.com

X-ON Electronics

Largest Supplier of Electrical and Electronic Components

Click to view similar products for [Rectangular MIL Spec Connectors](#) category:

Click to view products by [Positronic](#) manufacturer:

Other Similar products are found below :

[M32139/03-B06ST](#) [65002-062](#) [77058-22-55PN](#) [86.030.0053.0](#) [GMCT26M0E100JC](#) [1241346-1](#) [MSO34MPK1E1](#) [BACC65CAMA](#) [HSB-D4S03DM222X](#) [890-009-31SA2-BRT1T](#) [27963-20T12](#) [SIM2N40NC3](#) [SIM2S100A](#) [1604996-2](#) [SMD25PN90L-4055](#) [22628-10-6P-791](#)
[GMCT66F0T0000](#) [M32139/03-G05SN](#) [CTD160E01F-6148](#) [CTJ112E03B](#) [CTJ-3D-12](#) [CTJ920E06N-513](#) [CTL-16-090](#) [CY4600-000](#)
[CY4601-000](#) [38111-14-15SN](#) [TMN2N037PC2DM018S](#) [TMN2N051SC2DM018T](#) [MMA23-0111R1](#) [MMD25-0071P1](#) [33516062020](#)
[33526M11-08PC](#) [33526M11-08PE](#) [3355-5869-000](#) [DMC-M99-01AN](#) [Y59113WE20PNV00300](#) [ZPF000000000106310](#) [105979-31](#)
[MTCPK1PJC02S](#) [SIM2N40NC1](#) [SIM2N40NC2](#) [SIM2S110A](#) [SIME2022PNR](#) [787-0015-02](#) [TMN2N009SC2DM018T](#)
[TMN2N025PC2DM018S](#) [ZPF000000000106308](#) [ZPF000000000102759](#) [CTG-20-08-513](#) [5634-201-03158](#)