

### Chopper IGBTMOD™ U-Series Module 50 Amperes/1200 Volts

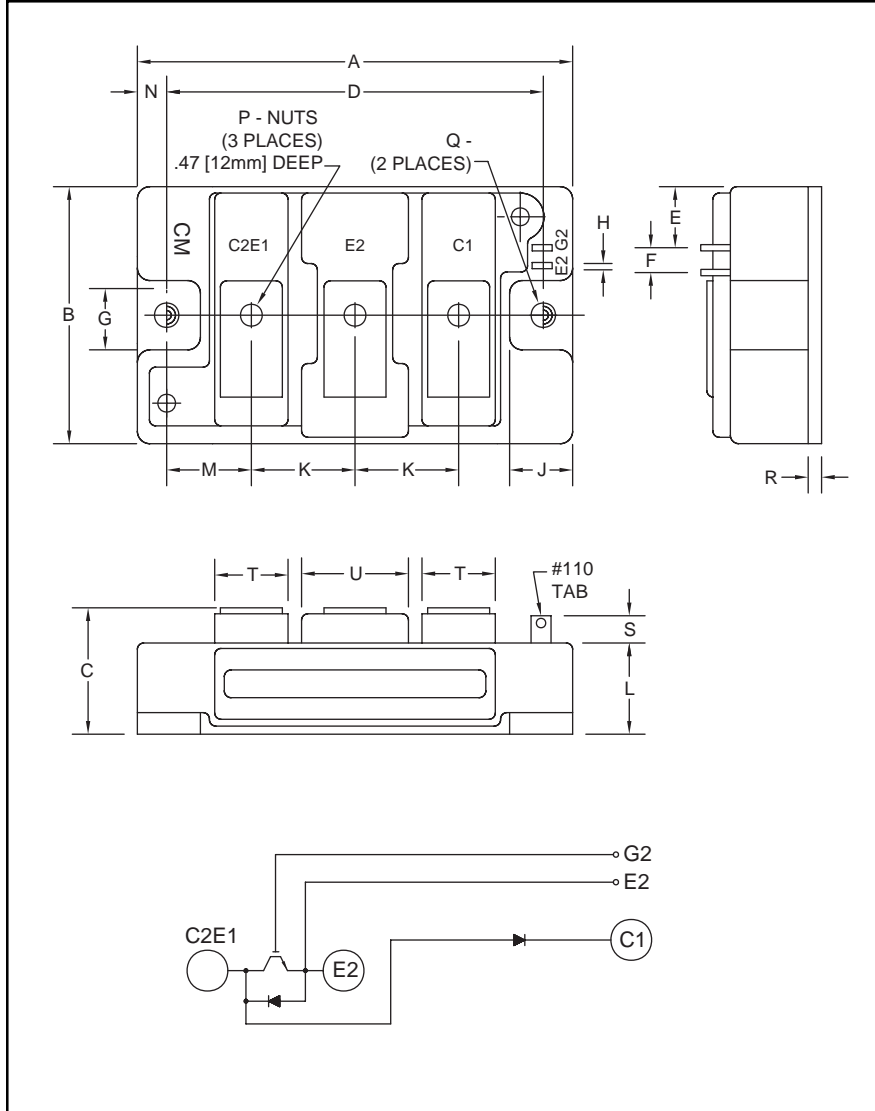

Outline Drawing and Circuit Diagram

Dimensions	Inches	Millimeters
A	3.70	94.0
B	1.89	48.0
C	1.18 +0.04/-0.02	30.0 +1.0/-0.5
D	3.15±0.01	80.0±0.25
E	0.43	11.0
F	0.16	4.0
G	0.51	13.0
H	0.02	0.5
J	0.53	13.5
K	0.91	23.0

Dimensions	Inches	Millimeters
L	0.84	21.2
M	0.67	17.0
N	0.28	7.0
P	M5	M5
Q	0.26 Dia.	6.5 Dia.
R	0.02	4.0
S	0.30	7.5
T	0.63	16.0
U	0.98	25.0



#### Description:

Powerex Chopper IGBTMOD™ Modules are designed for use in switching applications. Each module consists of one IGBT Transistor having a reverse-connected super-fast recovery free-wheel diode and an anode-collector connected super-fast recovery free-wheel diode. All components and interconnects are isolated from the heat sinking baseplate, offering simplified system assembly and thermal management.

#### Features:

- Low Drive Power
- Low  $V_{CE(sat)}$
- Discrete Super-Fast Recovery Free-Wheel Diode
- High Frequency Operation (15-20kHz)
- Isolated Baseplate for Easy Heat Sinking

#### Applications:

- DC Motor Control
- Boost Regulator

#### Ordering Information:

Example: Select the complete module number you desire from the table - i.e. CM50E3U-24H is a 1200V ( $V_{CES}$ ), 50 Ampere Chopper IGBTMOD™ Power Module.

Type	Current Rating Amperes	$V_{CES}$ Volts (x 50)
CM	50	24

## CM50E3U-24H

### Chopper IGBTMOD™ U-Series Module

50 Amperes/1200 Volts

#### Absolute Maximum Ratings, $T_j = 25\text{ }^\circ\text{C}$ unless otherwise specified

Ratings	Symbol	CM50E3U-24H	Units
Junction Temperature	$T_j$	-40 to 150	$^\circ\text{C}$
Storage Temperature	$T_{stg}$	-40 to 125	$^\circ\text{C}$
Collector-Emitter Voltage (G-E SHORT)	$V_{CES}$	1200	Volts
Gate-Emitter Voltage (C-E SHORT)	$V_{GES}$	$\pm 20$	Volts
Collector Current ( $T_c = 25^\circ\text{C}$ )	$I_C$	50	Amperes
Peak Collector Current	$I_{CM}$	100*	Amperes
Emitter Current** ( $T_c = 25^\circ\text{C}$ )	$I_E$	50	Amperes
Peak Emitter Current**	$I_{EM}$	100*	Amperes
Maximum Collector Dissipation ( $T_c = 25^\circ\text{C}$ , $T_j \leq 150^\circ\text{C}$ )	$P_C$	400	Watts
Mounting Torque, M5 Main Terminal	–	31	in-lb
Mounting Torque, M6 Mounting	–	40	in-lb
Weight	–	310	Grams
Isolation Voltage (Main Terminal to Baseplate, AC 1 min.)	$V_{iso}$	2500	Volts

\* Pulse width and repetition rate should be such that the device junction temperature ( $T_j$ ) does not exceed  $T_{j(max)}$  rating.

\*\*Represents characteristics of the anti-parallel, emitter-to-collector free-wheel diode (FWDi).

#### Static Electrical Characteristics, $T_j = 25\text{ }^\circ\text{C}$ unless otherwise specified

Characteristics	Symbol	Test Conditions	Min.	Typ.	Max.	Units
Collector-Cutoff Current	$I_{CES}$	$V_{CE} = V_{CES}$ , $V_{GE} = 0V$	–	–	1	mA
Gate Leakage Voltage	$I_{GES}$	$V_{GE} = V_{GES}$ , $V_{CE} = 0V$	–	–	0.5	$\mu\text{A}$
Gate-Emitter Threshold Voltage	$V_{GE(th)}$	$I_C = 5\text{mA}$ , $V_{CE} = 10V$	4.5	6	7.5	Volts
Collector-Emitter Saturation Voltage	$V_{CE(sat)}$	$I_C = 50\text{A}$ , $V_{GE} = 15V$ , $T_j = 25^\circ\text{C}$	–	2.9	3.7	Volts
		$I_C = 50\text{A}$ , $V_{GE} = 15V$ , $T_j = 125^\circ\text{C}$	–	2.85	–	Volts
Total Gate Charge	$Q_G$	$V_{CC} = 600V$ , $I_C = 50\text{A}$ , $V_{GE} = 15V$	–	187	–	nC
Emitter-Collector Voltage**	$V_{EC}$	$I_E = 50\text{A}$ , $V_{GE} = 0V$	–	–	3.2	Volts
Emitter-Collector Voltage	$V_{FM}$	$I_F = 50\text{A}$ , Clamp Diode Part	–	–	3.2	Volts

\*\*Represents characteristics of the anti-parallel, emitter-to-collector free-wheel diode (FWDi).

#### Dynamic Electrical Characteristics, $T_j = 25\text{ }^\circ\text{C}$ unless otherwise specified

Characteristics	Symbol	Test Conditions	Min.	Typ.	Max.	Units	
Input Capacitance	$C_{ies}$		–	–	7.5	nf	
Output Capacitance	$C_{oes}$	$V_{CE} = 10V$ , $V_{GE} = 0V$	–	–	2.6	nf	
Reverse Transfer Capacitance	$C_{res}$		–	–	1.5	nf	
Resistive	Turn-on Delay Time	$t_{d(on)}$	$V_{CC} = 600V$ , $I_C = 50\text{A}$ ,	–	–	80	
							Load
Switch	Turn-off Delay Time	$t_{d(off)}$	$R_G = 6.3\Omega$ , Resistive	–	–	150	
							Times
Diode Reverse Recovery Time**	$t_{rr}$	$I_E = 50\text{A}$ , $di_E/dt = -100\text{A}/\mu\text{s}$	–	–	300	ns	
Diode Reverse Recovery Charge**	$Q_{rr}$	$I_E = 50\text{A}$ , $di_E/dt = -100\text{A}/\mu\text{s}$	–	0.28	–	$\mu\text{C}$	
Diode Reverse Recovery Time	$t_{rr}$	$I_F = 50\text{A}$ , Clamp Diode Part,	–	–	300	ns	
Diode Reverse Recovery Charge	$Q_{rr}$	$di_F/dt = -100\text{A}/\mu\text{s}$	–	0.28	–	$\mu\text{C}$	

\*\*Represents characteristics of the anti-parallel, emitter-to-collector free-wheel diode (FWDi).

**CM50E3U-24H**  
**Chopper IGBTMOD™ U-Series Module**  
 50 Amperes/1200 Volts

**Thermal and Mechanical Characteristics,  $T_j = 25^\circ\text{C}$  unless otherwise specified**

Characteristics	Symbol	Test Conditions	Min.	Typ.	Max.	Units
Thermal Resistance, Junction to Case	$R_{th(j-c)Q}$	Per IGBT	–	–	0.31	$^\circ\text{C/W}$
Thermal Resistance, Junction to Case	$R_{th(j-c)D}$	Per FWDi	–	–	0.7	$^\circ\text{C/W}$
Thermal Resistance, Junction to Case	$R_{th(j-c)}$	Clamp Diode Part	–	–	0.7	$^\circ\text{C/W}$
Contact Thermal Resistance	$R_{th(c-f)}$	Per Module, Thermal Grease Applied	–	0.035	–	$^\circ\text{C/W}$

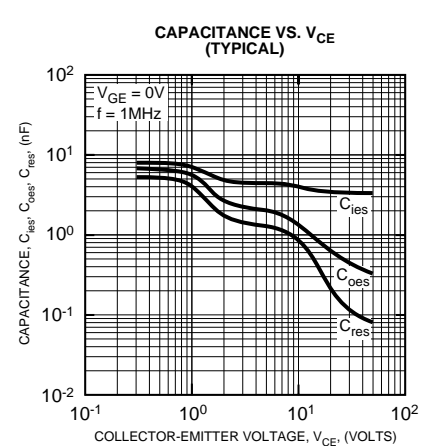
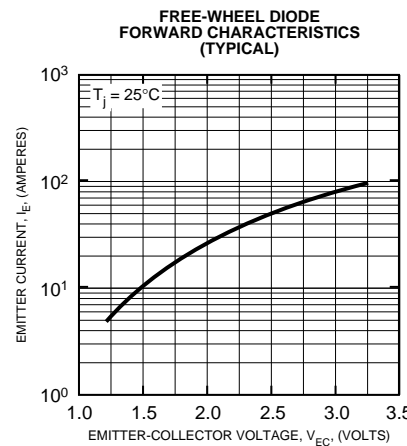
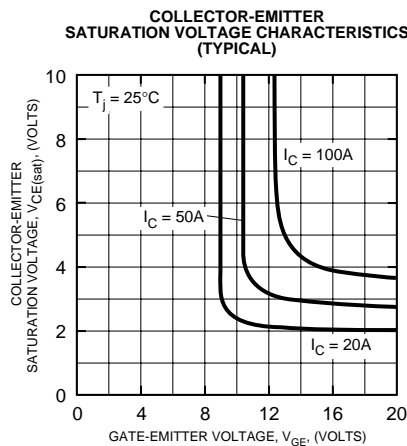
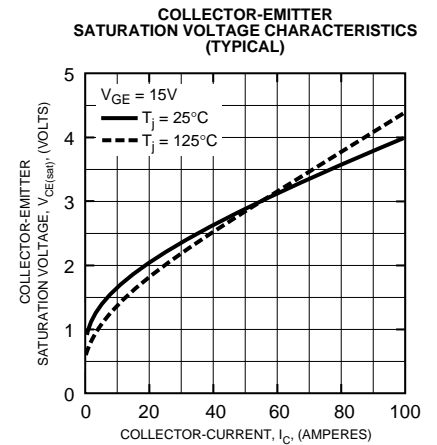
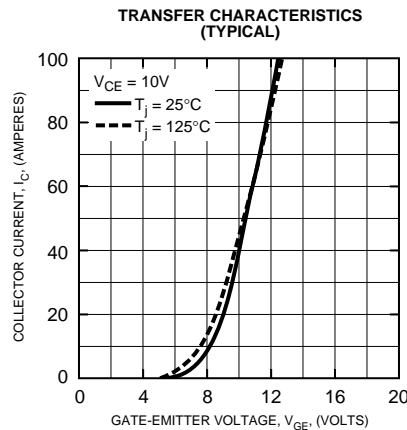
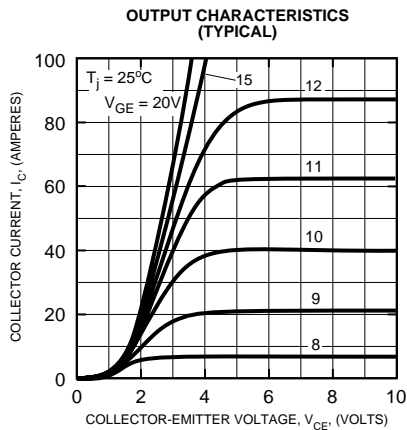

**CM50E3U-24H**  
**Chopper IGBTMOD™ U-Series Module**  
 50 Amperes/1200 Volts

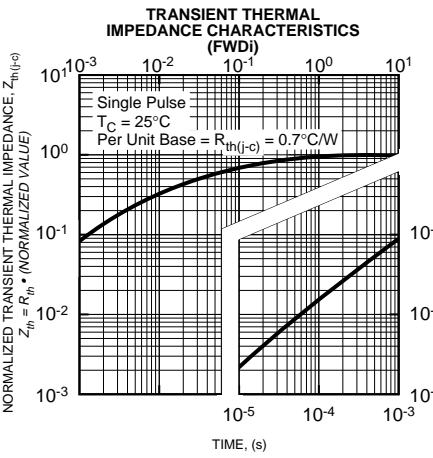
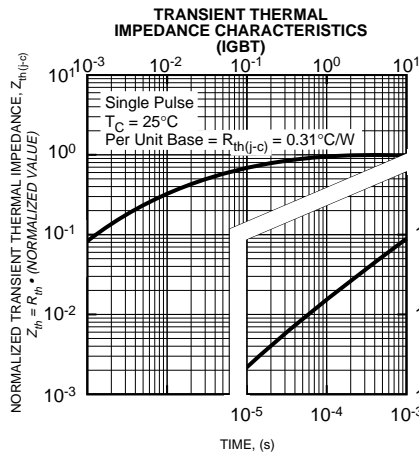
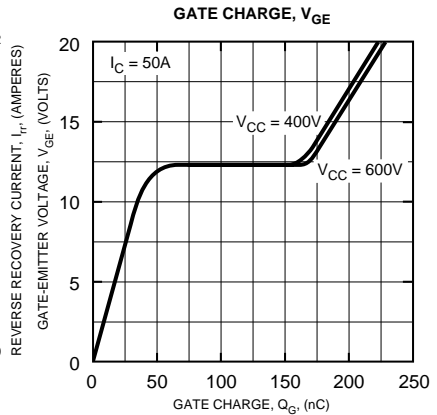
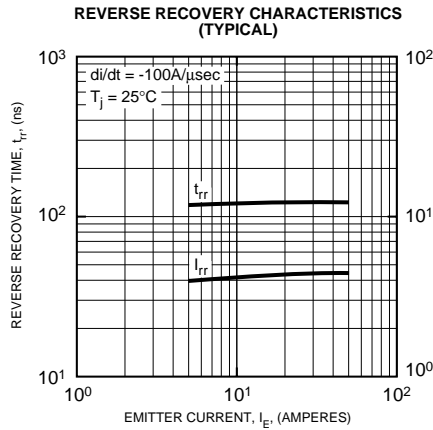
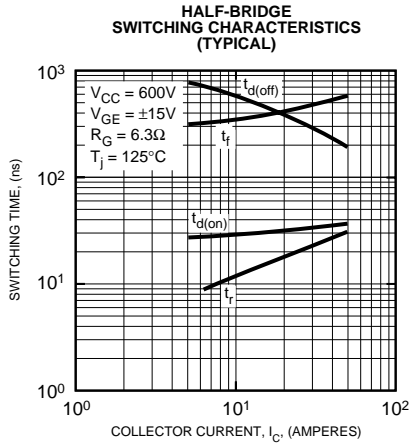

## X-ON Electronics

Largest Supplier of Electrical and Electronic Components

*Click to view similar products for [IGBT Modules category](#):*

*Click to view products by [Powerex manufacturer](#):*

Other Similar products are found below :

[F3L100R07W2E3\\_B11](#) [F3L15R12W2H3\\_B27](#) [F3L400R07ME4\\_B22](#) [F3L400R12PT4\\_B26](#) [F4-100R12KS4](#) [F4-50R07W2H3\\_B51](#) [F4-75R12KS4\\_B11](#) [FB15R06W1E3](#) [FB20R06W1E3\\_B11](#) [FD1000R33HE3-K](#) [FD200R12KE3](#) [FD300R06KE3](#) [FD300R12KE3](#) [FD300R12KS4\\_B5](#) [FD400R12KE3](#) [FD400R33KF2C-K](#) [FD401R17KF6C\\_B2](#) [FD-DF80R12W1H3\\_B52](#) [FF100R12KS4](#) [FF1200R17KE3\\_B2](#) [FF150R12KE3G](#) [FF200R06KE3](#) [FF200R06YE3](#) [FF200R12KT3](#) [FF200R12KT3\\_E](#) [FF200R12KT4](#) [FF200R17KE3](#) [FF300R06KE3\\_B2](#) [FF300R12KE4\\_E](#) [FF300R12KS4HOSA1](#) [FF300R12ME4\\_B11](#) [FF300R12MS4](#) [FF300R17ME4](#) [FF450R12ME4P](#) [FF450R17IE4](#) [FF600R12IE4V](#) [FF600R12IP4V](#) [FF800R17KE3](#) [FF800R17KP4\\_B2](#) [FF900R12IE4V](#) [MIXA30W1200TED](#) [MIXA450PF1200TSF](#) [FP06R12W1T4\\_B3](#) [FP100R07N3E4](#) [FP100R07N3E4\\_B11](#) [FP10R06W1E3\\_B11](#) [FP10R12W1T4\\_B11](#) [FP10R12YT3](#) [FP10R12YT3\\_B4](#) [FP150R07N3E4](#)