

# LXA16T600C

## Qspeed™ Family



600 V, 16 A X-Series Common-Cathode Diode

### Product Summary

|                                    |      |    |
|------------------------------------|------|----|
| $I_{F(AVG)}$ per diode             | 8    | A  |
| $V_{RRM}$                          | 600  | V  |
| $Q_{RR}$ (Typ at 125 °C)           | 82   | nC |
| $I_{RRM}$ (Typ at 125 °C)          | 3.5  | A  |
| Softness $t_b/t_a$ (Typ at 125 °C) | 0.55 |    |

### Pin Assignment

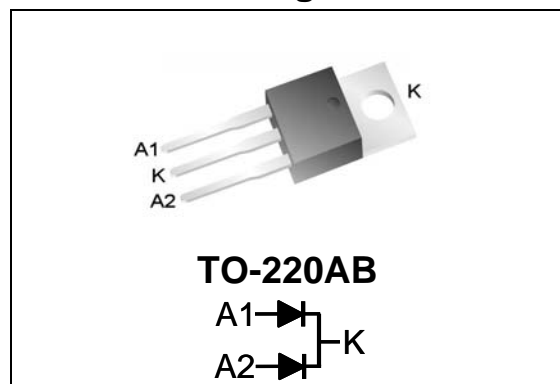

### RoHS Compliant

Package uses Lead-free plating and Green mold compound.  
Halogen free per IEC 61249-2-21.

### General Description

This device has the lowest  $Q_{RR}$  of any 600V Silicon diode. Its recovery characteristics increase efficiency, reduce EMI and eliminate snubbers.

### Applications

- Power Factor Correction (PFC) Boost Diode
- Motor drive circuits
- DC-AC inverters

### Features

- Low  $Q_{RR}$ , Low  $I_{RRM}$ , Low  $t_{RR}$
- High  $di_F/dt$  capable (1000A/ $\mu$ s)
- Soft recovery

### Benefits

- Increases efficiency
  - Eliminates need for snubber circuits
  - Reduces EMI filter component size & count
- Enables extremely fast switching

### Absolute Maximum Ratings

Absolute maximum ratings are the values beyond which the device may be damaged or have its useful life impaired. Functional operation under these conditions is not implied.

| Symbol       | Parameter                         | Conditions  | Rating     | Units |
|--------------|-----------------------------------|---|------------|-------|
| $V_{RRM}$    | Peak repetitive reverse voltage   |   | 600        | V     |
| $I_{F(AVG)}$ | Average forward current           | Per Diode, $T_J = 150\text{ °C}$ , $T_C = 122\text{ °C}$  | 8          | A     |
|              |                                   | Per Device, $T_J = 150\text{ °C}$ , $T_C = 122\text{ °C}$ | 16         | A     |
| $I_{FSM}$    | Non-repetitive peak surge current | 60 Hz, ½ cycle  | 60         | A     |
| $I_{FSM}$    | Non-repetitive peak surge current | ½ cycle of $t = 28\ \mu$ s Sinusoid, $T_C = 25\text{ °C}$ | 350        | A     |
| $T_J$        | Maximum junction temperature      |   | 150        | °C    |
| $T_{STG}$    | Storage temperature               |   | -55 to 150 | °C    |
|              | Lead soldering temperature        | Leads at 1.6mm from case, 10 sec                          | 300        | °C    |
| $P_D$        | Power dissipation                 | $T_C = 25\text{ °C}$                                      | 83         | W     |

### Thermal Resistance

| Symbol          | Resistance from:    | Conditions | Rating | Units |
|-----------------|---------------------|------------|--------|-------|
| $R_{\theta JA}$ | Junction to ambient | TO-220AB   | 62     | °C/W  |
| $R_{\theta JC}$ | Junction to case    | Per Diode  | 1.5    | °C/W  |
|                 |                     | Per Device | 0.8    | °C/W  |

## Electrical Specifications at $T_J = 25\text{ }^\circ\text{C}$ (unless otherwise specified)

| Symbol                                   | Parameter                                   | Conditions  | Min                               | Typ  | Max  | Units         |             |
|--|---|---|-----------------------------------|------|------|---------------|-------------|
| <b>DC Characteristics per diode</b>      |   |   |                                   |      |      |               |             |
| $I_R$                                    | Reverse current per diode                   | $V_R = 600\text{ V}, T_J = 25\text{ }^\circ\text{C}$                  | -                                 | -    | 250  | $\mu\text{A}$ |             |
|  |   | $V_R = 600\text{ V}, T_J = 125\text{ }^\circ\text{C}$                 | -                                 | 0.85 | -    | $\text{mA}$   |             |
| $V_F$                                    | Forward voltage per diode                   | $I_F = 8\text{ A}, T_J = 25\text{ }^\circ\text{C}$                    | -                                 | 2.35 | 2.94 | $\text{V}$    |             |
|  |   | $I_F = 8\text{ A}, T_J = 150\text{ }^\circ\text{C}$                   | -                                 | 2.1  | -    | $\text{V}$    |             |
| $C_J$                                    | Junction capacitance per diode              | $V_R = 10\text{ V}, 1\text{ MHz}$                                     | -                                 | 40   | -    | $\text{pF}$   |             |
| <b>Dynamic Characteristics per diode</b> |   |   |                                   |      |      |               |             |
| $t_{RR}$                                 | Reverse recovery time, per diode            | $di_F/dt = 200\text{ A}/\mu\text{s}$<br>$V_R = 400, I_F = 8\text{ A}$ | $T_J = 25\text{ }^\circ\text{C}$  | -    | 21.5 | -             | $\text{ns}$ |
|  |   |   | $T_J = 125\text{ }^\circ\text{C}$ | -    | 33   | -             | $\text{ns}$ |
| $Q_{RR}$                                 | Reverse recovery charge, per diode          | $di_F/dt = 200\text{ A}/\mu\text{s}$<br>$V_R = 400, I_F = 8\text{ A}$ | $T_J = 25\text{ }^\circ\text{C}$  | -    | 31   | 48            | $\text{nC}$ |
|  |   |   | $T_J = 125\text{ }^\circ\text{C}$ | -    | 82   | -             | $\text{nC}$ |
| $I_{RRM}$                                | Maximum reverse recovery current, per diode | $di_F/dt = 200\text{ A}/\mu\text{s}$<br>$V_R = 400, I_F = 8\text{ A}$ | $T_J = 25\text{ }^\circ\text{C}$  | -    | 2.2  | 2.8           | $\text{A}$  |
|  |   |   | $T_J = 125\text{ }^\circ\text{C}$ | -    | 3.5  | -             | $\text{A}$  |
| S  | Softness per diode = $\frac{t_b}{t_a}$      | $di_F/dt = 200\text{ A}/\mu\text{s}$<br>$V_R = 400, I_F = 8\text{ A}$ | $T_J = 25\text{ }^\circ\text{C}$  | -    | 0.74 | -             |             |
|  |   |   | $T_J = 125\text{ }^\circ\text{C}$ | -    | 0.55 | -             |             |

**Note to component engineers:** X-Series diodes employ Schottky technologies in their design and construction. Therefore, component engineers should plan their test setups to be similar to traditional Schottky test setups. (For further details, see application note AN-300.)

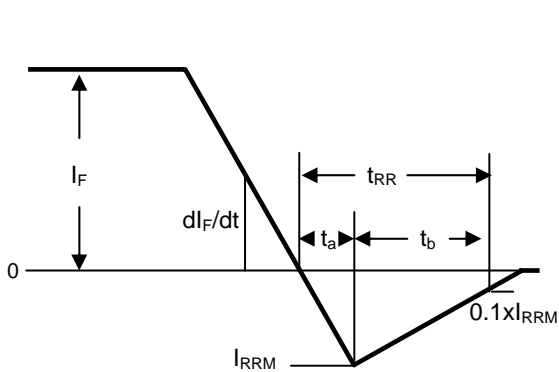

Figure 1. Reverse Recovery Definitions

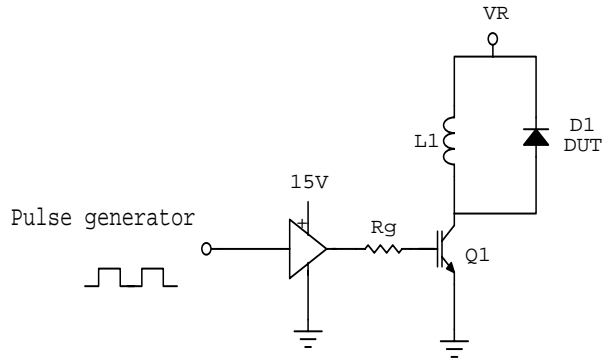
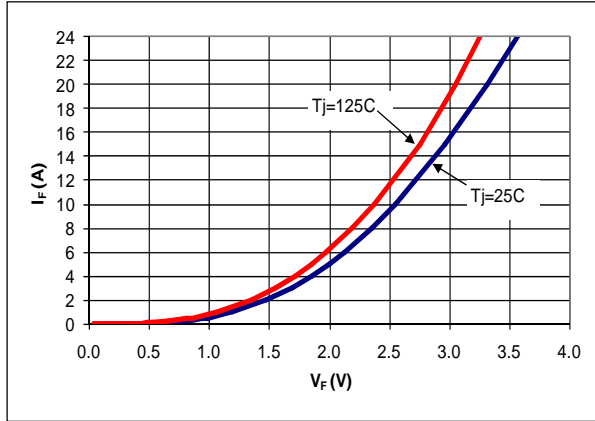
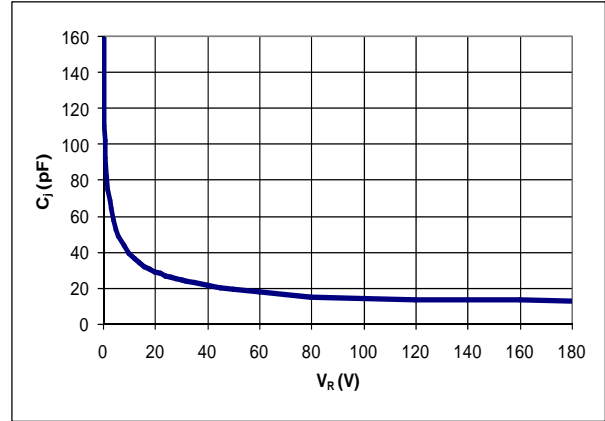

Figure 2. Reverse Recovery Test Circuit

**Electrical Specifications at  $T_J = 25\text{ }^\circ\text{C}$  (unless otherwise specified)**



**Figure 3. Typical  $I_F$  vs  $V_F$**



**Figure 4. Typical  $C_i$  vs  $V_R$**

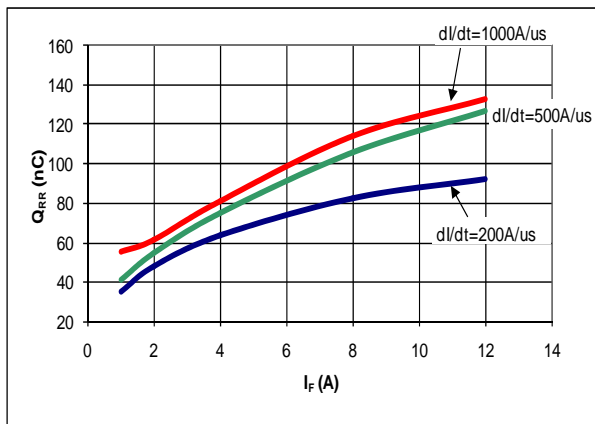

**Figure 5. Typical  $Q_{RR}$  vs  $I_F$  at  $T_J = 125\text{ }^\circ\text{C}$**

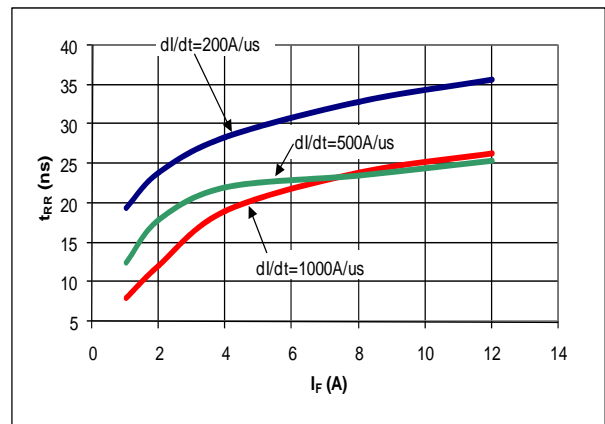

**Figure 6. Typical  $t_{RR}$  vs  $I_F$  at  $T_J = 125\text{ }^\circ\text{C}$**

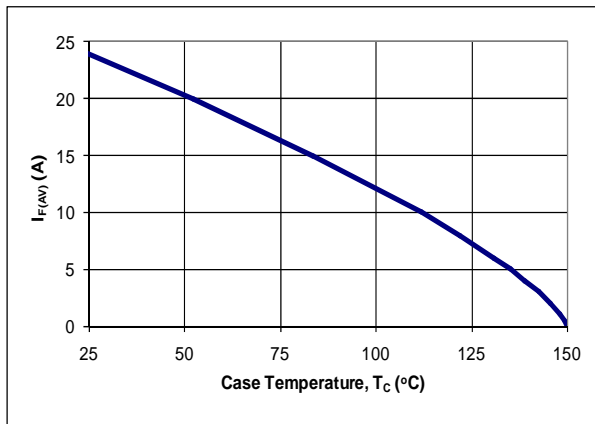

**Figure 7. DC Current Derating Curve**

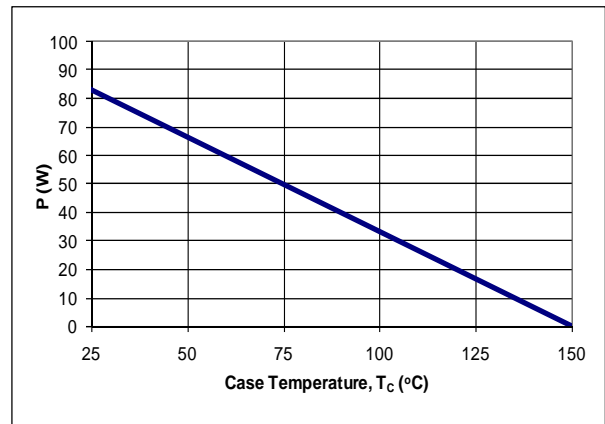

**Figure 8. Power Derating Curve**

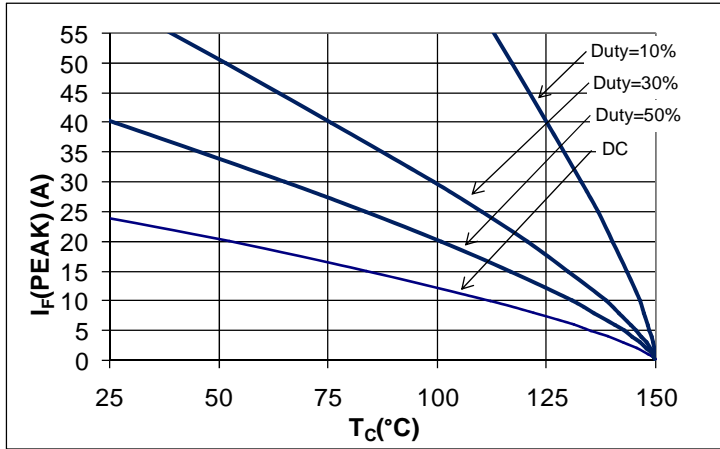

Figure 9.  $I_f(\text{Peak})$  vs  $T_c$ ,  $f=70$  kHz

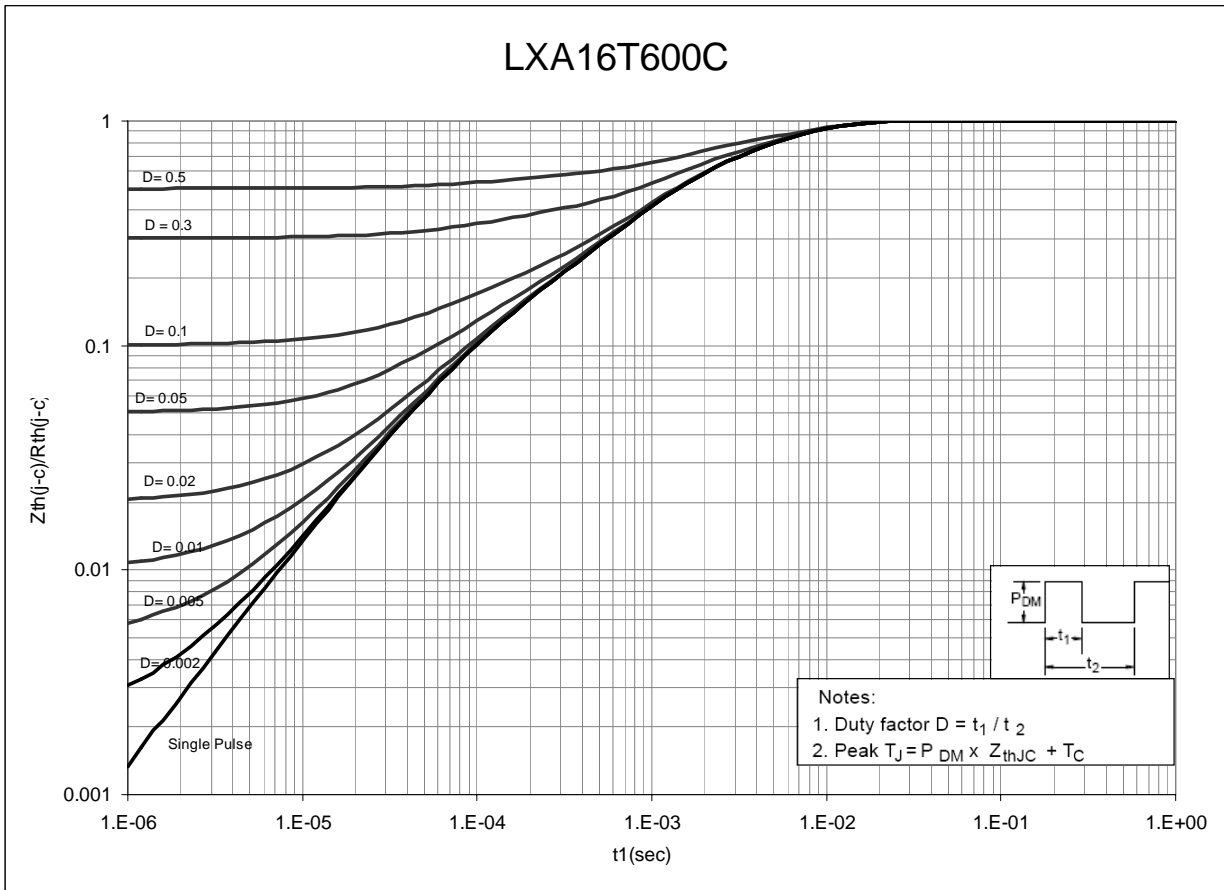
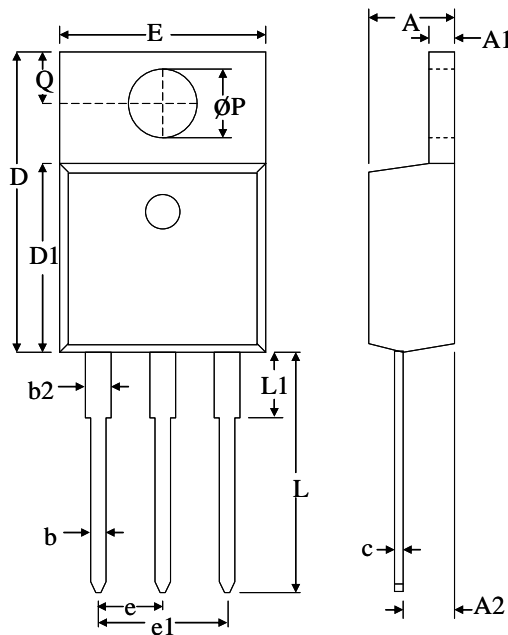

Figure 10. Normalized Maximum Transient Thermal Impedance

**Dimensional Outline Drawings**

TO-220AB



| Dim | Millimeters |       |
|-----|-------------|-------|
|     | MIN         | MAX   |
| A   | 4.32        | 4.70  |
| A1  | 1.11        | 1.38  |
| A2  | 2.59        | 2.79  |
| b   | 0.77        | 1.00  |
| b2  | 1.23        | 1.36  |
| C   | 0.34        | 0.47  |
| D   | 14.71       | 15.75 |
| D1  | 9.05        | 9.25  |
| E   | 9.96        | 10.36 |
| e   | 2.44        | 2.64  |
| e1  | 4.98        | 5.18  |
| L   | 12.70       | 14.22 |
| L1  | –           | 3.90  |
| ØP  | 3.71        | 3.96  |
| Q   | 2.54        | 2.90  |

| Mechanical Mounting Method        | Maximum Torque / Pressure specification   |
|-----------------------------------|---|
| Screw through hole in package tab | 1 Newton Meter (nm) or 8.8 inch-pounds (lb-in)  |
| Clamp against package body        | 12.3 kilogram-force per square centimeter (kgf/cm <sup>2</sup> ) or 175 lbf/in <sup>2</sup> |

**Soldering time and temperature:** This product has been designed for use with high-temperature, lead-free solder. The component leads can be subjected to a maximum temperature of 300 °C, for up to 10 seconds. See Application Note AN-303, for more details.

**Ordering Information**

| Part Number | Package  | Packing       |
|-------------|----------|---------------|
| LXA16T600C  | TO-220AB | 50 units/tube |

The information contained in this document is subject to change without notice.

# LXA16T600C

---

| Revision | Notes                                    | Date  |
|----------|--|-------|
| 1.0      | Released by Qspeed                       | 06/10 |
| 1.1      | Converted to Power Integrations Document | 01/11 |

**For the latest updates, visit our website: [www.powerint.com](http://www.powerint.com)**

Power Integrations reserves the right to make changes to its products at any time to improve reliability or manufacturability. Power Integrations does not assume any liability arising from the use of any device or circuit described herein. POWER INTEGRATIONS MAKES NO WARRANTY HEREIN AND SPECIFICALLY DISCLAIMS ALL WARRANTIES INCLUDING, WITHOUT LIMITATION, THE IMPLIED WARRANTIES OF MERCHANTABILITY, FITNESS FOR A PARTICULAR PURPOSE, AND NON-INFRINGEMENT OF THIRD PARTY RIGHTS.

#### **PATENT INFORMATION**

The products and applications illustrated herein (including transformer construction and circuits external to the products) may be covered by one or more U.S. and foreign patents, or potentially by pending U.S. and foreign patent applications assigned to Power Integrations. A complete list of Power Integrations' patents may be found at [www.powerint.com](http://www.powerint.com). Power Integrations grants its customers a license under certain patent rights as set forth at <http://www.powerint.com/ip.htm>.

The PI Logo, TOPSwitch, TinySwitch, LinkSwitch, DPA-Switch, PeakSwitch, CAPZero, SENZero, LinkZero, HiperPFS, HiperTFS, Qspeed, EcoSmart, Clampless, E-Shield, Filterfuse, StackFET, PI Expert and PI FACTS are trademarks of Power Integrations, Inc. Other trademarks are property of their respective companies. ©Copyright 2011 Power Integrations, Inc.

### **Power Integrations Worldwide Sales Support Locations**

#### **WORLD HEADQUARTERS**

5245 Hellyer Avenue  
San Jose, CA 95138, USA.  
Main: +1-408-414-9200  
Customer Service:  
Phone: +1-408-414-9665  
Fax: +1-408-414-9765  
*e-mail:*  
[usasales@powerint.com](mailto:usasales@powerint.com)

#### **GERMANY**

Rueckertstrasse 3  
D-80336, Munich  
Germany  
Phone: +49-89-5527-3911  
Fax: +49-89-5527-3920  
*e-mail:*  
[eurosales@powerint.com](mailto:eurosales@powerint.com)

#### **JAPAN**

Kosei Dai-3 Building  
2-12-11, Shin-Yokohama,  
Kohoku-ku, Yokohama-shi,  
Kanagawa 222-0033  
Japan  
Phone: +81-45-471-1021  
Fax: +81-45-471-3717  
*e-mail:* [japansales@powerint.com](mailto:japansales@powerint.com)

#### **TAIWAN**

5F, No. 318, Nei Hu Rd., Sec. 1  
Nei Hu District  
Taipei 114, Taiwan R.O.C.  
Phone: +886-2-2659-4570  
Fax: +886-2-2659-4550  
*e-mail:*  
[taiwansales@powerint.com](mailto:taiwansales@powerint.com)

#### **CHINA (SHANGHAI)**

Rm 1601/1610, Tower 1  
Kerry Everbright City  
No. 218 Tianmu Road West  
Shanghai, P.R.C. 200070  
Phone: +86-021-6354-6323  
Fax: +86-021-6354-6325  
*e-mail:*  
[chinasales@powerint.com](mailto:chinasales@powerint.com)

#### **INDIA**

#1, 14<sup>th</sup> Main Road  
Vasanthanagar  
Bangalore-560052  
India  
Phone: +91-80-4113-8020  
Fax: +91-80-4113-8023  
*e-mail:*  
[indiasales@powerint.com](mailto:indiasales@powerint.com)

#### **KOREA**

RM 602, 6FL  
Korea City Air Terminal B/D, 159-6  
Samsung-Dong, Kangnam-Gu,  
Seoul, 135-728  
Korea  
Phone: +82-2-2016-6610  
Fax: +82-2-2016-6630  
*e-mail:* [koreasales@powerint.com](mailto:koreasales@powerint.com)

#### **EUROPE HQ**

1st Floor, St. James's House  
East Street, Farnham  
Surrey GU9 7TJ  
United Kingdom  
Phone: +44 (0) 1252-730-141  
Fax: +44 (0) 1252-727-689  
*e-mail:*  
[eurosales@powerint.com](mailto:eurosales@powerint.com)

#### **CHINA (SHENZHEN)**

Rm A, B & C 4<sup>th</sup> Floor, Block C,  
Electronics Science and  
Technology Building  
2070 Shennan Zhong Road  
Shenzhen, Guangdong,  
P.R.C. 518031  
Phone: +86-755-8379-3243  
Fax: +86-755-8379-5828  
*e-mail:*  
[chinasales@powerint.com](mailto:chinasales@powerint.com)

#### **ITALY**

Via De Amicis 2  
20091 Bresso MI  
Italy  
Phone: +39-028-928-6000  
Fax: +39-028-928-6009  
*e-mail:*  
[eurosales@powerint.com](mailto:eurosales@powerint.com)

#### **SINGAPORE**

51 Newton Road,  
#19-01/05 Goldhill Plaza  
Singapore, 308900  
Phone: +65-6358-2160  
Fax: +65-6358-2015  
*e-mail:*  
[singaporesales@powerint.com](mailto:singaporesales@powerint.com)

#### **APPLICATIONS HOTLINE**

World Wide +1-408-414-9660

#### **APPLICATIONS FAX**

World Wide +1-408-414-9760

## X-ON Electronics

Largest Supplier of Electrical and Electronic Components

*Click to view similar products for [Rectifiers](#) category:*

*Click to view products by [Power Integrations](#) manufacturer:*

Other Similar products are found below :

[70HFR40](#) [RL252-TP](#) [150KR30A](#) [1N5397](#) [NTE5841](#) [NTE6038](#) [SCF5000](#) [1N4002G](#) [1N4005-TR](#) [JANS1N6640US](#) [481235F](#)  
[RRE02VS6SGTR](#) [067907F](#) [MS306](#) [70HF40](#) [T85HFL60S02](#) [US2JFL-TP](#) [A1N5404G-G](#) [CRS04\(T5L,TEMQ\)](#) [ACGRA4007-HF](#)  
[ACGRB207-HF](#) [CLH03\(TE16L,Q\)](#) [ACGRC307-HF](#) [ACEFC304-HF](#) [NTE6356](#) [NTE6359](#) [NTE6002](#) [NTE6023](#) [NTE6039](#) [NTE6077](#)  
[85HFR60](#) [40HFR60](#) [70HF120](#) [85HFR80](#) [D126A45C](#) [SCF7500](#) [D251N08B](#) [SCHJ22.5K](#) [SM100](#) [SCPA2](#) [SCH10000](#) [SDHD5K](#) [VS-](#)  
[12FL100S10](#) [ACGRA4001-HF](#) [D1821SH45T PR](#) [D1251S45T](#) [NTE5990](#) [NTE6358](#) [NTE6162](#) [NTE5850](#)