



<b>Title</b>	<b><i>Reference Design Report for a 35 W Power Supply Using TOPSwitch™-HX TOP258PN</i></b>
<b>Specification</b>	90 VAC to 265 VAC Input; 5 V, 2.2 A and 12 V, 2 A Outputs
<b>Application</b>	LCD Monitor
<b>Author</b>	Applications Engineering Department
<b>Document Number</b>	RDR-142
<b>Date</b>	August 07, 2014
<b>Revision</b>	1.3

#### **Summary and Features**

- Low cost, low component count, high efficiency
  - Delivers 35 W at 50 °C ambient without requiring an external heat sink
  - Meets output cross regulation requirements without linear regulators
- EcoSmart™ – meets requirements for low no-load and standby power consumption
  - 0.42 W output power for <1 W input
  - No-load power consumption < 300 mW at 230 VAC
  - >82% full load efficiency
- Integrated safety/reliability features
  - Accurate, auto-recovering, hysteretic thermal shutdown function maintains safe PCB temperatures under all conditions
  - Auto-restart protects against output short-circuits and open feedback loops
  - Output OVP protection configurable for latching or self-recovering
  - Input UV prevents power up / power down output glitches
- Meets EN55022 and CISPR-22 Class B conducted EMI with >10 dB $\mu$ V margin

The products and applications illustrated herein (including circuits external to the products and transformer construction) may be covered by one or more U.S. and foreign patents or potentially by pending U.S. and foreign patent applications assigned to Power Integrations. A complete list of Power Integrations' patents may be found at [www.powerint.com](http://www.powerint.com).

## Table of Contents

1	Introduction.....	4
2	Power Supply Specification .....	5
3	Schematic.....	6
4	Circuit Description .....	7
4.1	Input EMI Filtering .....	7
4.2	TOPSwitch-HX Primary .....	7
4.3	Output Rectification .....	8
4.4	Output Feedback.....	9
4.5	PCB Layout .....	10
5	Bill of Materials .....	11
6	Transformer Specification.....	13
6.1	Electrical Diagram .....	13
6.2	Electrical Specifications.....	13
6.3	Materials.....	13
6.4	Transformer Build Diagram .....	14
6.5	Transformer Construction.....	15
7	Transformer Design Spreadsheet.....	16
8	Performance Data .....	20
8.1	Efficiency.....	20
8.1.1	Active Mode CEC Measurement Data.....	21
8.2	No-Load Input Power .....	22
8.3	Available Standby Output Power .....	23
9	Regulation .....	24
9.1.1	Load .....	24
9.1.2	Line .....	25
9.1.3	Cross Regulation Matrix.....	26
10	Thermal Performance .....	27
11	Waveforms.....	29
11.1	Drain Voltage and Current, Normal Operation.....	29
11.2	Output Voltage Start-up Profile.....	29
11.3	Drain Voltage and Current Start-up Profile .....	31
11.4	Load Transient Response (75% to 100% Load Step) .....	32
11.5	Output Overvoltage Protection .....	34
11.6	Output Ripple Measurements.....	35
11.6.1	Ripple Measurement Technique .....	35
11.6.2	Measurement Results .....	36
12	Line Surge.....	38
13	Control Loop Measurements.....	39
13.1	90 VAC Maximum Load.....	39
13.2	265 VAC Maximum Load.....	40
14	Conducted EMI .....	41
15	Revision History .....	42

### Important Note:



Although this board is designed to satisfy safety isolation requirements, the engineering prototype has not been agency approved. Therefore, all testing should be performed using an isolation transformer to provide the AC input to the prototype board.



## 1 Introduction

This document is an engineering report describing a LCD Monitor power supply utilizing a TOP258PN. This power supply is intended as a general purpose evaluation platform for TOPSwitch-HX.

The document contains the power supply specification, schematic, bill of materials, transformer documentation, printed circuit layout, and performance data.

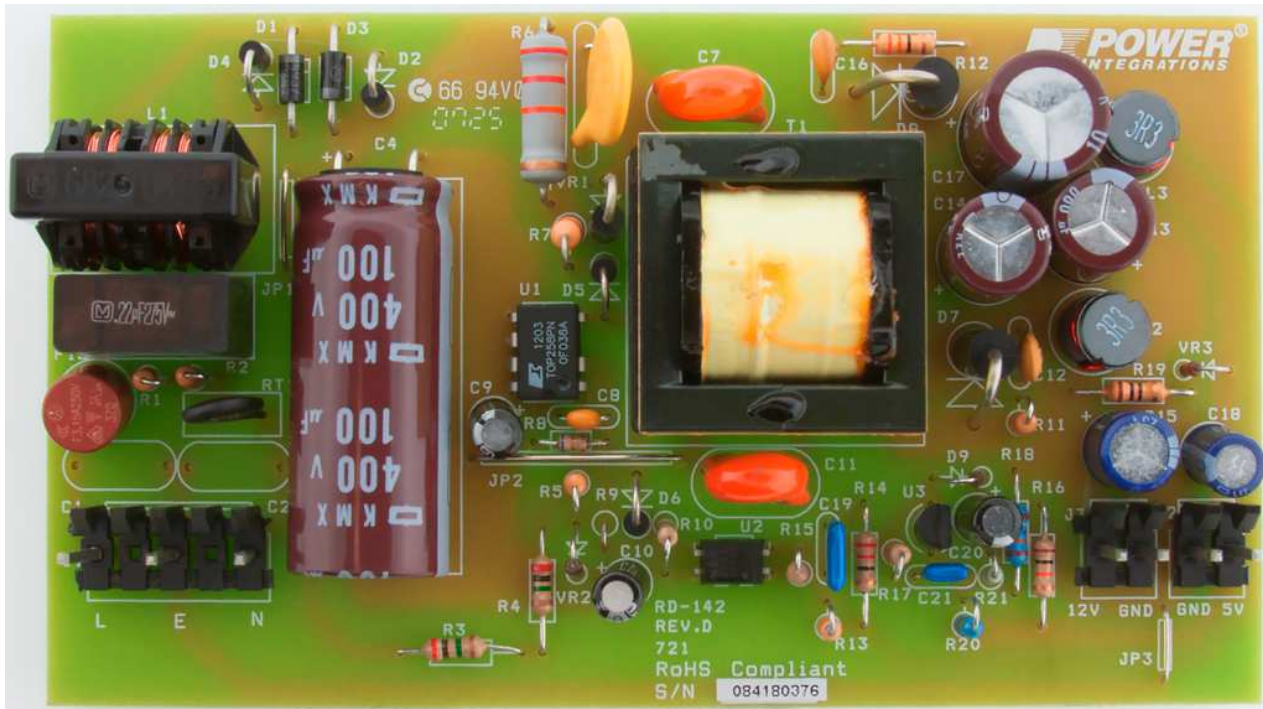


Figure 1 – Populated Circuit Board Photograph (5”L x 2.84”W x 1.16”H).



## 2 Power Supply Specification

Description	Symbol	Min	Typ	Max	Units	Comment
<b>Input</b>						
Voltage	$V_{IN}$	90		265	VAC	3 Wire Input
Frequency	$f_{LINE}$	47	50/60	64	Hz	
No-load Input Power (230 VAC)				0.3	W	
<b>Output</b>						
Output Voltage 1	$V_{OUT1}$	4.75	5	5.25	V	± 5% 20 MHz Bandwidth
Output Ripple Voltage 1	$V_{RIPPLE1}$			100	mV	
Output Current 1	$I_{OUT1}$	0		2.2	A	± 20% 20 MHz Bandwidth
Output Voltage 2	$V_{OUT2}$	9.6	12	14.4	V	
Output Ripple Voltage 2	$V_{RIPPLE2}$			500	mV	
Output Current 2	$I_{OUT2}$	0		2	A	
<b>Total Output Power</b>						
Continuous Output Power	$P_{OUT}$		35		W	
<b>Efficiency</b>						
Full Load	$\eta$	82			%	Measured at $P_{OUT}$ 25 °C 5 V @ 82 mA, 12 V @ 0 mA; $V_{IN}$ at 264 VAC
Standby Input Power				1	W	
Required Average Efficiency at 25, 50, 75 and 100 % of $P_{OUT}$	$\eta_{CEC}^*$	81			%	Per California Energy Commission (CEC) / Energy Star requirements
<b>Environmental</b>						
Conducted EMI		Meets CISPR22B / EN55022B				
Safety		Designed to meet IEC950, UL1950 Class II				
Surge						1.2/50 $\mu$ s surge, IEC 1000-4-5, Series Impedance: Differential Mode: 2 $\Omega$ Common Mode: 12 $\Omega$
Differential		1			kV	
Common Mode		2			kV	
Surge Ring Wave		1			kV	100 kHz ring wave, 500 A Short Circuit Current, Differential and Common Mode
Ambient Temperature	$T_{AMB}$	0		50	°C	Free Convection, Sea Level

\*Shown for information only as CEC requirement does not apply to internal power supplies



### 3 Schematic

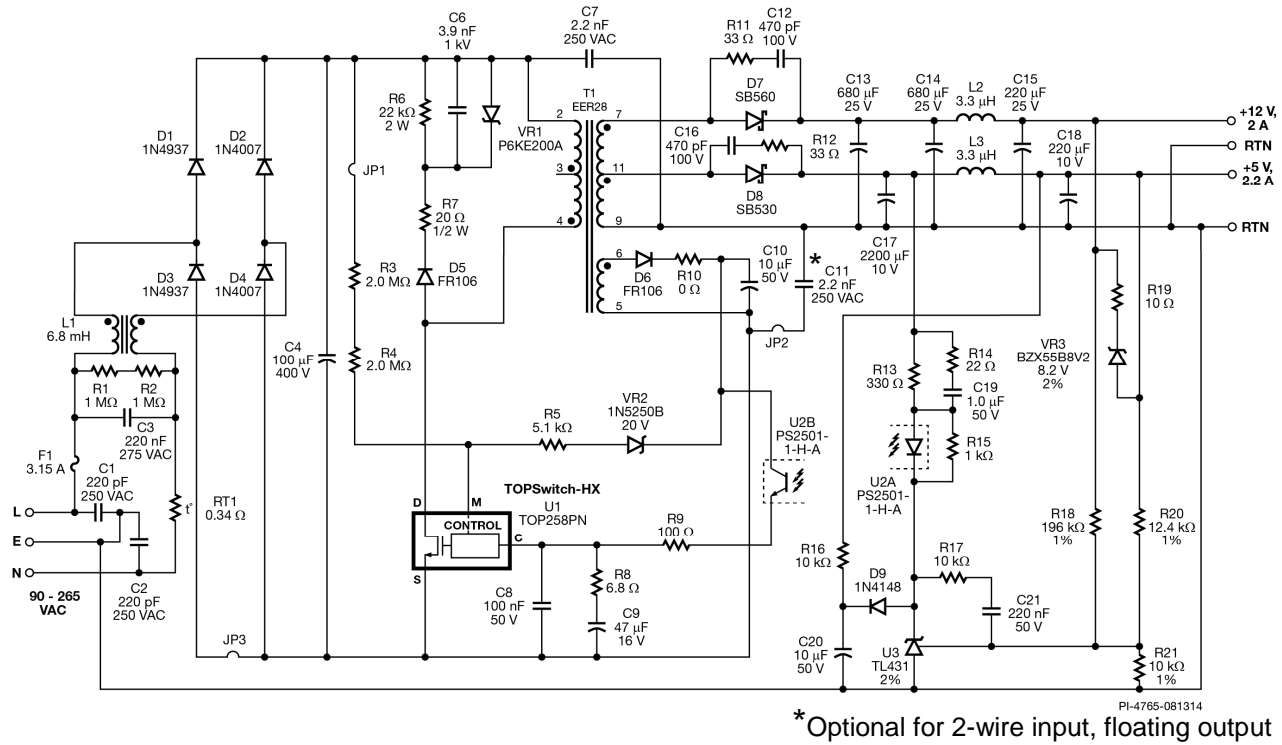


Figure 2 – Schematic.



## 4 Circuit Description

A flyback converter configuration built around TOP258PN is used in this power supply to obtain two output voltages. The 5 V output can supply a load current of 2.2 A, and the 12 V output can supply a load current of 2.0 A. This power supply can operate between 90 – 264 VAC. The 5 V output is the main regulated output. This output is regulated using a TL431 voltage reference. Some feedback is also derived from the 12 V output for improved cross regulation.

### 4.1 Input EMI Filtering

The three wire AC supply is connected to the circuit using connector J1. Fuse F1 provides protection against circuit faults and effectively isolates the circuit from the AC supply source. Thermistor RT1 limits the inrush current drawn by the circuit at start up. Optional capacitors C1 and C2 are Y capacitors connected from the Line/Neutral to Earth to reduce common mode EMI.

Capacitor C3 is the X capacitor and helps to reduce the differential mode EMI. Resistors R1 and R2 discharge C3 on AC removal, preventing potential user shock. Inductor L1 is a common-mode inductor and helps in filtering common-mode EMI from coupling back to the AC source.

Diodes D1, D2, D3 and D4 form a bridge rectifier. The bridge rectifier rectifies the incoming AC supply to DC, which is filtered by capacitor C4.

Diodes D1 and D3 are fast recovery type diodes. These diodes recover very quickly when the voltage across them reverses. This reduces excitation of stray line inductance in the AC input by reducing the subsequent high frequency turnoff snap and hence EMI. Only 2 of the 4 diodes in the bridge need to be fast recovery type, since 2 diodes conduct in each half cycle.

### 4.2 TOPSwitch-HX Primary

Resistor R3 and R4 provide line voltage sensing and provide a current to U1, which is proportional to the DC voltage across capacitor C4. At approximately 95 V DC, the current through these resistors exceeds the line under-voltage threshold of 25  $\mu$ A, which results in enabling of U1.

The TOPSwitch-HX IC regulates the output using PWM-based voltage mode control. At high loads the controller operates at full switching frequency (66 kHz for P package devices). The duty cycle is controlled based on the CONTROL pin current to regulate the output voltage.

The internal current limit provides cycle-by-cycle peak current limit protection. The TOPSwitch-HX controller has a second current limit comparator allowing monitoring the actual peak drain current ( $I_P$ ) relative to the programmed current limit  $I_{LIMITEXT}$ . As soon as the ratio  $I_P/I_{LIMITEXT}$  falls below 55%, the peak drain current is held constant. The output is



then regulated by modulating the switching frequency (variable frequency PWM control). As the load decreases further, the switching frequency decreases linearly from full frequency down to 30 kHz.

Once the switching frequency has reached 30 kHz the controller keeps this switching frequency constant and the peak current is reduced to regulate the output (fixed frequency, direct duty cycle PWM control).

As the load is further reduced and the ratio  $I_P/I_{LIMITEXT}$  falls below 25%, the controller will enter a multi-cycle-modulation mode for excellent efficiency at light load or standby operation and low no-load input power consumption.

Diode D5, together with R6, R7, C6 and Zener VR1, forms a clamp network that limits the drain voltage of U1 at the instant of turn-off. Zener VR1 provides a defined maximum clamp voltage and typically only conducts during fault conditions such as overload. This allows the RCD clamp (R6, C6 and D5) to be sized for normal operation, thereby maximizing efficiency at light load. Resistor R7 is required due to the choice of a fast recovery diode for D5. A fast versus ultrafast recovery diode allows some recovery of the clamp energy but requires R7 to limit reverse diode current and dampen high frequency ringing.

The output of the bias winding is rectified by diode D6 and filtered by resistor R10 and capacitor C10. This rectified and filtered output is used by the optocoupler U2 to provide the control current to the control terminal of U1.

Should the feedback circuit fail (open loop condition), the output of the power supply will exceed the regulation limits. This increased voltage at output will also result in an increased voltage at the output of the bias winding. Zener VR2 will break down and current will flow into the "M" pin of IC U1, thus initiating a hysteretic OVP shutdown with automatic restart attempts. Resistor R5 limits the current into the M pin; if latching OVP is desired, the value of R5 can be reduced to 20  $\Omega$ .

The output voltage of the power supply is maintained in regulation by the feedback circuit on the secondary side of the circuit. The feedback circuit controls the output voltage by changing the optocoupler current. Change in the optocoupler diode current results in a change of current into the control pin of IC U1. Variation of this current results in variation of duty cycle and hence the output voltage of the power supply.

### **4.3 Output Rectification**

Output rectification for the 5 V output is provided by diode D8. Low ESR capacitor C17 provides filtering. Inductor L3 and capacitor C18 form a second stage filter that significantly attenuates the switching ripple across C17 and ensures a low ripple output.





Output rectification for the 12 V output is provided by diode D7. Low ESR capacitors C13 and C14 provide filtering. Inductor L2 and capacitor C15 form a second stage filter that significantly attenuates the switching ripple and ensures low ripple at the output.

Snubber networks comprising R11, C12 and R12, and C16 damp high frequency ringing across diodes D7 and D8, which results from leakage inductance of the transformer windings and the secondary trace inductances.

#### **4.4 Output Feedback**

Output voltage is controlled using the shunt regulator TL431 (U3). Diode D9, capacitor C20 and resistor R16 form the soft finish circuit. At start-up, capacitor C20 is discharged. As the output voltage starts rising, current flows into the optocoupler diode (U2A) via resistor R13 and diode D9. This provides feedback to the circuit on the primary side. The current in the optocoupler diode U2A gradually decreases as capacitor C20 charges and U3 becomes operational. This ensures that the output voltage increases gradually and settles to the final value without any overshoot. Resistor R16 provides a discharge path for C20 into the load at power down. Diode D9 isolates C20 from the feedback circuit after start-up.

Resistor R18, R20 and R21 form a voltage divider network that senses the output voltage from both the outputs for better cross-regulation. Resistor R19 and Zener VR3 improve cross regulation when only the 5 V output is loaded, which results in the 12 V output operating at the higher end of the specification.

Resistors R13, R17 and capacitor C21 set the frequency response of the feedback circuit. Capacitor C19 and resistor R14 form the phase boost network that provides adequate phase margin to ensure stable operation over the entire operating voltage range.

Resistor R15 provides the bias current required by the IC U3 and is placed in parallel with U2A to ensure that the bias current to the IC does not become a part of the feedback current. Resistor R13 sets the overall DC loop gain and limits the current through U2A during transient conditions.



### 4.5 PCB Layout

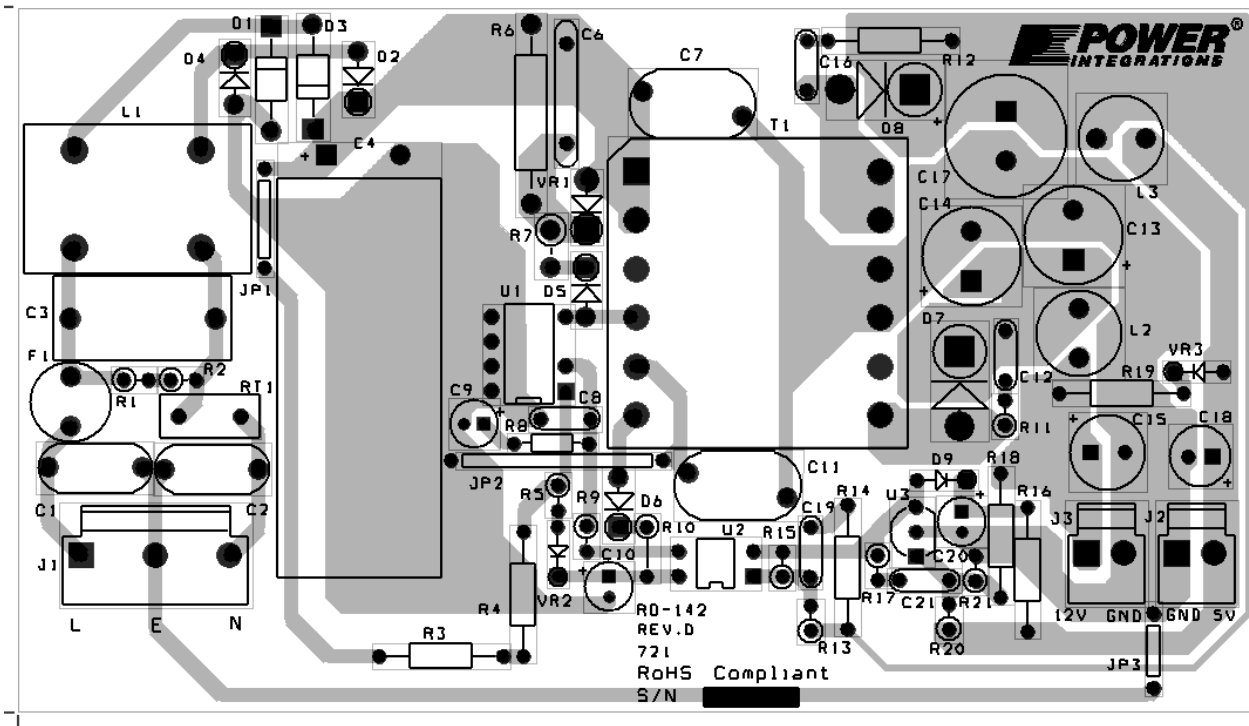


Figure 3 – Printed Circuit Layout.



## 5 Bill of Materials

Item	Qty	Ref Des	Description	Mfg Part Number	Mfg
2	1	C3	220 nF, 275 VAC, Film, X2	ECQ-U2A224ML	Panasonic
3	1	C4	100 $\mu$ F, 400 V, Electrolytic, Low ESR, 630 m $\Omega$ (16 x 40)	EKMX401ELL101ML40S	Nippon Chemi-Con
4	1	C6	3.9 nF, 1 kV, Disc Ceramic, Y5P	ECK-A3A392KBP	Panasonic
5	2	C7 C11	2.2 nF, Ceramic, Y1	440LD22-R	Vishay
6	1	C8	100 nF, 50 V, Ceramic, Z5U	C317C104M5U5TA	Kemet
7	1	C9	47 $\mu$ F, 16 V, Electrolytic, Gen Purpose, (5 x 11.5)	ECA-1CHG470	Panasonic
8	2	C10 C20	10 $\mu$ F, 50 V, Electrolytic, Gen Purpose, (5 x 11)	ECA-1HHG100	Panasonic
9	2	C12 C16	470 pF, 100 V, Ceramic, COG	5NK471KOBAM	AVX
10	2	C13 C14	680 $\mu$ F, 25 V, Electrolytic, Very Low ESR, 23 m $\Omega$ , (10 x 20)	EKZE250ELL681MJ20S	Nippon Chemi-Con
11	1	C15	220 $\mu$ F, 25 V, Electrolytic, Low ESR, 120 m $\Omega$ , (8 x 12)	ELXZ250ELL221MH12D	Nippon Chemi-Con
12	1	C17	2200 $\mu$ F, 10 V, Electrolytic, Very Low ESR, 21 m $\Omega$ , (12.5 x 20)	EKZE100ELL222MK20S	Nippon Chemi-Con
13	1	C18	220 $\mu$ F, 10 V, Electrolytic, Low ESR, 250 m $\Omega$ , (6.3 x 11.5)	ELXZ100ELL221MFB5D	Nippon Chemi-Con
14	1	C19	1.0 $\mu$ F, 50 V, Ceramic, X7R	B37984M5105K000	Epcos
15	1	C21	220 nF, 50 V, Ceramic, X7R	B37987F5224K000	Epcos
16	2	D1 D3	600 V, 1 A, Fast Recovery Diode, 200 ns, DO-41	1N4937RLG	On Semi
17	2	D2 D4	1000 V, 1 A, Rectifier, DO-41	1N4007	Vishay
18	2	D5 D6	800 V, 1 A, Fast Recovery Diode, 500 ns, DO-41	FR106	Diodes, Inc.
19	1	D7	60 V, 5 A, Schottky, DO-201AD	SB560	Vishay
20	1	D8	30 V, 5 A, Schottky, DO-201AD	SB530	Fairchild
21	1	D9	75 V, 300 mA, Fast Switching, DO-35	1N4148	Vishay
22	1	F1	3.15 A, 250V, Fast, TR5	37013150410	Wickman
23	1	J1	5 Position (1 x 5) header, 0.156 pitch	26-48-1055	Molex
24	2	J2 J3	2 Position (1 x 2) header, 0.156 pitch	26-48-1025	Molex
25	1	JP1	Wire Jumper, Non insulated, #22 AWG, 0.4 in	298	Alpha
26	1	JP2	Wire Jumper, Non insulated, #22 AWG, 0.8 in	298	Alpha
27	1	JP3	Wire Jumper, Non insulated, #22 AWG, 0.3 in	298	Alpha
28	1	L1	6.8 mH, 0.8 A, Common Mode Choke	ELF15N008	Panasonic
29	2	L2 L3	3.3 $\mu$ H, 5.0 A	RFB0807-3R3L	Coilcraft
30	2	R1 R2	1 M $\Omega$ , 5%, 1/4 W, Carbon Film	CFR-25JB-1M0	Yageo
31	2	R3 R4	2.0 M $\Omega$ , 5%, 1/4 W, Carbon Film	CFR-25JB-2M0	Yageo
32	1	R5	5.1 k $\Omega$ , 5%, 1/4 W, Carbon Film	CFR-25JB-5K1	Yageo
33	1	R6	22 k $\Omega$ , 5%, 2 W, Metal Oxide	RSF200JB-22K	Yageo
34	1	R7	20 $\Omega$ , 5%, 1/2 W, Carbon Film	CFR-50JB-20R	Yageo
35	1	R8	6.8 $\Omega$ , 5%, 1/8 W, Carbon Film	CFR-12JB-6R8	Yageo
36	1	R9	100 $\Omega$ , 5%, 1/4 W, Carbon Film	CFR-25JB-100R	Yageo
37	1	R10	0 $\Omega$ , 5%, 1/4 W, Carbon Film	ZOR-25-B-52-0R	Yageo
38	2	R11 R12	33 $\Omega$ , 5%, 1/4 W, Carbon Film	CFR-25JB-33R	Yageo
39	1	R13	330 $\Omega$ , 5%, 1/4 W, Carbon Film	CFR-25JB-330R	Yageo
40	1	R14	22 $\Omega$ , 5%, 1/4 W, Carbon Film	CFR-25JB-22R	Yageo
41	1	R15	1 k $\Omega$ , 5%, 1/4 W, Carbon Film	CFR-25JB-1K0	Yageo
42	2	R16 R17	10 k $\Omega$ , 5%, 1/4 W, Carbon Film	CFR-25JB-10K	Yageo
43	1	R18	196 k $\Omega$ , 1%, 1/4 W, Metal Film	MFR-25FBF-196K	Yageo
44	1	R19	10 $\Omega$ , 5%, 1/4 W, Carbon Film	CFR-25JB-10R	Yageo
45	1	R20	12.4 k $\Omega$ , 1%, 1/4 W, Metal Film	MFR-25FBF-12K4	Yageo
46	1	R21	10 k $\Omega$ , 1%, 1/4 W, Metal Film	ERO-S2PHF1002	Panasonic
47	1	RT1	NTC Thermistor, 10 $\Omega$ , 1.7 A	CL-120	Thermometrics
48	1	T1	Core Bobbin: EER28, Horizontal, 12 pins (6/6),	PC40EER28-Z YC-2806-5	TDK Ying-Chin



			Complete Assembly (custom)	TP07074 32/07 TR.RDK-142 019-4967-00R SNX R1359	Ice Components Magtel Precision Inc. Santronics
49	1	U1	TOPSwitch-HX, DIP-8B	TOP258PN	Power Integrations
50	1	U2	Optocoupler, 80 V, CTR 80-160%, 4-DIP	PS2501-1-H-A	NEC
51	1	U3	2.495 V Shunt Regulator IC, 2%, 0 to 70C, TO-92	TL431CLPG	On Semi
52	1	VR1	200 V, 600 W, 5%, TVS, DO204AC (DO-15)	P6KE200ARLG	On Semi
53	1	VR2	20 V, 5%, 500 mW, DO-35	1N5250B	Microsemi
54	1	VR3	8.2 V, 500 mW, 2%, DO-35	BZX55B8V2	Vishay

Note – Parts listed above are RoHS compliant



## 6 Transformer Specification

### 6.1 Electrical Diagram

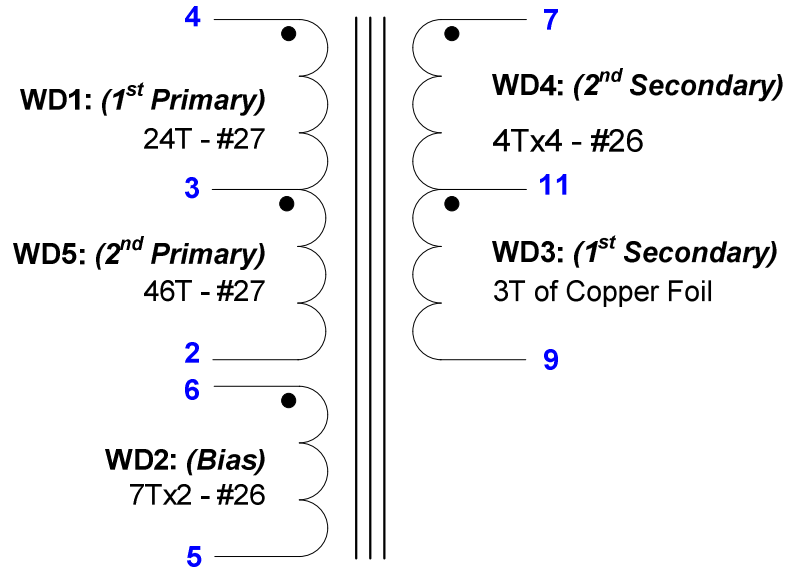


Figure 4 – Transformer Electrical Diagram.

### 6.2 Electrical Specifications

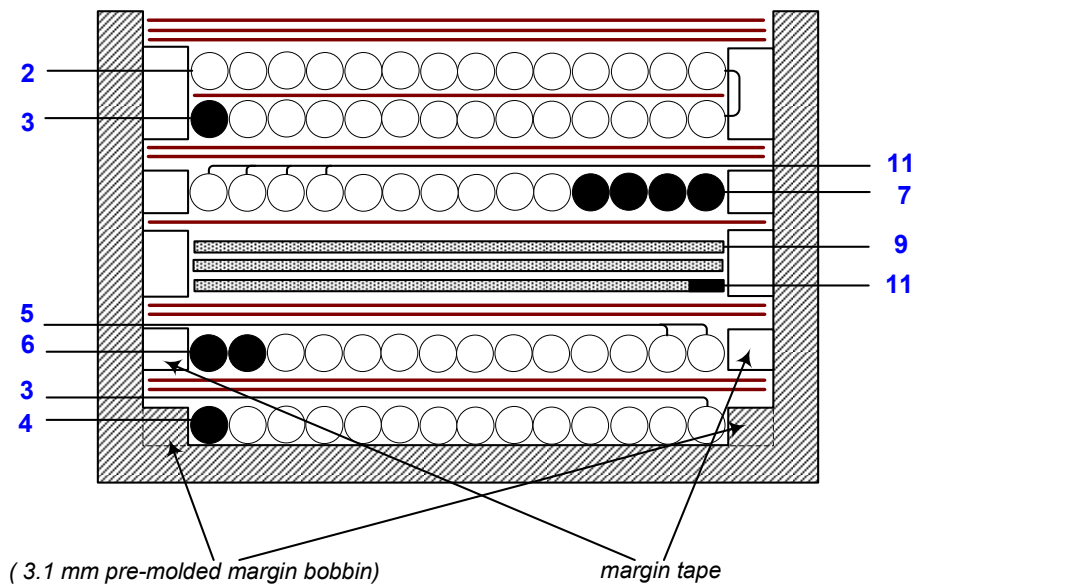
<b>Electrical Strength</b>	1 second, 60 Hz, from pins 2, 3, 4, 5, 6 to pins 7, 9, 11.	3000 VAC
<b>Primary Inductance</b>	Pins 2-4, all other windings open, measured at 100 kHz, 0.4 V <sub>RMS</sub> .	1040 μH, ±10%
<b>Resonant Frequency</b>	Pins 2-4, all other windings open.	1000 kHz (Min.)
<b>Primary Leakage Inductance</b>	Pins 2-4, with Pins 7-9 shorted, measured at 100 kHz, 0.4 V <sub>RMS</sub> .	20 μH (Max.)

### 6.3 Materials

Item	Description
[1]	Core: EER28 gapped for ALG of 213 nH/T <sup>2</sup> .
[2]	Bobbin: EER28, Horizontal 12 pins (6/6), YC-2806-5.
[3]	Magnet Wire: #27 AWG, double coated.
[4]	Magnet Wire: #26 AWG, double coated.
[5]	Tape: 3M Polyester Film, 2.0 mils thick, 16.0 mm wide.
[6]	Tape: 3M Polyester Film, 2.0 mils thick, 10.0 mm wide.
[7]	Copper Foil, 2 mils thick, 142 mm long, 8.5 mm wide. To be wrapped over with tape item [6].
[8]	Tape: 3M Polyester Film, 2.0 mils thick, 13.5 mm wide.
[9]	Bare Wire: #28 AWG.
[10]	Tape: 3M Polyester Film, 2.0 mils thick, 8.0 mm wide.
[11]	Varnish.
[12]	Polyester Web Margin Tape 3.1 mm wide.

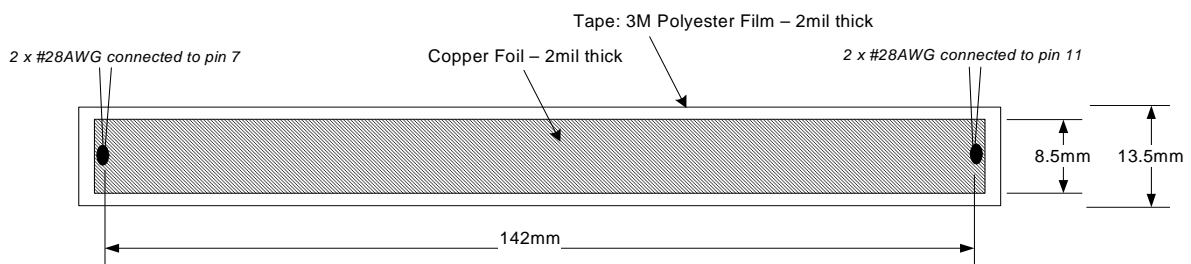


### 6.4 Transformer Build Diagram



**Bobbin:** EER28 (Horizontal, 12pins, 6/6), YC-2806-5)

**Lp(2-4):** 1.04mH +/- 5%



**Figure 5 – Transformer Build Diagram.**



### 6.5 Transformer Construction

<b>General Note</b>	Primary side of the bobbin orients to the left hand side. Place 3.1 mm margin tape on both sides for all windings except WD1 due to built-in 3.1 mm margin of bobbin [12]. Winding direction is clockwise.
<b>WD1 1/2 Primary</b>	Start on pin 4, wind 24 turns of item [3] from left to right with tight tension and bring the wire across the bobbin to terminate at pin 3.
<b>Insulation</b>	2 layers of tape item [5].
<b>WD2 Bias</b>	Start on pin 6, wind 7 turns bifilar of item [4] from left to right, spread the winding evenly, and bring the wire across the bobbin to terminate on pin 5.
<b>Insulation</b>	2 layers of tape item [5].
<b>WD3 1<sup>st</sup> Secondary</b>	Start on pin 11, wind 3 turns of item [7] and terminate at pin 9.
<b>Insulation</b>	1 layer of tape item [5].
<b>WD4 2<sup>nd</sup> Secondary</b>	Start on pin 7, wind 4 turns quadfilar of item [4] from right to left, spread the winding evenly across the bobbin, and bring the wire back to the right to terminate on pin 11.
<b>Insulation</b>	2 layers of tape item [5].
<b>WD5 2/2 Primary</b>	Start on pin 3, wind 23 turns of item [3] from left to right with tight tension, place 1 layer tape item [6], then wind another 23 turns of item [3] from right to left, also with tight tension, and terminate at pin 2.
<b>Insulation</b>	3 layers of tape item [5].
<b>Assembly</b>	Grind the cores to get 1038 $\mu\text{H}$ with ALG of 213 $\text{nH/T}^2$ .
<b>Finish</b>	Secure the cores by wrapping around 2 halves of cores with item [10]. Dip varnish uniformly in item [11].



## 7 Transformer Design Spreadsheet

ACDC_TOPSwitchHX_09 0607; Rev.1.2; Copyright Power Integrations 2007	INPUT	INFO	OUTPUT	UNIT	TOPSwitch_HX_090607: TOPSwitch-HX Continuous/Discontinuous Flyback Transformer Design Spreadsheet
<b>ENTER APPLICATION VARIABLES</b>					<b>RD-142</b>
VACMIN	90			Volts	Minimum AC Input Voltage
VACMAX	265			Volts	Maximum AC Input Voltage
fL	50			Hertz	AC Mains Frequency
VO	5.00			Volts	Output Voltage (main)
PO_AVG	35.00			Watts	Average Output Power
PO_PEAK			35.00	Watts	Peak Output Power
n	0.80			%/100	Efficiency Estimate
Z	0.50				Loss Allocation Factor
VB	12	Info		Volts	Ensure proper operation at no load.
tC	3.00			mSeconds	Bridge Rectifier Conduction Time Estimate
CIN	100.0		100	uFarads	Input Filter Capacitor
<b>ENTER TOPSWITCH-HX VARIABLES</b>					
<b>TOPSwitch-HX</b>	<b>TOP258PN</b>			Universal / Peak	115 Doubled/230V
Chosen Device		TOP258 PN	Power Out	35 W / 50 W	48W
KI	1.00				External Ilimit reduction factor (KI=1.0 for default ILIMIT, KI <1.0 for lower ILIMIT)
ILIMITMIN_EXT			1.534	Amps	Use 1% resistor in setting external ILIMIT
ILIMITMAX_EXT			1.766	Amps	Use 1% resistor in setting external ILIMIT
Frequency (F)=132kHz, (H)=66kHz	<b>H</b>		H		Only half frequency option available for P, G and M package devices. For full frequency operation choose Y package.
fS			66000	Hertz	TOPSwitch-HX Switching Frequency: Choose between 132 kHz and 66 kHz
fSmin			59400	Hertz	TOPSwitch-HX Minimum Switching Frequency
fSmax			72600	Hertz	TOPSwitch-HX Maximum Switching Frequency
High Line Operating Mode			FF		
VOR	128.00			Volts	Reflected Output Voltage
VDS	5.63		5.63	Volts	TOPSwitch on-state Drain to Source Voltage
VD	0.50			Volts	Output Winding Diode Forward Voltage Drop
VDB	0.70			Volts	Bias Winding Diode Forward Voltage Drop
KP	0.69				Ripple to Peak Current Ratio (0.3 < KRP < 1.0 : 1.0 < KDP < 6.0)
<b>PROTECTION FEATURES</b>					
<b>LINE SENSING</b>					Note - For P/G package devices only one of either Line sensing or Overload power limiting protection features can be used. For all other packages both these functions can be simultaneously used.
VUV_STARTUP	95.00		95	Volts	DC Bus Voltage at which the power supply will start-up
VOV_SHUTDOWN			445	Volts	DC Bus Voltage at which power supply will shut-down
RLS			4.0	M-ohms	Use two standard, 2 MΩ, 5% resistors in series for line sense functionality.
<b>OUTPUT OVERVOLTAGE</b>					
VZ			22	Volts	Zener Diode rated voltage for Output Overvoltage shutdown protection
RZ			5.1	k-ohms	Output OVP resistor. For latching shutdown use 20 ohm resistor instead
<b>OVERLOAD POWER LIMITING</b>					
Overload Current Ratio at VMAX			1.2		Enter the desired margin to current limit at





					VMAX. A value of 1.2 indicates that the current limit should be 20% higher than peak primary current at VMAX
Overload Current Ratio at VMIN			1.25		Margin to current limit at low line.
ILIMIT_EXT_VMIN			1.23	A	External Current limit at VMIN
ILIMIT_EXT_VMAX			1.14	A	External Current limit at VMAX
RIL			8.29	k-ohms	Current limit/Power Limiting resistor.
RPL			29.27	M-ohms	Power Limiting resistor
<b>ENTER TRANSFORMER CORE/CONSTRUCTION VARIABLES</b>					
<b>Core Type</b>	<b>EER28</b>		<b>EER28</b>		<b>Core Type</b>
Core		EER28		P/N:	PC40EER28-Z
Bobbin		EER28_BOBBIN		P/N:	
AE			0.821	cm <sup>2</sup>	Core Effective Cross Sectional Area
LE			6.4	cm	Core Effective Path Length
AL			2870	nH/T <sup>2</sup>	Ungapped Core Effective Inductance
BW			16.7	mm	Bobbin Physical Winding Width
M	3.00			mm	Safety Margin Width (Half the Primary to Secondary Creepage Distance)
L	3.00				Number of Primary Layers
NS	3		3		Number of Secondary Turns
<b>DC INPUT VOLTAGE PARAMETERS</b>					
VMIN			100	Volts	Minimum DC Input Voltage
VMAX			375	Volts	Maximum DC Input Voltage
<b>CURRENT WAVEFORM SHAPE PARAMETERS</b>					
DMAX			0.57		Maximum Duty Cycle (calculated at PO_PEAK)
IAVG			0.44	Amps	Average Primary Current (calculated at average output power)
IP			1.16	Amps	Peak Primary Current (calculated at Peak output power)
IR			0.80	Amps	Primary Ripple Current (calculated at average output power)
IRMS			0.60	Amps	Primary RMS Current (calculated at average output power)
<b>TRANSFORMER PRIMARY DESIGN PARAMETERS</b>					
LP			1040	uHenries	Primary Inductance
LP Tolerance			10		Tolerance of Primary Inductance
NP			70		Primary Winding Number of Turns
NB			7		Bias Winding Number of Turns
ALG			213	nH/T <sup>2</sup>	Gapped Core Effective Inductance
BM			2101	Gauss	Maximum Flux Density at PO, VMIN (BM<3000)
BP			3524	Gauss	Peak Flux Density (BP<4200) at ILIMITMAX and LP_MAX. Note: Recommended values for adapters and external power supplies <=3600 Gauss
BAC			725	Gauss	AC Flux Density for Core Loss Curves (0.5 X Peak to Peak)
ur			1780		Relative Permeability of Ungapped Core
LG			0.45	mm	Gap Length (Lg > 0.1 mm)
BWE			32.1	mm	Effective Bobbin Width
OD			0.46	mm	Maximum Primary Wire Diameter including insulation
INS			0.06	mm	Estimated Total Insulation Thickness (= 2 * film thickness)
DIA			0.40	mm	Bare conductor diameter
AWG			27	AWG	Primary Wire Gauge (Rounded to next smaller standard AWG value)
CM			203	Cmils	Bare conductor effective area in circular mils
CMA			338	Cmils/Amp	Primary Winding Current Capacity (200 < CMA < 500)
Primary Current Density (J)			5.88	Amps/mm <sup>2</sup>	Primary Winding Current density (3.8 < J < 9.75)



<b>TRANSFORMER SECONDARY DESIGN PARAMETERS (SINGLE OUTPUT EQUIVALENT)</b>					
<b>Lumped parameters</b>					
ISP			26.95	Amps	Peak Secondary Current
ISRMS			12.03	Amps	Secondary RMS Current
IO_PEAK			7.00	Amps	Secondary Peak Output Current
IO			7.00	Amps	Average Power Supply Output Current
IRIPPLE			9.79	Amps	Output Capacitor RMS Ripple Current
CMS			2407	Cmils	Secondary Bare Conductor minimum circular mils
AWGS			16	AWG	Secondary Wire Gauge (Rounded up to next larger standard AWG value)
DIAS			1.29	mm	Secondary Minimum Bare Conductor Diameter
ODS			3.57	mm	Secondary Maximum Outside Diameter for Triple Insulated Wire
INSS			1.14	mm	Maximum Secondary Insulation Wall Thickness
<b>VOLTAGE STRESS PARAMETERS</b>					
VDRAIN			625	Volts	Maximum Drain Voltage Estimate (Includes Effect of Leakage Inductance)
PIVS			21	Volts	Output Rectifier Maximum Peak Inverse Voltage
PIVB			49	Volts	Bias Rectifier Maximum Peak Inverse Voltage
<b>TRANSFORMER SECONDARY DESIGN PARAMETERS (MULTIPLE OUTPUTS)</b>					
<b>1st output</b>					
VO1	5.00		5	Volts	Output Voltage
IO1_AVG	2.20		2.2	Amps	Average DC Output Current
PO1_AVG			11.00	Watts	Average Output Power
VD1			0.5	Volts	Output Diode Forward Voltage Drop
NS1			3.00		Output Winding Number of Turns
ISRMS1			3.782	Amps	Output Winding RMS Current
IRIPPLE1			3.08	Amps	Output Capacitor RMS Ripple Current
PIVS1			21	Volts	Output Rectifier Maximum Peak Inverse Voltage
CMS1			756	Cmils	Output Winding Bare Conductor minimum circular mils
AWGS1			21	AWG	Wire Gauge (Rounded up to next larger standard AWG value)
DIAS1			0.73	mm	Minimum Bare Conductor Diameter
ODS1			3.57	mm	Maximum Outside Diameter for Triple Insulated Wire
<b>2nd output</b>					
VO2	12.00			Volts	Output Voltage
IO2_AVG	2.00			Amps	Average DC Output Current
PO2_AVG			24.00	Watts	Average Output Power
VD2			0.7	Volts	Output Diode Forward Voltage Drop
NS2			6.93		Output Winding Number of Turns
ISRMS2			3.438	Amps	Output Winding RMS Current
IRIPPLE2			2.80	Amps	Output Capacitor RMS Ripple Current
PIVS2			49	Volts	Output Rectifier Maximum Peak Inverse Voltage
CMS2			688	Cmils	Output Winding Bare Conductor minimum circular mils
AWGS2			21	AWG	Wire Gauge (Rounded up to next larger standard AWG value)
DIAS2			0.73	mm	Minimum Bare Conductor Diameter
ODS2			1.54	mm	Maximum Outside Diameter for Triple Insulated Wire
<b>3rd output</b>					
VO3				Volts	Output Voltage
IO3_AVG				Amps	Average DC Output Current
PO3_AVG			0.00	Watts	Average Output Power
VD3			0.7	Volts	Output Diode Forward Voltage Drop



NS3			0.38		Output Winding Number of Turns
ISRMS3			0.000	Amps	Output Winding RMS Current
IRIPPLE3			0.00	Amps	Output Capacitor RMS Ripple Current
PIVS3			2	Volts	Output Rectifier Maximum Peak Inverse Voltage
CMS3			0	Cmils	Output Winding Bare Conductor minimum circular mils
AWGS3			N/A	AWG	Wire Gauge (Rounded up to next larger standard AWG value)
DIAS3			N/A	mm	Minimum Bare Conductor Diameter
ODS3			N/A	mm	Maximum Outside Diameter for Triple Insulated Wire
<b>Total Continuous Output Power</b>			35	Watts	Total Continuous Output Power
Negative Output			N/A		If negative output exists enter Output number; eg: If VO2 is negative output, enter 2



## 8 Performance Data

All measurements performed at room temperature, 60 Hz input frequency.

### 8.1 Efficiency

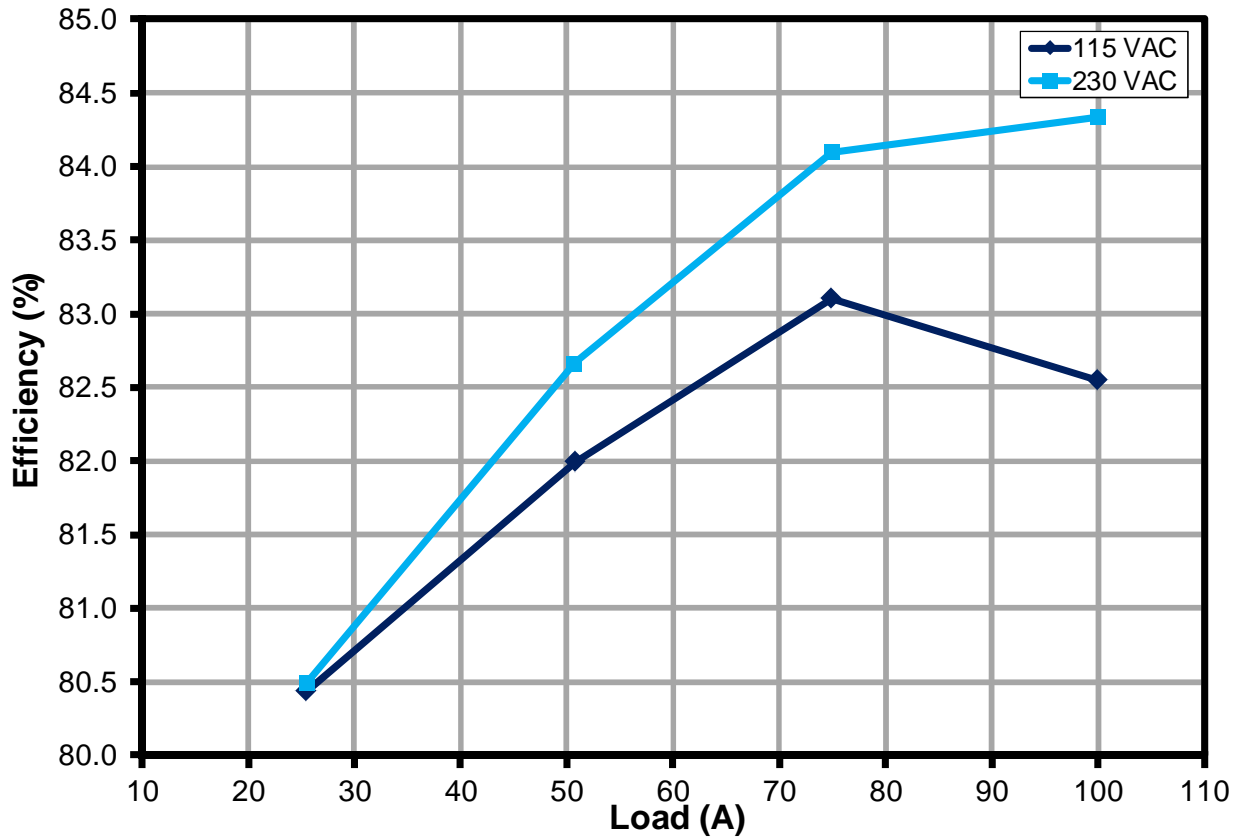


Figure 6 – Efficiency vs. Input Voltage, Room Temperature, 60 Hz.



### 8.1.1 Active Mode CEC Measurement Data

All single output adapters, including those provided with products, for sale in California after Jan 1<sup>st</sup>, 2008 must meet the California Energy Commission (CEC) requirement for minimum active mode efficiency and no load input power. Minimum active mode efficiency is defined as the average efficiency of 25, 50, 75 and 100% of rated output power with the limit based on the nameplate output power:

Nameplate Output ( $P_o$ )	Minimum Efficiency in Active Mode of Operation
< 1 W	$0.49 \times P_o$
$\geq 1 \text{ W to } \leq 49 \text{ W}$	$0.09 \times \ln(P_o) + 0.5$ [ln = natural log]
> 49 W	0.85

For adapters that are single input voltage only, then the measurement is made at the rated single nominal input voltage (115 VAC or 230 VAC); for universal input adapters the measurement is made at both nominal input voltages (115 VAC and 230 VAC).

To meet the standard, the measured average efficiency (or efficiencies for universal input supplies) must be greater than or equal to the efficiency specified by the CEC/Energy Star standard.

Percent of Full Load	Efficiency (%)	
	115 VAC	230 VAC
25	80.4366	80.49
50	81.9952	82.65
75	83.0973	84.09
100	82.5686	84.33
Average	82.02	82.89
CEC specified minimum average efficiency (%)	82.0*	

\*Although the CEC standard does not apply to this design, the data is provided for reference.

More states within the USA and other countries are adopting this standard, for the latest up to date information please visit the PI Green Room:

<http://www.powerint.com/greenroom/regulations.htm>



### 8.2 No-Load Input Power

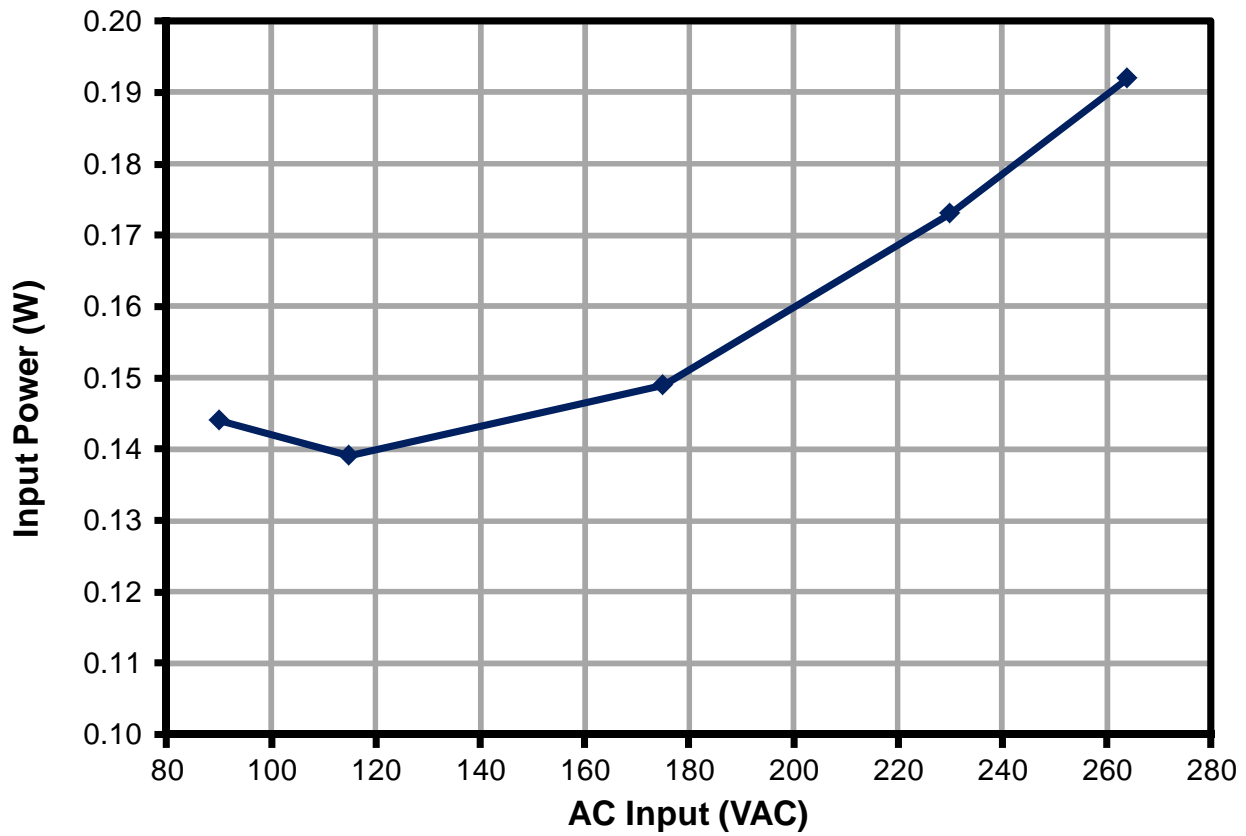


Figure 7 – Zero Load Input Power vs. Input Line Voltage, Room Temperature, 60 Hz.



### 8.3 Available Standby Output Power

The chart below shows the available output power vs line voltage for an input power of 1 W, 2 W and 3 W. This measurement was taken by loading the 5 V output.

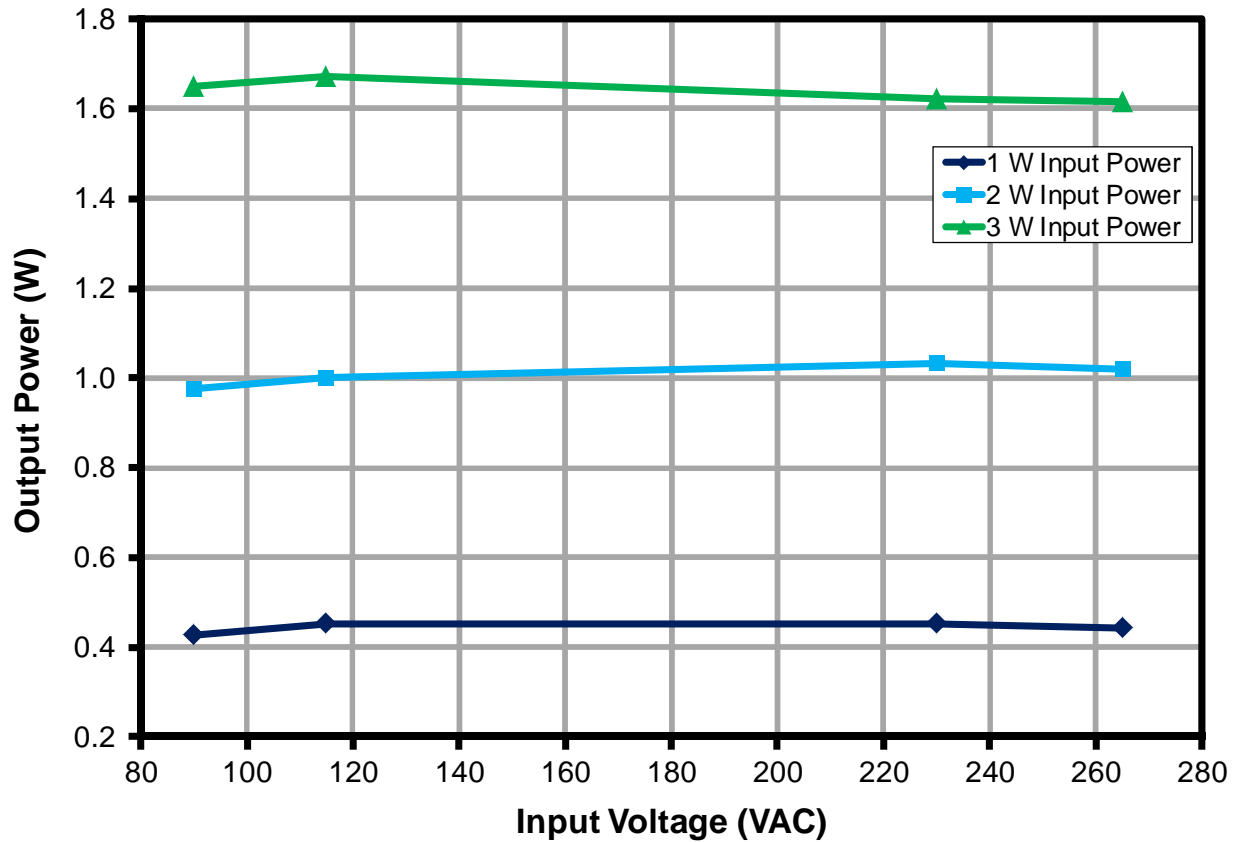


Figure 8 – Available Standby Output Power for Fixed Levels of Input Power.



## 9 Regulation

### 9.1.1 Load

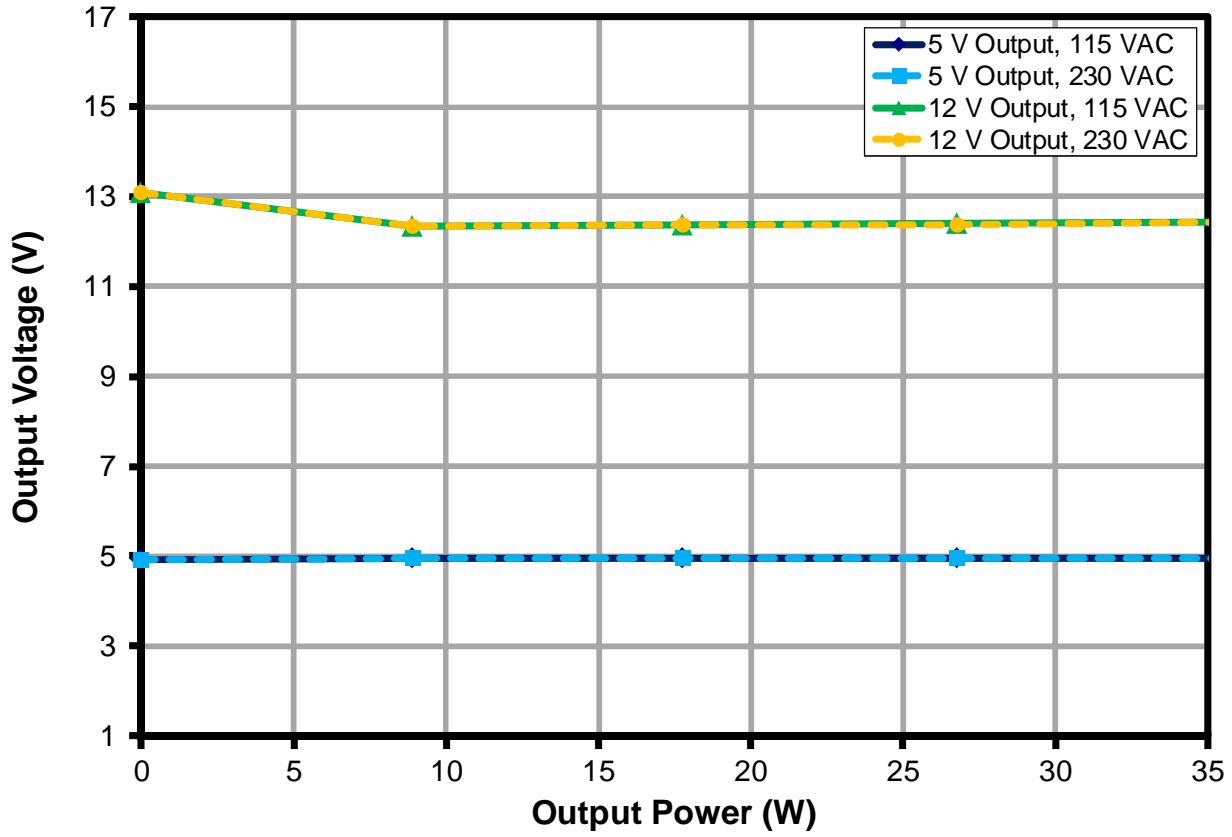


Figure 9 – Load Regulation, Room Temperature.





9.1.2 Line

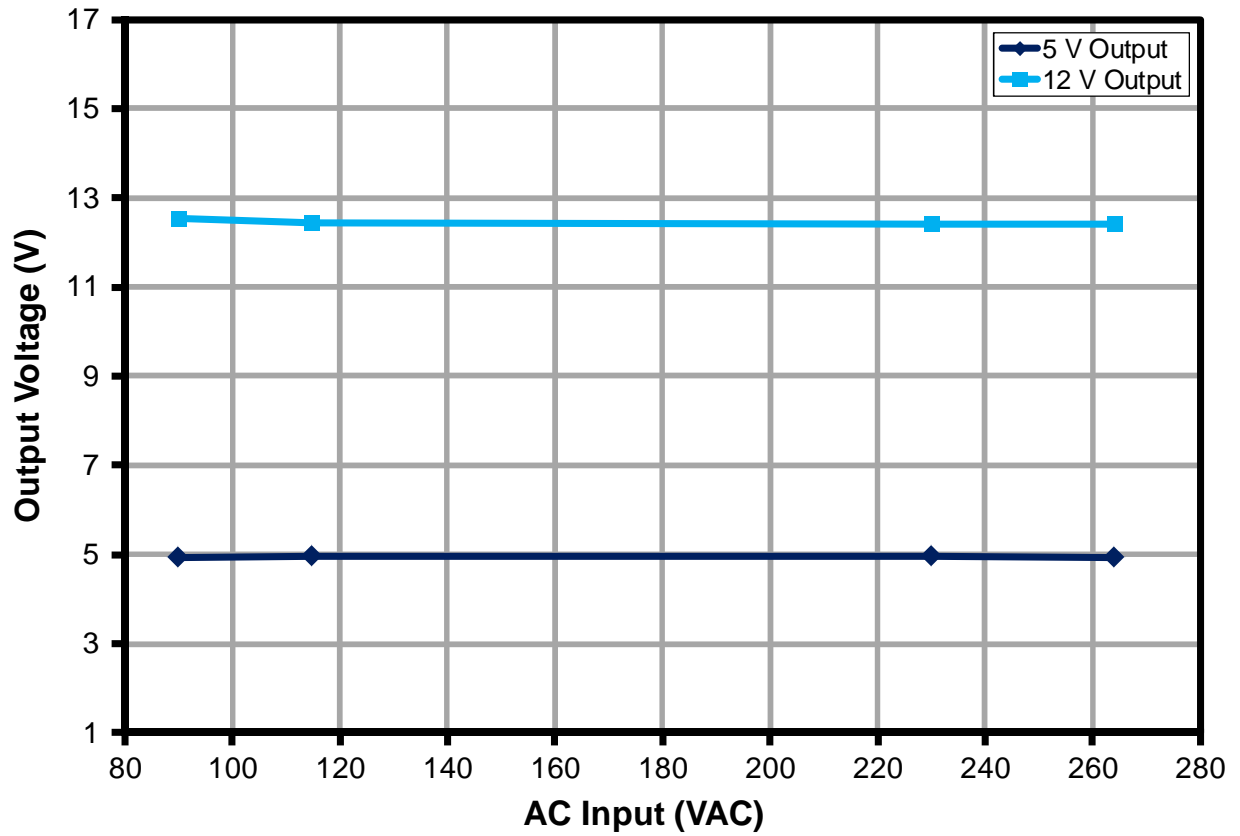


Figure 10 – Line Regulation, Room Temperature, Full Load.



## 9.1.3 Cross Regulation Matrix

The table below shows the data for the outputs under various loading conditions at 90 and 265 VAC. The regulation on the 5 V output was within  $\pm 5\%$  under all conditions.

90 VAC Constant 50 mA Load on 12 V				265 VAC Constant 50 mA Load on 12 V			
I <sub>o</sub> (12 V)	I <sub>o</sub> (5 V)	V <sub>o</sub> (5 V)	V <sub>o</sub> (12 V)	I <sub>o</sub> (12 V)	I <sub>o</sub> (5 V)	V <sub>o</sub> (5 V)	V <sub>o</sub> (12 V)
0.05	0.05	4.96	12.23	0.05	0.05	4.95	12.27
0.05	0.5	4.9	13.12	0.05	0.5	4.89	13.2
0.05	1	4.85	13.82	0.05	1	4.85	13.95
0.05	1.5	4.82	14.4	0.05	1.5	4.8	14.64
0.05	2.2	4.79	14.9	0.05	2.2	4.78	14.98

90 VAC - 12 V Held Constant at Full Load				265 VAC - 12 V Held Constant at Full Load			
I <sub>o</sub> (12 V)	I <sub>o</sub> (5 V)	V <sub>o</sub> (5 V)	V <sub>o</sub> (12 V)	I <sub>o</sub> (12 V)	I <sub>o</sub> (5 V)	V <sub>o</sub> (5 V)	V <sub>o</sub> (12 V)
2	0.05	4.99	11.7	2	0.05	4.99	11.66
2	0.5	4.97	12	2	0.5	4.97	11.97
2	1	4.96	12.14	2	1	4.96	12.1
2	1.5	4.95	12.27	2	1.5	4.95	12.22
2	2.2	4.94	12.4	2	2.2	4.94	12.33

90 VAC Constant 50 mA Load on 5 V				265 VAC Constant 50 mA Load on 5 V			
I <sub>o</sub> (5 V)	I <sub>o</sub> (12 V)	V <sub>o</sub> (12 V)	V <sub>o</sub> (5 V)	I <sub>o</sub> (5 V)	I <sub>o</sub> (12 V)	V <sub>o</sub> (12 V)	V <sub>o</sub> (5 V)
0.05	0.05	12.26	4.95	0.05	0.05	12.27	4.95
0.05	0.5	11.91	4.97	0.05	0.5	11.91	4.99
0.05	1	11.79	4.98	0.05	1	11.76	4.99
0.05	1.5	11.73	4.98	0.05	1.5	11.69	4.99
0.05	2	11.68	4.98	0.05	2	11.63	4.99

90 VAC Constant 2.2 A Load on 5 V				265 VAC Constant 2.2 A Load on 5 V			
I <sub>o</sub> (5 V)	I <sub>o</sub> (12 V)	V <sub>o</sub> (12 V)	V <sub>o</sub> (5 V)	I <sub>o</sub> (5 V)	I <sub>o</sub> (12 V)	V <sub>o</sub> (12 V)	V <sub>o</sub> (5 V)
2.2	0.05	14.96	4.78	2.2	0.05	14.87	4.8
2.2	0.5	12.91	4.91	2.2	0.5	12.96	4.91
2.2	1	12.54	4.94	2.2	1	12.55	4.93
2.2	1.5	12.42	4.94	2.2	1.5	12.98	4.94
2.2	2	12.36	4.94	2.2	2	12.32	4.94

**Table 1** – Cross Regulation Data Under Various Loading Conditions.



## 10 Thermal Performance

Measurements were taken with no air flow across the power supply.

Item	90 VAC (°C)
Ambient	28.6
Output Capacitor (C17)	62.9
Transformer (T1)	84.6
Clamp Diode	105.8
TOPSwitch (U1)	98.6
Rectifier (D8)	80.8

Table 2 – Thermal Performance, Full Load.

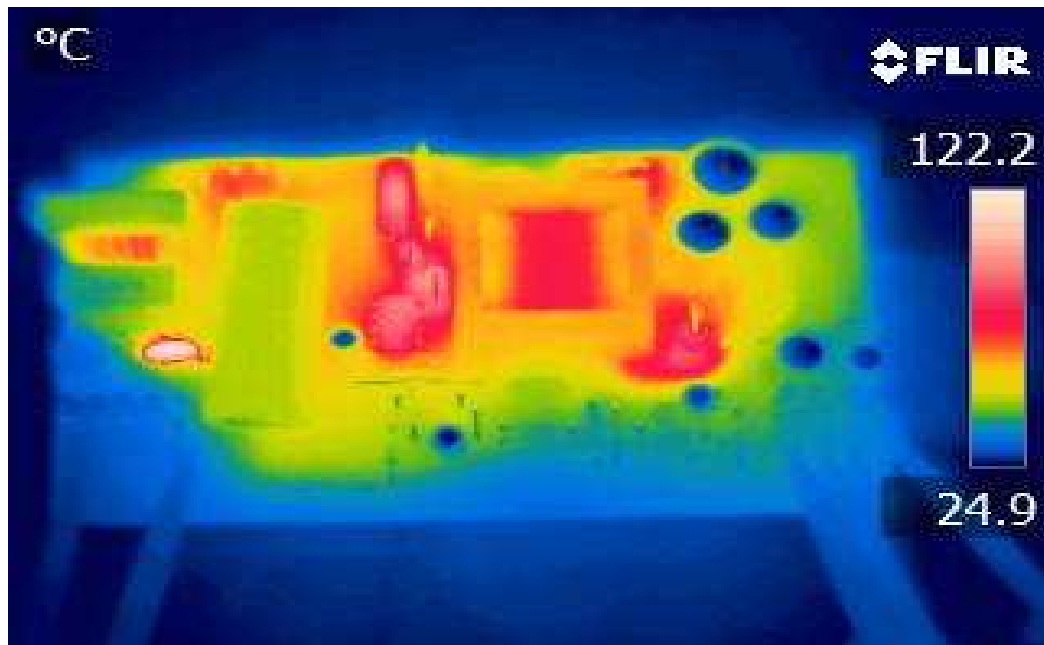
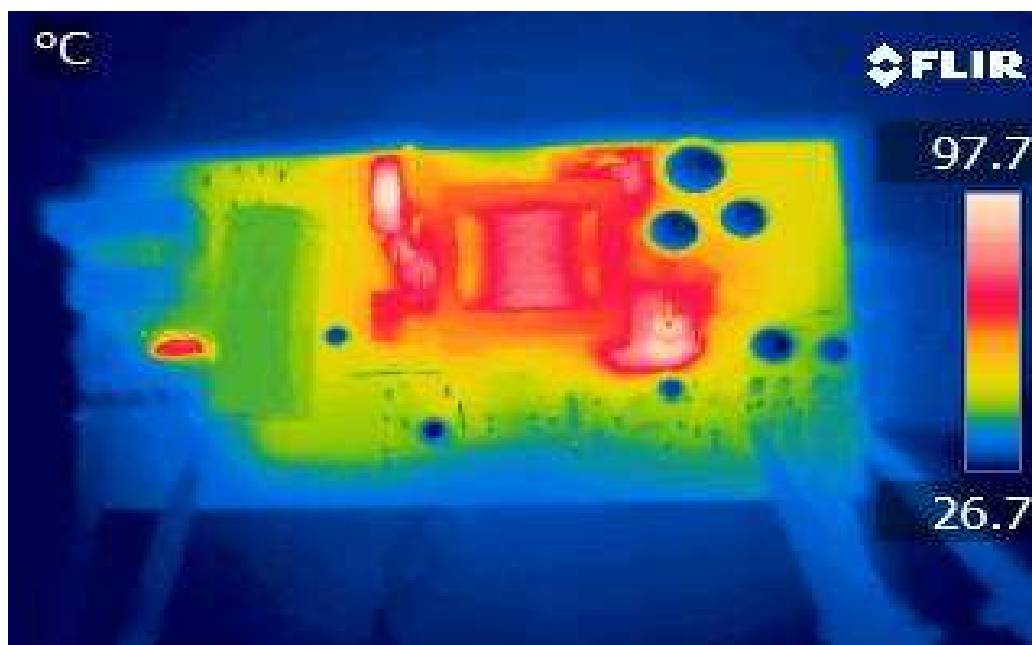


Figure 11 – Infrared Thermograph of Open Frame Operation, at Room Temperature.  
90 VAC, 35 W Load, 28.6 °C Ambient.

Item	265 VAC (°C)
Ambient	28.4
Output Capacitor (C17)	59.4
Transformer (T1)	82.4
Clamp Diode	83
TOPSwitch (U1)	72.7
Rectifier (D8)	81.5

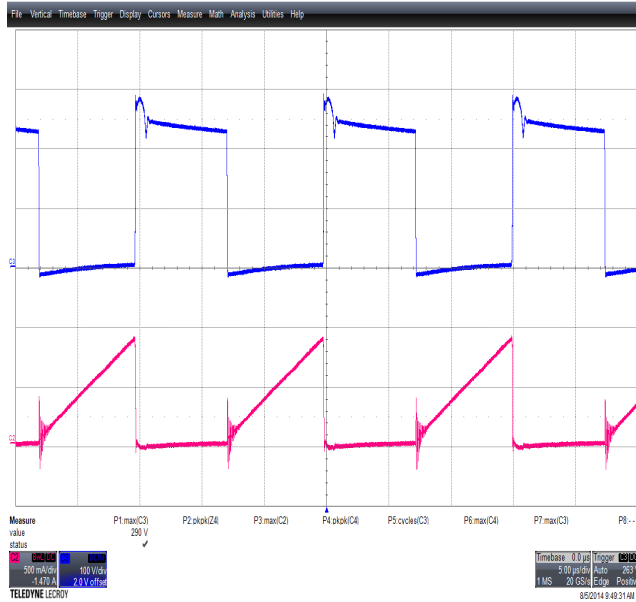
**Table 3** – Thermal Performance, Full Load.



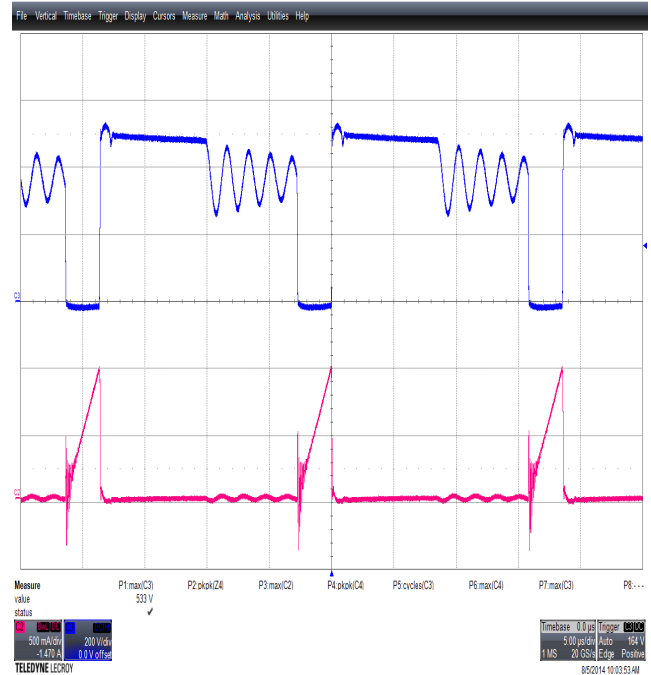
**Figure 12** – Infrared Thermograph of Open Frame Operation, at Room Temperature.  
265 VAC, 35 W Load, 28.4 °C Ambient.

# 11 Waveforms

## 11.1 Drain Voltage and Current, Normal Operation

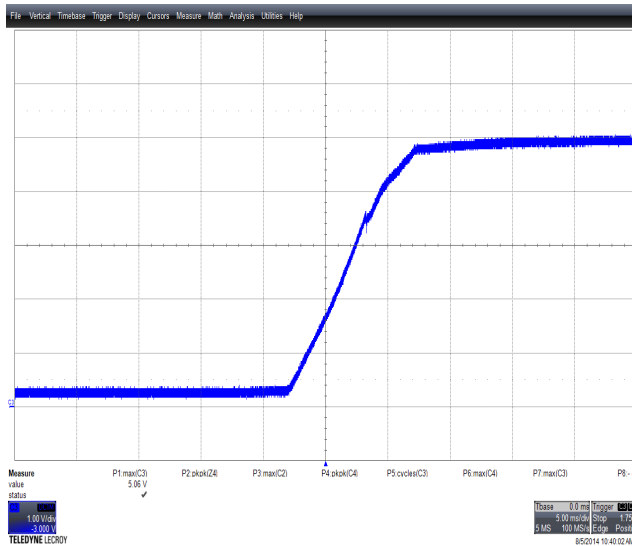


**Figure 13** – 90 VAC, Full Load.  
 Upper:  $V_{DRAIN}$ , 100 V, 5  $\mu$ s / div.  
 Lower:  $I_{DRAIN}$ , 0.5 A / div.

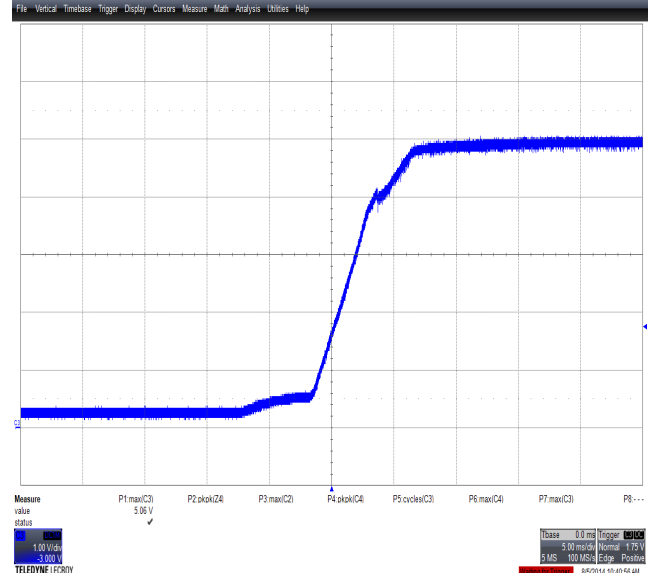


**Figure 14** – 265 VAC, Full Load.  
 Upper:  $V_{DRAIN}$ , 200 V, 5  $\mu$ s / div.  
 Lower:  $I_{DRAIN}$ , 0.5 A / div.

## 11.2 Output Voltage Start-up Profile

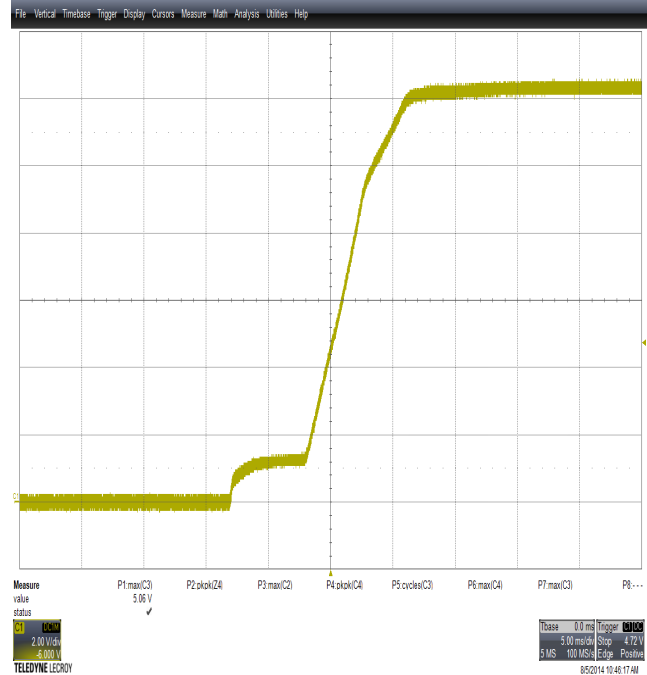
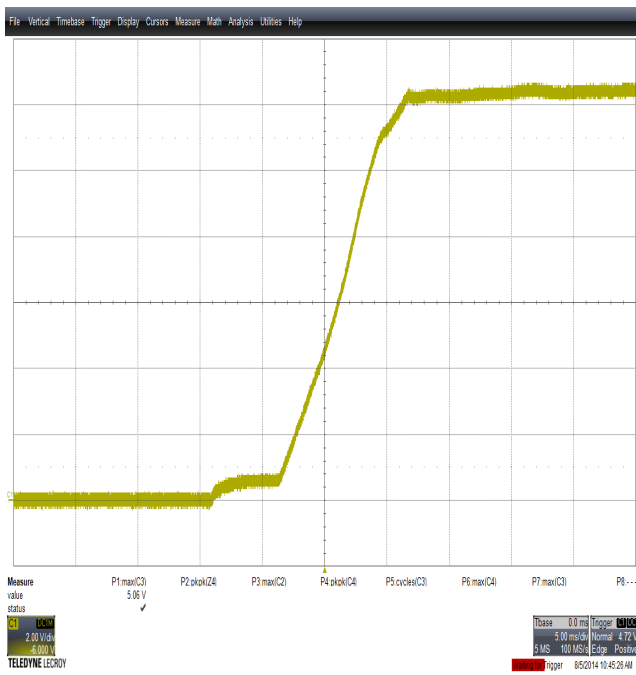


**Figure 15** – 5 V Start-up Profile, Full Load;  
 90 VAC; 1 V / div., 5 ms / div.



**Figure 16** – 5 V Start-up Profile, Full Load;  
 265 VAC; 1 V / div., 5 ms / div.



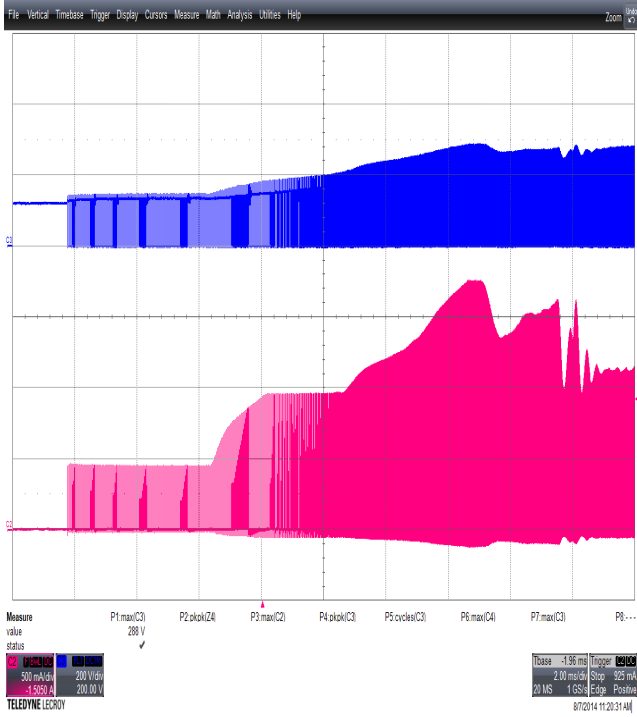


**Figure 17** – 12 V Start-up Profile, Full Load; 90 VAC; 2 V / div., 5 ms / div.

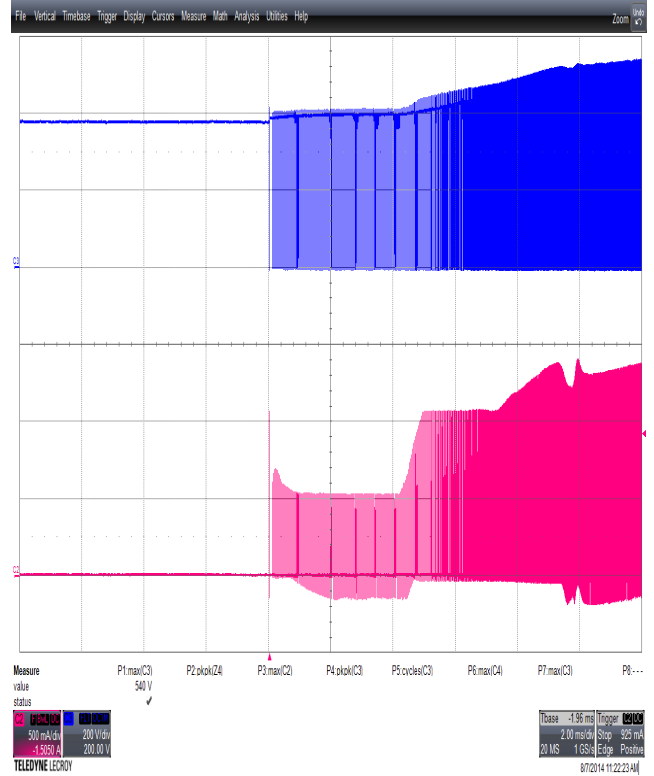
**Figure 18** – 12 V Start-up Profile, Full Load; 265 VAC; 2 V / div., 5 ms / div.



### 11.3 Drain Voltage and Current Start-up Profile



**Figure 19** – 90 VAC Input and Maximum Load.  
Upper:  $V_{DRAIN}$ , 200 V, 2 mS / div.  
Lower:  $I_{DRAIN}$ , 0.5 A / div.

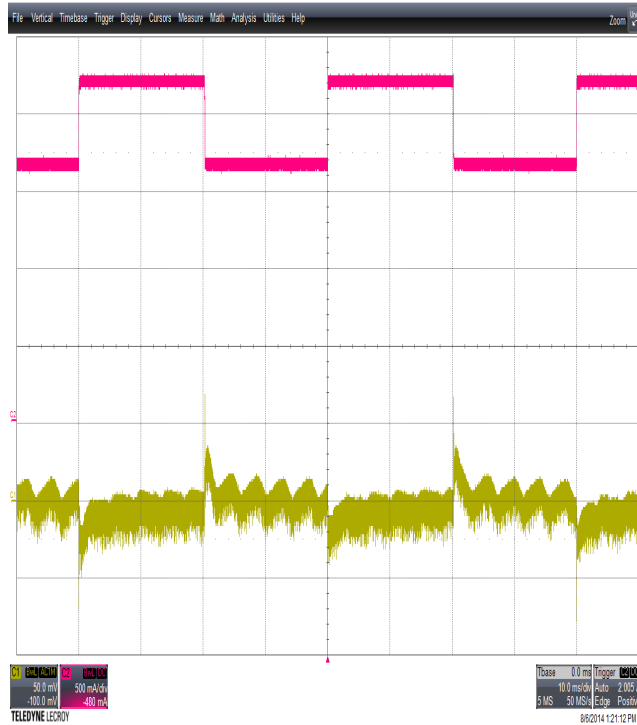
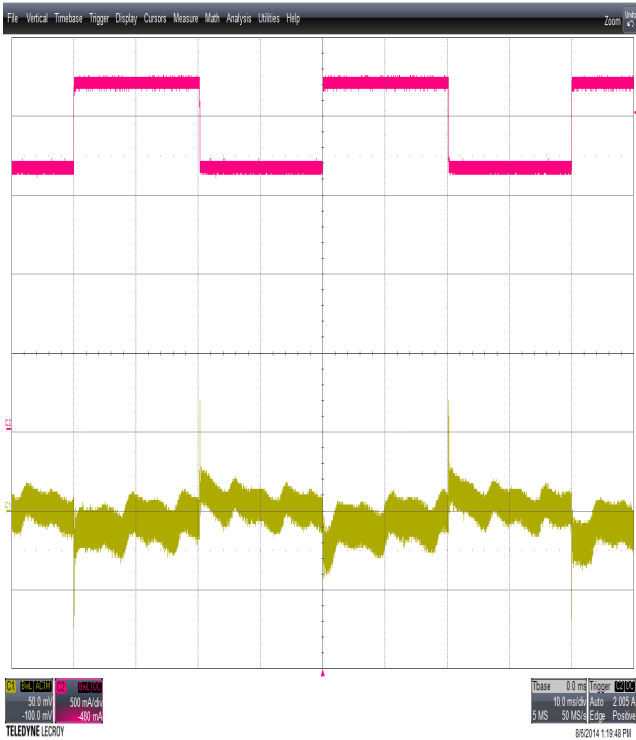


**Figure 20** – 265 VAC Input and Maximum Load.  
Upper:  $V_{DRAIN}$ , 200 V, 2 mS / div.  
Lower:  $I_{DRAIN}$ , 0.5 A / div.



### 11.4 Load Transient Response (75% to 100% Load Step)

In the figures shown below, signal averaging was used to better enable viewing of the load transient response. The oscilloscope was triggered using the load current step as a trigger source. Since the output switching and line frequency occur essentially at random with respect to the load transient, contributions to the output ripple from these sources will average out, leaving the contribution only from the load step response.



**Figure 21** – 5 V Transient Response, 90 VAC, 75-100-75% Load Step.  
Upper:  $I_{OUT}$  0.5 A / div, 10 ms / div.  
Lower:  $V_{OUT}$  50 mV / div.

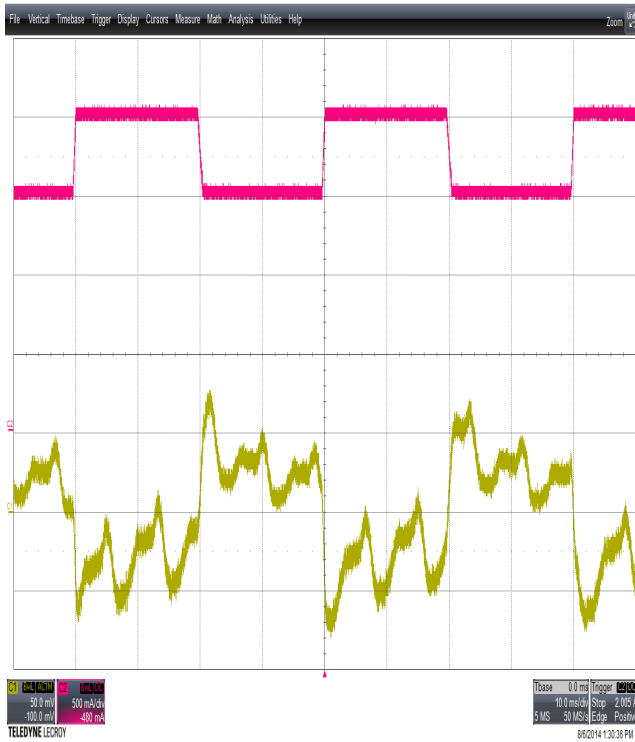
Note: 12 V Output maintained at full load.

**Figure 22** – 5 V Transient Response, 265 VAC, 75-100-75% Load Step.  
Upper:  $I_{OUT}$  0.5 A / div, 10 ms / div.  
Lower:  $V_{OUT}$  50 mV / div.

Note: 12 V Output maintained at full load.

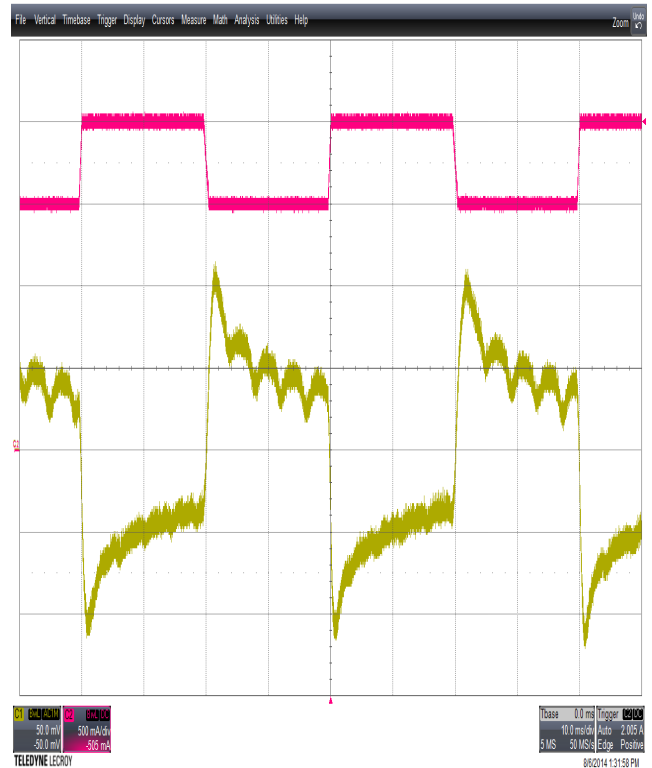






**Figure 23** – 12 V Output in Response to 5 V Transient, 90 VAC, 75-100-75% Load Step.  
Upper:  $I_{OUT}$  0.5 A / div., 10 ms / div.  
Lower:  $V_{OUT}$  50 mV / div.

Note: 5 V Output maintained at full load.  
(Waveshape is combination of line ripple and transient response - see Figure 26)



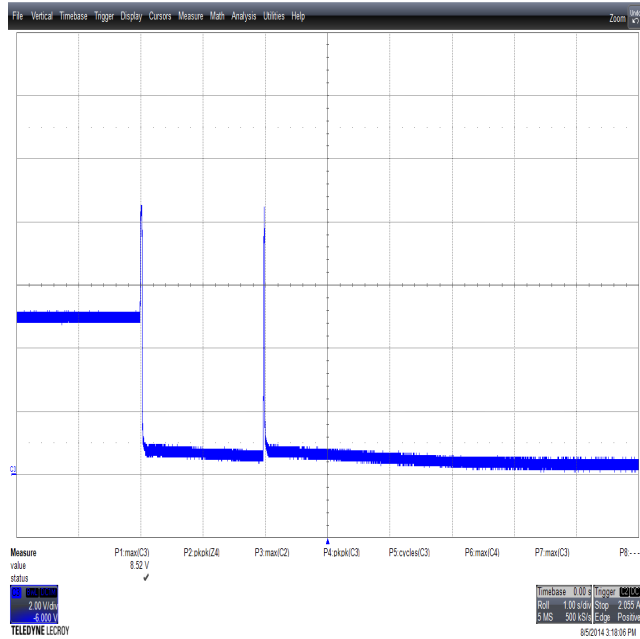
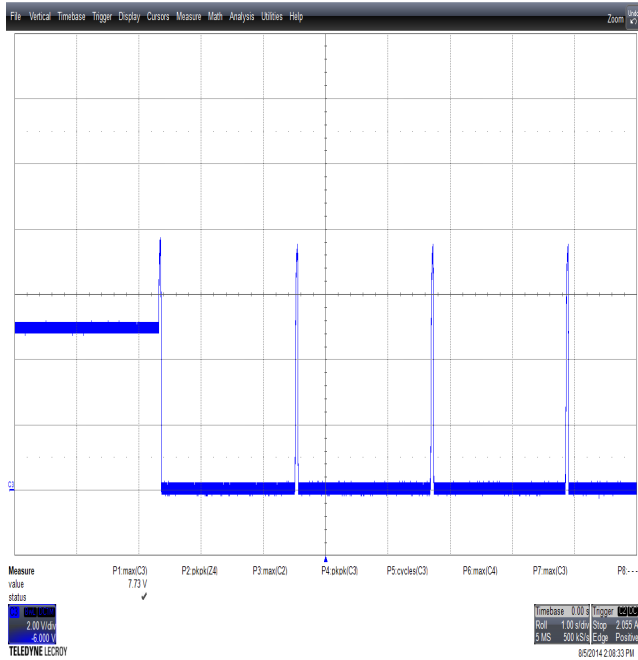
**Figure 24** – 12 V Output in Response to 5 V Transient, 265 VAC, 75-100-75% Load Step.  
Upper:  $I_{OUT}$  0.5 A / div., 10 ms / div.  
Lower:  $V_{OUT}$  20 mV / div.

Note: 5 V Output maintained at full load.



### 11.5 Output Overvoltage Protection

The figures below show the performance of the output overvoltage protection circuit when the control loop was opened.



**Figure 25** – 5 V Output in Response to Open Loop  
 $R5 = 5.1 \text{ k}\Omega$  to Configure Hysteretic Shutdown.  
 Output Voltage 2 V / div., 1 s / div.

**Figure 26** – 5 V Output in Response to Open Loop  
 $R5 = 20 \text{ }\Omega$  to Configure Latching Shutdown.  
 Output Voltage 2 V / div., 1 s / div.

Note: 12 V Output maintained at no load.

Note: 12 V Output maintained at no load.

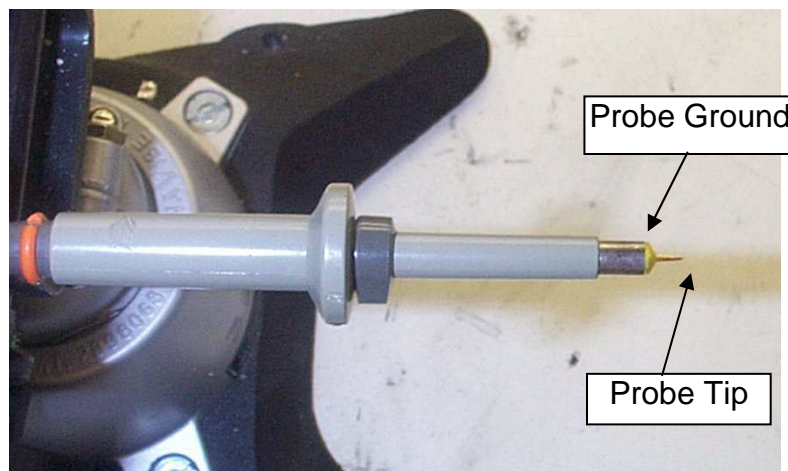


## 11.6 Output Ripple Measurements

### 11.6.1 Ripple Measurement Technique

For DC output ripple measurements, a modified oscilloscope test probe must be utilized in order to reduce spurious signals due to pick-up. Details of the probe modification are provided below.

The 4987BA probe adapter is affixed with two capacitors tied in parallel across the probe tip. The capacitors include one (1) 0.1  $\mu\text{F}/50\text{ V}$  ceramic type and one (1) 1.0  $\mu\text{F}/50\text{ V}$  aluminum electrolytic. The aluminum electrolytic type capacitor is polarized, so proper polarity across DC outputs must be maintained (see below).

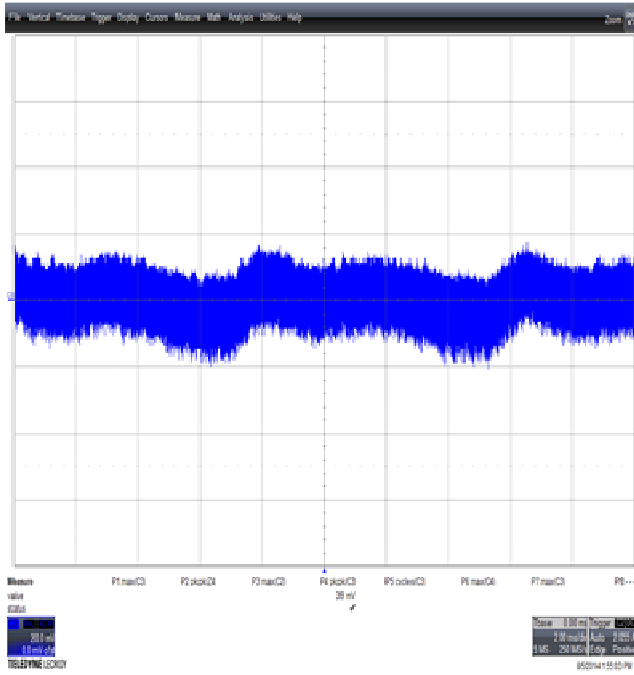


**Figure 23** – Oscilloscope Probe Prepared for Ripple Measurement. (End Cap and Ground Lead Removed)

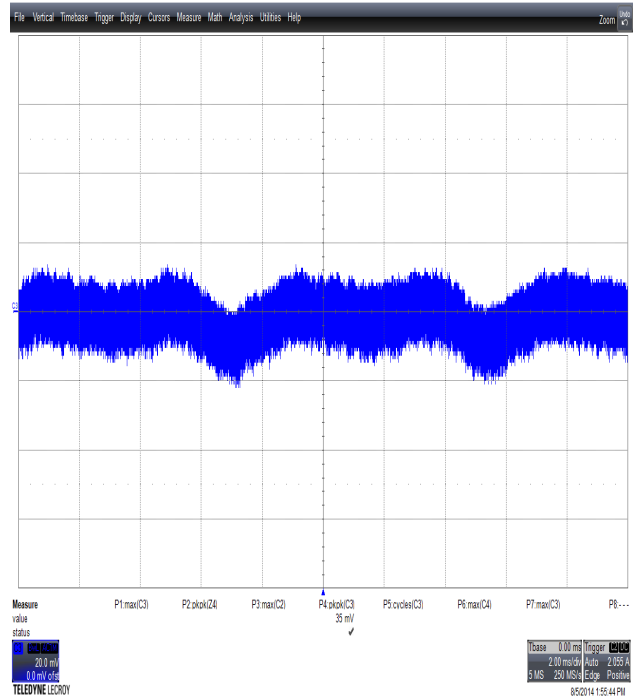


**Figure 24** – Oscilloscope Probe with Probe Master ([www.probemaster.com](http://www.probemaster.com)) 4987A BNC Adapter. (Modified with wires for ripple measurement, and two parallel decoupling capacitors added)

### 11.6.2 Measurement Results

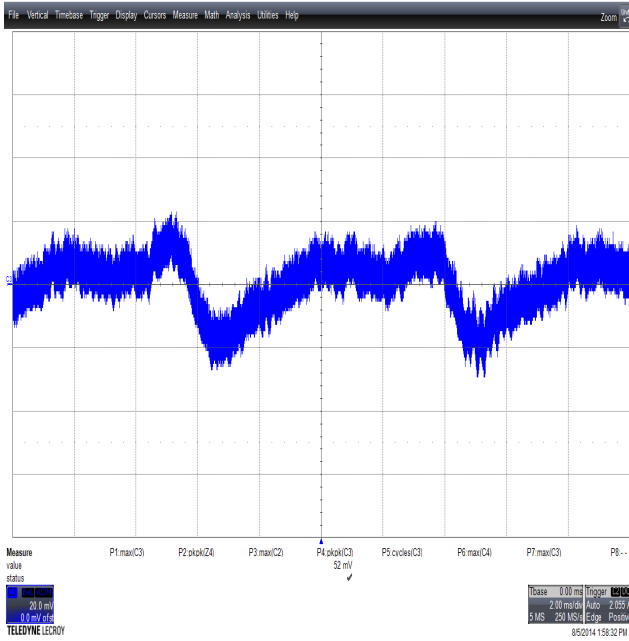


**Figure 27** – 5 V Ripple, 90 VAC, Full Load.  
2 ms, 20 mV / div.

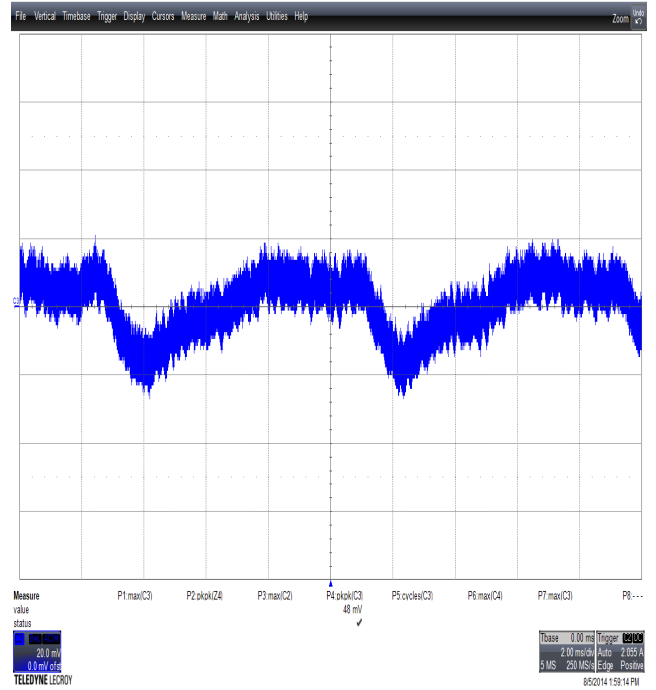


**Figure 28** – 5 V Ripple, 115 VAC, Full Load.  
2 ms, 20 mV / div.





**Figure 29** – 12 V Ripple, 90 VAC, Full Load.  
2 ms, 20 mV /div.



**Figure 30**– 12 V Ripple, 115 VAC, Full Load.  
2 ms, 20 mV /div.

## 12 Line Surge

Differential input line 1.2/50  $\mu$ s surge testing was completed on a single test unit to IEC61000-4-5. Input voltage was set at 230 VAC / 60 Hz. Output was loaded at full load and operation was verified following each surge event.

Surge Level (V)	Input Voltage (VAC)	Injection Location	Injection Phase (°)	Test Result (Pass/Fail)
+500	230	L to N	90	Pass
-500	230	L to N	270	Pass
+1000	230	L to N	90	Pass
-1000	230	L to N	270	Pass
+2000	230	L,N to G	90	Pass
-2000	230	L,N to G	270	Pass

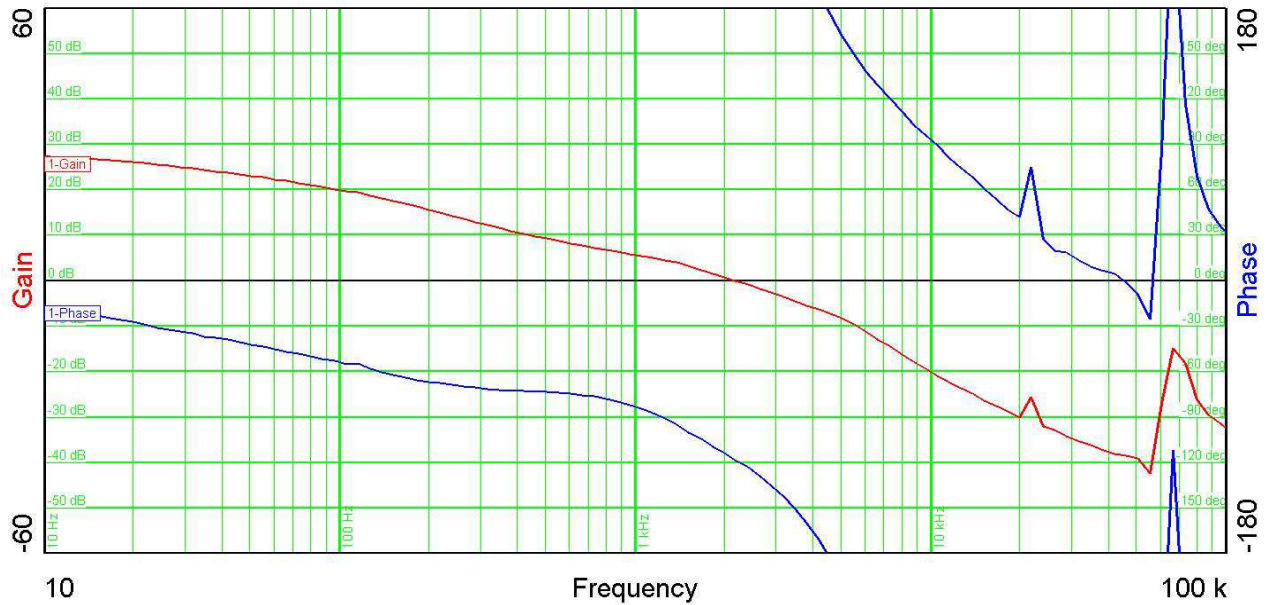
Note: Unit passes under all test conditions.

Use a Slow Blow fuse at the input (F1) to increase differential surge withstand to 2 kV.



## 13 Control Loop Measurements

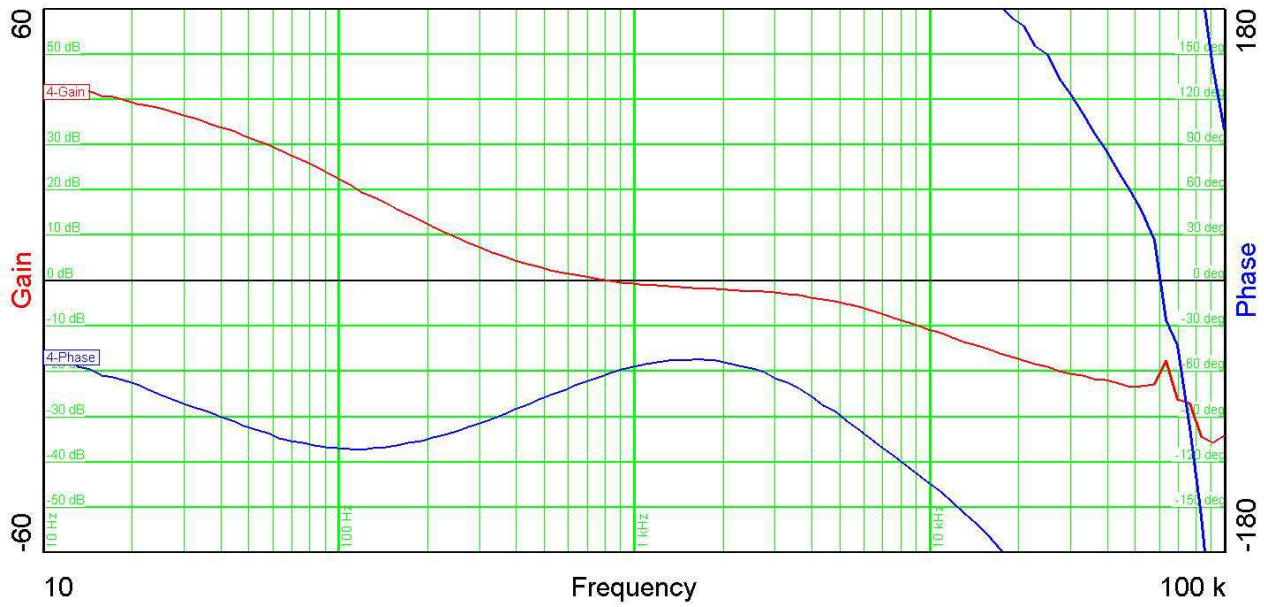
### 13.1 90 VAC Maximum Load



**Figure 31** – Gain-Phase Plot, 90 VAC, Maximum Steady-State Load.  
 Vertical Scale: Gain = 10 dB / div., Phase = 30 °/div.  
 Crossover Frequency = 2.5 kHz Phase Margin = 65°.



**13.2 265 VAC Maximum Load**



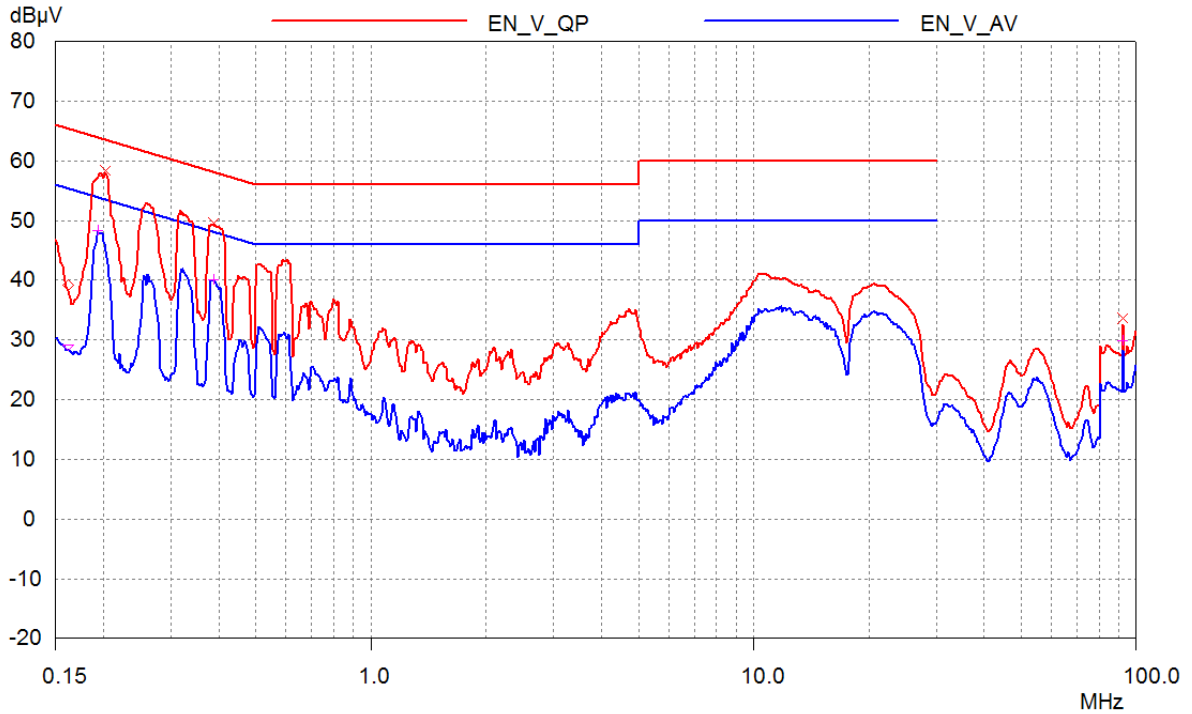
**Figure 32** – Gain-Phase Plot, 265 VAC, Maximum Steady-State Load.  
Vertical Scale: Gain = 10 dB / div., Phase = 30 °/div.  
Crossover Frequency = 350 Hz, Phase Margin = 90°.





### 14 Conducted EMI

Conducted EMI measurements were made with the output connected to the earth ground connection on the LISN. The result below represents the worst case results.



**Figure 33** – Conducted EMI, Neutral Conductor, Maximum Steady-State Load, 230 VAC, 60 Hz, and EN55022 B Limits.

## 15 Revision History

Date	Author	Revision	Description & changes	Reviewed
24-Sep-07	SGK	1.0	Initial Release	
24-Sep-07	KM	1.1	Corrected Ice Components part number	
07-Dec-07	SGK	1.2	Updated transformer materials list	
07-Aug-14	SK	1.3	Evaluation of RDK with 0 Ohm Bias Resistor-Changed R10 from 4.7 Ohm to Zero Ohm	



## For the latest updates, visit our website: [www.powerint.com](http://www.powerint.com)

Power Integrations reserves the right to make changes to its products at any time to improve reliability or manufacturability. Power Integrations does not assume any liability arising from the use of any device or circuit described herein. POWER INTEGRATIONS MAKES NO WARRANTY HEREIN AND SPECIFICALLY DISCLAIMS ALL WARRANTIES INCLUDING, WITHOUT LIMITATION, THE IMPLIED WARRANTIES OF MERCHANTABILITY, FITNESS FOR A PARTICULAR PURPOSE, AND NON-INFRINGEMENT OF THIRD PARTY RIGHTS.

### PATENT INFORMATION

The products and applications illustrated herein (including transformer construction and circuits' external to the products) may be covered by one or more U.S. and foreign patents, or potentially by pending U.S. and foreign patent applications assigned to Power Integrations. A complete list of Power Integrations' patents may be found at [www.powerint.com](http://www.powerint.com). Power Integrations grants its customers a license under certain patent rights as set forth at <http://www.powerint.com/ip.htm>.

The PI Logo, TOPSwitch, TinySwitch, LinkSwitch, LYTSwitch, DPA-Switch, PeakSwitch, CAPZero, SENZero, LinkZero, HiperPFS, HiperTFS, HiperLCS, Qspeed, EcoSmart, Clampless, E-Shield, Filterfuse, StackFET, PI Expert and PI FACTS are trademarks of Power Integrations, Inc. Other trademarks are property of their respective companies. ©Copyright 2013 Power Integrations, Inc.

## Power Integrations Worldwide Sales Support Locations

### WORLD HEADQUARTERS

5245 Hellyer Avenue  
San Jose, CA 95138, USA.  
Main: +1-408-414-9200  
Customer Service:  
Phone: +1-408-414-9665  
Fax: +1-408-414-9765  
*e-mail: [usasales@powerint.com](mailto:usasales@powerint.com)*

### GERMANY

Lindwurmstrasse 114  
80337, Munich  
Germany  
Phone: +49-895-527-39110  
Fax: +49-895-527-39200  
*e-mail: [eurosales@powerint.com](mailto:eurosales@powerint.com)*

### JAPAN

Kosei Dai-3 Building  
2-12-11, Shin-Yokohama,  
Kohoku-ku, Yokohama-shi,  
Kanagawa 222-0033  
Japan  
Phone: +81-45-471-1021  
Fax: +81-45-471-3717  
*e-mail: [japansales@powerint.com](mailto:japansales@powerint.com)*

### TAIWAN

5F, No. 318, Nei Hu Rd.,  
Sec. 1  
Nei Hu District  
Taipei 11493, Taiwan R.O.C.  
Phone: +886-2-2659-4570  
Fax: +886-2-2659-4550  
*e-mail: [taiwansales@powerint.com](mailto:taiwansales@powerint.com)*

### CHINA (SHANGHAI)

Rm 2410, Charity Plaza, No. 88,  
North Caoxi Road,  
Shanghai, PRC 200030  
Phone: +86-21-6354-6323  
Fax: +86-21-6354-6325  
*e-mail: [chinasales@powerint.com](mailto:chinasales@powerint.com)*

### INDIA

#1, 14<sup>th</sup> Main Road  
Vasanthanagar  
Bangalore-560052  
India  
Phone: +91-80-4113-8020  
Fax: +91-80-4113-8023  
*e-mail: [indiasales@powerint.com](mailto:indiasales@powerint.com)*

### KOREA

RM 602, 6FL  
Korea City Air Terminal B/D,  
159-6  
Samsung-Dong, Kangnam-Gu,  
Seoul, 135-728 Korea  
Phone: +82-2-2016-6610  
Fax: +82-2-2016-6630  
*e-mail: [koreasales@powerint.com](mailto:koreasales@powerint.com)*

### EUROPE HQ

1st Floor, St. James's House  
East Street, Farnham  
Surrey GU9 7TJ  
United Kingdom  
Phone: +44 (0) 1252-730-141  
Fax: +44 (0) 1252-727-689  
*e-mail: [eurosales@powerint.com](mailto:eurosales@powerint.com)*

### CHINA (SHENZHEN)

3rd Floor, Block A,  
Zhongtuo International Business  
Center, No. 1061, Xiang Mei Rd,  
FuTian District, ShenZhen,  
China, 518040  
Phone: +86-755-8379-3243  
Fax: +86-755-8379-5828  
*e-mail: [chinasales@powerint.com](mailto:chinasales@powerint.com)*

### ITALY

Via Milanese 20, 3<sup>rd</sup> Fl.  
20099 Sesto San Giovanni  
(MI) Italy  
Phone: +39-024-550-8701  
Fax: +39-028-928-6009  
*e-mail: [eurosales@powerint.com](mailto:eurosales@powerint.com)*

### SINGAPORE

51 Newton Road,  
#19-01/05 Goldhill Plaza  
Singapore, 308900  
Phone: +65-6358-2160  
Fax: +65-6358-2015  
*e-mail: [singaporesales@powerint.com](mailto:singaporesales@powerint.com)*

### APPLICATIONS HOTLINE

World Wide +1-408-414-9660

### APPLICATIONS FAX

World Wide +1-408-414-9760



## X-ON Electronics

Largest Supplier of Electrical and Electronic Components

*Click to view similar products for [Power Management IC Development Tools](#) category:*

*Click to view products by [Power Integrations](#) manufacturer:*

Other Similar products are found below :

[EVAL6482H-DISC](#) [EVAL-AD5522EBUZ](#) [EVAL-ADM1060EBZ](#) [EVAL-ADM1073MEBZ](#) [EVAL-ADM1166TQEBZ](#) [EVAL-ADM1168LQEBZ](#) [EVAL-ADM1171EBZ](#) [EVAL-ADM1276EBZ](#) [EVB-EN5319QI](#) [EVB-EN5365QI](#) [EVB-EN6347QI](#) [EVB-EP5348UI](#) [MIC23158YML EV](#) [MIC23451-AAAYFL EV](#) [MIC5281YMME EV](#) [124352-HMC860LP3E](#) [ADM00513](#) [ADM8611-EVALZ](#) [ADM8612-EVALZ](#) [ADM8613-EVALZ](#) [ADP1046ADC1-EVALZ](#) [ADP1055-EVALZ](#) [ADP122-3.3-EVALZ](#) [ADP130-0.8-EVALZ](#) [ADP130-1.2-EVALZ](#) [ADP130-1.5-EVALZ](#) [ADP130-1.8-EVALZ](#) [ADP160UJZ-REDYKIT](#) [ADP166UJ-EVALZ](#) [ADP1712-3.3-EVALZ](#) [ADP1714-3.3-EVALZ](#) [ADP1715-3.3-EVALZ](#) [ADP1716-2.5-EVALZ](#) [ADP1740-1.5-EVALZ](#) [ADP1752-1.5-EVALZ](#) [ADP1754-1.5-EVALZ](#) [ADP1828LC-EVALZ](#) [ADP1870-0.3-EVALZ](#) [ADP1871-0.6-EVALZ](#) [ADP1873-0.6-EVALZ](#) [ADP1874-0.3-EVALZ](#) [ADP1876-EVALZ](#) [ADP1879-1.0-EVALZ](#) [ADP1882-1.0-EVALZ](#) [ADP1883-0.6-EVALZ](#) [ADP197CB-EVALZ](#) [ADP199CB-EVALZ](#) [ADP2102-1.25-EVALZ](#) [ADP2102-1.2-EVALZ](#) [ADP2102-1.875EVALZ](#)