



Title	<i>Reference Design Report for a 6 W Non-Dimmable, Non-Isolated Buck LED Driver Using LYTSwitch™-0 LYT0006P</i>
Specification	90 VAC – 265 VAC Input; 54 V, 110 mA Output
Application	GU10 LED Driver Lamp Replacement
Author	Applications Engineering Department
Document Number	RDR-355
Date	June 18, 2013
Revision	1.0

Summary and Features

- Single-stage power factor corrected (>0.75 at 120 V and >0.5 at 230 V) and accurate constant current (CC) output
- Low cost, low component count and small PCB footprint solution
- Highly energy efficient, >91 % at 120 VAC input
- Highly energy efficient, >90 % at 240 VAC input
- Superior performance and end user experience
 - Fast start-up time (<20 ms) – no perceptible delay
- Integrated protection and reliability features
 - Single shot no-load protection / output short-circuit protected with auto-recovery
 - Auto-recovering thermal shutdown with large hysteresis protects both components and PCB
 - No damage during brown-out conditions
- Meets IEC ring wave, differential line surge and EN55015 conducted EMI

PATENT INFORMATION

The products and applications illustrated herein (including transformer construction and circuits external to the products) may be covered by one or more U.S. and foreign patents, or potentially by pending U.S. and foreign patent applications assigned to Power Integrations. A complete list of Power Integrations' patents may be found at www.powerint.com. Power Integrations grants its customers a license under certain patent rights as set forth at <http://www.powerint.com/ip.htm>.

Table of Contents

1	Introduction.....	4
2	Power Supply Specification	6
3	Schematic.....	7
4	Circuit Description	8
4.1	Input EMI Filtering	8
4.2	LYTSwitch-0	8
4.3	Output Rectification	8
4.4	Output Feedback.....	8
4.5	No-Load Protection	9
5	PCB Layout	10
6	Bill of Materials	12
7	Inductor Specification	13
7.1	Electrical Diagram	13
7.2	Electrical Specifications.....	13
7.3	Materials.....	13
7.4	Inductor Build Diagram.....	14
7.5	Transformer Construction.....	14
8	Inductor Design Spreadsheet.....	15
9	Performance Data	17
9.1	Active Mode Efficiency	18
9.2	Output Current Regulation.....	19
9.2.1	Input Line and Load Voltage to Output Current Regulation.....	19
10	Thermal Performance	20
10.1	Equipment Used.....	20
11	Thermal Result.....	21
11.1	Thermal Scan	22
12	Waveforms.....	23
12.1	Drain Voltage Normal Operation	23
12.2	Drain Current at Normal Operation.....	24
12.3	Drain Voltage and Current When Output Short	26
12.4	Drain Voltage and Current Start-up Profile	26
12.5	Output Current Start-up Profile.....	27
12.6	Input-Output Profile	28
12.7	Line Sag and Surge.....	29
12.8	Brown-out/ Brown-in	30
13	Line Surge.....	31
14	Conducted EMI	33
15	Audible Noise.....	35
16	Appendix.....	36
17	Revision History.....	39



Important Note:

Although this board is designed to satisfy safety isolation requirements, the engineering prototype has not been agency approved. Therefore, all testing should be performed using an isolation transformer to provide the AC input to the prototype board.



1 Introduction

This document describes a cost effective power supply utilizing the LYTSwitch™-0 family (LYT0006P) in a highly compact buck topology.

This power supply operates over an input voltage range of 90 VAC to 264 VAC. The DC bus voltage is high enough to support a 54 V output when using a buck topology. In a buck converter the output voltage must always be lower than the input voltage. The output voltage is also limited by the maximum duty cycle of the LYTSwitch-0, which also requires the input voltage to be larger than the output voltage.

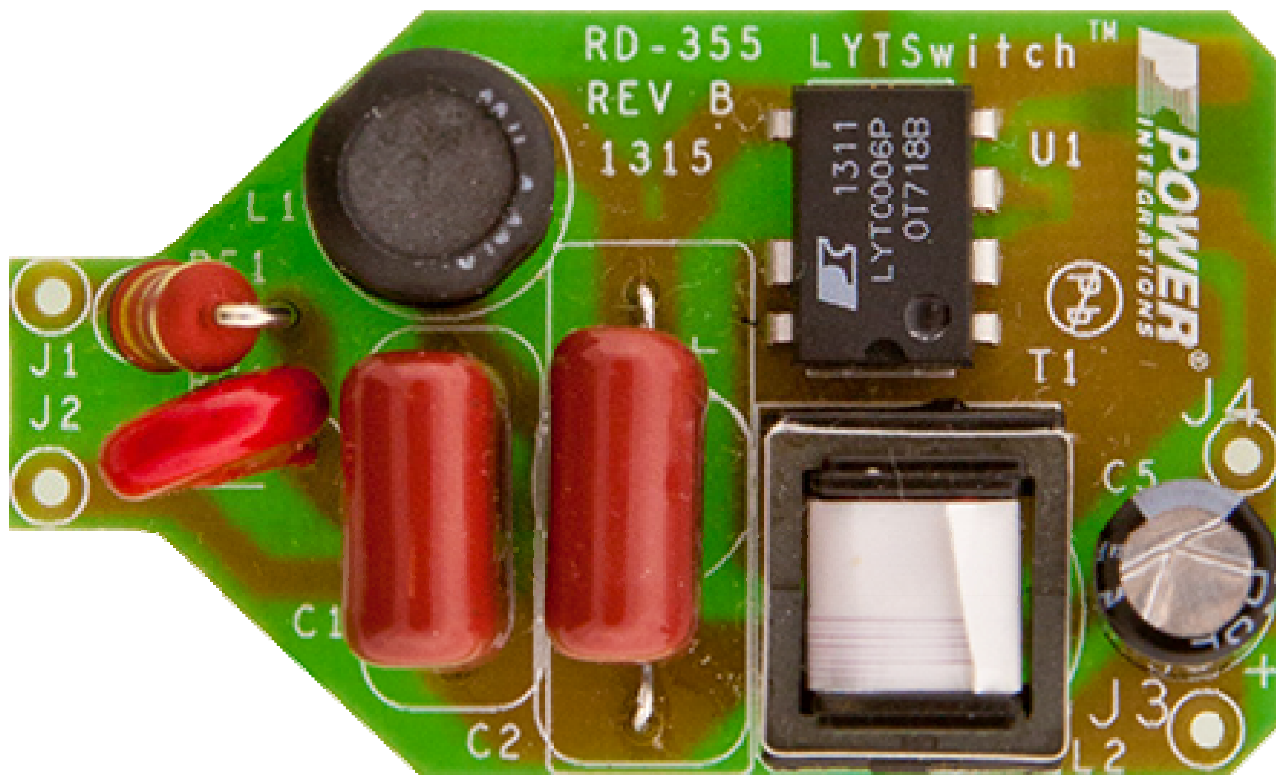

Figure 1 – Populated Circuit Board Photograph, Top.



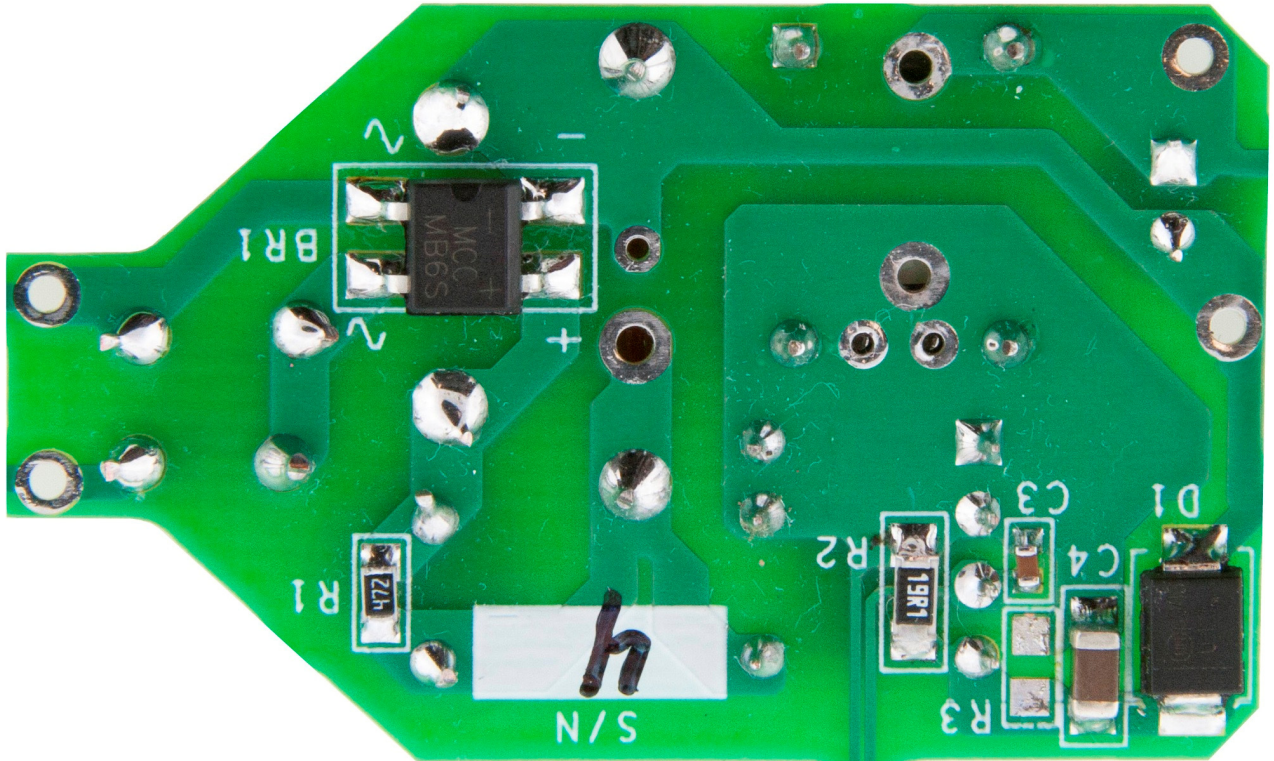

Figure 2 – Populated Circuit Board Photograph, Bottom.



2 Power Supply Specification

Description	Symbol	Min	Typ	Max	Units	Comment
Input Voltage Operation	V_{IN}	90		265	VAC	2 Wire – no P.E. Operating frequency is not limited. Adjust sense resistor if application is for 400 Hz line.
Frequency	f_{LINE}	47	50/60		Hz	
Output Output Voltage	V_{OUT}	52	54	56	V	±4% at 100 VAC - 240 VAC
Output Current	I_{OUT}		110		mA	
Total Output Power Continuous Output Power	P_{OUT}		6	6.5	W	
Efficiency 120 VAC; 54 V LED	η	91			%	Measured at P_{OUT} 25 °C
240 VAC; 54 V LED	η	90			%	
Power Factor 120 VAC; 54 V LED	PF	0.75				Measured at P_{OUT} 25 °C
240 VAC; 54 V LED	PF	0.5				
Environmental Conducted EMI		Meets CISPR22B / EN55015B				1.2/50 μ s surge, IEC 1000-4-5, Series Impedance: Differential Mode: 2 Ω 500 A short circuit Series Impedance: Differential Mode: 2 Ω
Line Surge Differential Mode (L1-L2)			0.5		kV	
Ring Wave (100 kHz) Differential Mode (L1-L2)			2.5		kV	
Ambient Temperature	T_{AMB}	-10	25		°C	Free convection, sea level UUT can start-up at – (neg) 40 °C



3 Schematic

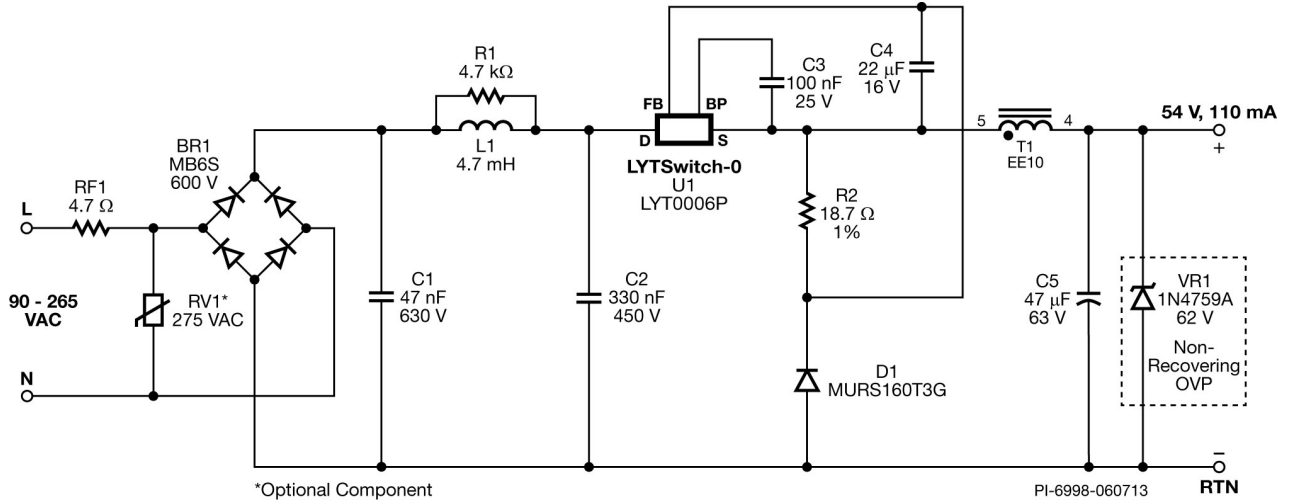

Figure 3 – Schematic. T1 can be replaced by a drum core inductor if final casing/housing has sufficient room to avoid shorting the magnetic flux. Zener diode VR1 is an option and provides one-time no-load protection.



4 Circuit Description

The power supply shown in Figure 3 uses the LYT0006P (U1) in a high-side buck configuration to deliver a constant 110 mA current at an output voltage of 54 VDC. The power supply is designed for driving LEDs, which should always be driven with a constant current (CC).

4.1 Input EMI Filtering

Fuse RF1 provides short circuit protection. Bridge BR1 provides full wave rectification for good power factor. Capacitor C1, C2 and common-mode choke L1 form a π filter in order meet conducted EMI standards. Capacitor C1 and C2 are also used for energy storage reducing line noise and protecting against line surge.

4.2 LYTSwitch-0

LYTSwitch-0 is optimized to achieve a simple and cost effective LED driver with good line and temperature regulation from 0 to 100°C (LYTSwitch-0 case temperature). The PIXIs spreadsheet was used to achieve the best line regulation by balancing the power inductor and the sense resistor. The total input capacitance will also have some effect but it can be compensated for by adjusting the sense resistor (R2/R3) to optimize performance.

The LYTSwitch-0 family has built-in thermal limit to protect the power supply in case the bulb is subjected to an excessive operating temperature.

The buck converter stage is consists of the integrated power MOSFET switch within LYT0006P (U1), a freewheeling diode (D1), sense resistor (R2), power inductor L2 and output capacitor (C5). The converter is operating mostly in DCM in order to limit the cycles of reverse current. A fast freewheeling diode was selected to minimize the switching losses.

Inductor L2 is a standard EE10 which will constrain the flux path and ensure the right inductance in any casing. It can be replaced by a lower cost drum-core inductor once positioned in a specific enclosure that has a known effect on the magnetic flux of the inductor.

4.3 Output Rectification

Fast output diode (D1) was used to achieve good efficiency and for thermal management. Normally for LED applications, the ambient temperature is above 70°C. A device with low t_{RR} (<35 nS) is recommended.

4.4 Output Feedback

Regulation is maintained by skipping switching cycles. As the output current rises, the voltage into the FB pin will rise. If this exceeds V_{FB} then subsequent cycles will be skipped until the voltage reduces below V_{FB} . Current is sensed from R2 and filtered by



C4, then fed to the FB pin for accurate regulation. The key to achieving good line regulation is in balancing the power inductor and sense resistor values after the minimum inductance has been calculated.

The bypass capacitor (C4) is connected between the FEEDBACK pin and the SOURCE pin and helps reduce power loss during output current sensing. The capacitor acts to sample-and-hold the feedback current information for the FB pin. No limiting resistor is required between the FB pin and C4, because the peak voltage will not exceed the maximum rating of the device.

4.5 No-Load Protection

Optional, one shot, no-load protection circuit is incorporated in this design. In case of accidental no-load operation, the output capacitor is protected by VR1. Zener diode VR1 would need to be replaced after a failure.

In operation (LED retrofit lamp), the load is always connected, so VR1 can be removed to save cost. To protect during board level testing (in manufacturing) 40 VAC can be applied to the input; if no output current is measured then the load is not connected. This test will allow safe, non-destructive initial power up of the board, without the need of an OV protection circuit.



5 PCB Layout

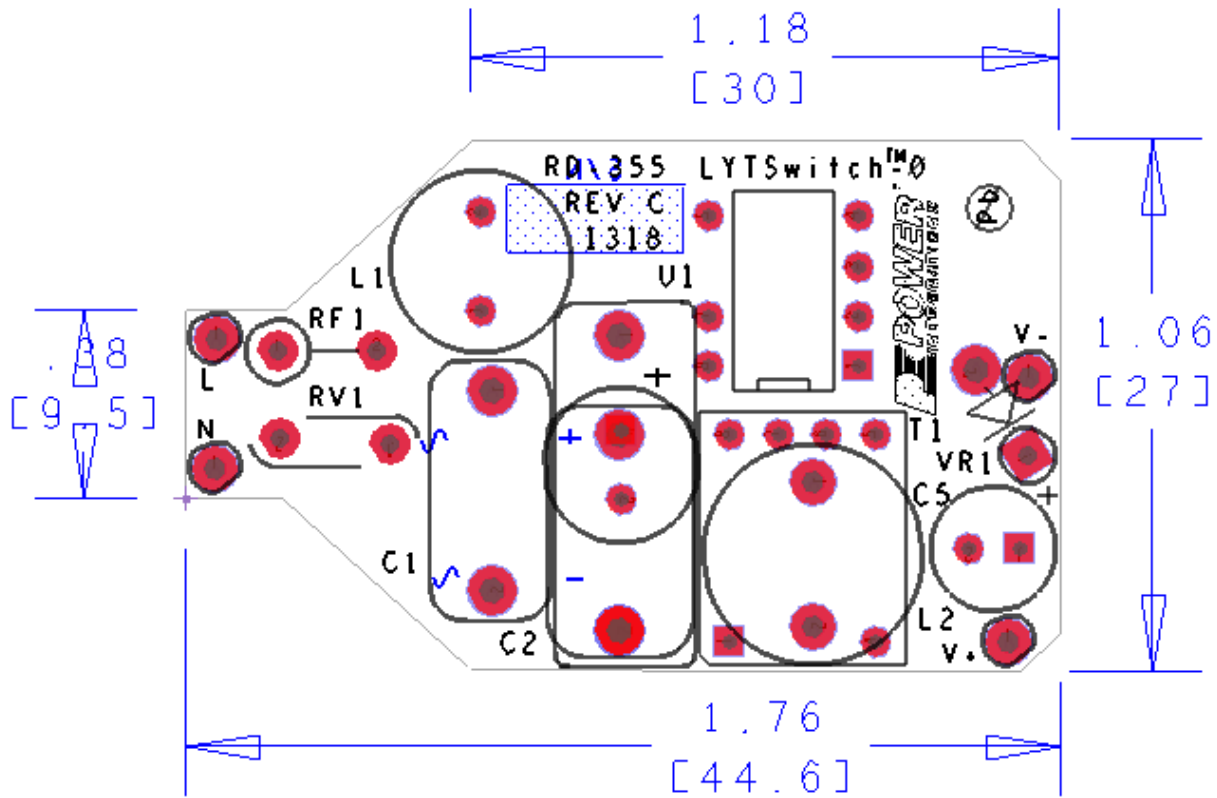

Figure 4 – Printed Circuit Layout. Top view.



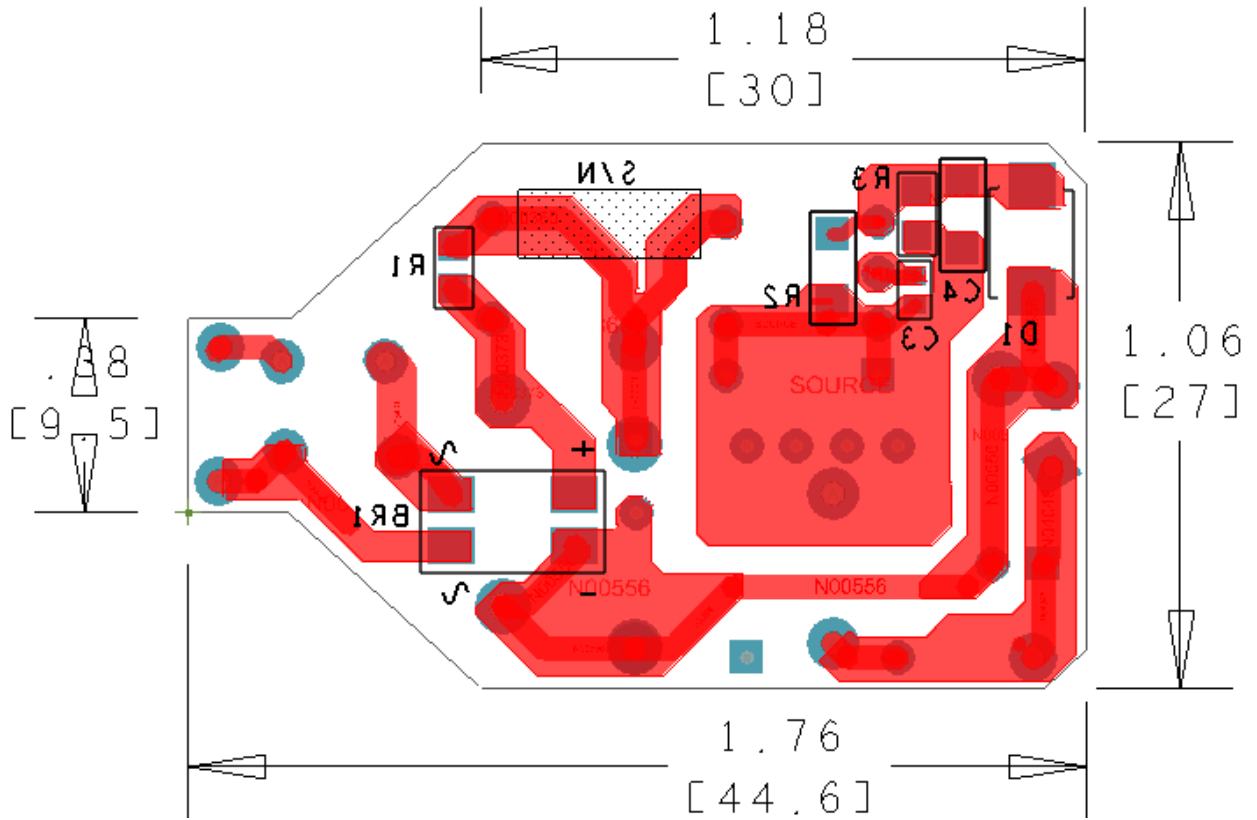

Figure 5 – Printed Circuit Layout. Bottom View.



6 Bill of Materials

Item	Qty	Ref Des	Description	Manufacturer P/N	Manufacturer
1	1	BR1	600 V, 0.5 A, Bridge Rectifier, SMD, MBS-1, 4-SOIC	MB6S-TP	Micro Commercial
2	1	C1	47 nF, 630 V, Film	ECQ-E6473KF	Panasonic
3	1	C2	330 nF, 450 V, METALPOLYPRO	ECW-F2W334JAQ	Panasonic
4	1	C3	100 nF, 25 V, Ceramic, X7R, 0603	VJ0603Y104KNXAO	Vishay
5	1	C4	22 μ F, 16 V, Ceramic, X5R, 1206	EMK316BJ226ML-T	Taiyo Yuden
6	1	C5	47 μ F, 63 V, Electrolytic, Gen. Purpose, (6.3 x 13)	63YXJ47M6.3X11	Rubycon
7	1	D1	600 V, 1 A, Ultrafast Recovery, 35 ns, SMB Case	MURS160T3G	On Semi
8	1	L1	4.7 mH, 0.150 A, 20%	RL-5480-3-4700	Renco
9	1	R1	4.7 k Ω , 5%, 1/8 W, Thick Film, 0805	ERJ-6GEYJ472V	Panasonic
10	1	R2	18.7 Ω , 1%, 1/4 W, Thick Film, 1206	ERJ-8ENF18R7V	Panasonic
11	1	RF1	4.7 Ω , 5%, 2 W, Metal Film Fusible	FW20A4R70JA	Bourns
12	1	RV1	275 V, 23 J, 7 mm, RADIAL	V275LA4P	Littlefuse
13	1	T1	EE10, Bobbin Inductor	Custom SNX-R1699	Kunshan Fengshunhe Santronics USA
14	1	U1	LinkSwitch-0, DIP-8B	LYT0006P	Power Integrations
15	1	VR1	62 V, 5%, 1 W, DO-41	1N4759A	Vishay



7 Inductor Specification

7.1 Electrical Diagram

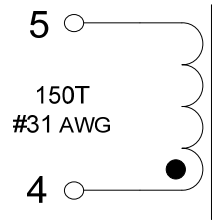

Figure 6 – Inductor Electrical Diagram.

7.2 Electrical Specifications

Primary Inductance	Pins 4-5, all other windings open, measured at 100 kHz, 0.4 V _{RMS} .	1.4 mH ±7%
---------------------------	--	------------

7.3 Materials

Item	Description
[1]	Core: EE10; TDK-PC40EE10/11-Z; or equivalent.
[2]	Bobbin: EE10; 8 pins (4/4), Horizontal, Pl#: 25-00956-00.
[3]	Magnet Wire: #31 AWG, double coated.
[4]	Tape: Polyester film, 3M 1350-1, 6.5mm wide.
[5]	Varnish.



7.4 Inductor Build Diagram

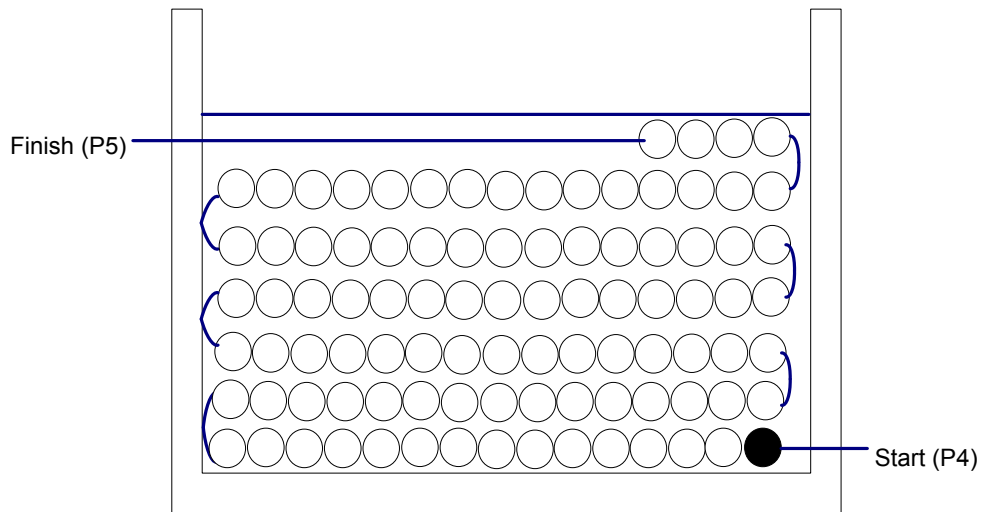

Figure 7 – Inductor Build Diagram.

7.5 Transformer Construction

Winding Preparation	Place bobbin item [2] on the mandrel with pin side 1-4 on the right side. Winding direction is clockwise direction.
Winding	Start pin 4, wind 150 turns of wire item [3] from right to left then left to right in ~6 layers and finish at pin 5.
Tape	Secure winding with tape item [4].
Final Assembly	Gap cores to get the 1.35 mH inductance. Apply tape to secure both cores.

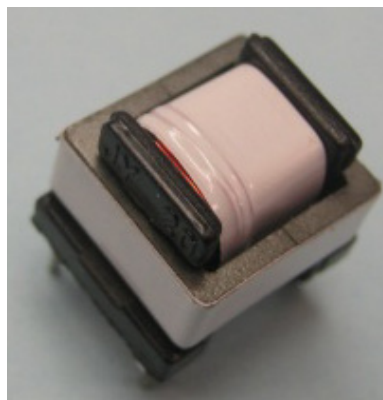

Figure 8 – Transformer Assembly Sample.



8 Inductor Design Spreadsheet

ACDC_LYTSwitchZero_052813; Rev.0.8; Copyright Power Integrations 2013	INPUT	INFO	OUTPUT	UNIT	LYTSwitchZero_Rev_0-8.xls: LYTSwitchZero Design Spreadsheet
INPUT VARIABLES					
VACMIN	90		90	Volts	Minimum AC Input Voltage
VACNOM	120		120		
VACMAX	265		265	Volts	Maximum AC Input Voltage
FL	60		60	Hertz	Line Frequency
VO	54		54	Volts	Output Voltage
IO	110		110	mA	Output Current
Pout			5.94	W	
EFFICIENCY	0.9		0.9		Overall Efficiency Estimate (Adjust to match Calculated, or enter Measured Efficiency)
CIN	0.38		0.38	uF	Input Filter Capacitor
Input Stage Resistance	4.7		4.7	ohms	Input Stage Resistance, Fuse & Filtering
Switching Topology			Buck		Type of Switching topology
DC INPUT VARIABLES					
VMIN			54.00068302	Volts	Minimum DC Bus Voltage
VMAX			374.766594	Volts	
LYTSwitchZero					
LYTSwitchZero	LYT0006		LYT0006		
ILIMIT			0.375	Amps	Typical Current Limit
ILIMIT_MIN			0.33275	Amps	Minimum Current Limit
ILIMIT_MAX			0.401	Amps	Maximum Current Limit
FSMIN			62000	Hertz	Minimum Switching Frequency
VDS			4.8375	Volts	Maximum On-State Drain To Source Voltage drop
DIODE					
VD			0.7	Volts	Freewheeling Diode Forward Voltage Drop
VRR			600	Volts	Recommended PIV rating of Freewheeling Diode
IF			1	Amps	Recommended Diode Continuous Current Rating
Diode Recommendation			BYV26C		Suggested Freewheeling Diode
OUTPUT INDUCTOR					
Core type	Ferrite		Ferrite		Select core type between Ferrite and Off-the-Shelf
Core size	EE10		EE10		Select core size
Custom Core					Enter custom core description (if used)
AE			12.1	mm ²	Core Effective Cross Sectional Area
LE			26.1	mm	Core Effective Path Length
AL			850	nH/T ²	Ungapped Core Effective Inductance
BW			6.6	mm	Bobbin Physical Winding Width
NL			149.6667555		Number of turns on inductor
BP			3100	Gauss	Peak flux density
LG			2.253983597	mm	Gap length
OD			0.132293908		Maximum Primary Wire Diameter including insulation
INS			0.031219467		Estimated Total Insulation Thickness (= 2 * film thickness)



DIA			0.101074441		Bare conductor diameter
AWG			39		Primary Wire Gauge (Rounded to next smaller standard AWG value)
CM			12.69920842		Bare conductor effective area in circular mils
CMA			0.112907248		!!! INCREASE CMA > 200 (increase L(primary layers),decrease NS, use larger Core)
L			3		
LP	1400		1400	uH	Output Inductor, Recommended Standard Value
L_R	2		2	Ohms	DC Resistance of Inductor
IO_Average			112.474696		Average output current
ILRMS			112.474696	mA	Estimated RMS inductor current (at VMAX)
FEEDBACK COMPONENTS					
RFB	18.7		18.7	Ohms	Feedback Resistor. Use closest standard 1% value
CFB			22	uF	Feedback Capacitor
OUTPUT REGULATION					
IO_VACMIN			109.393596	mA	Output Current at VACMIN
IO_VACNOM			112.474696	mA	Output Current at VACNOM
IO_VACMAX			114.3382366	mA	Output Current at VACMAX



9 Performance Data

All measurements performed at room temperature ($\approx 25\text{ }^{\circ}\text{C}$) otherwise specified.

Input		Input Measurement				LED Load Measurement			Efficiency (%)	Regulation (%)
VAC (V_{RMS})	Freq (Hz)	V_{IN} (V_{RMS})	I_{IN} (mA_{RMS})	P_{IN} (W)	PF	V_{OUT} (V_{DC})	I_{OUT} (mA_{DC})	P_{OUT} (W)		
90	60	90.07	82.57	6.480	0.871	54.0400	108.050	5.918	91.33	-1.77
100	60	100.11	78.53	6.584	0.838	54.1400	110.150	6.024	91.49	0.14
115	60	110.12	73.24	6.555	0.813	54.1400	110.080	6.006	91.62	0.07
120	60	120.12	69.70	6.566	0.784	54.1600	110.500	6.021	91.70	0.45
132	60	135.16	67.07	6.564	0.724	54.1600	110.590	6.015	91.64	0.54
190	50	190.30	57.15	6.386	0.587	54.0200	107.810	5.836	91.39	-1.99
200	50	200.41	56.02	6.359	0.566	53.9900	107.310	5.805	91.29	-2.45
220	50	220.35	54.16	6.308	0.529	53.9400	106.430	5.749	91.14	-3.25
230	50	230.37	53.68	6.286	0.508	53.9200	106.010	5.723	91.04	-3.63
240	50	264.15	55.86	6.726	0.456	54.2500	112.380	6.098	90.66	2.16
265	50	90.07	82.57	6.480	0.871	54.0400	108.050	5.918	91.33	-1.77



9.1 Active Mode Efficiency

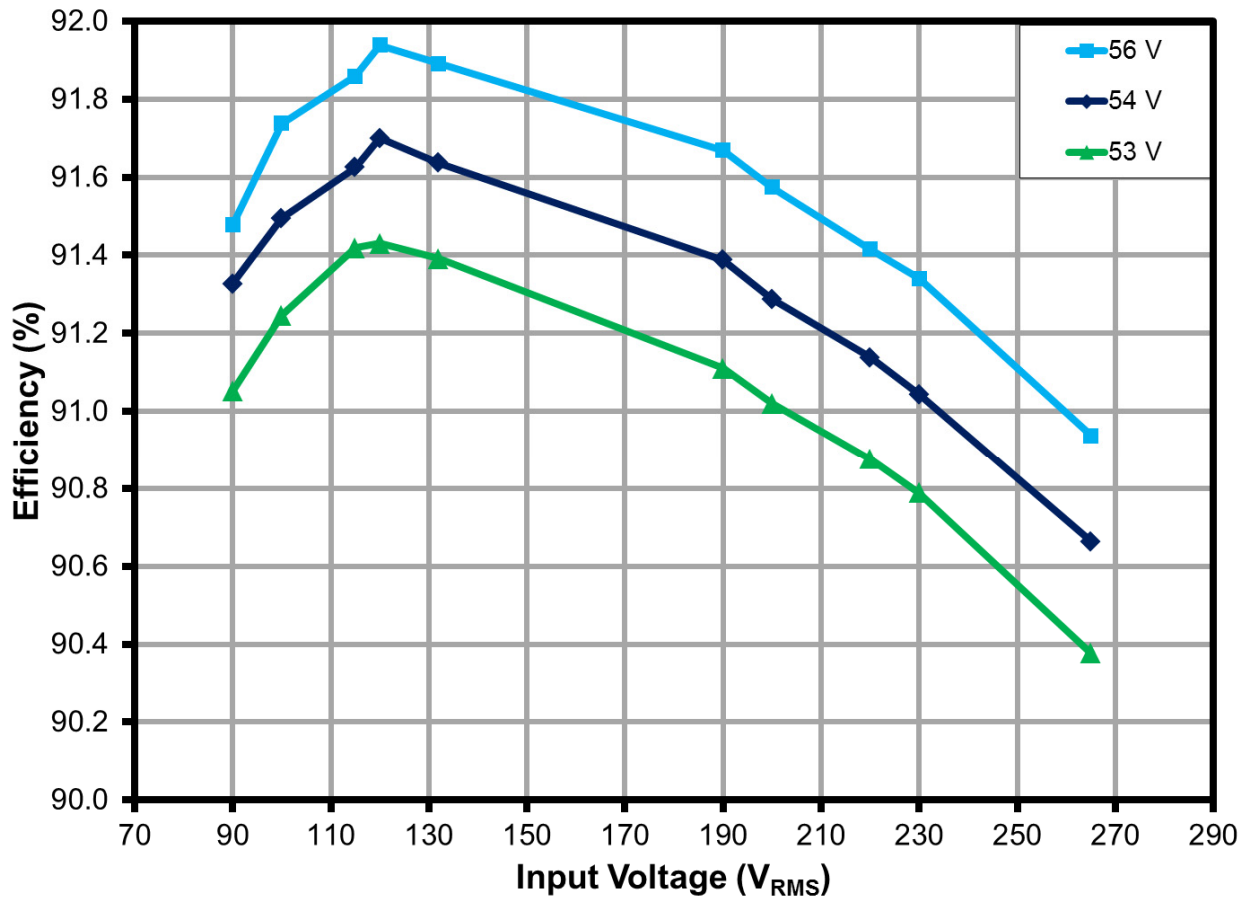

Figure 9 – Efficiency with Respect to AC Input Voltage. 90-132 VAC (50 Hz) and 190-265 VAC (60 Hz) Input.



9.2 Output Current Regulation

9.2.1 Input Line and Load Voltage to Output Current Regulation

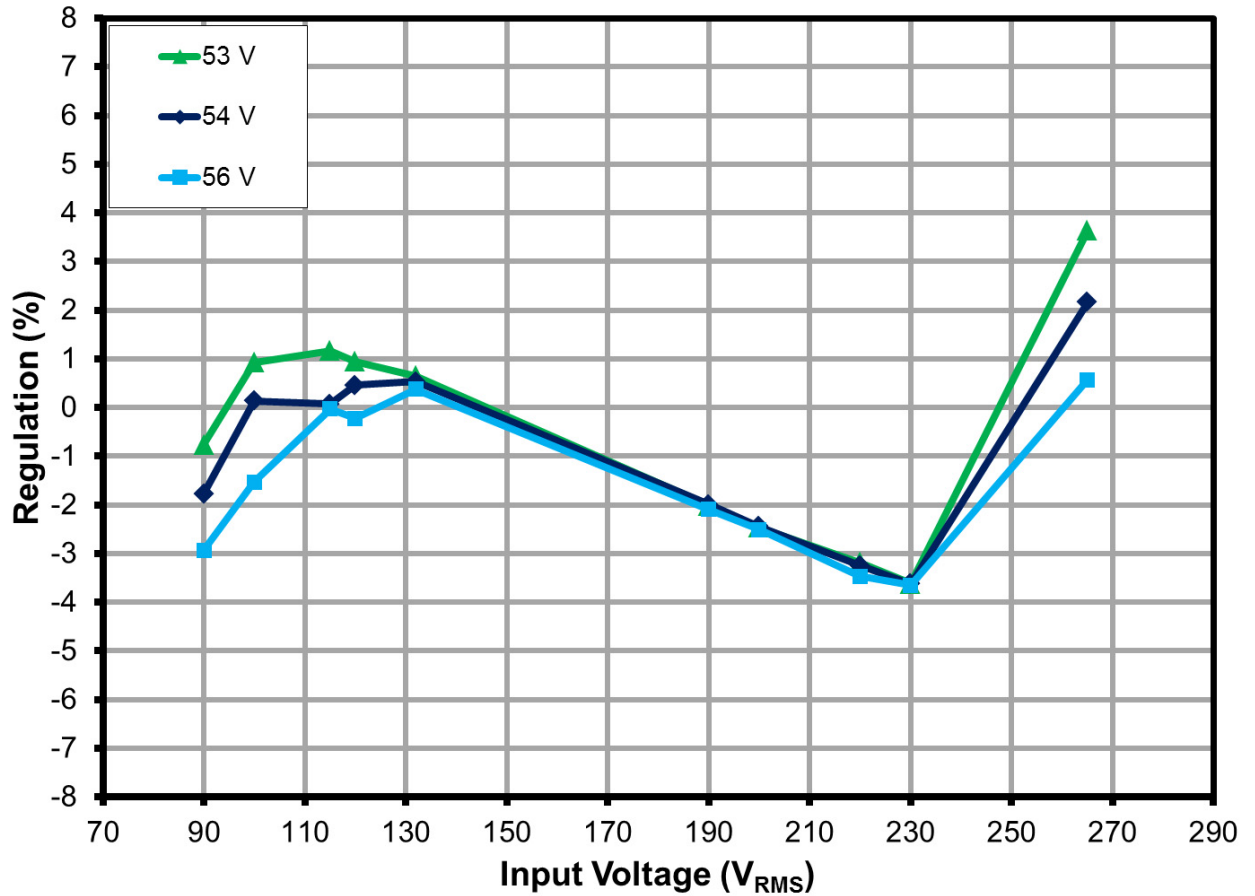

Figure 10 – Load Regulation, Room Temperature.



10 Thermal Performance

10.1 Equipment Used

Chamber:	Tenney Environmental Chamber Model No: TJR-17 942	Wattmeter:	Yokogawa Power Meter Model No: WT2000
AC Source:	Chroma Programmable AC Source Model No: 6415	Data Logger:	Yokogawa Model: 2008-3-4-2-2-1D SN: S5L409310



Figure 11 – Thermal Chamber Set-up Showing Box Used to Prevent Airflow Over UUT.

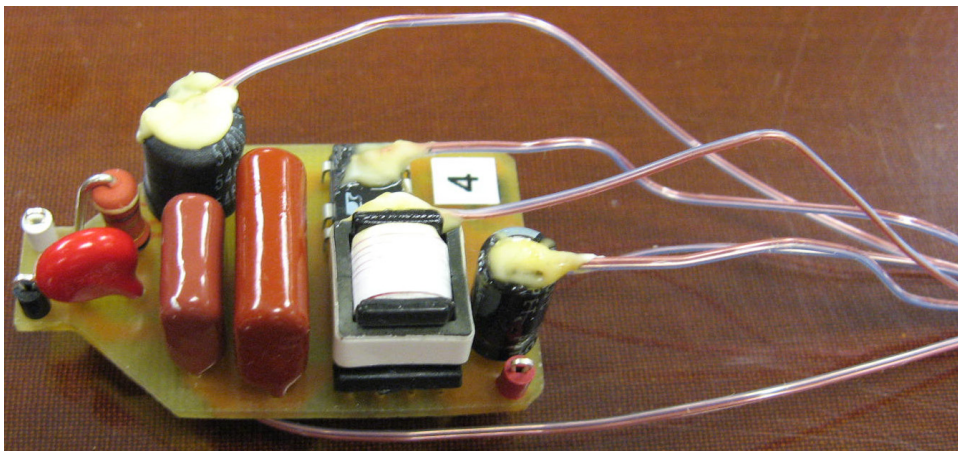

Figure 12 – Thermal Unit Thermocouple Measurement Set-up.



11 Thermal Result

Input: 90 VAC / 60 Hz

Load: 54 V / 110 m A LED load.

Location	Temperature								Thermal Shutdown	Thermal Recovery
Ambient	23.3	38.7	47.9	58.4	70.0	80.0	90.0	100.0	107.9	40.5
Bridge	37.8	52.4	60.8	70.9	80.7	89.6	99.0	108.5	115.1	64.4
L1	37.2	52.7	60.9	71.2	81.9	90.6	100.4	109.9	117.8	60.2
L2	39.4	54.6	63.7	73.9	84.7	93.4	103.2	112.7	120.6	63.0
IC	40.9	56.9	66.1	76.9	87.6	97.5	107.5	117.8	125.0	61.7
Diode	38.0	53.5	62.8	73.5	83.9	93.3	103.1	113.0	120.1	59.4

Table 1 – Thermal Measurement.

Note: Unit will start reliably at -40 °C. Tests were performed but are not shown here.

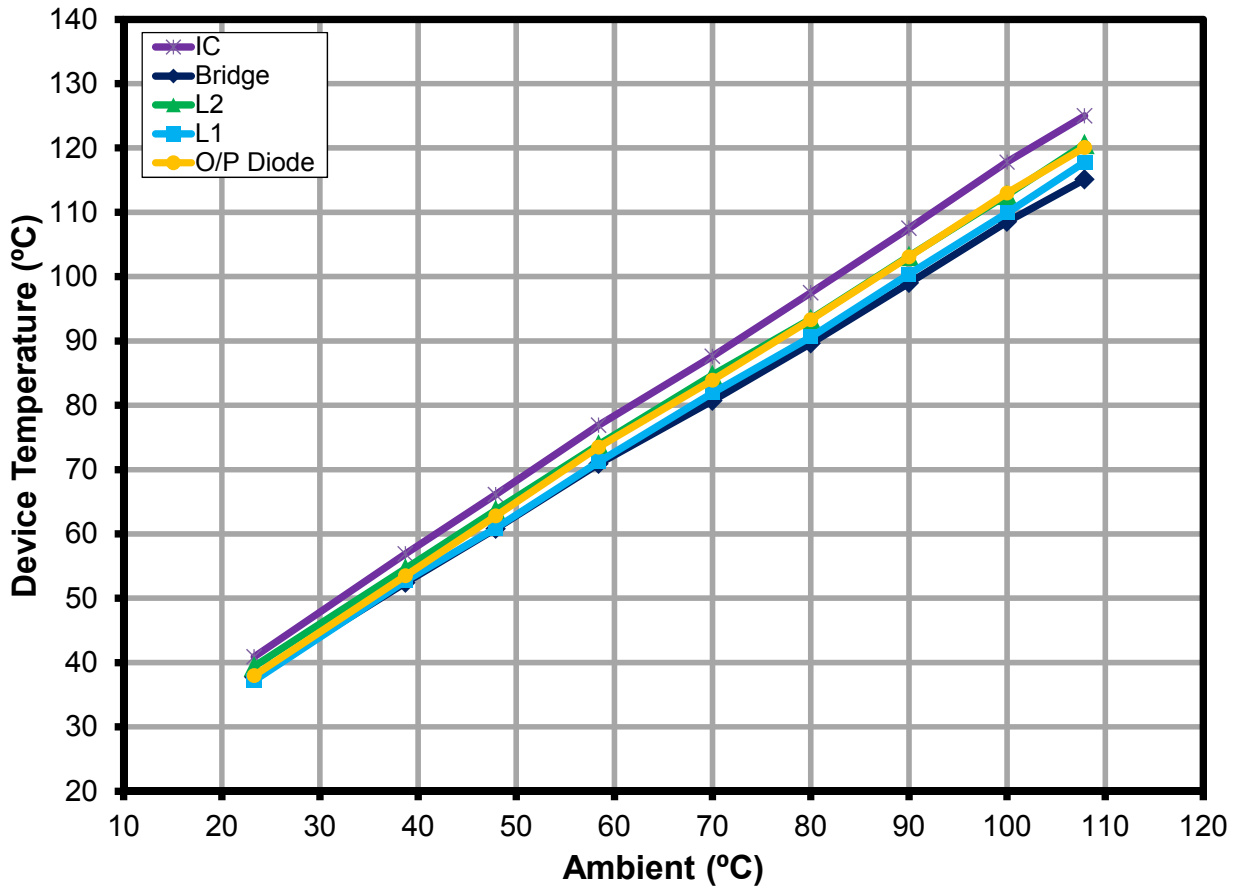

Figure 13 – Thermal Performance Curve.



11.1 Thermal Scan

Open-frame thermal measurement at 25°C ambient. UUT was soaked for 1 hour to achieve steady-state before the measurement.

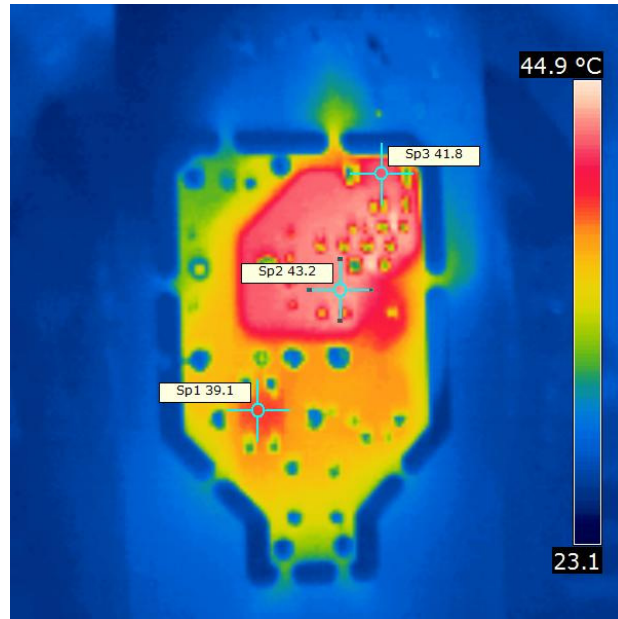
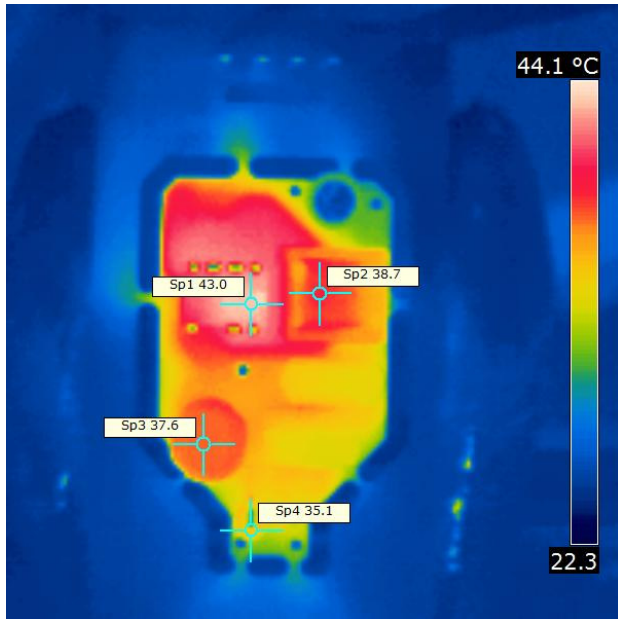

Figure 14 – Temperature (°C) at Top Side of PCB.
 SP1 – U1, LYT0006P.
 SP2 – L2, Power Inductor.
 SP3 – L1, EMI Choke.
 SP4 – FR1, Fusible Resistor.

Figure 15 – Temperature (°C) at Bottom Side of PCB.
 SP1 – BR1, Bridge Rectifier.
 SP2 – PCB, Trace Temperature.
 SP3 – D1, Freewheeling Diode.



12 Waveforms

12.1 Drain Voltage Normal Operation

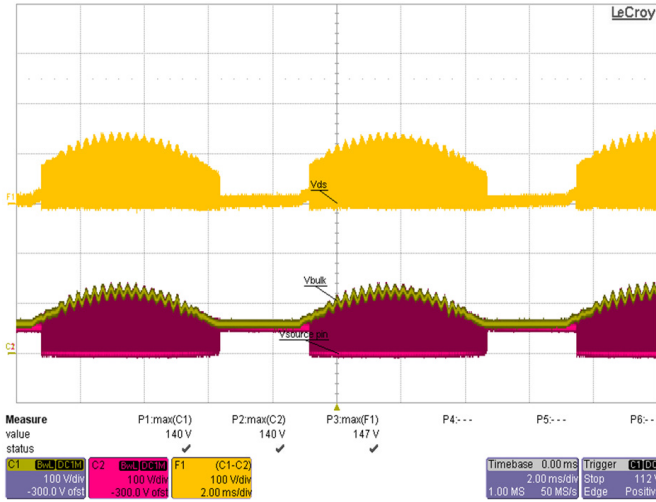

Figure 16 – 90 VAC, 60Hz, Full Load
 F1(Orange): $V_{DRAIN-SOURCE}$, 100 V / div.
 Ch1(Yellow): $V_{DRAIN-GND}$, 100 V / div.
 Ch2(Red): $V_{SOURCE-GND}$, 100 V, 2 ms / div.

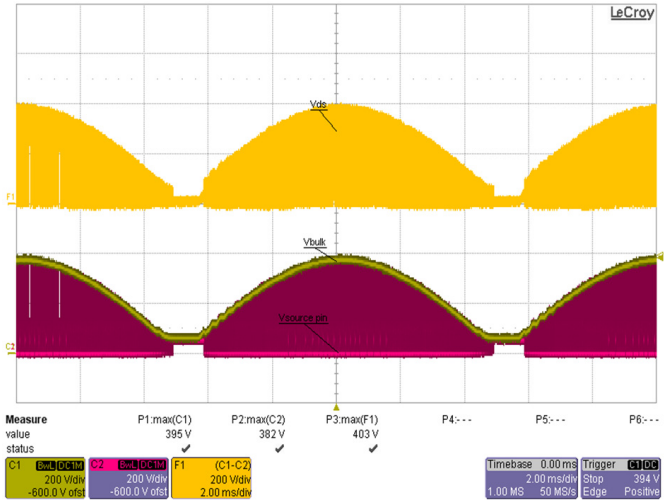

Figure 17 – 265 VAC, Full Load
 F1(Orange): $V_{DRAIN-SOURCE}$, 200 V / div.
 Ch1(Yellow): $V_{DRAIN-GND}$, 200 V / div.
 Ch2(Red): $V_{SOURCE-GND}$, 200 V, 2 ms / div.

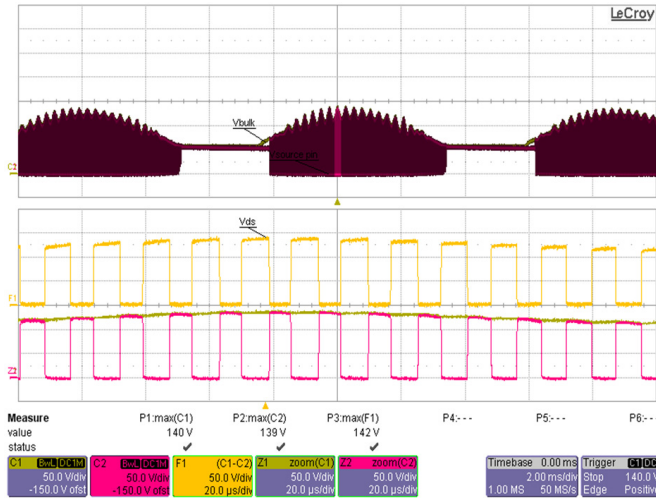

Figure 18 – 90 VAC, 60Hz, Full Load
 F1(Orange): $V_{DRAIN-SOURCE}$, 50 V / div.
 Ch1(Yellow): $V_{DRAIN-GND}$, 50 V / div.
 Ch2(Red): $V_{SOURCE-GND}$, 50 V, 2 ms / div.
 Z1(Yellow): $V_{DRAIN-GND}$, 50 V / div.
 Z2(Red): $V_{SOURCE-GND}$, 50 V, 20 μ s / div.

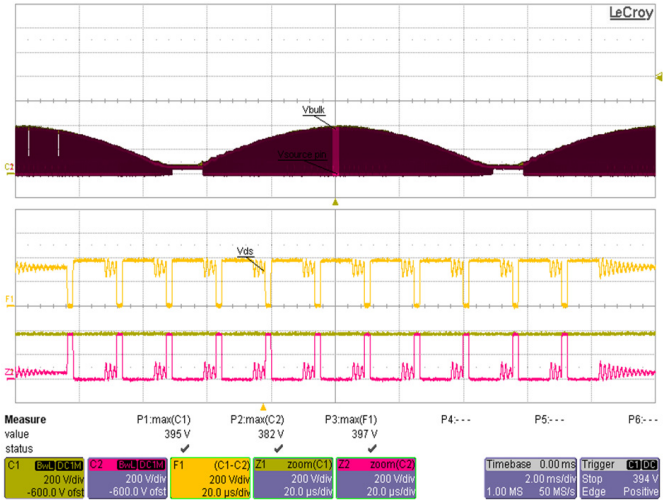

Figure 19 – 265 VAC, Full Load
 F1(Orange): $V_{DRAIN-SOURCE}$, 200 V / div.
 Ch1(Yellow): $V_{DRAIN-GND}$, 200 V / div.
 Ch2(Red): $V_{SOURCE-GND}$, 200 V, 2 ms / div.
 Z1(Yellow): $V_{DRAIN-GND}$, 200V / div.
 Z2(Red): $V_{SOURCE-GND}$, 200 V, 20 μ s / div.



12.2 Drain Current at Normal Operation

Missing pulses are normal and are used to regulate the output current. These missing pulses are present every time the sense resistor (R2) voltage-drop reaches 1.65 V. The unit will enter into auto-restart if there is not at least one missing pulse within 50 ms. For some designs wherein the power inductance is high and operating mostly in CCM, a reverse current may be present. One way to avoid this is by increasing the device size or increase input capacitance or adding a blocking diode in the drain. See AN-60 for more details.

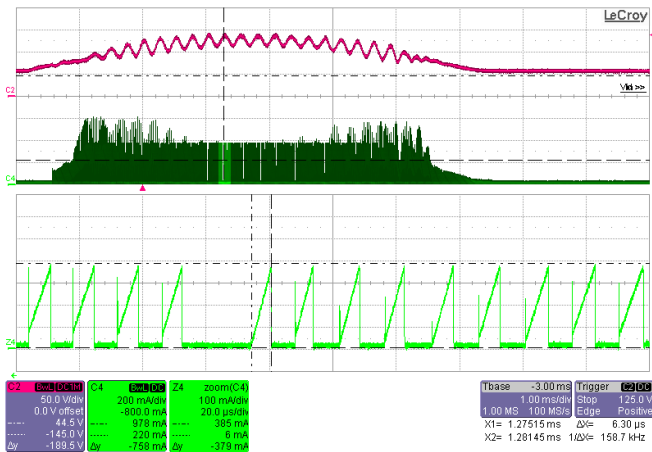

Figure 20 – 90 VAC, 60 Hz, 54 V_{LED}
 Ch2(Red): V_{BULK}, 50V / div.
 Ch4(Green): I_{DRAIN}, 200 mA / div., 1 ms / div.
 Z2(Green): I_{DRAIN}, 100 mA / div., 20 μs / div.

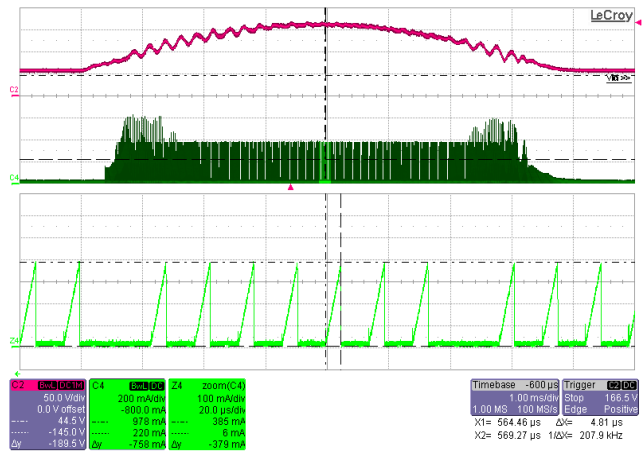

Figure 21 – 115 VAC, 60 Hz, 54 V_{LED}
 Ch2(Red): V_{BULK}, 50V / div.
 Ch4(Green): I_{DRAIN}, 200 mA / div., 1 ms / div.
 Z2(Green): I_{DRAIN}, 100 mA / div., 20 μs / div.



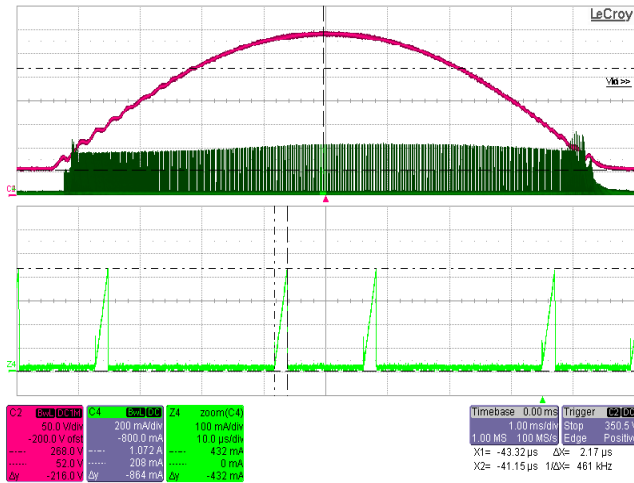

Figure 22 – 240 VAC, 60 Hz, 54 V_{LED}
 Ch2(Red): V_{BULK}, 50 V / div.
 Ch4(Green): I_{DRAIN}, 200 mA / div., 1 ms / div.
 Z2(Green): I_{DRAIN}, 100 mA / div., 20 μs / div.

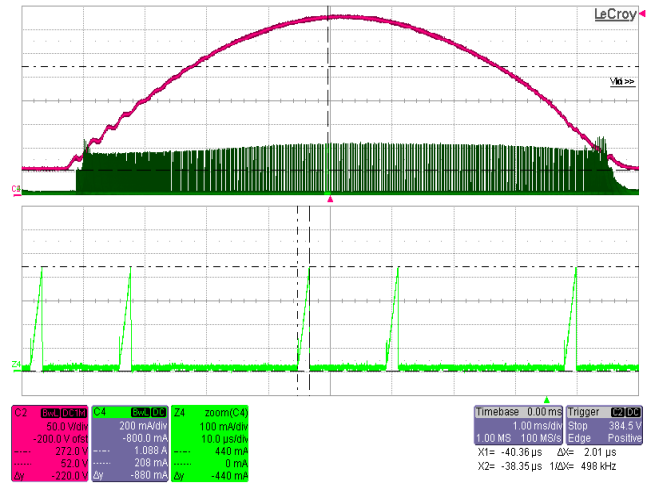

Figure 23 – 265 VAC, 60 Hz, 54 V_{LED}
 Ch2(Red): V_{BULK}, 50 V / div.
 Ch4(Green): I_{DRAIN}, 200 mA / div., 1 ms / div.
 Z2(Green): I_{DRAIN}, 100 mA / div., 20 μs / div.



12.3 Drain Voltage and Current When Output Short

Device is operating within the range and no inductor saturation was observed.

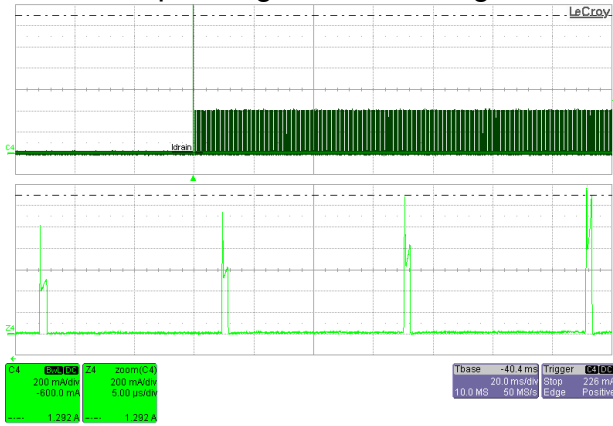

Figure 24 – LYT0006P Output Short.
 Ch4: I_{DRAIN} ; 0.2 A / div.
 Time Scale: 20 ms / div.
 Z4: V_{DS} ; 0.2 A / div.
 Zoom Time Scale: 5 μ s / div.

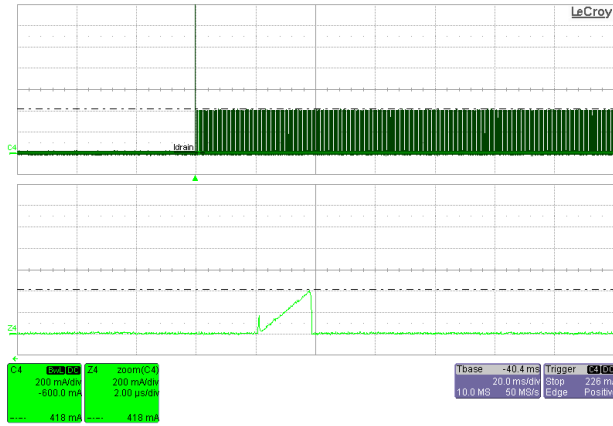

Figure 25 – LYT0006P Output Short.
 Ch4: I_{DRAIN} ; 0.2 A / div.
 Time Scale: 20 ms / div.
 Z4: V_{DS} ; 0.2 A / div.
 Zoom Time Scale: 2 μ s / div.

12.4 Drain Voltage and Current Start-up Profile

Device is operating within the range and no inductor saturation was observed.

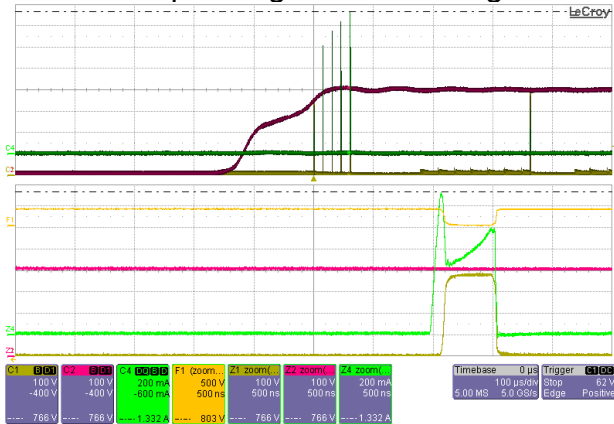

Figure 26 – 265 VAC / 50 Hz Start-up.
 Ch1, Z1: SOURCE Pin to Ground; 100 V / div.
 Ch2, Z2: Bulk Input; 100 V / div.
 Ch4, Z4: I_{DRAIN} ; 0.2 A / div.
 Time Scale: 100 μ s / div.
 F1: V_{DS} ; 100 V / div.
 Zoom Time Scale: 500 ns / div.

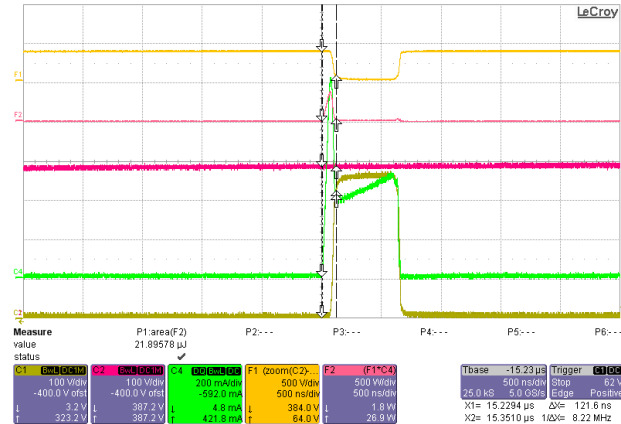

Figure 27 – 265 VAC / 50 Hz Start-up.
 Ch1: SOURCE Pin to Ground; 100 V / div.
 Ch2: Bulk Input; 100 V / div.
 Ch4: I_{DRAIN} ; 0.2 A / div.
 Time Scale: 500 ns / div.
 F1: V_{DS} ; 100 V / div.
 F2: Switching Power; 500 W / div.
 Zoom Time Scale: 500 ns / div.



12.5 Output Current Start-up Profile

Output current/light is present in just one AC cycle. <20 ms

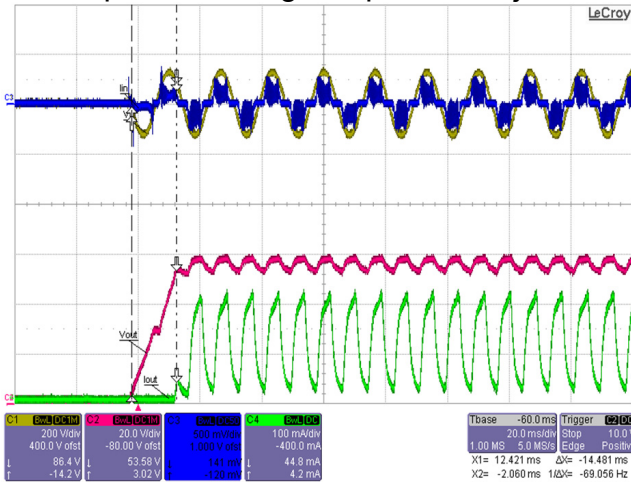

Figure 28 – 90 VAC, 60Hz, Full Load
 Ch1(Yellow): V_{IN} , 200 V / div.
 Ch2(Red): V_{OUT} , 20 V,
 Ch3(Blue): I_{IN} , 0.5 A / div.
 Ch4(Green): I_{OUT} , 100 mA / div., 20 ms / div.

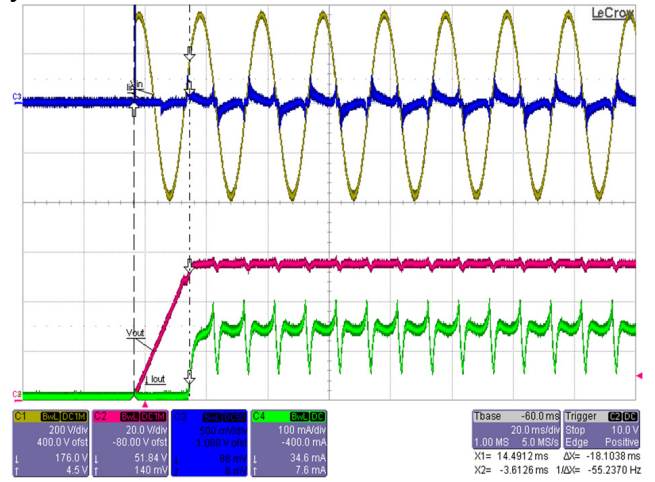

Figure 29 – 265 VAC, Full Load
 Ch1(Yellow): V_{IN} , 200 V / div.
 Ch2(Red): V_{OUT} , 20 V,
 Ch3(Blue): I_{IN} , 0.5 A / div.
 Ch4(Green): I_{OUT} , 100 mA / div., 20 ms / div.



12.6 Input-Output Profile

There is no limitation to the amount of output capacitance that can be added. If the application requires less output current ripple then increasing the output capacitance is straight forward. Note that the output current waveform below will vary depending on LED load impedance and will vary according to LED type.

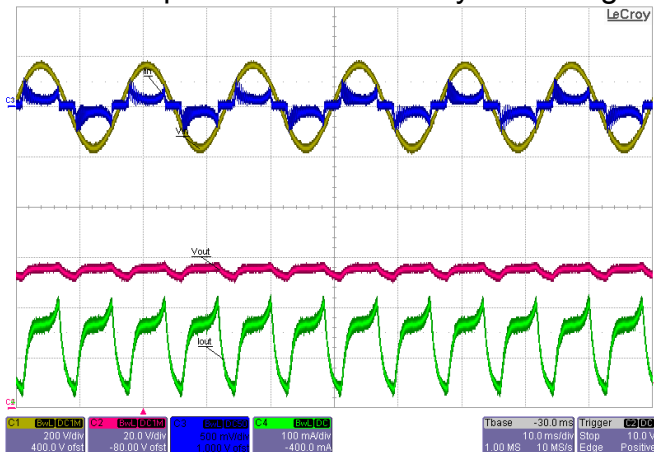

Figure 30 – 120 VAC, 60 Hz, Full Load
 Ch1(Yellow): V_{IN} , 200 V / div.
 Ch2(Red): V_{OUT} , 20 V.
 Ch3(Blue): I_{IN} , 0.5 A / div.
 Ch4(Green): I_{OUT} , 100 mA / div, 10 ms / div.

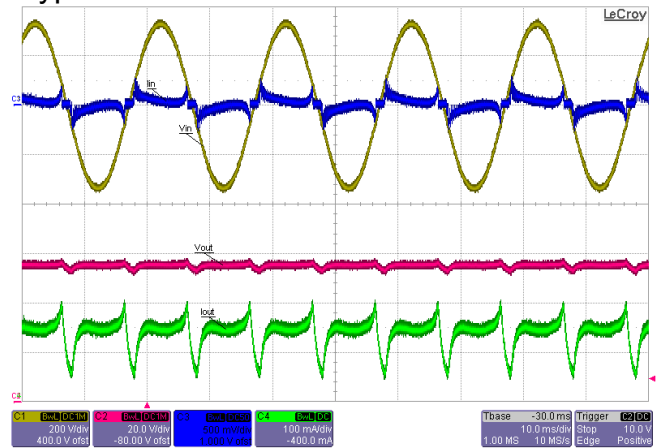

Figure 31 – 240 VAC, Full Load
 Ch1(Yellow): V_{IN} , 200 V / div.
 Ch2(Red): V_{OUT} , 20 V.
 Ch3(Blue): I_{IN} , 0.5 A / div.
 Ch4(Green): I_{OUT} , 100 mA / div, 10 ms / div.



12.7 Line Sag and Surge

The inherent advantage of the buck converter implemented with LYTSwitch-0 is the imperceptible start-up delay, the driver will turn-on within 20 ms as shown in the figures below. No failure of any component occurred during line fluctuation tests.

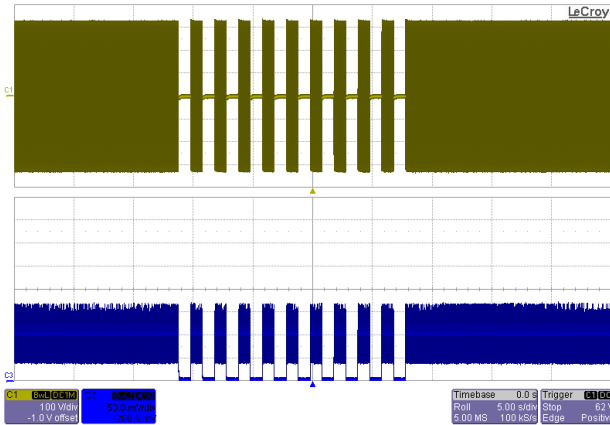

Figure 32 – Line sag test at 230 - 0 V at 1 Sec Interval.
 Ch1: V_{IN} ; 100 V / div.
 Ch2: I_{OUT} ; 50 mA / div.
 Time Scale: 5 s / div.

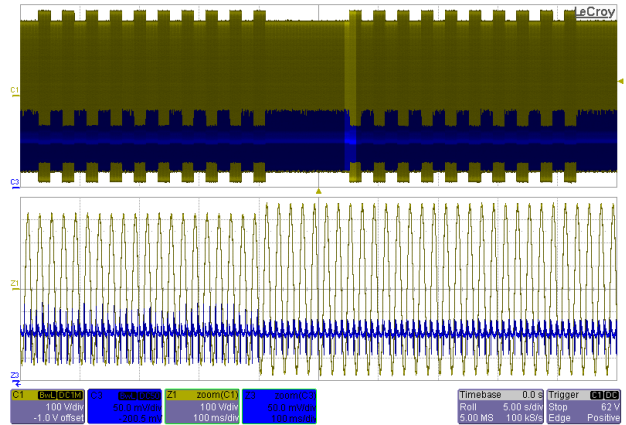

Figure 33 – Line Surge Test at 230 - 265 V at 1 Sec Interval.
 Ch1: V_{IN} ; 100 V / div.
 Ch2: I_{OUT} ; 50 mA / div.
 Time Scale: 5 s / div.

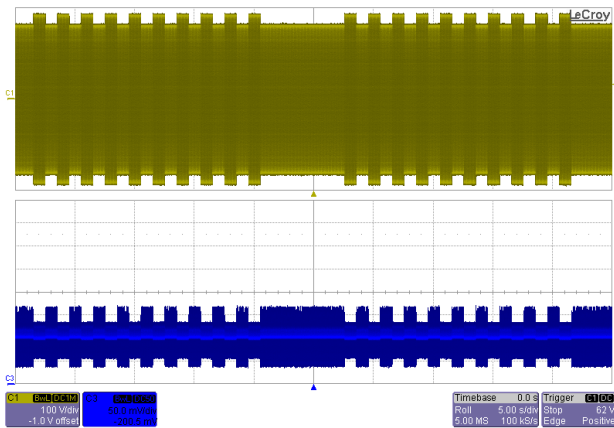

Figure 34 – Line Surge Test at 230 - 265 V at 1 Sec Interval.
 Ch1: V_{IN} ; 100 V / div.
 Ch2: I_{OUT} ; 50 mA / div.
 Time Scale: 5 s / div.

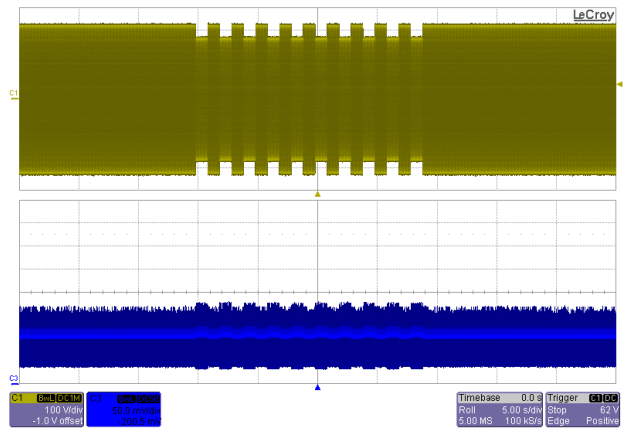

Figure 35 – Line Sag Test at 230 - 265 V at 1 Sec Interval.
 Ch1: V_{IN} ; 100 V / div.
 Ch2: I_{OUT} ; 50 mA / div.
 Time Scale: 5 s / div.



12.8 Brown-out/ Brown-in

No failure of any component during brownout test of 0.5 V / sec AC cut-in and cut-off.

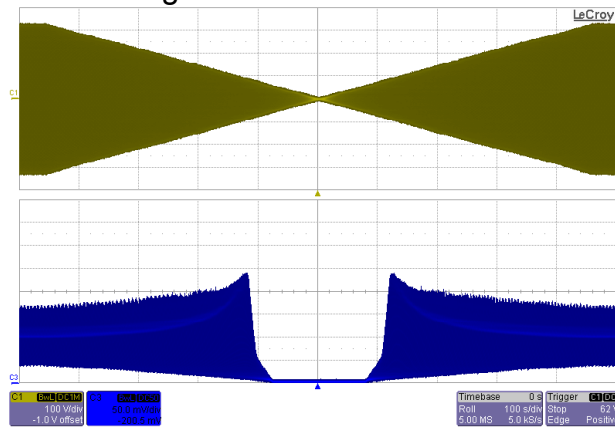

Figure 36 – Brown-out Test at 0.5 V / s. The Unit is Able to Operate Normally Without Any Failure and Without Flicker.
Ch1: V_{IN} ; 100 V / div.
Ch2: I_{OUT} ; 50 mA / div.
Time Scale: 100 s / div.



13 Line Surge

Differential input line 1.2 kV / 50 μ s surge testing was completed on a single test unit to IEC61000-4-5. Input voltage was set at 230 VAC / 60 Hz. Output was loaded at full load and operation was verified following each surge event.

Surge Level (V)	Input Voltage (VAC)	Injection Location	Injection Phase (°)	Test Result (Pass/Fail)
+500	230	L to N	90	Pass
-500	230	L to N	90	Pass
+500	230	L to N	270	Pass
-500	230	L to N	270	Pass
+500	230	L to N	0	Pass
-500	230	L to N	0	Pass

Unit passed under all test conditions.

Differential ring input line surge testing was completed on a single test unit to IEC61000-4-5. Input voltage was set at 230 VAC / 60 Hz. Output was loaded at full load and operation was verified following each surge event.

Surge Level (V)	Input Voltage (VAC)	Injection Location	Injection Phase (°)	Test Result (Pass/Fail)
+2500	230	L to N	90	Pass
-2500	230	L to N	90	Pass
+2500	230	L to N	270	Pass
-2500	230	L to N	270	Pass
+2500	230	L to N	0	Pass
-2500	230	L to N	0	Pass

Unit passed under all test conditions.



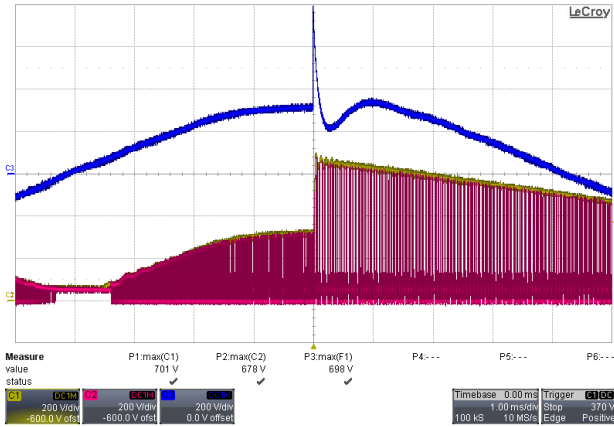

Figure 37 – Differential Line Surge at 500 V / 90°. Peak Drain Voltage Recorded is 678 V.
 Ch1: V_{IN}; 200 V / div.
 Ch2: V_{DRAIN}; 200 V / div.
 Ch3: V_{BULK}; 200 V / div.
 Time Scale: 1 ms / div.

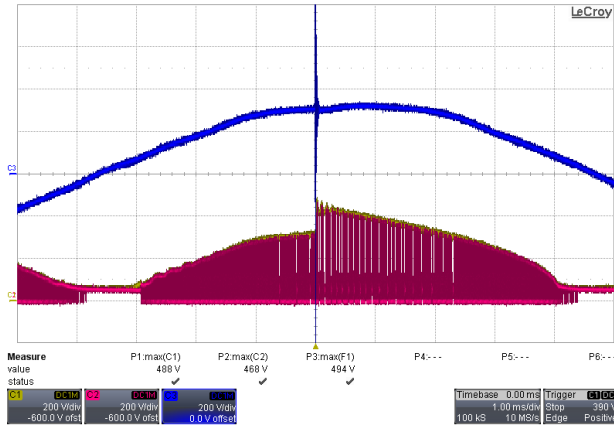

Figure 38 – Differential Ring Surge at 2500 V / 90°. Peak Drain Voltage Recorded is 468 V.
 Ch1: V_{IN}; 200 V / div.
 Ch2: V_{DRAIN}; 200 V / div.
 Ch3: V_{BULK}; 200 V / div.
 Time Scale: 1 ms / div.

14 Conducted EMI

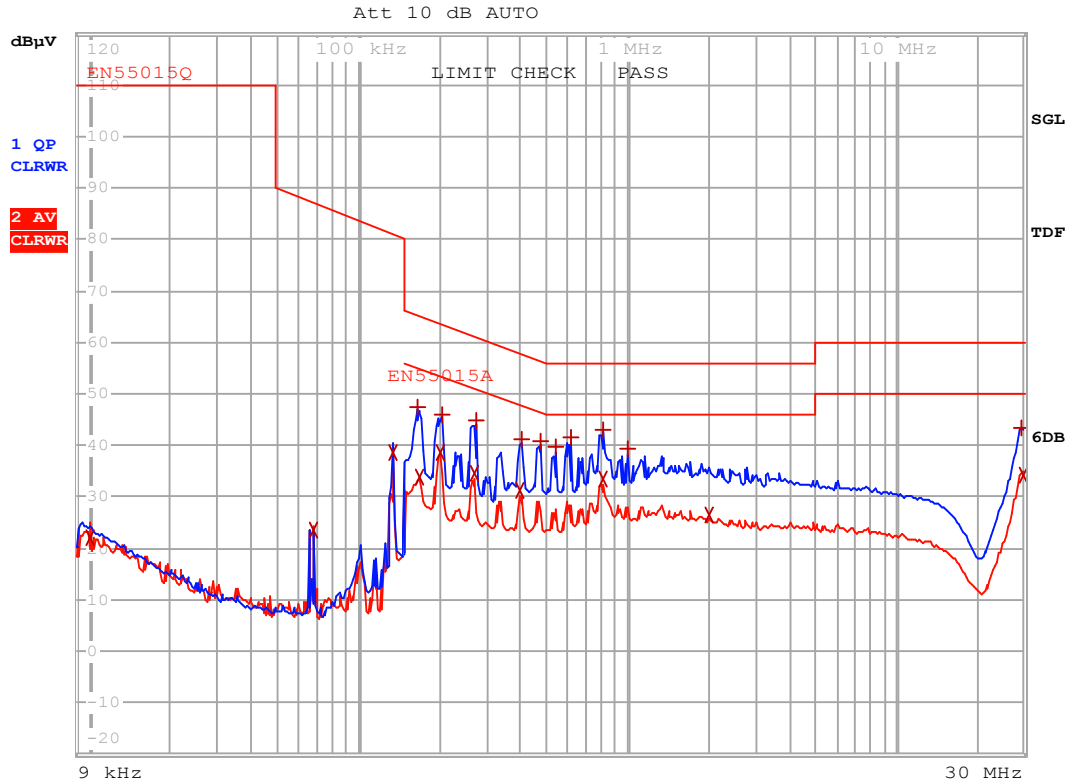

Figure 26 – Conducted EMI, Maximum Steady State Load, 120 VAC, 60 Hz, and EN55015 B Limits.

EDIT PEAK LIST (Final Measurement Results)						
Trace1:		EN55015Q				
Trace2:		EN55015A				
Trace3:		---				
TRACE		FREQUENCY	LEVEL dBµV		DELTA	LIMIT dB
2	Average	9.9415991287 kHz	22.25	N gnd		
2	Average	67.8393045788 kHz	23.52	N gnd		
2	Average	134.789536006 kHz	38.77	N gnd		
1	Quasi Peak	165.693318812 kHz	47.45	L1 gnd	-17.72	
2	Average	167.350252 kHz	33.66	N gnd	-21.42	
2	Average	200.175581485 kHz	38.55	N gnd	-15.05	
1	Quasi Peak	204.199110673 kHz	45.87	N gnd	-17.56	
2	Average	267.135089486 kHz	34.58	N gnd	-16.62	
1	Quasi Peak	272.504504785 kHz	44.83	N gnd	-16.20	
2	Average	397.727746704 kHz	31.37	N gnd	-16.53	
1	Quasi Peak	401.705024172 kHz	41.34	N gnd	-16.47	
1	Quasi Peak	475.741040231 kHz	40.79	N gnd	-15.62	
1	Quasi Peak	536.076911993 kHz	39.85	N gnd	-16.14	
1	Quasi Peak	610.105531335 kHz	41.66	N gnd	-14.33	
1	Quasi Peak	806.126927408 kHz	43.14	N gnd	-12.85	
2	Average	806.126927408 kHz	33.29	N gnd	-12.70	
1	Quasi Peak	1.00339897152 MHz	39.33	N gnd	-16.66	
2	Average	2.03372014292 MHz	26.57	N gnd	-19.42	
1	Quasi Peak	29.2697736439 MHz	43.21	L1 gnd	-16.78	
2	Average	29.5624713804 MHz	34.37	L1 gnd	-15.62	



Table 2 – Conducted EMI, Maximum Steady State Load, 120 VAC, 60 Hz, and EN55015 B Limits.

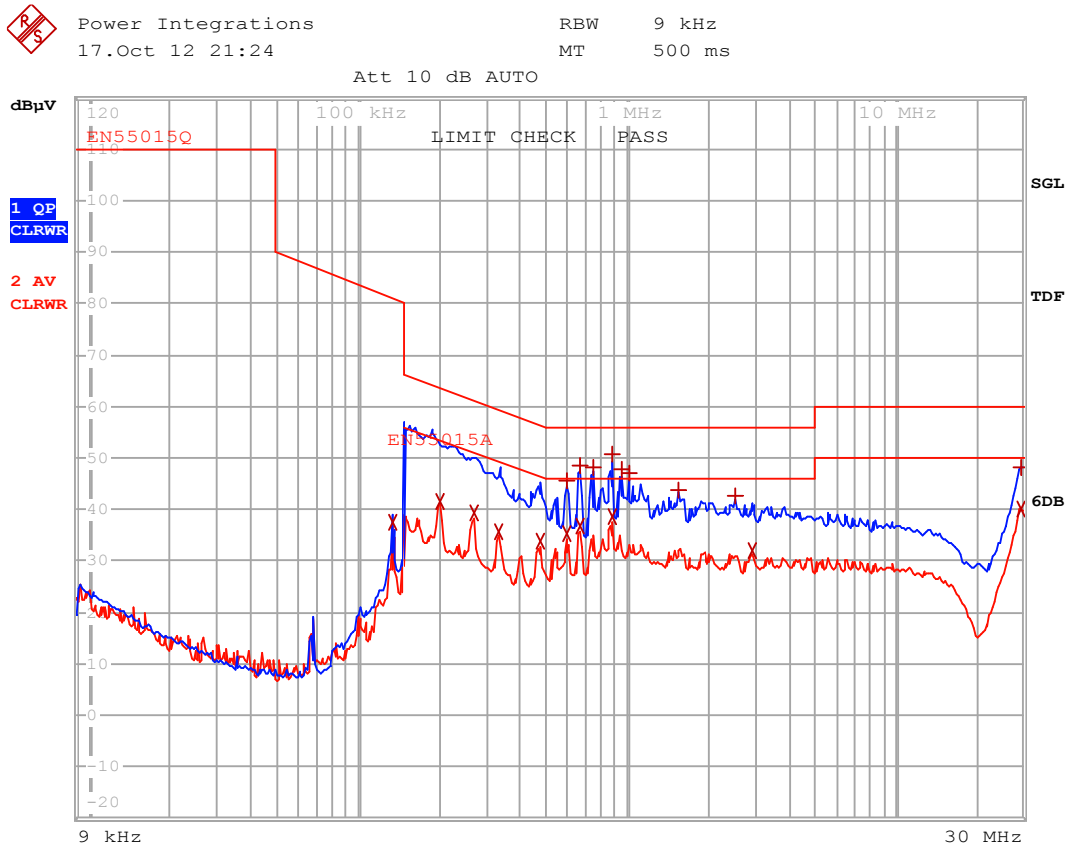

Figure 27 – Conducted EMI, Maximum Steady State Load, 230 VAC, 60 Hz, and EN55015 B Limits.

EDIT PEAK LIST (Final Measurement Results)				
Trace1:	EN55015Q			
Trace2:	EN55015A			
Trace3:	---			
TRACE	FREQUENCY	LEVEL dBµV		DELTA LIMIT dB
2 Average	134.789536006 kHz	37.65	L1 gnd	
2 Average	200.175581485 kHz	41.49	N gnd	-12.10
2 Average	267.135089486 kHz	39.23	N gnd	-11.97
2 Average	332.507282579 kHz	35.66	N gnd	-13.72
2 Average	475.741040231 kHz	33.70	N gnd	-12.71
1 Quasi Peak	592.16241791 kHz	45.66	N gnd	-10.33
2 Average	592.16241791 kHz	35.36	N gnd	-10.63
1 Quasi Peak	667.263434405 kHz	48.66	N gnd	-7.33
2 Average	667.263434405 kHz	36.60	N gnd	-9.39
1 Quasi Peak	744.444692652 kHz	48.12	N gnd	-7.87
1 Quasi Peak	872.919948931 kHz	50.67	N gnd	-5.32
2 Average	872.919948931 kHz	38.46	N gnd	-7.53
1 Quasi Peak	954.699692378 kHz	47.91	N gnd	-8.08
1 Quasi Peak	1.02356729084 MHz	47.16	N gnd	-8.83
1 Quasi Peak	1.55458365781 MHz	43.77	N gnd	-12.22
1 Quasi Peak	2.50634031306 MHz	42.47	N gnd	-13.53
2 Average	2.93888112801 MHz	31.88	N gnd	-14.11
1 Quasi Peak	29.2697736439 MHz	48.08	L1 gnd	-11.91
2 Average	29.2697736439 MHz	40.24	L1 gnd	-9.75

Table 3 – Conducted EMI, Maximum Steady State Load, 230 VAC, 60 Hz, and EN55015 B Limits.

15 Audible Noise

Input voltage were sweep from 90V to 265Vac at 60Hz line input.

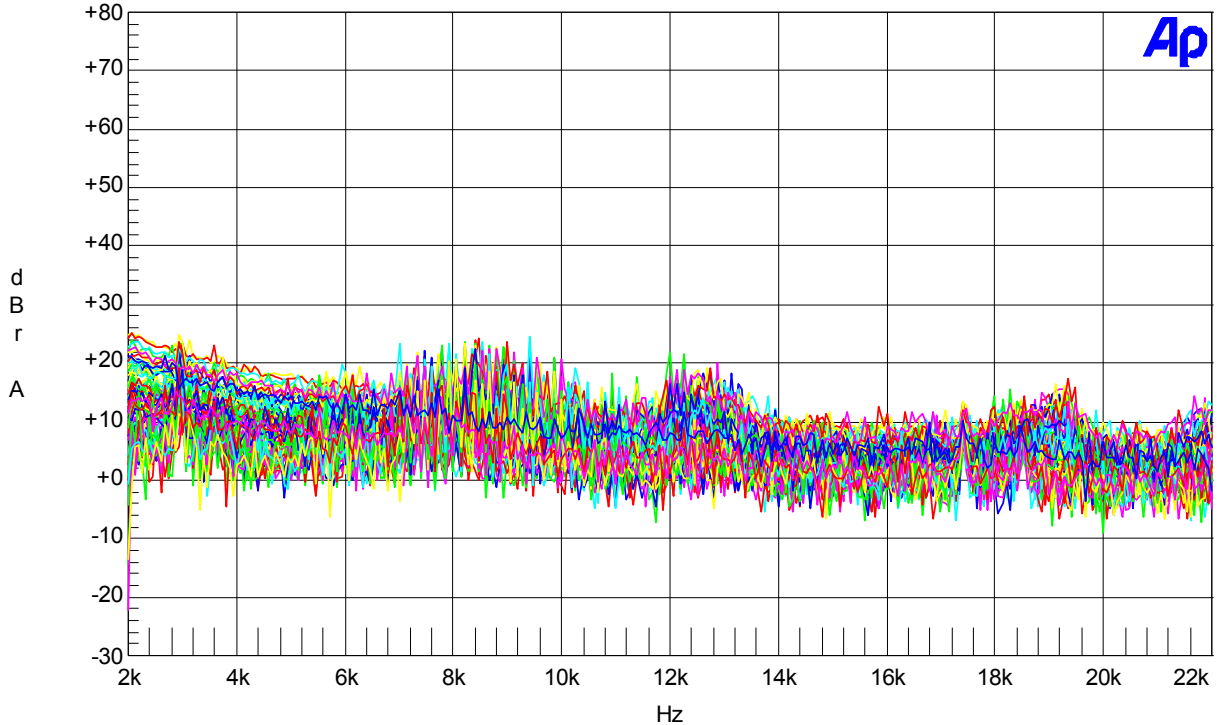

Color	Line Style	Thick	Data	Axis
Cyan	Solid	1	Fft.Ch.1 Ampl	Left
Green	Solid	1	Fft.Ch.1 Ampl	Left
Yellow	Solid	1	Fft.Ch.1 Ampl	Left

PI Standard Audio Noise (do not edit).at2

Figure 39 – Noise from the UUT at 1 cm from the Center of the Board to Microphone Receiver Position.



16 Appendix

Types of overvoltage protection for a buck converter:

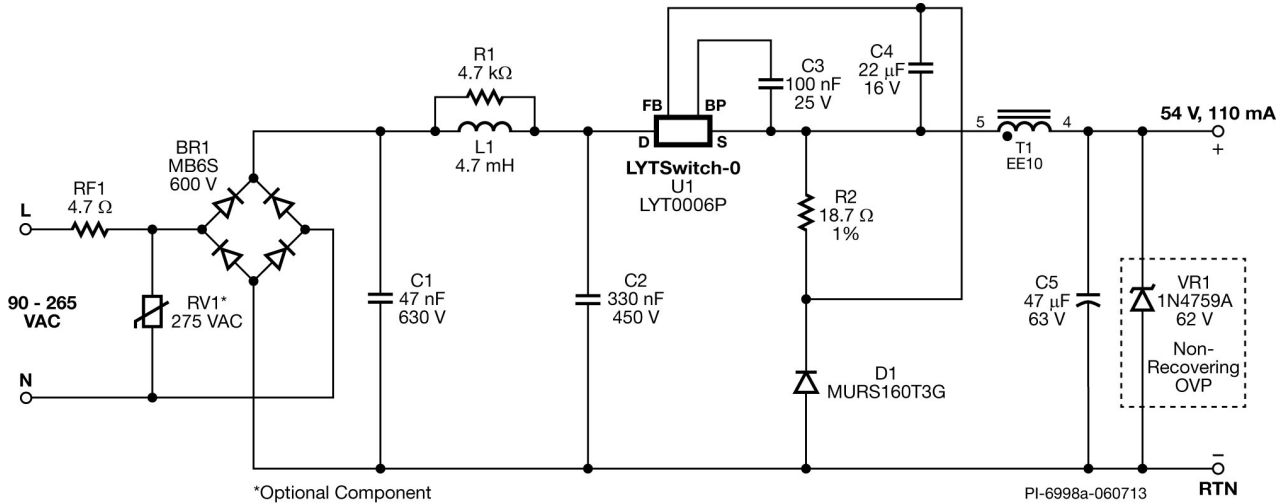

Figure 40 – Simple and cheapest approach is to add a Zener diode across the output terminals. In case of no load, the Zener diode will short in order and protect the output capacitor. IC U1 will be limited by the primary current limit. Note that the Zener diode will need to be replaced after this event.



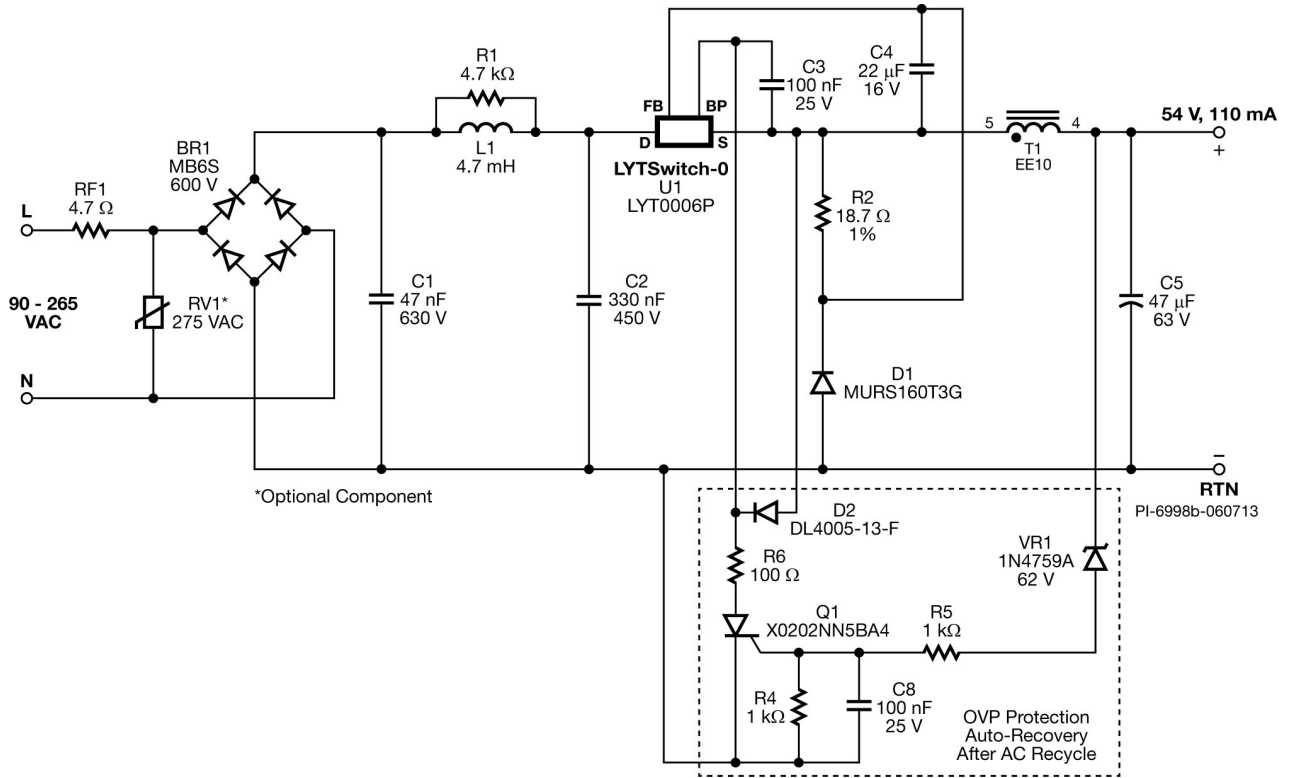

Figure 41 – Auto-recovery OVP latch protection. Once AC input is recycled for 2s, the unit will function normally once load is connected. Advantage is lowest no-load consumption and non-damaging failure.



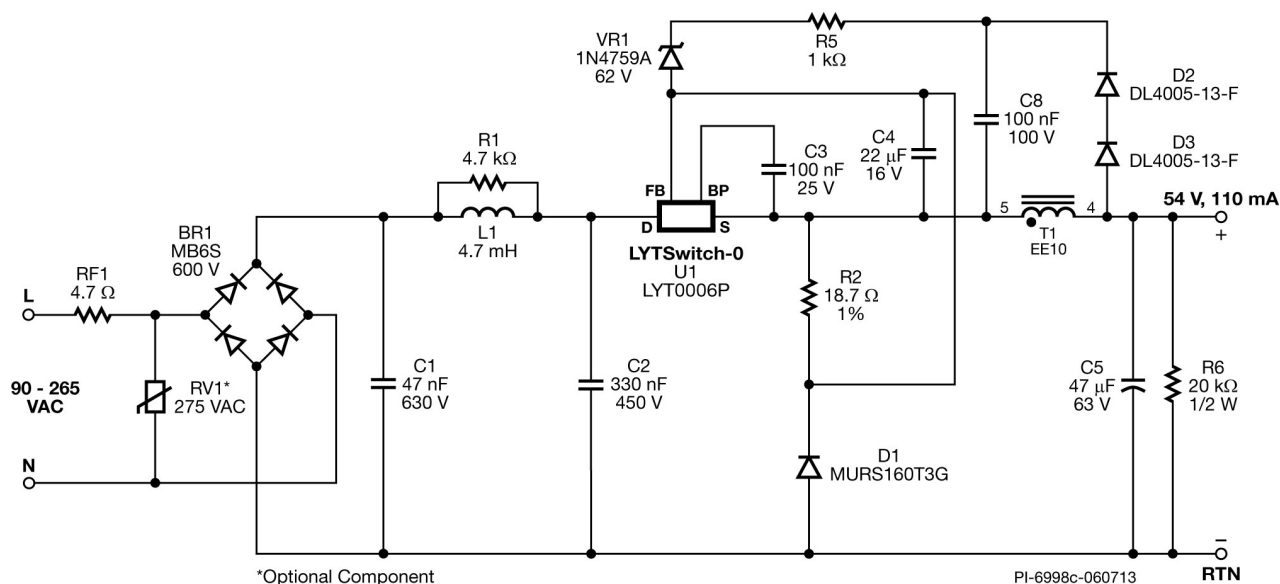

Figure 42 – Constant voltage (CV) mode protection. Load can be connected anytime without AC recycle. Disadvantage is it will require some pre-load in order to regulate, which decreases efficiency. Pre-load can be replaced by a appropriately rated Zener in series with a resistor if efficiency is a concern.

OVP Protection	Pros	Cons
Zener	<ol style="list-style-type: none"> 1. Cheapest and simple. 2. $V_{OUT} \approx 0\text{ V}$ at no-load; safe. 	<ol style="list-style-type: none"> 1. Non-auto recovery. Replace Zener once fault is removed.
SCR Latch	<ol style="list-style-type: none"> 1. Auto-recovery. 2. Lowest no-load consumption. 3. $V_{OUT} \approx 0\text{ V}$ at no-load; safe. 	<ol style="list-style-type: none"> 1. Cost. 2. Requires AC recycle for recovery.
Constant Voltage Mode	<ol style="list-style-type: none"> 1. Hot-plug, load can be connected anytime. 	<ol style="list-style-type: none"> 1. Consumes extra power. 2. Residual voltage at no-load. 3. Cost.

Table 4 – Overvoltage Protection Comparison.



17 Revision History

Date	Author	Revision	Description & changes	Reviewed
18-Jun-13	JDC	1.0	Initial Release	Apps & Mktg



For the latest updates, visit our website: www.powerint.com

Power Integrations reserves the right to make changes to its products at any time to improve reliability or manufacturability. Power Integrations does not assume any liability arising from the use of any device or circuit described herein. POWER INTEGRATIONS MAKES NO WARRANTY HEREIN AND SPECIFICALLY DISCLAIMS ALL WARRANTIES INCLUDING, WITHOUT LIMITATION, THE IMPLIED WARRANTIES OF MERCHANTABILITY, FITNESS FOR A PARTICULAR PURPOSE, AND NON-INFRINGEMENT OF THIRD PARTY RIGHTS.

PATENT INFORMATION

The products and applications illustrated herein (including transformer construction and circuits' external to the products) may be covered by one or more U.S. and foreign patents, or potentially by pending U.S. and foreign patent applications assigned to Power Integrations. A complete list of Power Integrations' patents may be found at www.powerint.com. Power Integrations grants its customers a license under certain patent rights as set forth at <http://www.powerint.com/ip.htm>.

The PI Logo, TOPSwitch, TinySwitch, LinkSwitch, LYTSwitch, DPA-Switch, PeakSwitch, CAPZero, SENZero, LinkZero, HiperPFS, HiperTFS, HiperLCS, Qspeed, EcoSmart, Clampless, E-Shield, Filterfuse, StackFET, PI Expert and PI FACTS are trademarks of Power Integrations, Inc. Other trademarks are property of their respective companies. ©Copyright 2013 Power Integrations, Inc.

Power Integrations Worldwide Sales Support Locations**WORLD HEADQUARTERS**

5245 Hellyer Avenue
San Jose, CA 95138, USA.
Main: +1-408-414-9200
Customer Service:
Phone: +1-408-414-9665
Fax: +1-408-414-9765
e-mail: usasales@powerint.com

GERMANY

Lindwurmstrasse 114
80337, Munich
Germany
Phone: +49-895-527-39110
Fax: +49-895-527-39200
e-mail: eurosales@powerint.com

JAPAN

Kosei Dai-3 Building
2-12-11, Shin-Yokohama,
Kohoku-ku, Yokohama-shi,
Kanagawa 222-0033
Japan
Phone: +81-45-471-1021
Fax: +81-45-471-3717
e-mail: japansales@powerint.com

TAIWAN

5F, No. 318, Nei Hu Rd.,
Sec. 1
Nei Hu District
Taipei 11493, Taiwan R.O.C.
Phone: +886-2-2659-4570
Fax: +886-2-2659-4550
e-mail: taiwansales@powerint.com

CHINA (SHANGHAI)

Rm 1601/1610, Tower 1,
Kerry Everbright City
No. 218 Tianmu Road West,
Shanghai, P.R.C. 200070
Phone: +86-21-6354-6323
Fax: +86-21-6354-6325
e-mail: chinasales@powerint.com

INDIA

#1, 14th Main Road
Vasanthanagar
Bangalore-560052
India
Phone: +91-80-4113-8020
Fax: +91-80-4113-8023
e-mail: indiasales@powerint.com

KOREA

RM 602, 6FL
Korea City Air Terminal B/D,
159-6
Samsung-Dong, Kangnam-Gu,
Seoul, 135-728 Korea
Phone: +82-2-2016-6610
Fax: +82-2-2016-6630
e-mail: koreasales@powerint.com

EUROPE HQ

1st Floor, St. James's House
East Street, Farnham
Surrey GU9 7TJ
United Kingdom
Phone: +44 (0) 1252-730-141
Fax: +44 (0) 1252-727-689
e-mail: eurosales@powerint.com

CHINA (SHENZHEN)

3rd Floor, Block A,
Zhongtuo International Business
Center, No. 1061, Xiang Mei Rd,
FuTian District, ShenZhen,
China, 518040
Phone: +86-755-8379-3243
Fax: +86-755-8379-5828
e-mail: chinasales@powerint.com

ITALY

Via Milanese 20, 3rd. Fl.
20099 Sesto San Giovanni
(MI) Italy
Phone: +39-024-550-8701
Fax: +39-028-928-6009
e-mail: eurosales@powerint.com

SINGAPORE

51 Newton Road,
#19-01/05 Goldhill Plaza
Singapore, 308900
Phone: +65-6358-2160
Fax: +65-6358-2015
e-mail: singaporesales@powerint.com

APPLICATIONS HOTLINE

World Wide +1-408-414-9660

APPLICATIONS FAX

World Wide +1-408-414-9760



Power Integrations, Inc.

Tel: +1 408 414 9200 Fax: +1 408 414 9201
www.powerint.com

X-ON Electronics

Largest Supplier of Electrical and Electronic Components

Click to view similar products for [LED Lighting Development Tools](#) category:

Click to view products by [Power Integrations](#) manufacturer:

Other Similar products are found below :

[MIC2870YFT EV](#) [ADP8860DBCP-EVALZ](#) [LM3404MREVAL](#) [ADM8843EB-EVALZ](#) [TDGL014](#) [ISL97682IRTZEVALZ](#) [LM3508TLEV](#)
[EA6358NH](#) [MAX16826EVKIT](#) [MAX16839EVKIT+](#) [TPS92315EVM-516](#) [MAX1698EVKIT](#) [MAX6956EVKIT+](#) [OM13321,598](#) [DC986A](#)
[DC909A](#) [DC824A](#) [STEVAL-LLL006V1](#) [IS31LT3948-GRLS4-EB](#) [104PW03F](#) [PIM526](#) [PIM527](#) [MAX6946EVKIT+](#) [MAX20070EVKIT#](#)
[MAX21610EVKIT#](#) [MAX20090BEVKIT#](#) [MAX20092EVSYS#](#) [PIM498](#) [AP8800EV1](#) [ZXLD1370/1EV4](#) [MAX6964EVKIT](#)
[MAX25240EVKIT#](#) [MAX25500TEVKITC#](#) [MAX77961BEVKIT06#](#) [1216.1013](#) [TPS61176EVM-566](#) [TPS61197EVM](#) [TPS92001EVM-628](#)
[1270](#) [1271.2004](#) [1272.1030](#) [1273.1010](#) [1278.1010](#) [1279.1002](#) [1279.1001](#) [1282.1000](#) [1293.1900](#) [1293.1800](#) [1293.1700](#) [1293.1500](#)