

## Three Phase Rectifier Bridges

## PSD 125

$I_{dAVM}$  = 166 A  
 $V_{RRM}$  = 800-1800 V

Preliminary Data Sheet

$V_{RSM}$ V	$V_{RRM}$ V	Type
800	800	PSD 125/08
1200	1200	PSD 125/12
1400	1400	PSD 125/14
1600	1600	PSD 125/16
1800	1800	PSD 125/18

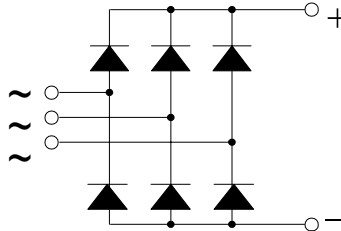

Symbol	Test Conditions	Maximum Ratings
$I_{dAVM}$	$T_C = 85^\circ\text{C}$ , module	166 A
$I_{FSM}$	$T_{VJ} = 45^\circ\text{C}$ $V_R = 0$ $t = 10$ ms (50 Hz), sine	1800 A
	$t = 8.3$ ms (60 Hz), sine	1950 A
	$T_{VJ} = T_{VJM}$ $V_R = 0$ $t = 10$ ms (50 Hz), sine	1600 A
	$t = 8.3$ ms (60 Hz), sine	1800 A
$\int i^2 dt$	$T_{VJ} = 45^\circ\text{C}$ $V_R = 0$ $t = 10$ ms (50 Hz), sine	16200 $\text{A}^2\text{s}$
	$t = 8.3$ ms (60 Hz), sine	16000 $\text{A}^2\text{s}$
	$T_{VJ} = T_{VJM}$ $V_R = 0$ $t = 10$ ms (50 Hz), sine	12800 $\text{A}^2\text{s}$
	$t = 8.3$ ms (60 Hz), sine	13600 $\text{A}^2\text{s}$
$T_{VJ}$		-40 ... + 150 $^\circ\text{C}$
$T_{VJM}$		150 $^\circ\text{C}$
$T_{stg}$		-40 ... + 150 $^\circ\text{C}$
$V_{ISOL}$	50/60 HZ, RMS $t = 1$ min	2500 V ~
	$I_{ISOL} \leq 1$ mA $t = 1$ s	3000 V ~
$M_d$	Mounting torque (M5)	5 Nm
	Terminal connection torque (M5)	5 Nm
Weight	typ.	240 g

### Features

- Package with screw terminals
- Isolation voltage 3000 V~
- Planar glasspassivated chips
- Blocking voltage up to 1800 V
- Low forward voltage drop
- UL registered E 148688

### Applications

- Supplies for DC power equipment
- Input rectifiers for PWM inverter
- Battery DC power supplies
- Field supply for DC motors

### Advantages

- Easy to mount with two screws
- Space and weight savings
- Improved temperature and power cycling capability

### Package, style and outline

Dimensions in mm (1mm = 0.0394")

Symbol	Test Conditions	Characteristic Value
$I_R$	$V_R = V_{RRM}$ $T_{VJ} = 25^\circ\text{C}$	$\leq 0.3$ mA
	$V_R = V_{RRM}$ $T_{VJ} = T_{VJM}$	$\leq 8.0$ mA
$V_F$	$I_F = 150$ A $T_{VJ} = 25^\circ\text{C}$	$\leq 1.3$ V
$V_{TO}$	For power-loss calculations only	0.8 V
$r_T$	$T_{VJ} = T_{VJM}$	3 $\text{m}\Omega$
$R_{thJC}$	per diode; DC current	0.83 K/W
	per module	0.138 K/W
$R_{thJK}$	per diode; DC current	1.13 K/W
	per module	0.188 K/W
$d_S$	Creeping distance on surface	14 mm
$d_A$	Creeping distance in air	14 mm
$a$	Max. allowable acceleration	50 $\text{m/s}^2$

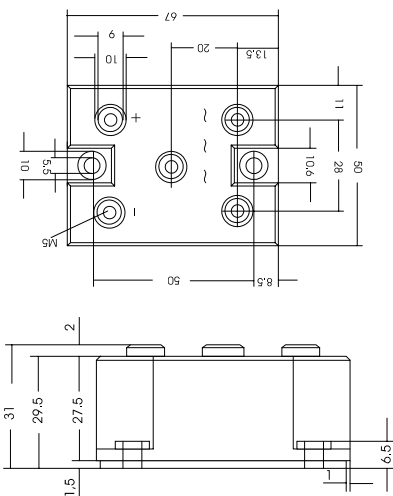

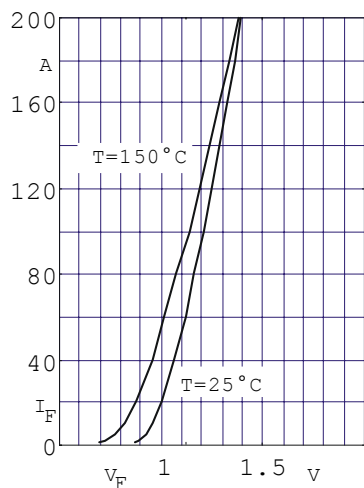

Fig. 1 Forward current versus voltage drop per diode

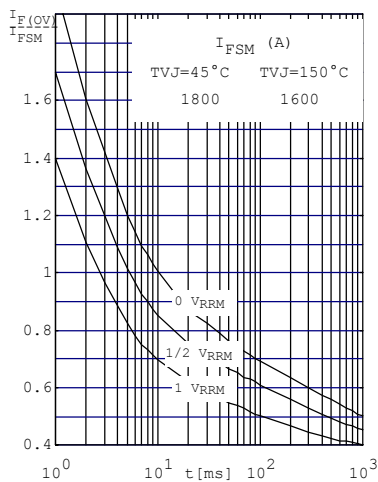

Fig. 2 Surge overload current per diode  $I_{FSM}$ : Crest value.  $t$ : duration

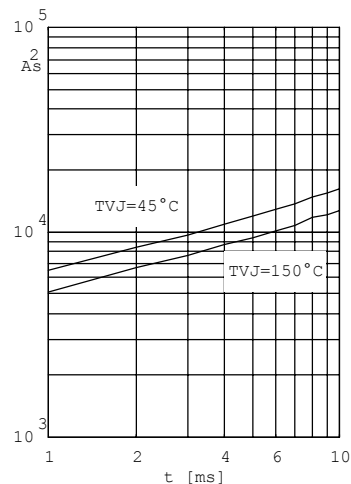

Fig. 3  $\int i^2 dt$  versus time (1-10ms) per diode (or thyristor)

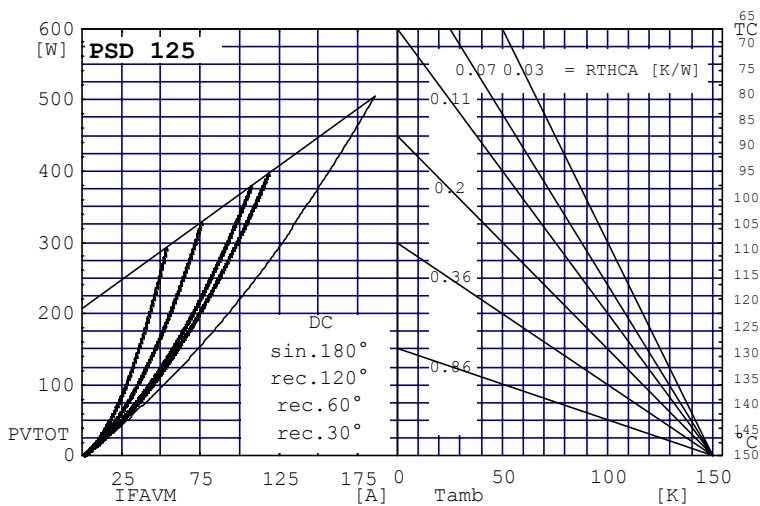

Fig. 4 Power dissipation versus direct output current and ambient temperature

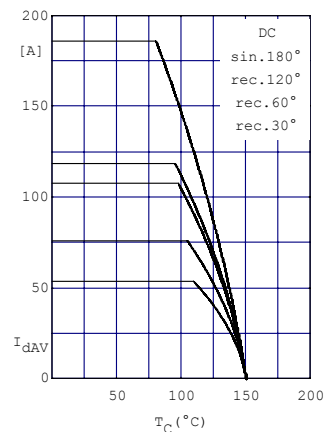

Fig.5 Maximum forward current at case temperature

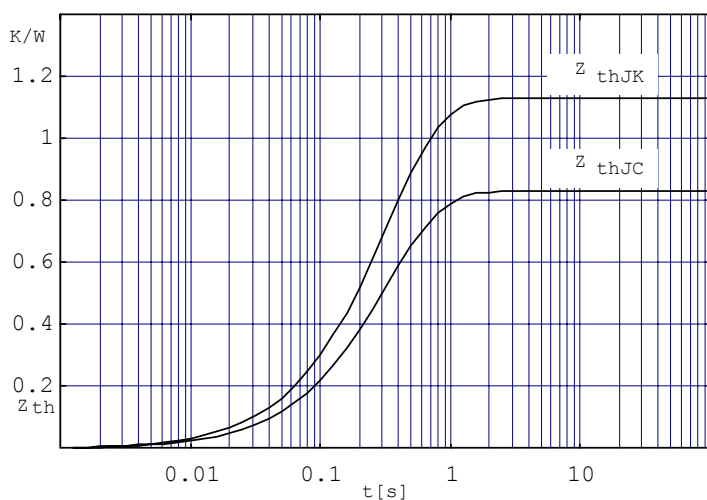

Fig. 6 Transient thermal impedance per diode (or thyristor), calculated

## X-ON Electronics

Largest Supplier of Electrical and Electronic Components

*Click to view similar products for [Bridge Rectifiers](#) category:*

*Click to view products by [Powersem](#) manufacturer:*

Other Similar products are found below :

[MB2510](#) [MB252](#) [MB356G](#) [MB358G](#) [GBJ1504-BP](#) [GBU15J-BP](#) [GBU15K-BP](#) [GBU4A-BP](#) [GBU4D-BP](#) [GBU6B-E3/45](#) [GSIB680-E3/45](#)  
[DB101-BP](#) [DF01](#) [DF10SA-E345](#) [BU1508-E3/45](#) [KBPC50-10S](#) [RS405GL-BP](#) [G5SBA60-E3/51](#) [GBJ1502-BP](#) [GBU10J-BP](#) [GBU4J-BP](#)  
[GBU6M](#) [GBU8D-BP](#) [GBU8J-BP](#) [GSIB1520-E3/45](#) [TB102M](#) [MB1510](#) [MB258](#) [MB6M-G](#) [MB86](#) [TL401G](#) [MDA920A2](#) [TU602](#) [TU810](#)  
[BR1005-BP](#) [BR101-BP](#) [BR84DTP204](#) [BU2008-E3/51](#) [36MB100A](#) [36MT160](#) [KBPC25-02](#) [VS-2KBB60](#) [DF06SA-E345](#) [DF1510S](#) [VS-](#)  
[40MT160PAPBF](#) [GBU4G-BP](#) [GBJ2506-BP](#) [GBU6B-E3/51](#) [GSIB15A80-E3/45](#) [DB104-BP](#)