

Sealed Nickel Cadmium Batteries High Temperature

Model: PS-CH

Specifications

Nominal Voltage		1.2 Volt
Rated Capacity		2200 mAh
Dimensions	Diameter in. (mm)	1.00 (25.3)
	Height in. (mm)	1.93 (49.0)
	Height with solder tabs	1.97 (50.0)
	Weight Approx.	65 gm
	Internal Resistance	<20 mΩ
	Standard Charge (0.1C)	220 mA
	Trickle Charge	110 mA
	Fast Charge ΔV	1100 mA
Recommended Operating Temperature Range	Std/Trickle Charge	0 to 70°C
	Fast Charge	0 to 70°C
	Discharge	-20 to 70°C
	Storage	-20 to 60°C
Standard Discharge (0.2C) Cut Off Voltage		1.0V per cell
High Rate Discharge (1 C) Cut Off Voltage		1.0V per cell

Dimensions

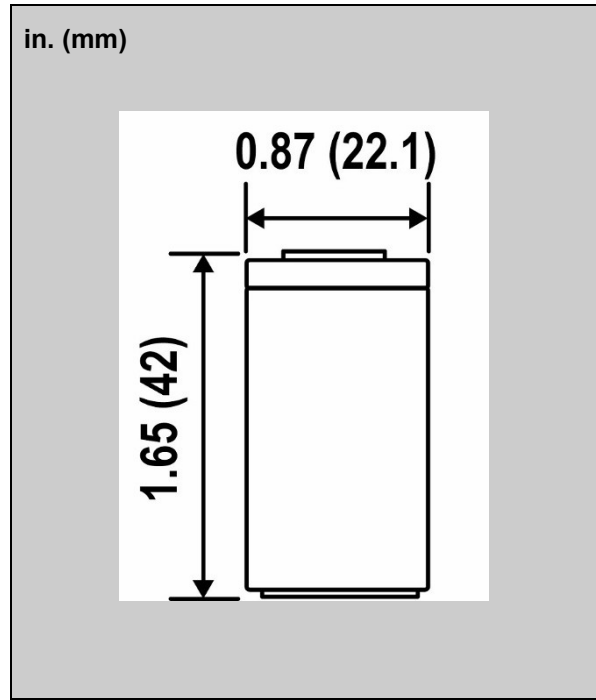

Charging and Discharging Characteristics

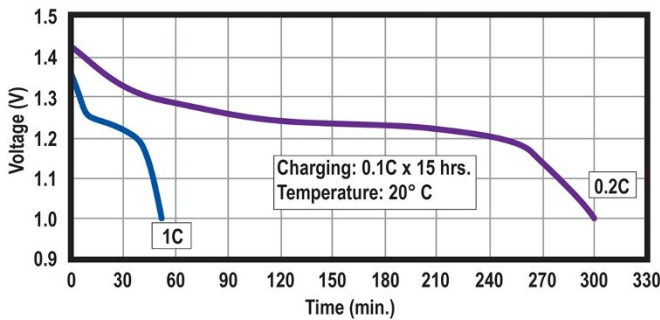

Discharge

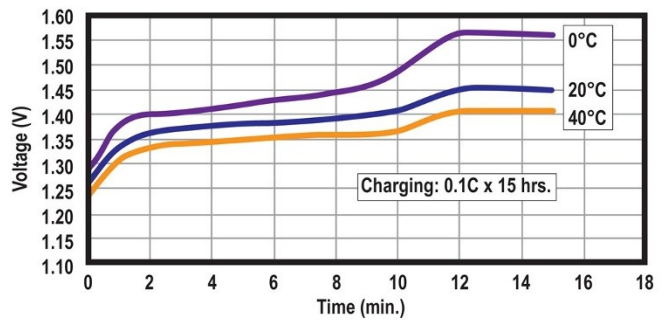

Standard Charge

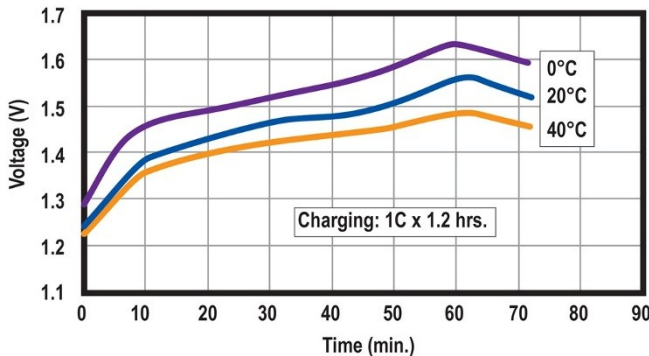

Fast Charge

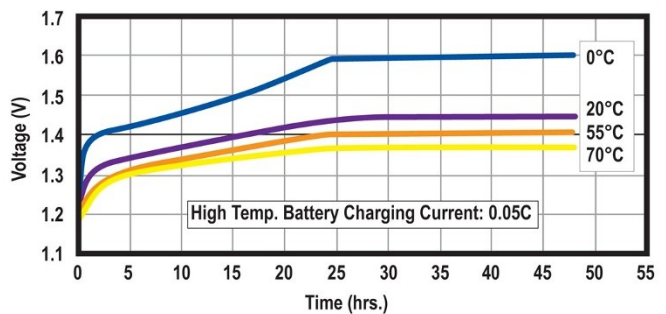

Trickle Charge

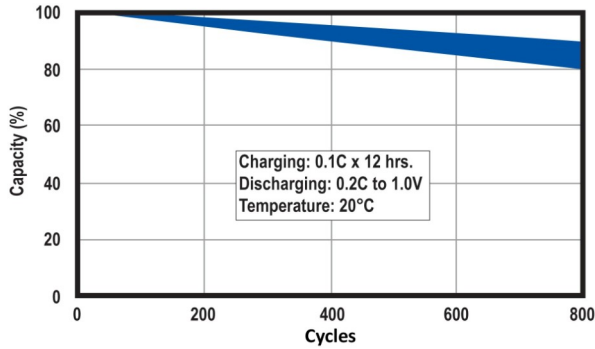

▲ Standard Battery Cycle Life ▲

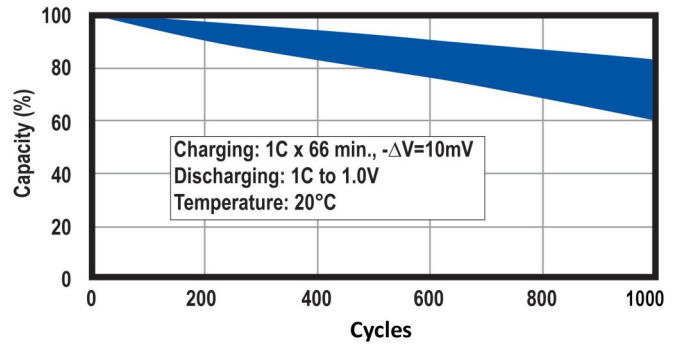

▲ Fast Charging Cycle Life ▲

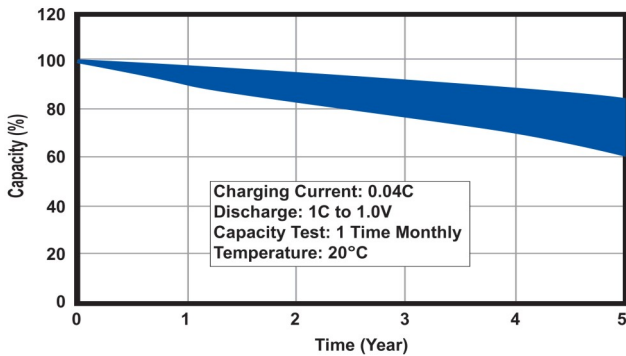

▲ Cycle Life Using Trickle Charging ▲

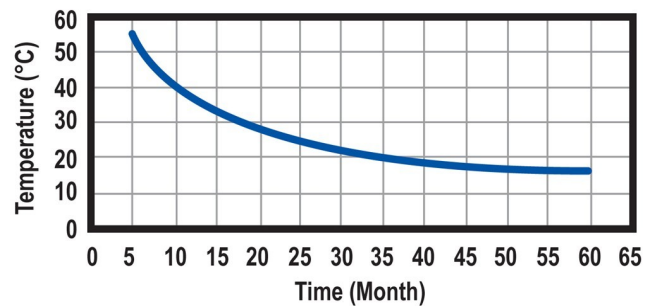

▲ Stand-by Battery Life ▲

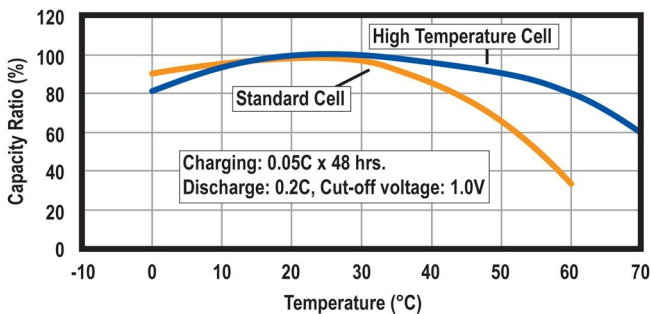

▲ Capacity vs. Temperature ▲

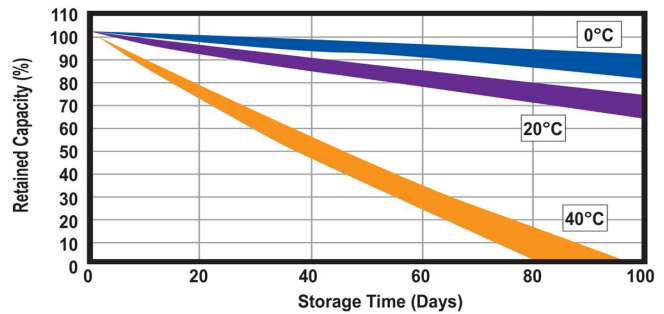

▲ Retained Capacity In Storage ▲

Corporate Headquarters and Domestic Sales

Power-Sonic Corporation • 7550 Panasonic Way • San Diego, CA 92154 • U.S.A

Phone: (619) 661-2020 • Fax: (619) 661.3650

Email Sales: national-sales@power-sonic.com

Email Customer Service: customer-service@power-sonic.com

E-mail Technical Support: technical-support@power-sonic.com

International Sales

Power-Sonic Corporation • P.O. Box 5242 • Redwood City, CA 94063 • U.S.A.

Phone: (650) 364-5001 • Fax: (650) 366-3662

Email Sales: international-sales.com@power-sonic.com

www.power-sonic.com

X-ON Electronics

Largest Supplier of Electrical and Electronic Components

Click to view similar products for [NiCd - Nickel Cadmium Battery](#) category:

Click to view products by [Power-Sonic](#) manufacturer:

Other Similar products are found below :

[PS-850AA-T](#) [PS-D-T](#) [PS-F](#) [PS-C-T](#) [PS-CX-T](#) [PS-C](#) [PS-AAX](#) [PS-850AA](#) [PS-1/2D](#) [N-700AAC](#) [15568-1](#) [PS-2/3AA](#) [PS-AA](#) [PS-2/3A-T](#) [PS-A](#) [PS-SC](#) [PS-AAX-T](#) [PS-1/2D-T](#) [PS-2/3A](#) [PS-AAA](#) [PS-D](#)