

### SPECIFICATIONS

<b>CUSTOMER</b>	:	<b>PTC</b>
<b>SAMPLE CODE</b>	:	<b>NSC1602WRP-FWT-I</b>
<b>MASS PRODUCTION CODE</b>	:	<b>NPC1602WRP-FWT-I</b>
<b>SAMPLE VERSION</b>	:	<b>01</b>
<b>SPECIFICATIONS EDITION</b>	:	<b>001</b>
<b>DRAWING NO. (Ver.)</b>	:	<b>JLMD- NPC1602WRP-FWT-I_001</b>
<b>PACKAGING NO. (Ver.)</b>	:	<b>JPKG- NPC1602WRP-FWT-I_001</b>

**Customer Approved**

---

**Date:**

Approved	Checked	Designer
閻偉	劉進	徐明菲

- Preliminary specification for design input
- Specification for sample approval

### POWER TIP TECH. CORP.

<b>Headquarters:</b> No.8, 6 <sup>th</sup> Road, Taichung Industrial Park, Taichung, Taiwan 台中市 407 工業區六路 8 號	TEL: 886-4-2355-8168 FAX: 886-4-2355-8166	E-mail: <a href="mailto:sales@powertip.com.tw">sales@powertip.com.tw</a> Http://www.powertip.com.tw
---	--	--



## Contents

### 1. SPECIFICATIONS

- 1.1 Features
- 1.2 Mechanical Specifications
- 1.3 Absolute Maximum Ratings
- 1.4 DC Electrical Characteristics
- 1.5 Optical Characteristics

### 2. MODULE STRUCTURE

- 2.1 Counter Drawing
- 2.2 Interface Pin Description
- 2.3 Timing Characteristics
- 2.4 Display Command
- 2.5 Character Pattern
- 2.6 Jumper (Setting different use)

### 3. QUALITY ASSURANCE SYSTEM

- 3.1 Quality Assurance Flow Chart
- 3.2 Inspection Specification

### 4. RELIABILITY TEST

- 4.1 Reliability Test Condition

### 5. PRECAUTION RELATING PRODUCT HANDLING

- 5.1 Safety
- 5.2 Handling
- 5.3 Storage
- 5.4 Terms of Warranty

#### Appendix :

- 1. LCM drawing
- 2. LCM Packaging Specifications

Note : For detailed information please refer to IC data sheet : SITRONIX---ST7066U-0T

## 1. SPECIFICATIONS

### 1.1 Features

Item	Standard Value
Display Type	16*2 Characters
LCD Type	PBT , Negative , Transmissive
Driver Condition	LCD Module : 1/16 Duty , 1/5 Bias
Backlight	White LED Backlight
Weight	40g
Interface	6800-series 8-bit parallel
Driver IC	ST7066U-0T
ROHS	THIS PRODUCT CONFORMS THE ROHS OF PTC Detail information please refer website : <a href="http://www.powertip.com.tw/news.php?area_id_view=1085560481/">http://www.powertip.com.tw/news.php?area_id_view=1085560481/</a>

### 1.2 Mechanical Specifications

Item	Standard Value	Unit
Outline Dimension	84.0 (L) * 44.0 (w) *13.2 (max) (H)	mm
Viewing Area	66.0 (L) * 16.0 (w)	mm
Active Area	56.2 (L) * 11.5 (w)	mm
Character Size	2.95mm * 5.55mm	mm
Character Pitch	3.55mm * 5.95mm	mm

Note : For detailed information please refer to LCM drawing

### 1.3 Absolute Maximum Ratings

Item	Symbol	Condition	Min.	Max.	Unit
Power Supply Voltage	V <sub>DD</sub>	-	-0.3	7.0	V
LCD Driver Supply Voltage	V <sub>LCD</sub>	-	V <sub>DD</sub> -10.0	V <sub>DD</sub> +0.3	
Input Voltage	V <sub>IN</sub>	-	-0.3	V <sub>DD</sub> +0.3	V
Operating Temperature	T <sub>OP</sub>	-	-20	70	°C
Storage Temperature	T <sub>ST</sub>	-	-30	80	°C
Storage Humidity	H <sub>D</sub>	T <sub>a</sub> < 40 °C	-	90	%RH

### 1.4 DC Electrical Characteristics

T<sub>a</sub> = 25°C

Item	Symbol	Condition	Min.	Typ.	Max.	Unit
Logic Supply Voltage	V <sub>DD</sub>	-	4.5	5.0	5.5	V
“H” Input Voltage	V <sub>IH</sub>	-	0.7 V <sub>DD</sub>	-	V <sub>DD</sub>	V
“L” Input Voltage	V <sub>IL</sub>	-	-0.3	-	0.6	V
“H” Output Voltage	V <sub>OH</sub>	I <sub>OH</sub> =-0.1mA	3.9	-	V <sub>DD</sub>	V
“L” Output Voltage	V <sub>OL</sub>	I <sub>OL</sub> =0.1mA	-	-	0.4	V
Supply Current	I <sub>dd</sub>	V <sub>DD</sub> = 5.0 V , V <sub>o</sub> = 0.8 V	-	6	8	mA
Vo Driver Voltage	V <sub>o</sub>	-20°C (V <sub>DD</sub> = 5.0 V)	1.0	0.8	0.6	V
		25°C (V <sub>DD</sub> = 5.0 V)	1.0	0.8	0.6	
		70°C (V <sub>DD</sub> = 5.0 V)	1.0	0.8	0.6	

## 1.5 Optical Characteristics

LCD Panel : 1/16 Duty , 1/5 Bias ,  $V_{LCD} = 8.3 V$  ,  $T_a = 25^{\circ}C$

Item	Symbol	Conditions	Min.	Typ.	Max.	Unit	Reference
Response Time	Rise	tr	-	70	105	ms	Note2
	Fall	tf	-	30	45		
Viewing angle range	Top	$\theta Y+$	-	60	-	Deg.	Notes 1
	Bottom	$\theta Y-$	-	60	-		
	Left	$\theta X-$	-	60	-		
	Right	$\theta X+$	-	60	-		
Contrast Ratio	C	$\theta = 0^{\circ}$	-	118	-	-	Note 3
Average Brightness (BL & LCD) *2	IV	IF=40 mA	30	40	-	cd/m <sup>2</sup>	Note 4
CIE Color Coordinate (BL & LCD) *2	X		0.22	0.27	0.32		
	Y		0.19	0.24	0.29		
Uniformity *1	$\Delta B$	IF=40 mA	70	-	-	%	

Note 4 :

1 :  $\Delta B = B(\min) / B(\max) * 100\%$

2 : Measurement Condition for Optical Characteristics:

a : Environment:  $25^{\circ}C \pm 5^{\circ}C$  /  $60 \pm 20\% R.H$  , no wind , dark room below 10 Lux at typical lamp current and typical operating frequency.

b : Measurement Distance:  $500 \pm 50 \text{ mm}$  , ( $\theta = 0^{\circ}$ )

c : Equipment: TOPCON BM-7 fast , (field  $1^{\circ}$ ) , after 10 minutes operation.

d : The uncertainty of the C.I.E coordinate measurement  $\pm 0.01$  , Average Brightness  $\pm 4\%$

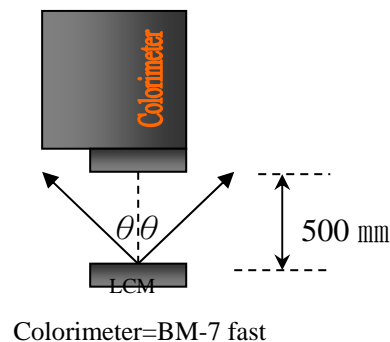
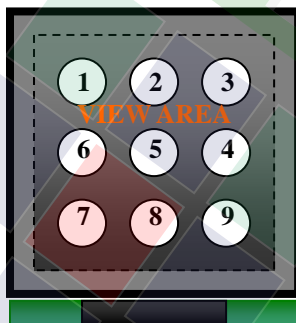

Note 1.

Optical characteristics-2

Viewing angle

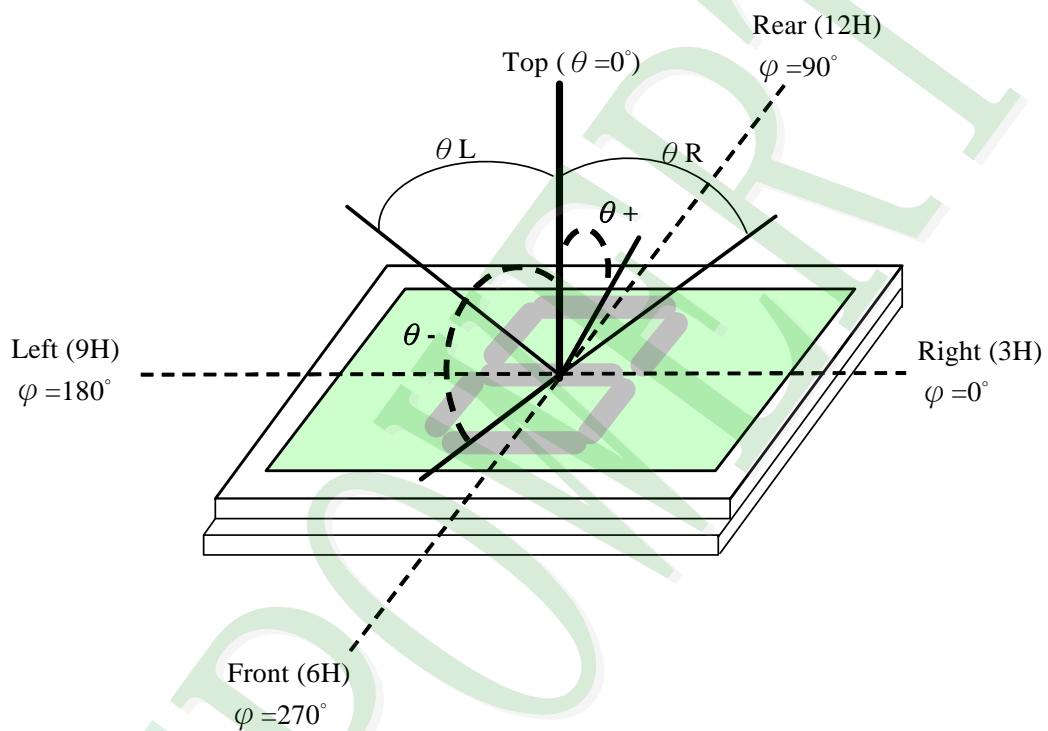

**Viewing angle**

Note 2.

Optical characteristics-3

Fig.2 Definition of response time

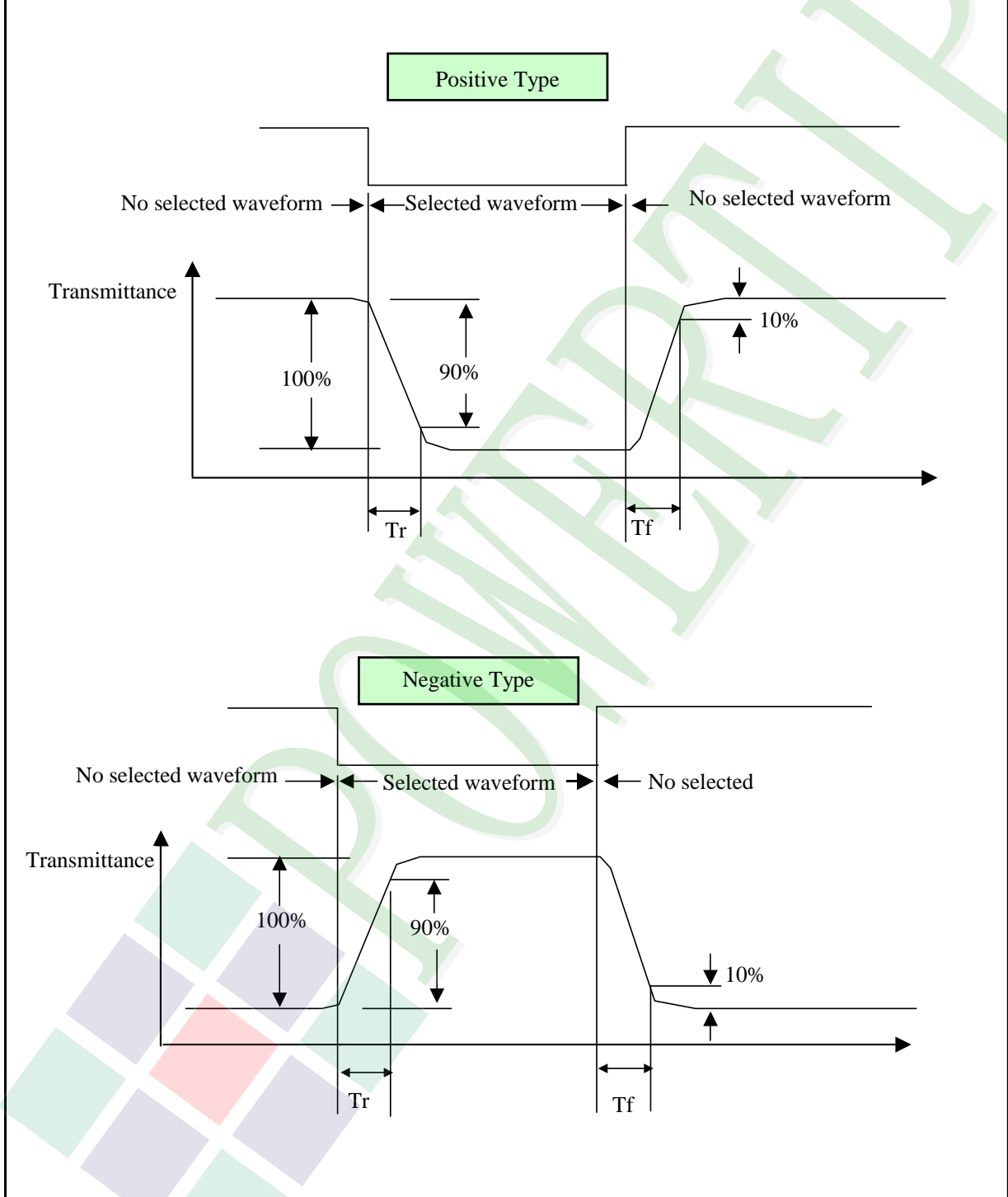



Electrical characteristics-2

※2 Drive waveform

$V_{op}$ : Drive voltage

$f_F$ : Frame frequency

$1/B$ : Bias

$f_D$ : Drive frequency

$N$ : Duty

(1) Selected waveform

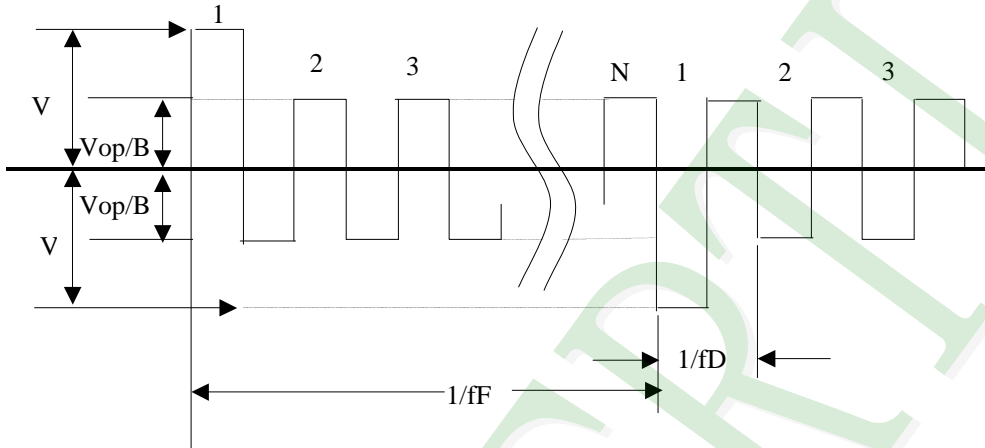

(2) Non- Selected wave form

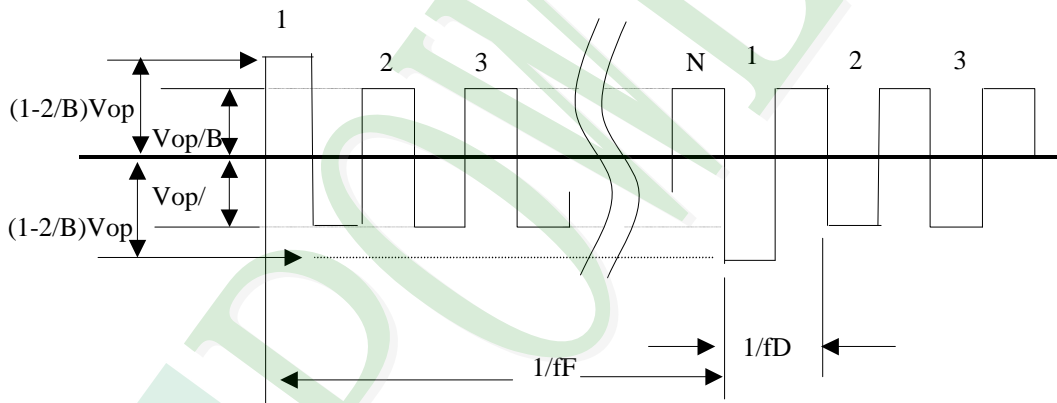

Note:

Frame frequency is defined as follows: Common side supply voltage peak - to - peak / 2 = 1 period

Note 3. : Definition of Vth

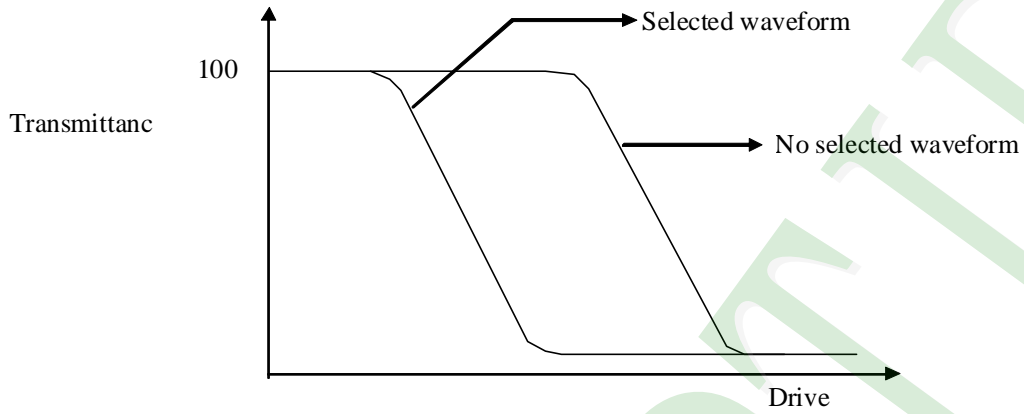

※1 Contrast ratio  
= (Brightness in OFF state) / (Brightness in ON state)

Outline of Electro-Optical Characteristics Measuring System

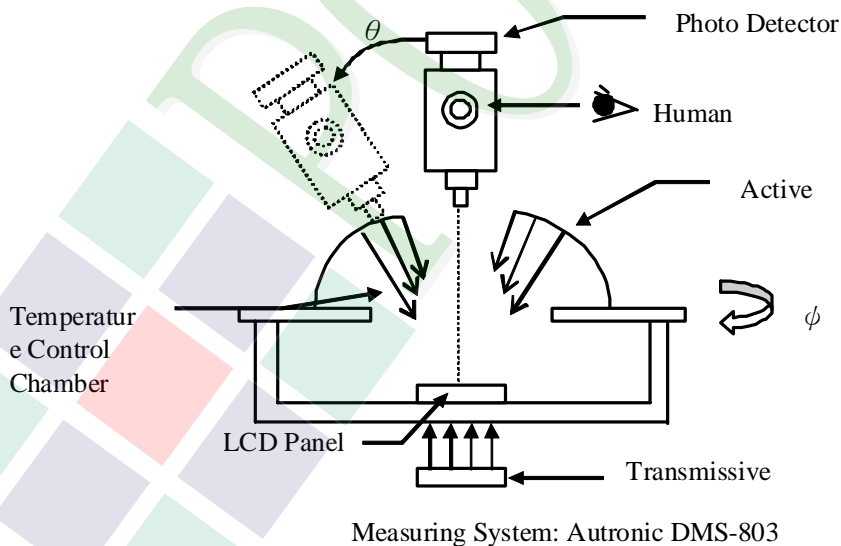

## 1.6 Backlight Characteristics

LED Backlight

Maximum Ratings

Item	Symbol	Conditions	Min.	Max.	Unit
Forward Current	IF	Ta =25°C	-	40	mA
Reverse Voltage	VR	Ta =25°C	-	5	V
Power Dissipation	PD	Ta =25°C	-	132	mW

Electrical / Optical Characteristics

Item	Symbol	Conditions	Min.	Typ.	Max.	Unit
Forward Voltage	VF	IF= 40 mA	3.0	3.3	3.6	V
Average Brightness (without LCD)	IV		1200	1500	-	cd/m <sup>2</sup>
CIE Color Coordinate (Without LCD)	X		0.26	0.29	0.31	
	Y		0.26	0.29	0.31	
Color		White				

Internal Circuit Diagram:

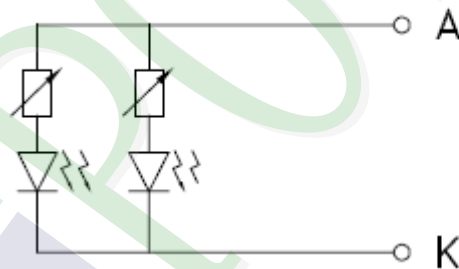

## 2. MODULE STRUCTURE

### 2.1 Counter Drawing

#### 2.1.1 LCM Mechanical Diagram

\* See Appendix

#### 2.1.2 Block Diagram

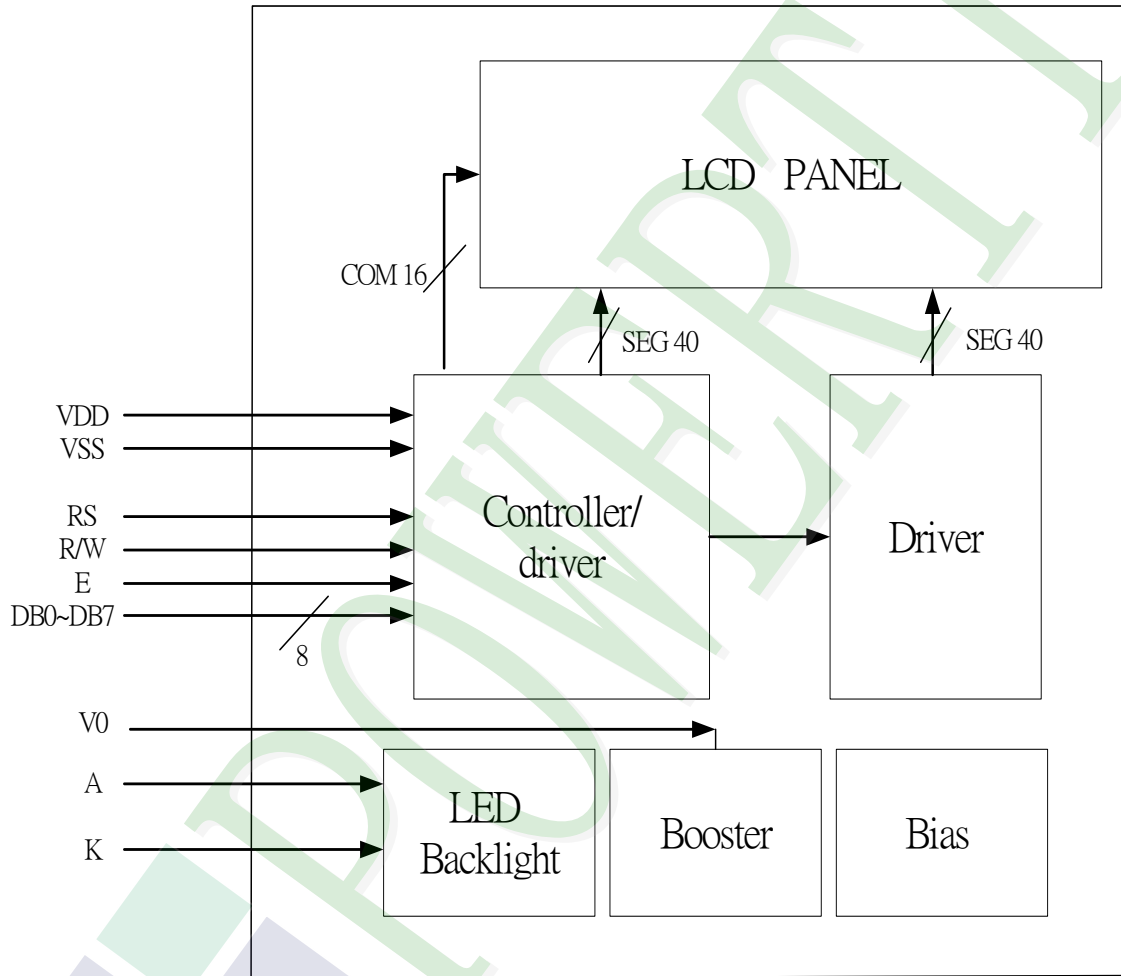

## 2.2 Interface Pin Description

Pin No.	Symbol	Signal Description
1	V <sub>SS</sub>	Power Supply (V <sub>SS</sub> =0)
2	V <sub>DD</sub>	Power Supply (5V)
3	V <sub>O</sub>	Operating voltage for LCD
4	RS	Register Selection input High = Data register Low = Instruction register (for write) Busy flag address counter (for read)
5	R/W	Read/Write signal input is used to select the read/write mode High = Read mode, Low = Write mode
6	E	Start enable signal to read or write the data
7	DB0	Four low order bi-directional three-state data bus lines. Use for data transfer between the MPU and the LCD module. These four are not used during 4-bit operation.
8	DB1	
9	DB2	
10	DB3	
11	DB4	Four high order bi-directional three-state data bus lines. Used for data transfer between the MPU and the LCD module. DB7 can be used as a busy flag.
12	DB5	
13	DB6	
14	DB7	
15	A	LED+
16	K	LED-

### Contrast Adjust



## 2.3 Timing Characteristics

- Writing data from MPU to ST7066U

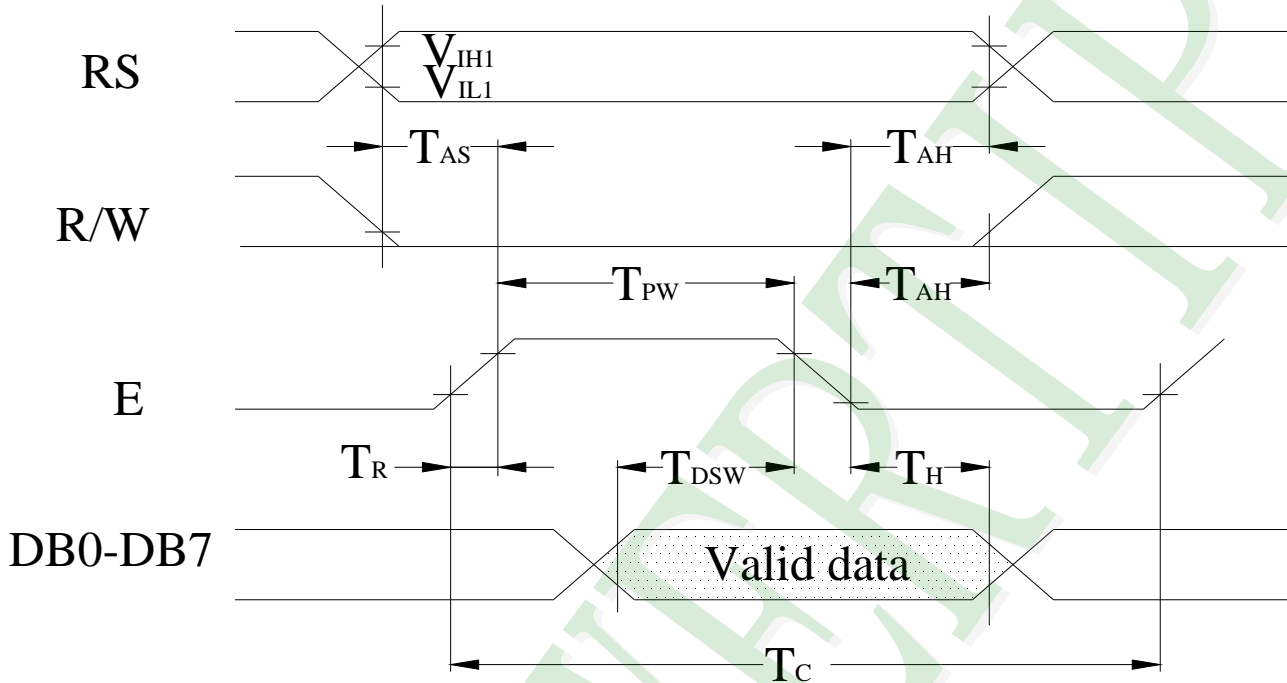

- Reading data from ST7066U to MPU

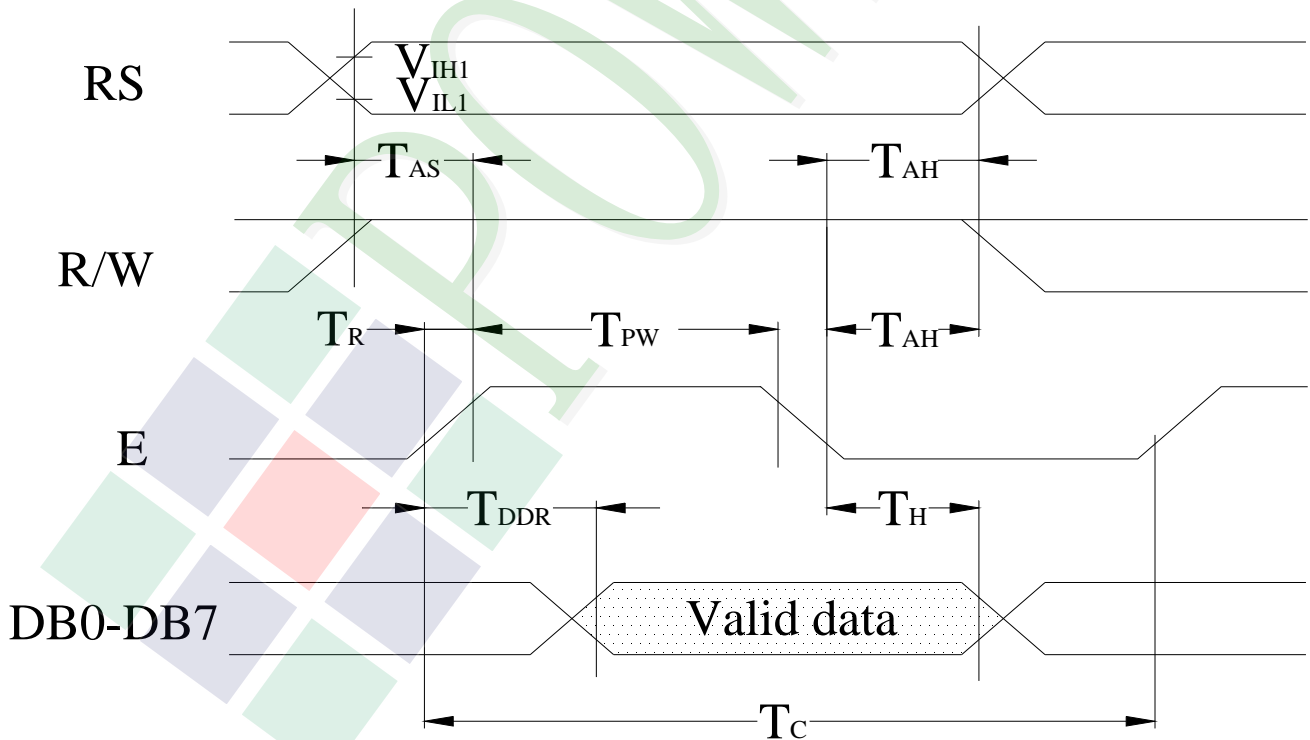

• Write Mode (Writing data from MPU to ST7066U)

(VDD = 5V, Ta=25°C)

Symbol	Characteristics	Test Condition	Min.	Typ.	Max.	Unit
T <sub>C</sub>	Enable Cycle Time	Pin E	1200	-	-	ns
T <sub>PW</sub>	Enable Pulse Width	Pin E	140	-	-	ns
T <sub>R</sub> , T <sub>F</sub>	Enable Rise / Fall Time	Pin E	-	-	25	ns
T <sub>AS</sub>	Address Setup Time	Pins: RS , RW,E	0	-	-	ns
T <sub>AH</sub>	Address Hold Time	Pins :RS,RW,E	10	-	-	ns
T <sub>D<sub>SW</sub></sub>	Data Setup Time	Pins:DB0~DB7	40	-	-	ns
T <sub>H</sub>	Data Hold Time	Pins:DB0~DB7	10	-	-	ns

• Read Mode (Reading data from ST7066U to MPU)

(VDD = 5V, Ta=25°C)

Symbol	Characteristics	Test Condition	Min.	Typ.	Max.	Unit
T <sub>C</sub>	Enable Cycle Time	Pin E	1200	-	-	ns
T <sub>PW</sub>	Enable Pulse Width	Pin E	140	-	-	ns
T <sub>R</sub> , T <sub>F</sub>	Enable Rise / Fall Time	Pin E	-	-	25	ns
T <sub>AS</sub>	Address Setup Time	Pins: RS , RW,E	0	-	-	ns
T <sub>AH</sub>	Address Hold Time	Pins :RS,RW,E	10	-	-	ns
T <sub>DDR</sub>	Data Setup Time	Pins:DB0~DB7	-	-	100	ns
T <sub>H</sub>	Data Hold Time	Pins:DB0~DB7	10	-	-	ns

For 4-bit interface date, only four bus lines (DB4 to DB7) are used for transfer.

Example of busy flag check timing sequence

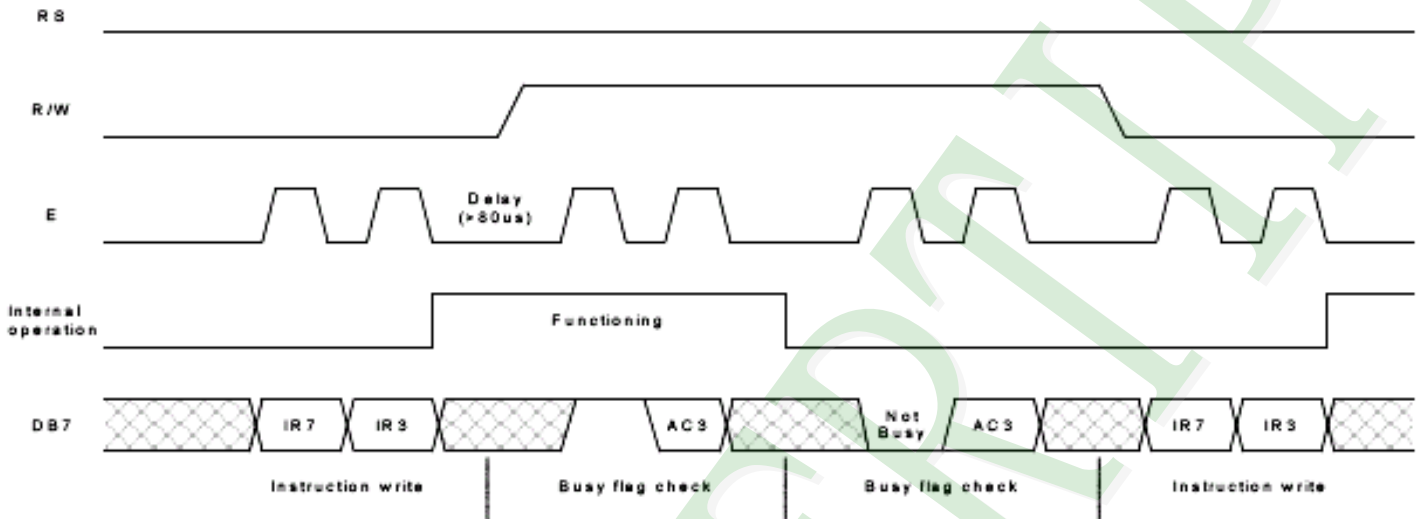

For 8-bit interface date, all eight bus lines (DB0 to DB7) are used .

Example of busy flag check timing sequence

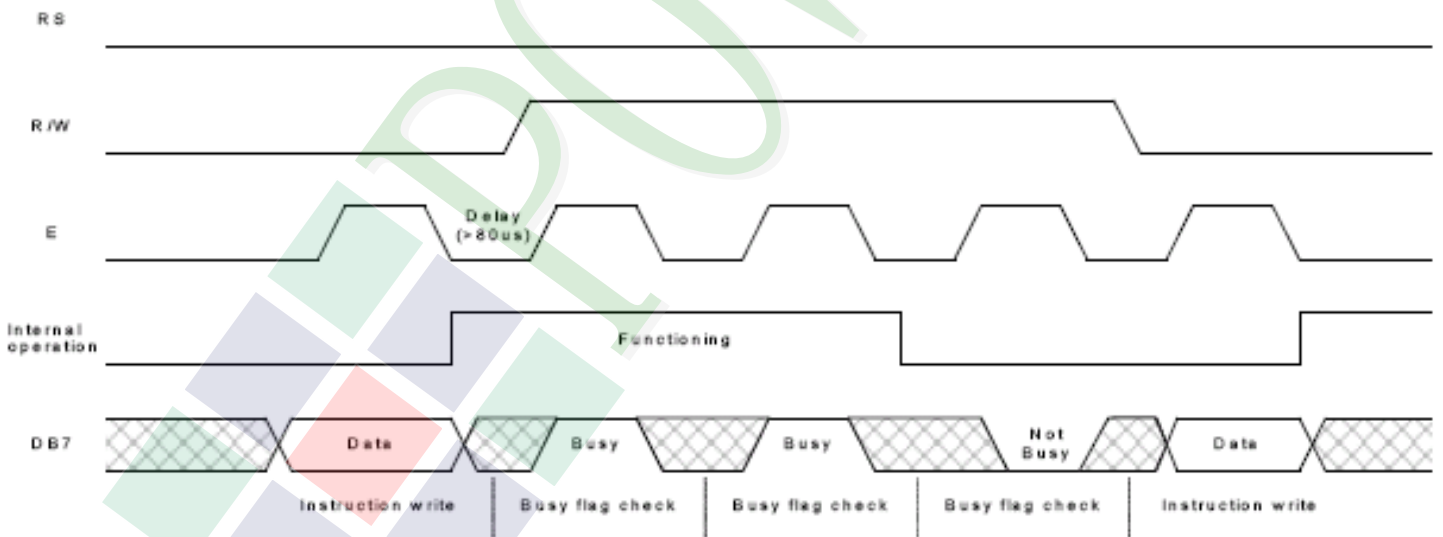



## 2.4 Display Command

Instructions	Instruction Code										Description	Description Time (270KHz)	
	RS	R/W	DB 7	DB 6	DB 5	DB 4	DB 3	DB 2	DB 1	DB 0			
Clear Display	0	0	0	0	0	0	0	0	0	0	1	Write "20H" to DDRAM. and set DDRAM address to "00H" from AC.	1.52ms
Return Home	0	0	0	0	0	0	0	0	0	1	×	Set DDRAM address to "00H" from AC and return cursor to it's original position if shifted. The contents of DDRAM are not changed.	1.52ms
Entry Mode Set	0	0	0	0	0	0	0	0	1	I/D	S	Sets cursor move direction and specifies display shift. These operations are performed during data write and read .	37μs
Display ON/OFF	0	0	0	0	0	0	0	1	D	C	B	D=1 : entire display on C=1 : cursor on B=1 : cursor position on	37μs
Cursor or Display Shift	0	0	0	0	0	0	1	S/C	R/L	×	×	Set cursor moving and display shift control bit, and the the direction, without changing of DDRAM data.	37μs
Function Set	0	0	0	0	0	1	DL	N	F	×	×	DL: interface data is 8/4 bits NL: number of line is 2/1 F: font size is 5×11/5×8	37μs
Set CGRAM Address	0	0	0	1	AC 5	AC 4	AC 3	AC 2	AC 1	AC 0		Set CGRAM address in address counter.	37μs
Set DDRAM Address	0	0	1	AC 6	AC 5	AC 4	AC 3	AC 2	AC 1	AC 0		Set DDRAM address in address counter.	37μs
Read Busy Flag and Address	0	1	B F	AC 6	AC 5	AC 4	AC 3	AC 2	AC 1	AC 0		Whether during internal operation or not can be known by reading BF. The contents of address counter can also be read.	0μs

Write Data to RAM	1	0	D7	D6	D5	D4	D3	D2	D1	D0	Write data into internal RAM (DDRAM/CGRAM).	37 $\mu$ s
Read Data from RAM	1	1	D7	D6	D5	D4	D3	D2	D1	D0	Read data from internal RAM (DDRAM/CGRAM).	37 $\mu$ s

Note:

Be sure the ST7066U is not in the busy state (BF=0) before sending an instruction from the MPU to the ST7066.

If an instruction is sent without checking the busy flag , the time between the first instruction and next instruction will take much longer than the instruction time itself.

Before checking BF, be sure to wait at least 80us.. Do not keep "E" always "High" for checking BF

Refer to Instruction Table for the list of each instruction execution time .

### 2.4.1 Reference initial code

```

START: CLR  L_E
      CALL LCDRE           ;LCM reset by software
      MOV  A,#00111000B   ;8bit drive,2line mode,5x8word
      CALL WIR
START1: MOV  A,#00001100B ;display on,cursor off
      CALL WIR
      MOV  A,#00000110B   ;address add
      CALL WIR
      MOV  A,#00000010B   ;cursor home
      CALL WIR
      MOV  A,#00000001B   ;clean display,cursor home
      CALL WIR
      MOV  A,#01000000B   ;set CGRAM start address
      CALL WIR
  
```

## 2.5 Character Pattern

### ST7066-0T

b7-b4 b3-b0	0000	0001	0010	0011	0100	0101	0110	0111	1000	1001	1010	1011	1100	1101	1110	1111
0000	CG FAM (1)			0	0	P	P				0	0	N	.	0	0
0001	(2)		1	1	0	0	a	a			1	1	u	.	1	1
0010	(3)		2	2	0	0	r	r			2	2	e	.	2	2
0011	(4)		3	3	0	0	s	s			3	3	u	.	3	3
0100	(5)		4	4	0	0	t	t			4	4	e	.	4	4
0101	(6)		5	5	0	0	u	u			5	5	e	.	5	5
0110	(7)		6	6	0	0	v	v			6	6	e	.	6	6
0111	(8)		7	7	0	0	w	w			7	7	e	.	7	7
1000	(1)		8	8	0	0	x	x			8	8	e	.	8	8
1001	(2)		9	9	0	0	y	y			9	9	e	.	9	9
1010	(3)		*	*	0	0	z	z			0	0	e	.	0	0
1011	(4)		+	+	0	0	[	[			1	1	e	.	1	1
1100	(5)		^	^	0	0	]	]			2	2	e	.	2	2
1101	(6)		_	_	0	0	~	~			3	3	e	.	3	3
1110	(7)		~	~	0	0	^	^			4	4	e	.	4	4
1111	(8)		/	/	0	0	e	e			5	5	e	.	5	5

## 2.6 JUMPER(Setting different use)

J1,J3,J5 :SHORT;

Others :open

### 3. QUALITY ASSURANCE SYSTEM

#### 3.1 Quality Assurance Flow Chart

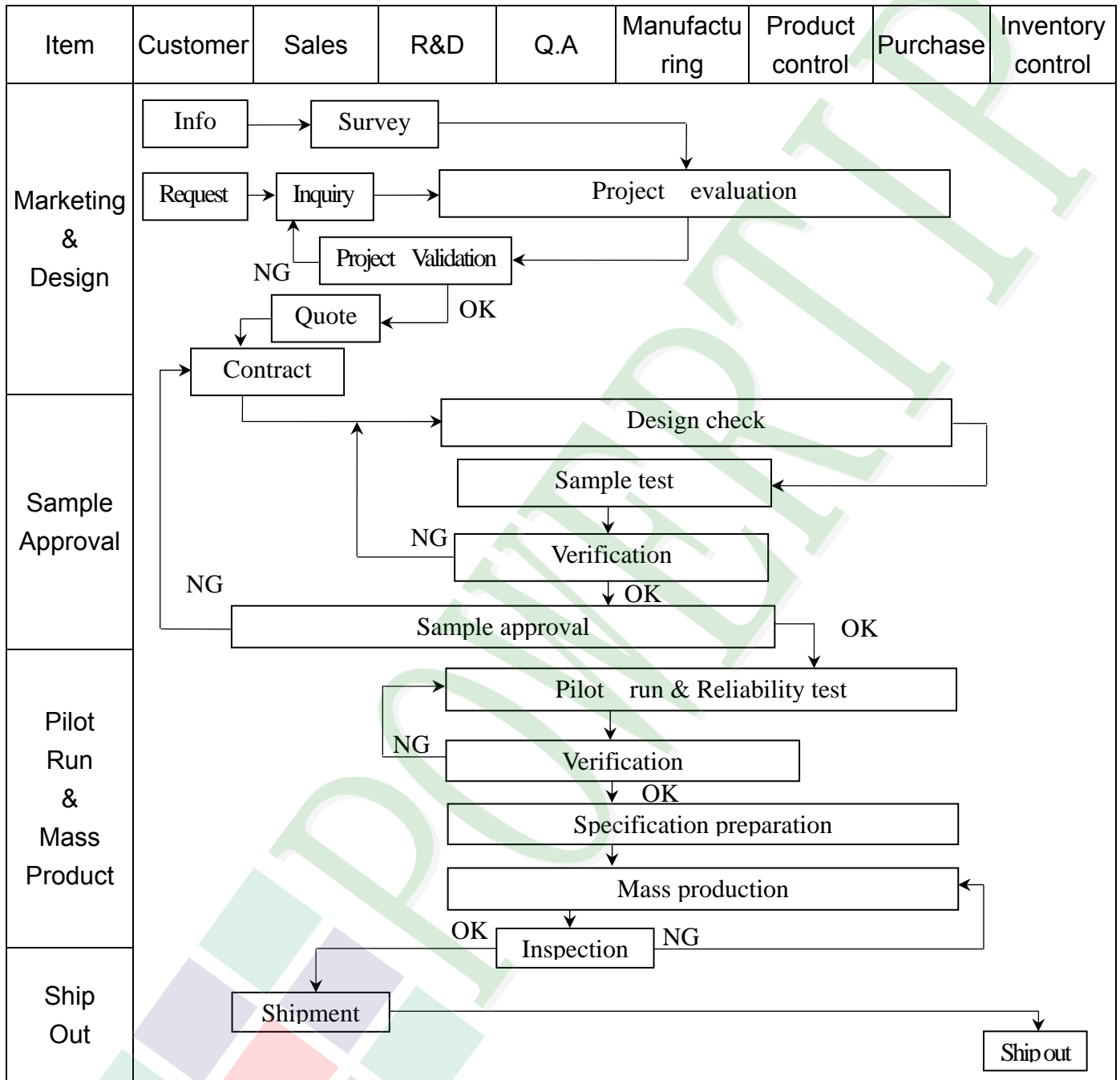

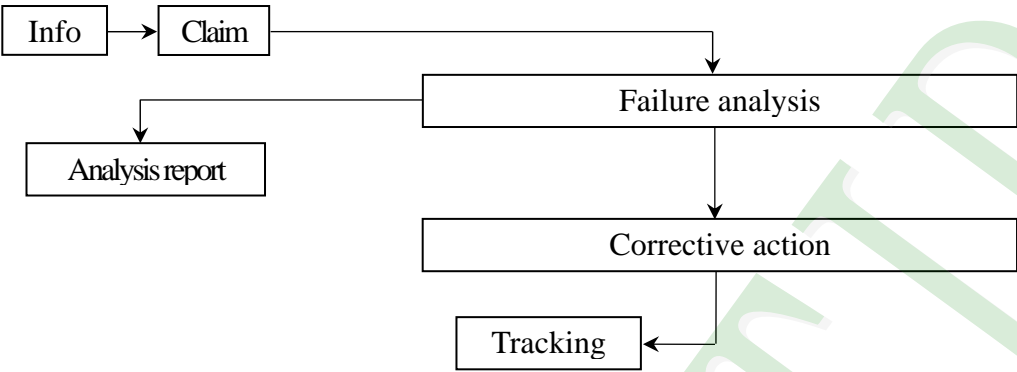
Item	Customer	Sales	R&D	Q.A	Manufacturing	Product control	Purchase	Inventory control
Sales Service	 <pre> graph TD     Info[Info] --&gt; Claim[Claim]     Claim --&gt; FA[Failure analysis]     Claim --&gt; AR[Analysis report]     FA --&gt; CA[Corrective action]     CA --&gt; Tracking[Tracking]         </pre>							
Q.A Activity	1. ISO 9001 Maintenance Activities 3. Equipment calibration 5. Standardization Management				2. Process improvement proposal 4. Education And Training Activities			

## 3.2 Inspection Specification

◆Scope : The document shall be applied to LCD Module for Monotype and Color STN(Ver. B01).

◆Inspection Standard : MIL-STD-105E Table Normal Inspection Single Sampling Level II .

(100% tested before shipment)

◆Equipment : Gauge 、 MIL-STD 、 Powertip Tester 、 Sample

◆Defect Level : Major Defect AQL : 0.4 ; Minor Defect : AQL : 1.5 .

◆OUT Going Defect Level : Sampling .

◆Manner of appearance test :

(1). The test be under 20W×2 fluorescent light ' and distance of view must be at 30 cm.

(2). Standard of inspection : (Unit : mm)

(3). The test direction is base on about around 45° of vertical line. (Fig. 1)

(4). Definition of area . (Fig. 2)

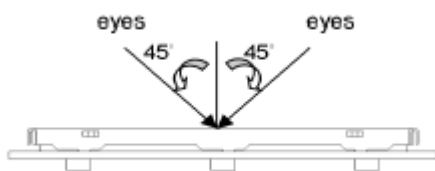

Fig.1

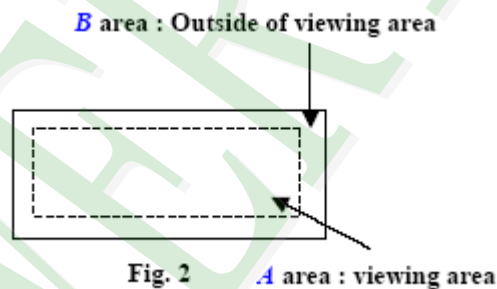
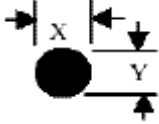
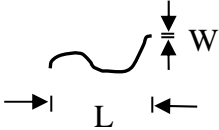
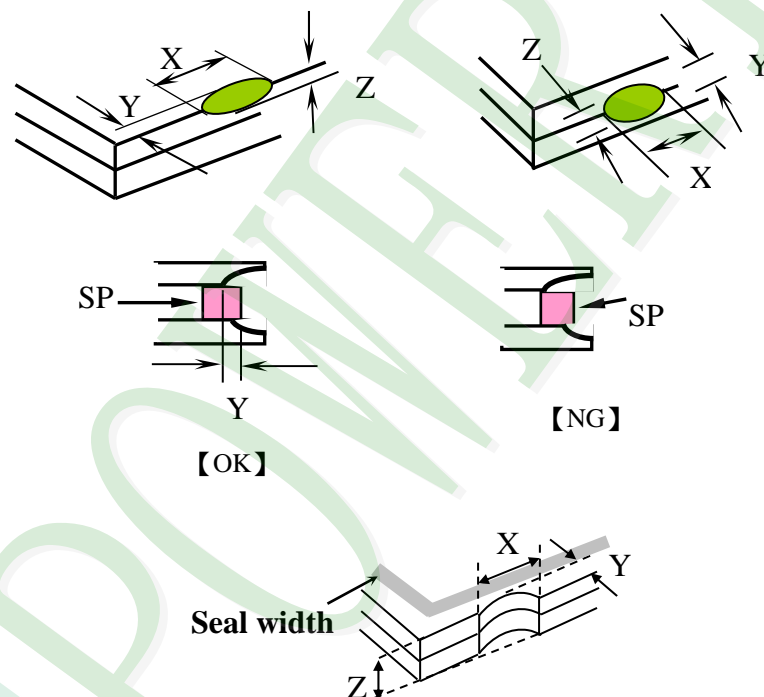

Fig. 2

◆ Specification:

NO	Item	Criterion	Level
01	Product condition	1. 1 The part number is inconsistent with work order of Production.	Major
		1. 2 Mixed production types.	Major
		1. 3 Assembled in inverse direction.	Major
02	Quantity	2. 1 The quantity is inconsistent with work order of production.	Major
03	Outline dimension	3. 1 Product dimension and structure must conform to Structure diagram.	Major
04	Electrical Testing	4. 1 Missing line character and icon.	Major
		4. 2 No function or no display.	Major
		4. 3 Output data is error.	Major
		4. 4 LCD viewing angle defect.	Major
		4. 5 Current consumption exceeds product specifications.	Major

NO	Item	Criterion	Level																																					
05	<p>Black or white dot、scratch、contamination</p> <p>Round type</p>  <p><math>\Phi = (x+y)/2</math></p> <p>Line type</p> 	<p>5. 1 Round type:</p> <p>5. 1. 1 display only :</p> <ul style="list-style-type: none"> <li>• White and black spots on display <math>\leq 0.30</math> mm , no more than 4 white or black spots present.</li> <li>• Densely spaced : NO more than two spots or lines within 3 mm.</li> </ul> <p>5. 1. 2 Non-display :</p> <table border="1" data-bbox="485 696 1342 1043"> <thead> <tr> <th rowspan="2">Dimension (diameter : <math>\Phi</math>)</th> <th colspan="2">Acceptance (Q'ty)</th> </tr> <tr> <th>A area</th> <th>B area</th> </tr> </thead> <tbody> <tr> <td><math>\Phi \leq 0.10</math></td> <td colspan="2">Accept no dense</td> </tr> <tr> <td><math>0.10 &lt; \Phi \leq 0.20</math></td> <td>3</td> <td rowspan="2">Ignore</td> </tr> <tr> <td><math>0.20 &lt; \Phi \leq 0.30</math></td> <td>2</td> </tr> <tr> <td><b>Total quantity</b></td> <td colspan="2"><b>4</b></td> </tr> </tbody> </table> <p>5. 1. 3 Line type:</p> <table border="1" data-bbox="437 1122 1390 1462"> <thead> <tr> <th colspan="2">Dimension</th> <th colspan="2">Acceptance (Q'ty)</th> </tr> <tr> <th>Length (L)</th> <th>Width (W)</th> <th>A area</th> <th>B area</th> </tr> </thead> <tbody> <tr> <td>---</td> <td><math>W \leq 0.03</math></td> <td>Accept no dense</td> <td rowspan="3">Ignore</td> </tr> <tr> <td><math>L \leq 3.0</math></td> <td><math>0.03 &lt; W \leq 0.05</math></td> <td rowspan="2">4</td> </tr> <tr> <td><math>L \leq 2.5</math></td> <td><math>0.05 &lt; W \leq 0.075</math></td> </tr> <tr> <td>---</td> <td><math>W &gt; 0.075</math></td> <td colspan="2">As round type</td> </tr> </tbody> </table>	Dimension (diameter : $\Phi$ )	Acceptance (Q'ty)		A area	B area	$\Phi \leq 0.10$	Accept no dense		$0.10 < \Phi \leq 0.20$	3	Ignore	$0.20 < \Phi \leq 0.30$	2	<b>Total quantity</b>	<b>4</b>		Dimension		Acceptance (Q'ty)		Length (L)	Width (W)	A area	B area	---	$W \leq 0.03$	Accept no dense	Ignore	$L \leq 3.0$	$0.03 < W \leq 0.05$	4	$L \leq 2.5$	$0.05 < W \leq 0.075$	---	$W > 0.075$	As round type		Minor
Dimension (diameter : $\Phi$ )	Acceptance (Q'ty)																																							
	A area	B area																																						
$\Phi \leq 0.10$	Accept no dense																																							
$0.10 < \Phi \leq 0.20$	3	Ignore																																						
$0.20 < \Phi \leq 0.30$	2																																							
<b>Total quantity</b>	<b>4</b>																																							
Dimension		Acceptance (Q'ty)																																						
Length (L)	Width (W)	A area	B area																																					
---	$W \leq 0.03$	Accept no dense	Ignore																																					
$L \leq 3.0$	$0.03 < W \leq 0.05$	4																																						
$L \leq 2.5$	$0.05 < W \leq 0.075$																																							
---	$W > 0.075$	As round type																																						
06	Polarizer Bubble	<table border="1" data-bbox="440 1525 1386 1917"> <thead> <tr> <th rowspan="2">Dimension (diameter : <math>\Phi</math>)</th> <th colspan="2">Acceptance (Q'ty)</th> </tr> <tr> <th>A area</th> <th>B area</th> </tr> </thead> <tbody> <tr> <td><math>\Phi \leq 0.20</math></td> <td colspan="2">Accept no dense</td> </tr> <tr> <td><math>0.20 &lt; \Phi \leq 0.50</math></td> <td>3</td> <td rowspan="3">Ignore</td> </tr> <tr> <td><math>0.50 &lt; \Phi \leq 1.00</math></td> <td>2</td> </tr> <tr> <td><math>\Phi &gt; 1.00</math></td> <td>0</td> </tr> <tr> <td><b>Total quantity</b></td> <td colspan="2"><b>4</b></td> </tr> </tbody> </table>	Dimension (diameter : $\Phi$ )	Acceptance (Q'ty)		A area	B area	$\Phi \leq 0.20$	Accept no dense		$0.20 < \Phi \leq 0.50$	3	Ignore	$0.50 < \Phi \leq 1.00$	2	$\Phi > 1.00$	0	<b>Total quantity</b>	<b>4</b>		Minor																			
Dimension (diameter : $\Phi$ )	Acceptance (Q'ty)																																							
	A area	B area																																						
$\Phi \leq 0.20$	Accept no dense																																							
$0.20 < \Phi \leq 0.50$	3	Ignore																																						
$0.50 < \Phi \leq 1.00$	2																																							
$\Phi > 1.00$	0																																							
<b>Total quantity</b>	<b>4</b>																																							

NO	Item	Criterion	Level						
07	The crack of glass	<p><b>Symbols :</b></p> <p><b>X : The length of crack</b>                      <b>Y : The width of crack.</b>  <b>Z : The thickness of crack</b>                <b>W : terminal length</b>  <b>t : The thickness of glass</b>                 <b>a : LCD side length</b></p> <hr/> <p>7.1 General glass chip :  7.1.1 Chip on panel surface and crack between panels:</p> 	Minor						
		<table border="1" data-bbox="502 1545 1316 1836"> <thead> <tr> <th>X</th> <th>Y</th> <th>Z</th> </tr> </thead> <tbody> <tr> <td><math>\leq a</math></td> <td>Crack can't enter viewing area</td> <td><math>\leq 1/2 t</math></td> </tr> <tr> <td><math>\leq a</math></td> <td>Crack can't exceed the half of SP width.</td> <td><math>1/2 t &lt; Z \leq 2 t</math></td> </tr> </tbody> </table>		X	Y	Z	$\leq a$	Crack can't enter viewing area	$\leq 1/2 t$
X	Y	Z							
$\leq a$	Crack can't enter viewing area	$\leq 1/2 t$							
$\leq a$	Crack can't exceed the half of SP width.	$1/2 t < Z \leq 2 t$							

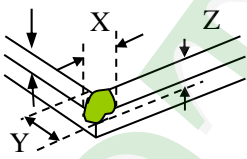
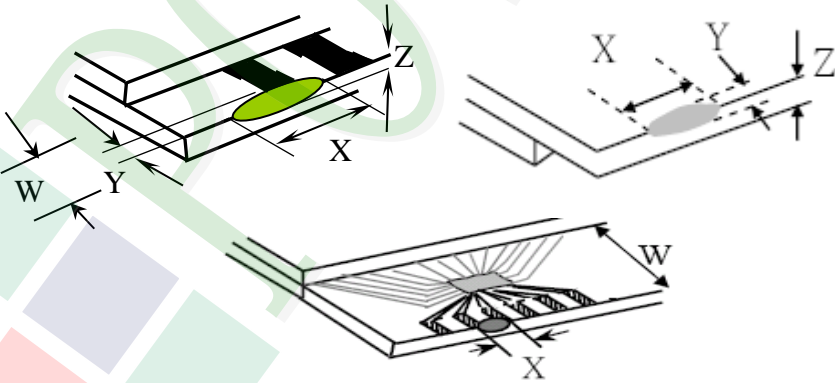

NO	Item	Criterion	Level										
07	The crack of glass	<p><b>Symbols :</b></p> <p><b>X :</b> The length of crack  <b>Z :</b> The thickness of crack  <b>t :</b> The thickness of glass</p> <p><b>Y :</b> The width of crack.  <b>W :</b> terminal length  <b>a :</b> LCD side length</p> <hr/> <p>7.1.2 Corner crack :</p>  <table border="1" data-bbox="502 828 1316 1131"> <thead> <tr> <th>X</th> <th>Y</th> <th>Z</th> </tr> </thead> <tbody> <tr> <td><math>\leq 1/5 a</math></td> <td>Crack can't enter viewing area</td> <td><math>Z \leq 1/2 t</math></td> </tr> <tr> <td><math>\leq 1/5 a</math></td> <td>Crack can't exceed the half of SP width.</td> <td><math>1/2 t &lt; Z \leq 2 t</math></td> </tr> </tbody> </table>	X	Y	Z	$\leq 1/5 a$	Crack can't enter viewing area	$Z \leq 1/2 t$	$\leq 1/5 a$	Crack can't exceed the half of SP width.	$1/2 t < Z \leq 2 t$	Minor	
		X	Y	Z									
$\leq 1/5 a$	Crack can't enter viewing area	$Z \leq 1/2 t$											
$\leq 1/5 a$	Crack can't exceed the half of SP width.	$1/2 t < Z \leq 2 t$											
<p>7.2 Protrusion over terminal :</p> <p>7.2.1 Chip on electrode pad :</p>  <table border="1" data-bbox="470 1713 1252 1881"> <thead> <tr> <th></th> <th>X</th> <th>Y</th> <th>Z</th> </tr> </thead> <tbody> <tr> <td>Front</td> <td><math>\leq a</math></td> <td><math>\leq 1/2 W</math></td> <td><math>\leq t</math></td> </tr> <tr> <td>Back</td> <td colspan="3">Neglect</td> </tr> </tbody> </table>		X	Y	Z	Front	$\leq a$	$\leq 1/2 W$	$\leq t$	Back	Neglect			
	X	Y	Z										
Front	$\leq a$	$\leq 1/2 W$	$\leq t$										
Back	Neglect												

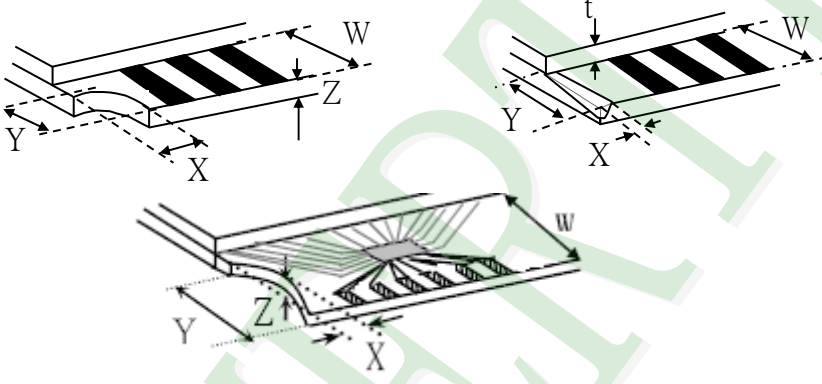
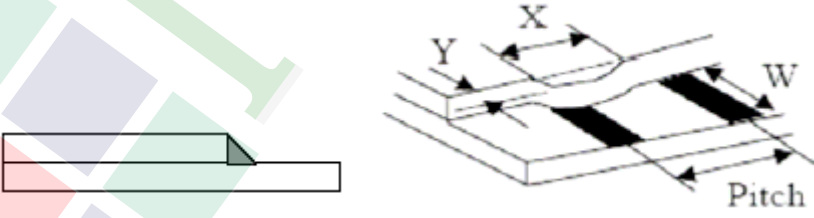
NO	Item	Criterion	Level									
07	The crack of glass	<p><b>Symbols :</b></p> <p><b>X : The length of crack</b>                      <b>Y : The width of crack.</b>  <b>Z : The thickness of crack</b>                      <b>W : terminal length</b>  <b>t : The thickness of glass</b>                      <b>a : LCD side length</b></p>	Minor									
		<p><b>7.2.2 Non-conductive portion :</b></p>  <table border="1" data-bbox="582 1070 1209 1227"> <thead> <tr> <th>X</th> <th>Y</th> <th>Z</th> </tr> </thead> <tbody> <tr> <td><math>\leq 1/3 a</math></td> <td><math>\leq W</math></td> <td><math>\leq t</math></td> </tr> </tbody> </table> <p>⊙ If the chipped area touches the ITO terminal, over 2/3 of the ITO must remain and be inspected according to electrode terminal specifications.</p> <p><b>7.2.3 Glass remain :</b></p>  <table border="1" data-bbox="502 1758 1193 1899"> <thead> <tr> <th>X</th> <th>Y</th> <th>Z</th> </tr> </thead> <tbody> <tr> <td><math>\leq a</math></td> <td><math>\leq 1/3 W</math></td> <td><math>\leq t</math></td> </tr> </tbody> </table>		X	Y	Z	$\leq 1/3 a$	$\leq W$	$\leq t$	X	Y	Z
X	Y	Z										
$\leq 1/3 a$	$\leq W$	$\leq t$										
X	Y	Z										
$\leq a$	$\leq 1/3 W$	$\leq t$										

NO	Item	Criterion	Level
08	Backlight elements	8. 1 Backlight can't work normally.	Major
		8. 2 Backlight doesn't light or color is wrong.	Major
		8. 3 Illumination source flickers when lit.	Major
09	General appearance	9. 1 Pin type must match type in specification sheet.	Major
		9. 2 No short circuits in components on PCB or FPC.	Major
		9. 3 Product packaging must the same as specified on packaging specification sheet.	Minor
		9. 4 The folding and peeled off in polarizer are not acceptable.	Minor
		9. 5 The PCB or FPC between B/L assembled distance (PCB or FPC) is $\leq 1.5$ mm.	Minor



## 5. PRECAUTION RELATING PRODUCT HANDLING

### 5.1 SAFETY

- 5.1.1 If the LCD panel breaks , be careful not to get the liquid crystal to touch your skin.
- 5.1.2 If the liquid crystal touches your skin or clothes , please wash it off immediately by using soap and water.

### 5.2 HANDLING

- 5.2.1 Avoid any strong mechanical shock which can break the glass.
- 5.2.2 Avoid static electricity which can damage the CMOS LSI—When working with the module , be sure to ground your body and any electrical equipment you may be using.
- 5.2.3 Do not remove the panel or frame from the module.
- 5.2.4 The polarizing plate of the display is very fragile. So , please handle it very carefully ,do not touch , push or rub the exposed polarizing with anything harder than an HB pencil lead (glass , tweezers , etc.)
- 5.2.5 Do not wipe the polarizing plate with a dry cloth , as it may easily scratch the surface of plate.
- 5.2.6 Do not touch the display area with bare hands , this will stain the display area.
- 5.2.7 Do not use ketonics solvent & aromatic solvent. Use with a soft cloth soaked with a cleaning naphtha solvent.
- 5.2.8 To control temperature and time of soldering is  $320\pm 10^{\circ}\text{C}$  and 3-5 sec.
- 5.2.9 To avoid liquid (include organic solvent) stained on LCM .
- 5.2.10 Caution!( LCM products with Capacitive Touch Panel)  
Strong EMI-sources such as switch-mode power supplies (SMPS) can lead to touch malfunction (e.g. ghost-touches).  
Therefore, the touch needs to be thoroughly tested inside the target application.

### 5.3 STORAGE

- 5.3.1 Store the panel or module in a dark place where the temperature is  $25^{\circ}\text{C} \pm 5^{\circ}\text{C}$  and the humidity is below 65% RH.
- 5.3.2 Do not place the module near organics solvents or corrosive gases.
- 5.3.3 Do not crush , shake , or jolt the module.

### 5.4 TERMS OF WARRANTY

- 5.4.1 Applicable warrant period  
The period is within thirteen months since the date of shipping out under normal using and storage conditions.
- 5.4.2 Unaccepted responsibility  
This product has been manufactured to your company's specification as a part for use in your company's general electronic products. It is guaranteed to perform according to delivery specifications. For any other use apart from general electronic equipment , we cannot take responsibility if the product is used in nuclear power control equipment , aerospace equipment , fire and security

systems or any other applications in which there is a direct risk to human life and where extremely high levels of reliability are required.



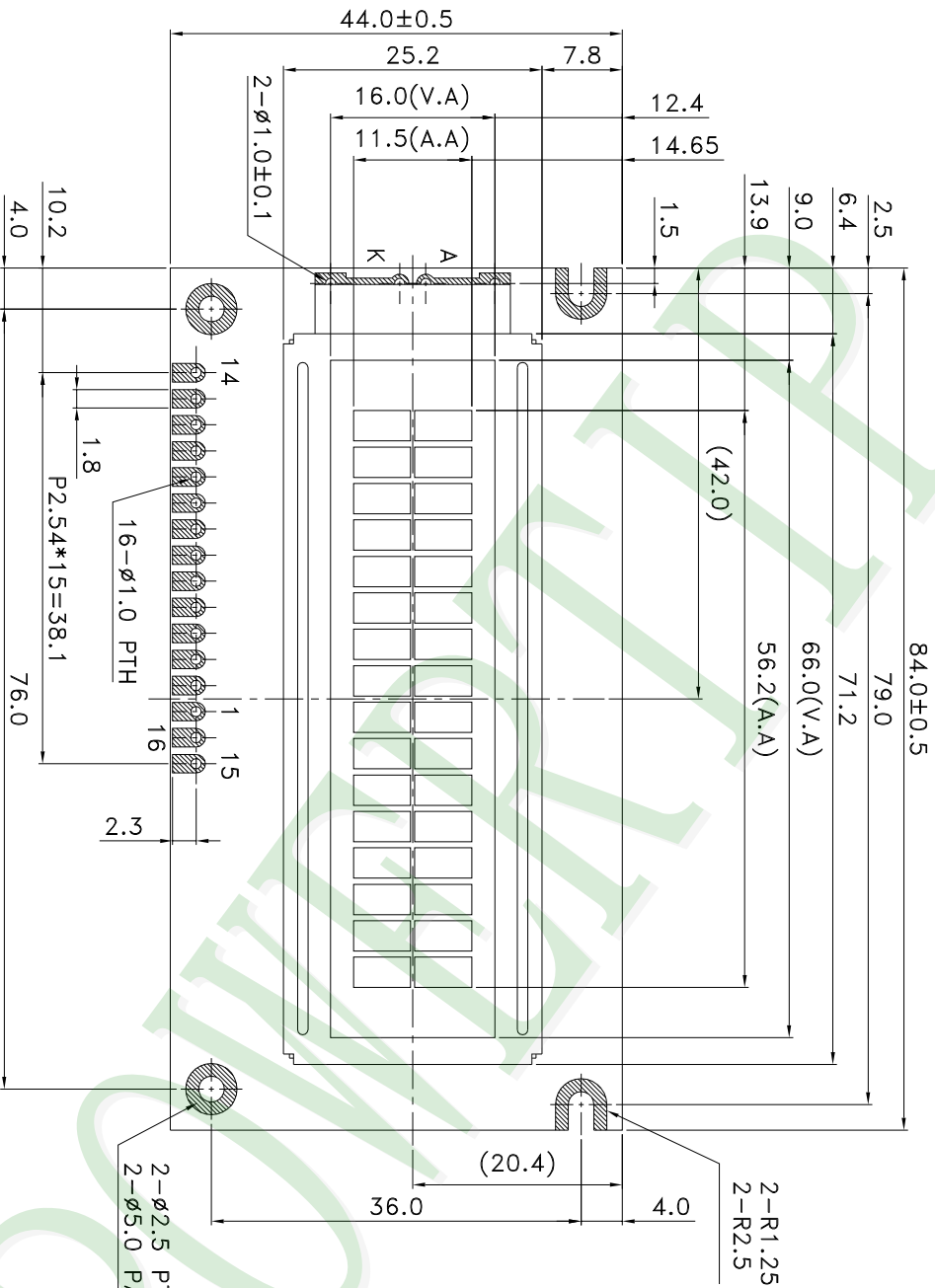

NOTES:

1. LCD TYPE: PBT
2. LCD DISPLAY: NEGATIVE/Transmissive
3. VIEW DIRECTION: 6 O'CLOCK
4. The tolerance unless classified  $\pm 0.3\text{mm}$

Scale: 5X

1  
2  
3 AUTODESK  
4 教育產品製造  
5  
6

由 AUTODESK 教育產品製造

007		PART NO:	NPCC1602WRP-FWT-1		<p>久正光電股份有限公司 POWER TIP TECHNOLOGY CORPORATION</p>	Design	Air	Surface Material Thickness Quantity	Precision Level 1 ~ 4 4 ~ 16 16 ~ 63 63 ~ 250 250 ~ 1000
006		DRAWING NAME:	JLMD-NPCC1602WRP-FWT-1			Check	Terry		
005		TITLE:	LCD MODULE DRAWING			Approve	Ryan		
004		REV BY	REV BY			DATE	2018/08/16		
003		REVISER	Air						
002									
001									



**1. 包裝材料規格表 (Packaging Material) : (per carton)**

No.	Item	Model	Dimensions (mm)	1Pcs Weight	Quantity	Total Weight
1	成品 (LCM)	NPC1602WRP-FWT-I	84.0 X 44.0 X 12.7	0.034	468	15.912
2	靜電袋(1)Antistatic Bag	BAG100100ARABA	100 X 100	0.0011	468	0.5148
3	A1-1隔板(2)A1-1 Partition	BX29500047BZBA	295 X 47 X 3	0.0078	168	1.3104
4	B1-1隔板(3)B1-1 Partition	BX24500047BZBA	245 X 47 X 3	0.0065	48	0.312
5	氣泡紙(4)Bubble Sheet	BAG280240BWABA	280 X 240	0.006	24	0.144
6	C1內盒(5)Product Box	BX31025555AABA	310 X 255 X 55	0.13	12	1.56
7	外紙箱(6)Carton	BX52732536CCBA	527 X 325 X 360	0.83	1	0.83
8						
9						

2. 一整箱總重量 (Total LCD Weight in carton) : 20.58 Kg±10%  
 3. 單箱數量規格表 (Packaging Specifications and Quantity) :  
 (1)Quantity Of Spacer : A1-1隔板 X 14 , B1-1隔板 X 4  
 (2)Total LCM quantity in carton : quantity per box 39 x no of boxes 12 = 468

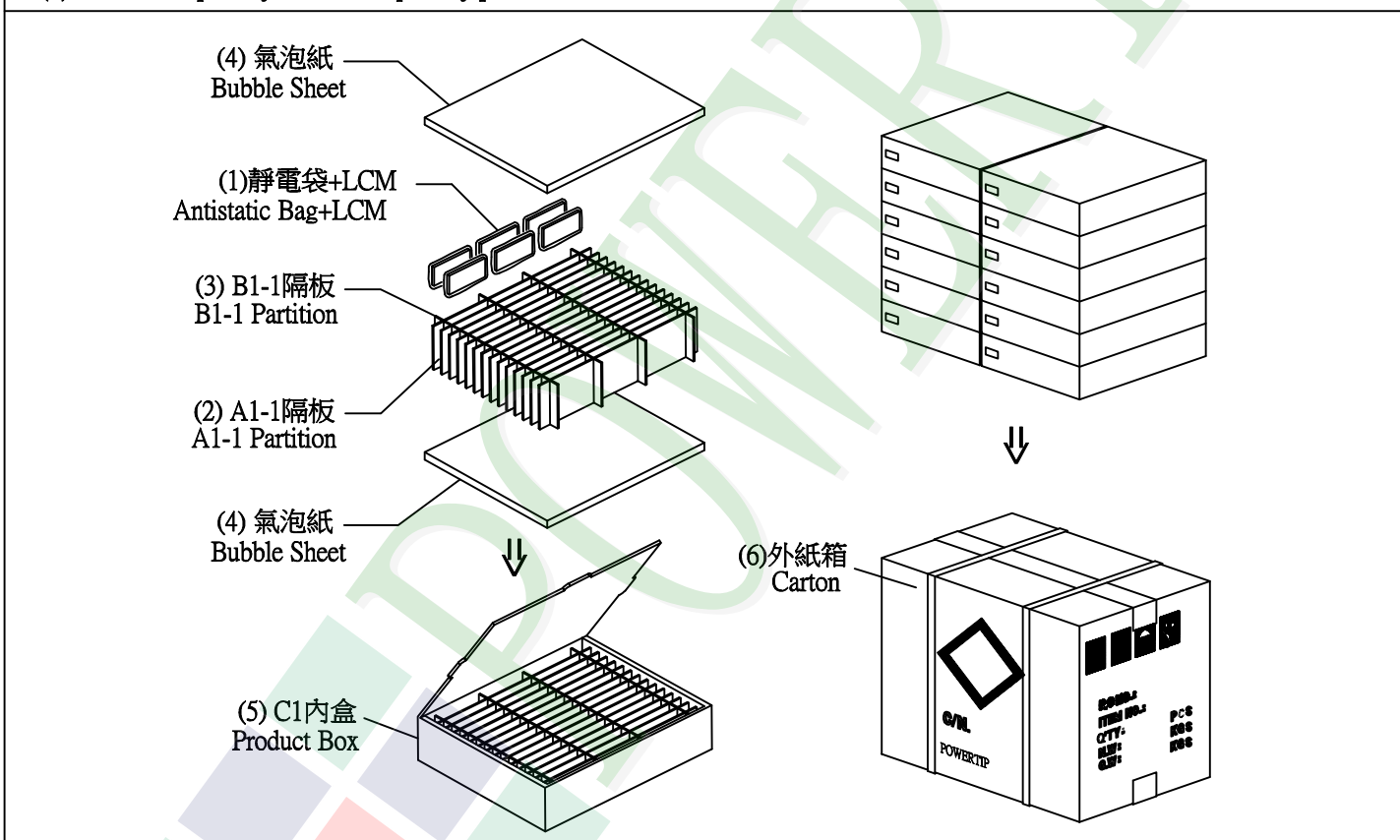

**特 記 事 項 (REMARK)**

<p>4. Label Specifications : 標籤依廠內標準作業</p>	<p>5. LCM排放示意圖(前後間隔不放置): 5. LCM placed as figure showing: ( First and last slot should be empty)</p> <div style="text-align: center;"> <p>▣ 模組(LCM) X 1pcs.</p> </div>	
--	--	--



## X-ON Electronics

Largest Supplier of Electrical and Electronic Components

*Click to view similar products for [TFT Displays & Accessories](#) category:*

*Click to view products by [Powertip](#) manufacturer:*

Other Similar products are found below :

[OAI-80038AA-2013-A](#) [HDA430T-3G1H](#) [EA CARREDIPTFT02](#) [NL6448BC20-21D](#) [TM022HDHT11-00](#) [NB7W-KBA04](#) [NB-ATT01](#)  
[NB5Q-ATT01](#) [NB5Q-KBA04](#) [NB-CN001](#) [NL12880BC20-05](#) [NL8060BC26-35C](#) [NL8060BC26-35F](#) [TCG104SVLQAPNN-AN20](#) [OAI-](#)  
[80038AA-2008-A](#) [315-U004B15300](#) [UMSH-8596MD-34T \(REV D\)](#) [98-0003-3490-8](#) [1044278](#) [1029309](#) [1060549](#) [DE 127-TU-30/7,5](#) [DE](#)  
[128-TU-20/7,5](#) [EP-LK007TFTPCAP](#) [FR7.0A00](#) [RC2002A-TIG-CSX](#) [NL6448BC2021C](#) [TX17D01VM2EAB](#) [TX14D23VM5BAA](#)  
[TCG121WXLRXVNNANX35](#) [EIC-LCD-1080P](#) [T272480C07VR01](#) [1060632](#) [TCG070WVLPAANN-AN50](#) [TCG035QVLPDANN-GN50](#)  
[1060630](#) [RFE430V-AIW-DNG](#) [T-55619GD065J-LW-ABN](#) [NHD-1.8-128160EF-SSXN-FT](#) [TCG104SVLPEANN-AN30](#) [NL6448BC33-70](#)  
[NL192108BC18-06F](#) [NLB150XG02L-01](#) [NL6448BC20-30D](#) [NL10276BC16-06](#) [NL192108AC10-01D](#) [NL6448AC18-08F](#) [NL6448BC20-30F](#)  
[NL12880BC20-05BD](#) [NL12880BC20-05D](#)