

SPECIFICATIONS

CUSTOMER	:	CIT018
SAMPLE CODE	:	SH128160T068-LAA11
MASS PRODUCTION CODE	:	PH128160T068-LAA11
SAMPLE VERSION	:	01
SPECIFICATIONS EDITION	:	003
DRAWING NO. (Ver.)	:	JLMD-PH128160T068-LAA11_001
PACKAGING NO. (Ver.)	:	JPKG-PH128160T068-LAA11_002

Customer Approved

Date:

Approved	Checked	Designer
劉進	劉進	陳璐

- Preliminary specification for design input
- Specification for sample approval

POWERTIP TECH. CORP.

Headquarters: No.8, 6 th Road, Taichung Industrial Park, Taichung, Taiwan 台中市 407 工業區六路 8 號	TEL: 886-4-2355-8168 FAX: 886-4-2355-8166	E-mail: sales@powertip.com.tw Http://www.powertip.com.tw
---	--	--

History of Version

Date	Ver.	Edi.	Description	Page	Design by
07/14/2021	01	001	New Drawing	-	陳璐
08/02/2021	01	002	New Sample	-	陳璐
10/08/2021	01	003	Modify LCM Packaging	Appendix	陳璐

Total: 26 Pages

Contents

1. SPECIFICATIONS

- 1.1 Features
- 1.2 Mechanical Specifications
- 1.3 Absolute Maximum Ratings
- 1.4 DC Electrical Characteristics
- 1.5 Optical Characteristics
- 1.6 Backlight Characteristics

2. MODULE STRUCTURE

- 2.1 Counter Drawing
- 2.2 Interface Pin Description
- 2.3 Timing Characteristics

3. QUALITY ASSURANCE SYSTEM

- 3.1 Quality Assurance Flow Chart
- 3.2 Inspection Specification

4. RELIABILITY TEST

- 4.1 Reliability Test Condition

5. PRECAUTION RELATING PRODUCT HANDLING

- 5.1 Safety
- 5.2 Handling
- 5.3 Storage
- 5.4 Terms of Warranty

- Appendix : 1. LCM Drawing
2. LCM Packaging

1. SPECIFICATIONS

1.1 Features

Main LCD Panel

Item	Standard Value
Display Type	128 * (R、G、B) * 160 Dots
LCD Type	a-Si TFT , Normally White TN mode , Transmissive
Screen size(inch)	1.77 (Diagonal)
Viewing Direction	12 O'clock
Color configuration	R.G.B. vertical stripe
Interface	8-bit interface for 80 system
Other(controller / driver IC)	ST7735S
ROHS	THIS PRODUCT CONFORMS THE ROHS OF PTC Detail information please refer web site : http://www.powertip.com.tw/news.php?area_id_view=1085560481/

1.2 Mechanical Specifications

Item	Standard Value	Unit
Outline Dimension	34.0 (W) * 47.0 (L) * 2.4 (H)(MAX)	mm

TFT LCD Panel

Item	Standard Value	Unit
Viewing Area (LCD)	29.032 (W) * 36.04 (L)	mm
Active Area (LCD)	28.032 (W) * 35.04 (L)	mm

Note: For detailed information please refer to LCM drawing.

1.3 Absolute Maximum Ratings

Module

Item	Symbol	Condition	Min.	Max.	Unit
System Power Supply Voltage	VDD	-	-0.3	+4.8	V
	VGH-VGL	-	-0.3	30.0	V
Input Voltage	VIN	-	-0.3	VDD+0.3	V
Operating Temperature	T _{OP} (Ts)	Note 1	-20	+70	°C
Storage Temperature	T _{ST} (Ta)	Note 2	-30	+80	°C
Storage Humidity	H _D	Ta ≤ 60 °C	10	90	%RH

The absolute maximum rating values of this product are not allowed to be exceeded at any times. Should a module be used with any of the absolute maximum ratings exceeded, the characteristics of the module may not be recovered, or in an extreme case, the module may be permanently destroyed.

Note 1 : Ts is the temperature of panel's surface.

Note 2 : Ta is the ambient temperature of samples.

1.4 DC Electrical Characteristics

Module

GND = 0V, Ta = 25°C

Item	Symbol	Condition	Min.	Typ.	Max.	Unit
Interface operation voltage	VDD	I/O supply voltage	2.5	3.0	3.3	V
Input High Voltage	V _{IH}	-	0.7*VDD	-	VDD	V
Input Low Voltage	V _{IL}	-	GND	-	0.3*VDD	V
Output High Voltage	V _{OH}	IOH=-0.1mA	0.8*VDD	-	VDD	V
Output Low Voltage	V _{OL}	IOL=0.1mA	GND	-	0.2*VDD	V
Supply Current	IDD	VDD=3.0V	-	2	3	mA

1.5 Optical Characteristics

TFT LCD Panel

VDD = 3.0V, Ta=25°C

Item	Symbol	Condition	Min.	Typ.	Max.	unit		
Response time	Tr + Tf	-	-	28	42	ms	Note2	
Viewing angle	Top	$\theta Y+$	CR \geq 10	-	15	-	Deg.	Note4
	Bottom	$\theta Y-$		-	45	-		
	Left	$\theta X-$		-	45	-		
	Right	$\theta X+$		-	45	-		
Contrast ratio	CR	-	200	250	-	-	Note3	
Color of CIE Coordinate (With B/L)	White	X	IF= 30mA	0.24	0.29	0.34	-	Note1
		Y		0.25	0.30	0.35		
	Red	X		0.54	0.59	0.64		
		Y		0.29	0.34	0.39		
	Green	X		0.29	0.34	0.39		
		Y		0.54	0.59	0.64		
	Blue	X		0.10	0.15	0.20		
		Y		0.02	0.07	0.12		
Average Brightness Pattern=white display (With B/L)	IV	IF= 30mA	190	260	-	cd/m ²	Note1	
Uniformity (With B/L)	ΔB		80	-	-	-	Note1	

Note1:

1 : $\Delta B = B(\min) / B(\max) \times 100\%$.

2 : Measurement Condition for Optical Characteristics:

a : Environment: $25^\circ\text{C} \pm 5^\circ\text{C}$ / $60 \pm 20\%$ R.H, no wind, dark room below 10 Lux at typical lamp current and typical operating frequency.

b : Measurement Distance: 500 ± 50 mm, ($\theta = 0^\circ$).

c : Equipment: TOPCON BM-7 fast, (field 1°), after 10 minutes operation.

d : The uncertainty of the C.I.E coordinate measurement ± 0.01 , Average Brightness $\pm 4\%$.

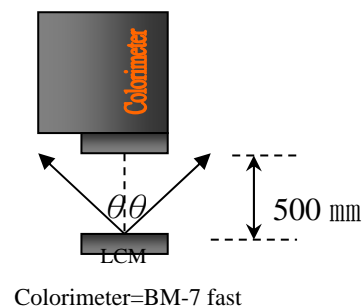
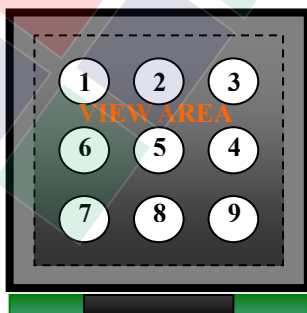

Note2: Definition of response time:

The output signals of photo detector are measured when the input signals are changed from “black” to “white”(falling time) and from “white” to “black”(rising time), respectively. The response time is defined as the time interval between the 10% and 90% of Amplitudes.

Refer to figure as below:

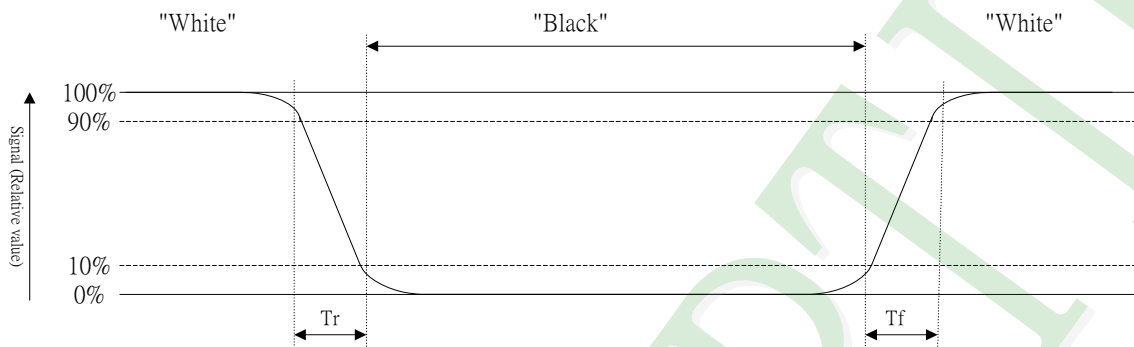

Note3: Definition of contrast ratio:

Contrast ratio is calculated with the following formula

$$\text{Contrast ratio (CR)} = \frac{\text{Photo detector output when LCD is at "White" state}}{\text{Photo detector output when LCD is at "Black" state}}$$

Note4: Definition of viewing angle:

Refer to figure as below:

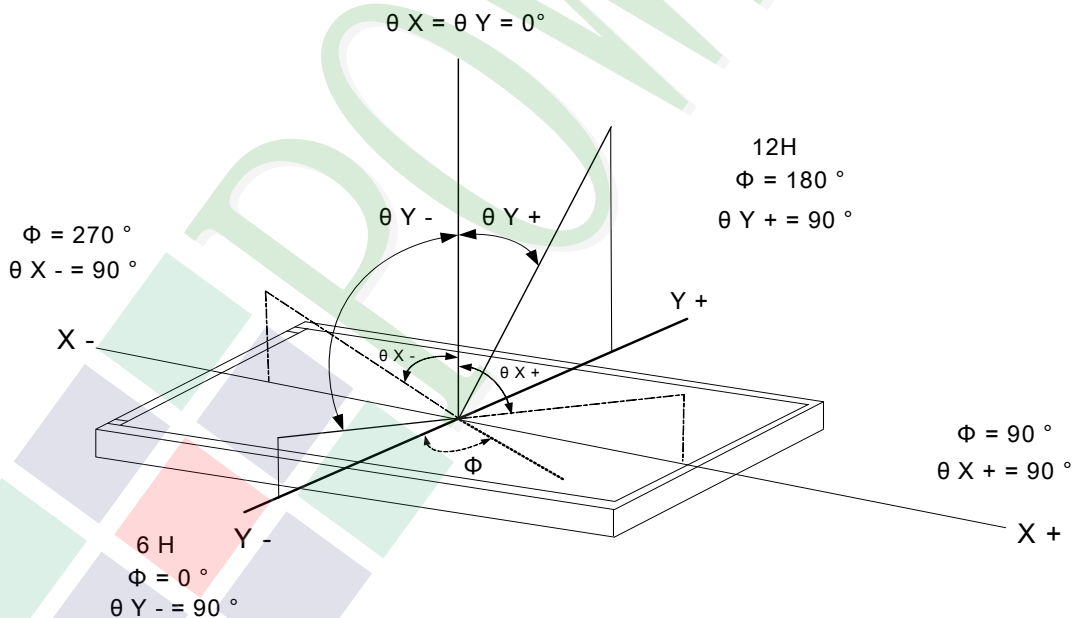

1.6 Backlight Characteristics

Maximum Ratings

Item	Symbol	Conditions	Min.	Max.	Unit
Forward Current	IF	Ta =25°C	-	30/LED	mA
Reverse Voltage	VR	Ta =25°C	-	5.0	V
Power Dissipation	PD	Ta =25°C	-	105	mW

Electrical / Optical Characteristics

Item	Symbol	Conditions	Min.	Typ.	Max.	Unit
Forward Voltage	VF	IF=30mA	2.8	3.3	3.5	V
Average Brightness (without LCD)	IV	IF=30mA	3200	3800	-	cd/m ²
Color of CIE Coordinate (without LCD)	X		0.25	0.28	0.31	-
	Y		0.25	0.28	0.31	
Color	White					

Internal Circuit Diagram

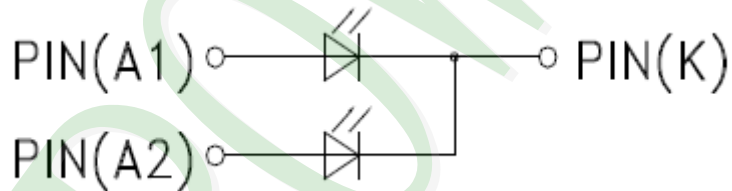

Other Description

Item	Conditions	Description
Life Time	Ta =25°C IF= 30mA	50000 hrs

2. MODULE STRUCTURE

2.1 Counter Drawing

2.1.1 LCM Mechanical Diagram

* See Appendix

2.1.2 Block Diagram

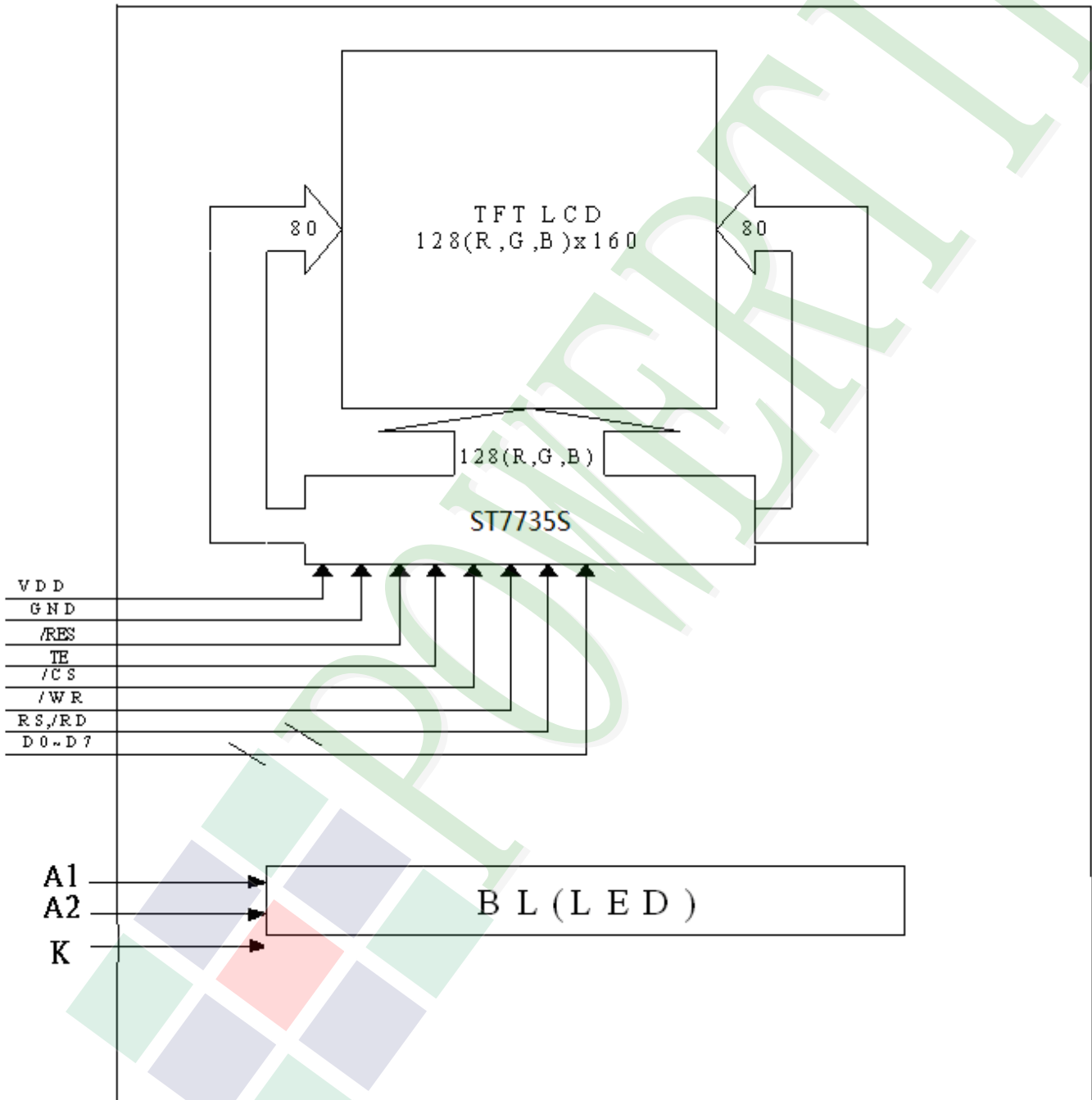

2.2 Interface Pin Description

Pin No.	Symbol	Function
1	K	Power Supply for LED Backlight Cathode input.
2	A2	Power Supply for LED Backlight Anode input.
3	A1	Power Supply for LED Backlight Anode input.
4	RD	Read signal input , Active "L".
5	RS	The signal for command or parameter select under parallel mode Low: command. ; High: parameter.
6	D1	Bi-directional data bus.
7	D3	Bi-directional data bus.
8	D5	Bi-directional data bus.
9	D7	Bi-directional data bus.
10	TE	Tearing effect output pin to synchronies MPU to frame rate,activated by S/W command
11	RESET	This signal will reset the device and it must be applied to properly initialize the chip, Active "L".
12	CS	Chip selection pin, Active "L".
13	D6	Bi-directional data bus.
14	D4	Bi-directional data bus.
15	D2	Bi-directional data bus.
16	D0	Bi-directional data bus.
17	WR	Write enable in MPU parallel interface, Active "L".
18	GND	System ground
19	VDD	Power supply for analog, digital , I/O system and booster circuit
20	AVDD	Power pin for analog circuits. Please Open This Pins
21	AVCL	A power supply pin for generating GVCL. Please Open This Pins
22	GND	System ground

2.2.1 Refer Initial code

```
void LCD_Init(void)
{
    lcddev.width=128;
    lcddev.height=160;
    LCD_WR_REG(0x0001);           //Software Reset

    delay_ms(120);               //Delay 120ms

    LCD_WR_REG(0x0011);         //Sleep out

    delay_ms(120);               //Delay 120ms

    LCD_WR_REG(0x0026);         //GAMMA Set
    LCD_WR_DATA(0x0008);

    LCD_WR_REG(0x00e0);         //Gamma adjustment (+ polarity)
    LCD_WR_DATA(0x003f);
    LCD_WR_DATA(0x001a);
    LCD_WR_DATA(0x000f);
    LCD_WR_DATA(0x0018);
    LCD_WR_DATA(0x002f);
    LCD_WR_DATA(0x0028);
    LCD_WR_DATA(0x0020);
    LCD_WR_DATA(0x0022);
    LCD_WR_DATA(0x001f);
    LCD_WR_DATA(0x001b);
    LCD_WR_DATA(0x0023);
    LCD_WR_DATA(0x0037);
    LCD_WR_DATA(0x0000);
    LCD_WR_DATA(0x0007);
    LCD_WR_DATA(0x0002);
    LCD_WR_DATA(0x0010);

    LCD_WR_REG(0x00e1);         //Gamma adjustment (- polarity)
    LCD_WR_DATA(0x000f);
    LCD_WR_DATA(0x001b);
    LCD_WR_DATA(0x000f);
    LCD_WR_DATA(0x0017);
    LCD_WR_DATA(0x0033);
    LCD_WR_DATA(0x002c);
    LCD_WR_DATA(0x0029);
    LCD_WR_DATA(0x002e);
    LCD_WR_DATA(0x0030);
    LCD_WR_DATA(0x0030);
    LCD_WR_DATA(0x0039);
    LCD_WR_DATA(0x003f);
    LCD_WR_DATA(0x0000);
    LCD_WR_DATA(0x0007);
    LCD_WR_DATA(0x0003);
}
```

```

LCD_WR_DATA(0x0010);

LCD_WR_REG(0x0020);           //Inverion OFF

LCD_WR_REG(0x0036);           //Memory data access control
LCD_WR_DATA(0x00c0);         //MY MX MV ML RGB MH - -

LCD_WR_REG(0x003a);           //Interface Pixel Format
LCD_WR_DATA(0x0005);         //16-bit/pixel

LCD_WR_REG(0x00B1);           //Frame Rate In normal mode
LCD_WR_DATA(0x0009);         //RTNA set 1-line period
LCD_WR_DATA(0x0029);         //FPA: front porch
LCD_WR_DATA(0x0029);         //BPA: back porch

LCD_WR_REG(0x00C0);           //Power control setting
LCD_WR_DATA(0x00a0|0x0002);   //AVDD=5V; VRHP: Set the GVDD voltage
LCD_WR_DATA(0x0002);         //VRHN: Set the GVCL voltage
LCD_WR_DATA(0x0004);

LCD_WR_REG(0x00c1);           //Power control setting
LCD_WR_DATA(0x00c5);         //BT: set VGH=AVDD*3=15V / VGL=-10V voltage

LCD_WR_REG(0x00c2);           //In normal mode (Full colors)
LCD_WR_DATA(0x000a);         //APA: adjust the operational amplifier
LCD_WR_DATA(0x0000);         //DCA: adjust the booster Voltage

LCD_WR_REG(0x00C5);           //VCOM
LCD_WR_DATA(0x0026);         //-1.375V

LCD_WR_REG(0x00C7);           //VCOM Pffset
LCD_WR_DATA(0x0010);         //0V

LCD_WR_REG(0x0029);
}

```

2.3 Timing Characteristics

80-System Bus Interface

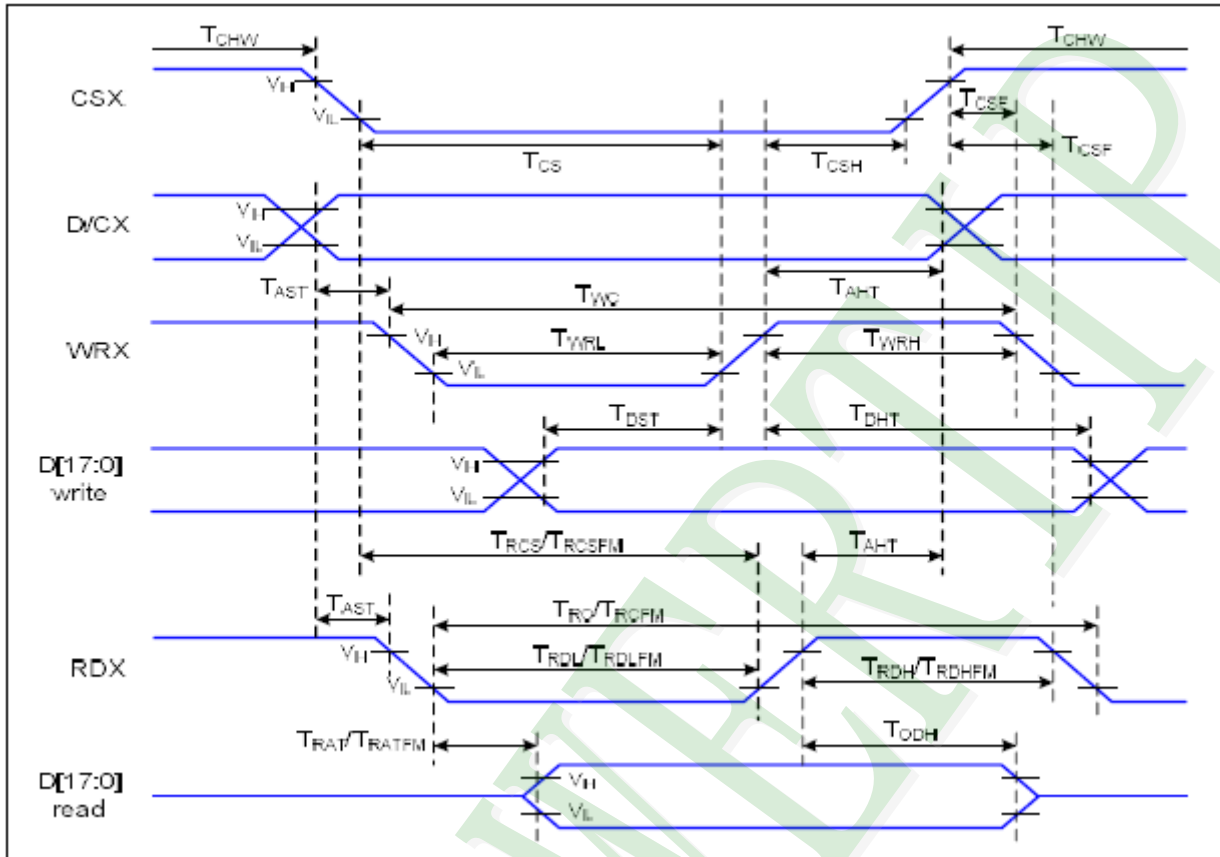

Ta=25 °C, VDDI=1.65~3.7V, VDD=2.5~4.8V

Signal	Symbol	Parameter	Min	Max	Unit	Description
D/CX	TAST	Address Setup Time	0		ns	
	TAHT	Address Hold Time (Write/Read)	10		ns	
CSX	TCHW	Chip Select "H" Pulse Width	0		ns	
	TCS	Chip Select Setup Time (Write)	15		ns	
	TRCS	Chip Select Setup Time (Read ID)	45		ns	
	TRCSFM	Chip Select Setup time (Read FM)	355		ns	
	TCSF	Chip Select Wait Time (Write/Read)	10		ns	
	TCSH	Chip Select Hold Time	10		ns	
WRX	TWC	Write Cycle	66		ns	
	TWRH	Control Pulse "H" Duration	15		ns	
	TWRL	Control Pulse "L" Duration	15		ns	
RDX (ID)	TRC	Read Cycle (ID)	160		ns	When Read ID Data
	TRDH	Control Pulse "H" Duration (ID)	90		ns	
	TRDL	Control Pulse "L" Duration (ID)	45		ns	
RDX (FM)	TRCFM	Read Cycle (FM)	450		ns	When Read from Frame Memory
	TRDHFM	Control Pulse "H" Duration (FM)	90		ns	
	TRDLFM	Control Pulse "L" Duration (FM)	355		ns	
D[17:0]	TDST	Data Setup Time	10		ns	For CL=30pF
	TDHT	Data Hold Time	10		ns	
	TRAT	Read Access Time (ID)		40	ns	
	TRATFM	Read Access Time (FM)		340	ns	
	TODH	Output Disable Time	20	80	ns	

Reset Timing

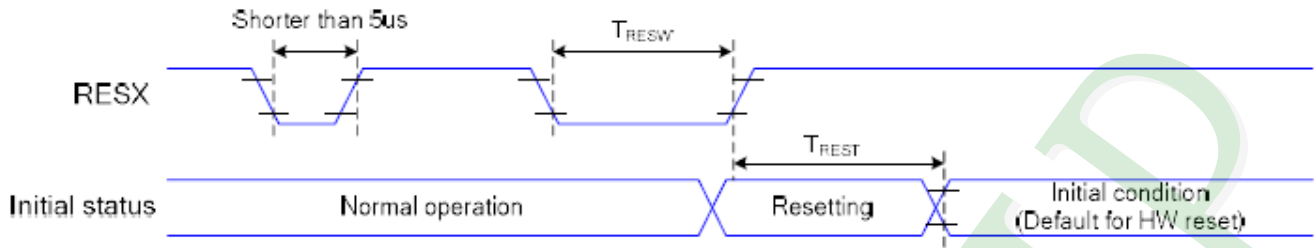

Related Pins	Symbol	Parameter	MIN	MAX	Unit
RESX	tRESW	Reset Pulse Duration	10	-	us
	tREST	Reset Cancel	-	5	ms
				120	ms

3. QUALITY ASSURANCE SYSTEM

3.1 Quality Assurance Flow Chart

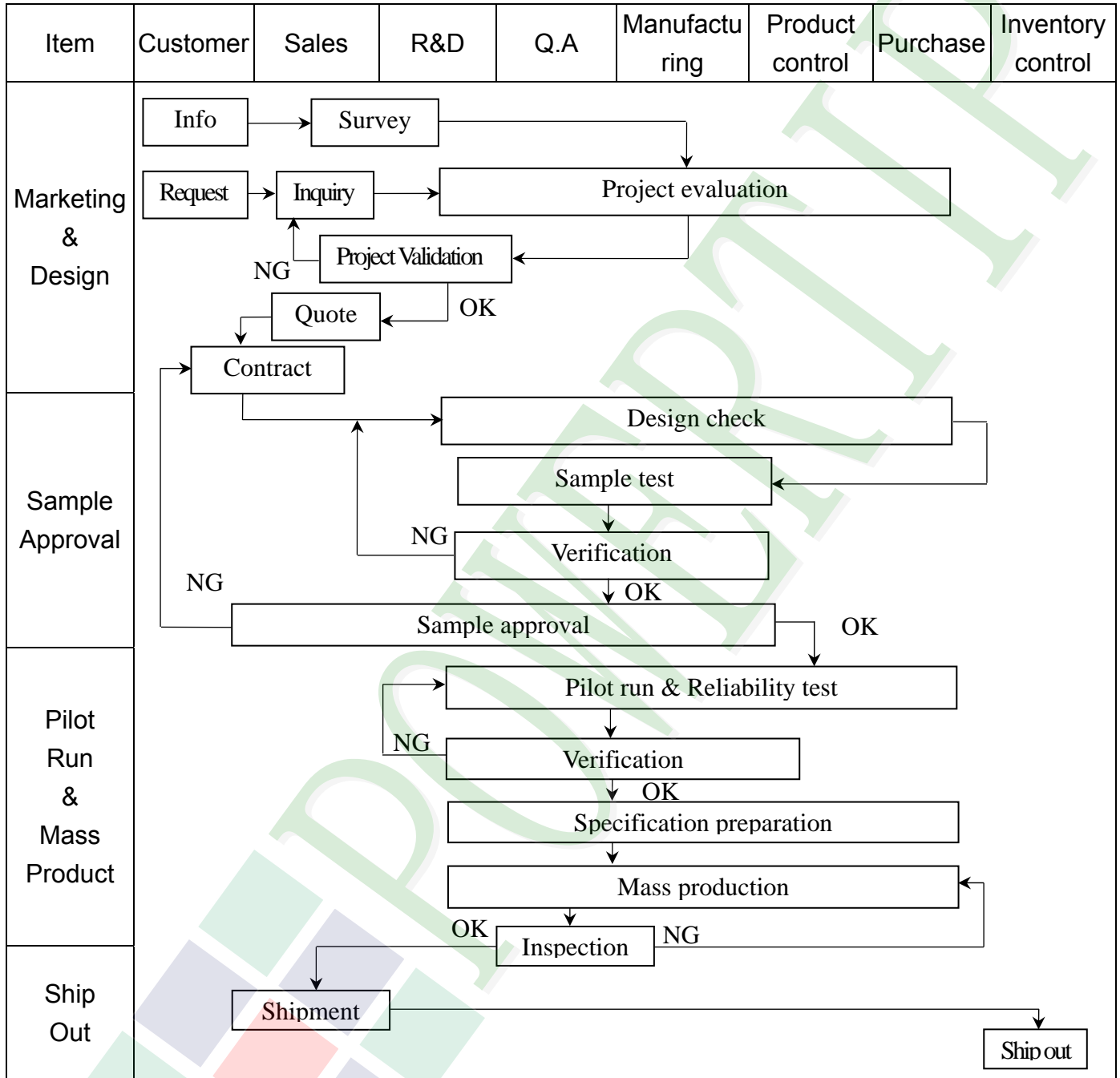

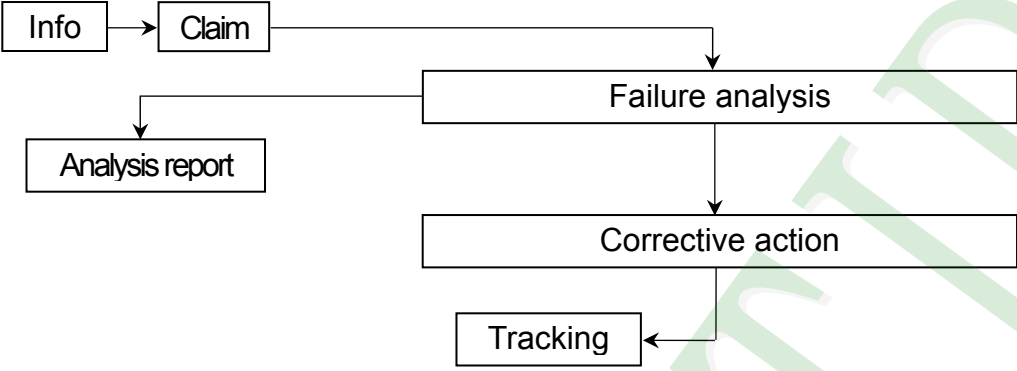
Item	Customer	Sales	R&D	Q.A	Manufacturing	Product control	Purchase	Inventory control
Sales Service	 <pre> graph TD Info[Info] --> Claim[Claim] Claim --> Failure[Failure analysis] Failure --> Report[Analysis report] Failure --> Action[Corrective action] Action --> Tracking[Tracking] </pre>							
Q.A Activity	1. ISO 9001 Maintenance Activities 3. Equipment calibration 5. Standardization Management				2. Process improvement proposal 4. Education And Training Activities			

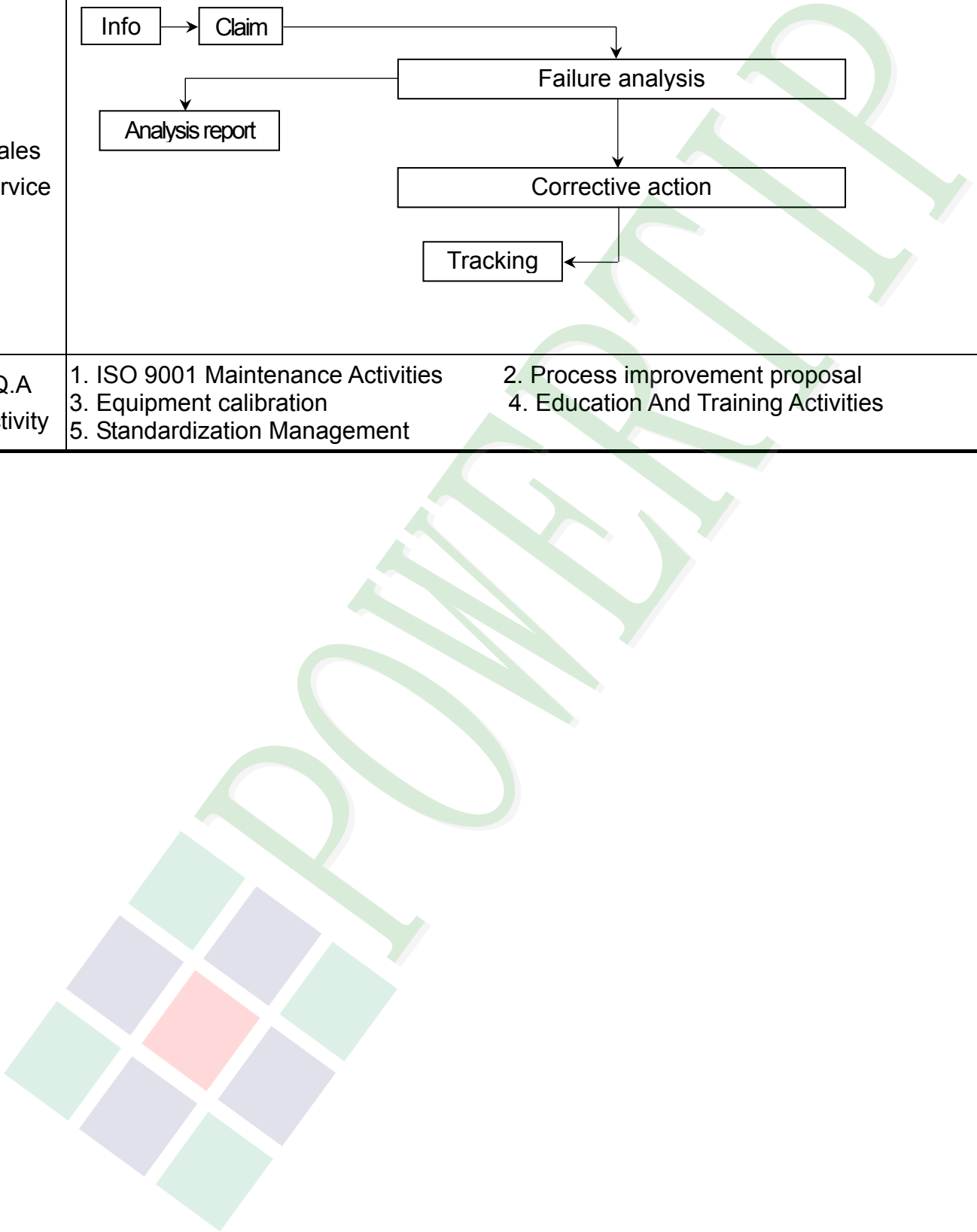

3.2. Inspection Specification

- ◆Scope : The document shall be applied to TFT-LCD Module for less than 3.5" (Ver.B01).
- ◆Inspection Standard : MIL-STD-105E Table Normal Inspection Single Sampling Level II.
- ◆Equipment : Gauge 、 MIL-STD 、 Powertip Tester 、 Sample
- ◆Defect Level : Major Defect AQL : 0.4 ; Minor Defect AQL : 1.5
- ◆OUT Going Defect Level: Sampling.
- ◆Standard of the product appearance test :

a. Manner of appearance test :

(1). The test best be under 20W×2 fluorescent light (about 300lux ~500lux)

， and distance of view must be at 30~40 cm.

(2). The test direction is base on about around 45° of vertical line.

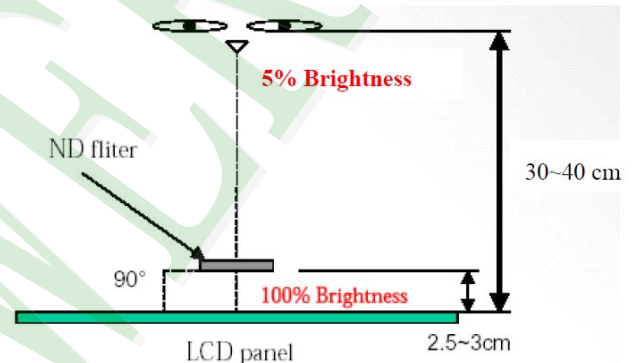
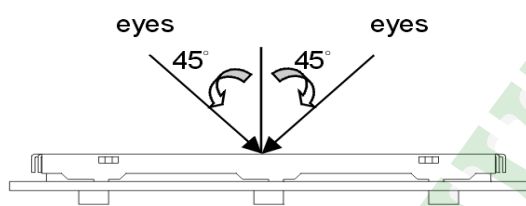

(3). Definition of area.

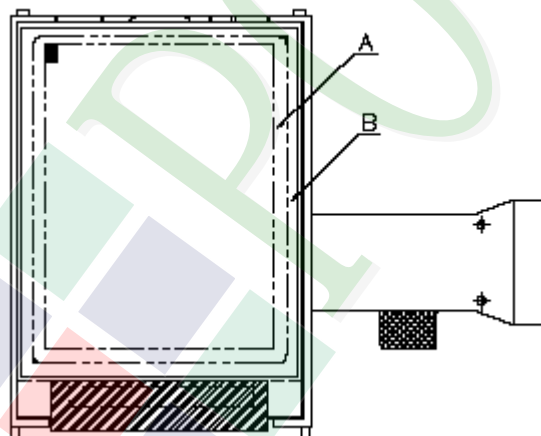

A area : viewing area

B area : Outside of viewing area

(4). Standard of inspection : (Unit : mm)

◆Specification For TFT-LCD Module Less Than 3.5" :

(Ver.B01)

NO	Item	Criterion	Level												
01	Product condition	1. 1 The part number is inconsistent with work order of production.	Major												
		1. 2 Mixed product types.	Major												
		1. 3 Assembled in inverse direction.	Major												
02	Quantity	2. 1 The quantity is inconsistent with work order of production.	Major												
03	Outline dimension	3. 1 Product dimension and structure must conform to structure diagram.	Major												
04	Electrical Testing	4. 1 Missing line character and icon.	Major												
		4. 2 No function or no display.	Major												
		4. 3 Display malfunction.	Major												
		4. 4 LCD viewing angle defect.	Major												
		4. 5 Current consumption exceeds product specifications.	Major												
		4. 6 Mura cannot be seen through 5% ND filter at 50% Gray , should be judged by the viewing angle of 90 degree.	Minor												
05	Dot defect (Bright dot 、 Dark dot) On -display	<table border="1"> <thead> <tr> <th></th> <th>Item</th> <th>Acceptance (Q'ty)</th> </tr> </thead> <tbody> <tr> <td rowspan="4">Dot Defect</td> <td>Bright Dot</td> <td>≤ 2</td> </tr> <tr> <td>Dark Dot</td> <td>≤ 3</td> </tr> <tr> <td>Joint Dot</td> <td>≤ 2</td> </tr> <tr> <td>Total</td> <td>≤ 3</td> </tr> </tbody> </table>		Item	Acceptance (Q'ty)	Dot Defect	Bright Dot	≤ 2	Dark Dot	≤ 3	Joint Dot	≤ 2	Total	≤ 3	Minor
			Item	Acceptance (Q'ty)											
Dot Defect	Bright Dot	≤ 2													
	Dark Dot	≤ 3													
	Joint Dot	≤ 2													
	Total	≤ 3													
5. 1 Inspection pattern : full white , full black , Red , Green and blue screens. 5. 2 It is defined as dot defect if defect area $> 1/2$ dot. 5. 3 The distance between two dot defect ≥ 5 mm. 5. 4 Bright dot that can not be seen through 5% ND filter.															

◆Specification For TFT-LCD Module Less Than 3.5" :

(Ver.B01)

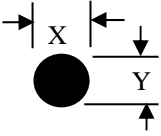
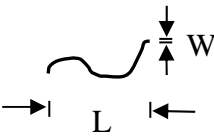
NO	Item	Criterion	Level																																								
06	<p>Black or white dot、scratch、contamination</p> <p>Round type</p>  <p>$\Phi = (x + y) / 2$</p> <p>Line type</p> 	<p>6. 1 Round type (Non-display or display) :</p> <table border="1" data-bbox="547 439 1323 893"> <thead> <tr> <th rowspan="2">Dimension (diameter : Φ)</th> <th colspan="2">Acceptance (Q'ty)</th> </tr> <tr> <th>A area</th> <th>B area</th> </tr> </thead> <tbody> <tr> <td>$\Phi \leq 0.15$</td> <td colspan="2">Ignore</td> </tr> <tr> <td>$0.15 < \Phi \leq 0.20$</td> <td>2</td> <td rowspan="3">Ignore</td> </tr> <tr> <td>$0.20 < \Phi \leq 0.30$</td> <td>2</td> </tr> <tr> <td>$\Phi > 0.30$</td> <td>0</td> </tr> <tr> <td>Total</td> <td colspan="2">3</td> </tr> </tbody> </table> <p>6. 2 Line type(Non-display or display) :</p> <table border="1" data-bbox="526 1012 1342 1426"> <thead> <tr> <th colspan="2">Dimension</th> <th colspan="2">Acceptance (Q'ty)</th> </tr> <tr> <th>Length (L)</th> <th>Width (W)</th> <th>A area</th> <th>B area</th> </tr> </thead> <tbody> <tr> <td>---</td> <td>$W \leq 0.03$</td> <td>Ignore</td> <td rowspan="4">Ignore</td> </tr> <tr> <td>$L \leq 5.0$</td> <td>$0.03 < W \leq 0.05$</td> <td>3</td> </tr> <tr> <td>---</td> <td>$W > 0.05$</td> <td>As round type</td> </tr> <tr> <td colspan="2">Total</td> <td colspan="2">3</td> </tr> </tbody> </table>	Dimension (diameter : Φ)	Acceptance (Q'ty)		A area	B area	$\Phi \leq 0.15$	Ignore		$0.15 < \Phi \leq 0.20$	2	Ignore	$0.20 < \Phi \leq 0.30$	2	$\Phi > 0.30$	0	Total	3		Dimension		Acceptance (Q'ty)		Length (L)	Width (W)	A area	B area	---	$W \leq 0.03$	Ignore	Ignore	$L \leq 5.0$	$0.03 < W \leq 0.05$	3	---	$W > 0.05$	As round type	Total		3		Minor
Dimension (diameter : Φ)	Acceptance (Q'ty)																																										
	A area	B area																																									
$\Phi \leq 0.15$	Ignore																																										
$0.15 < \Phi \leq 0.20$	2	Ignore																																									
$0.20 < \Phi \leq 0.30$	2																																										
$\Phi > 0.30$	0																																										
Total	3																																										
Dimension		Acceptance (Q'ty)																																									
Length (L)	Width (W)	A area	B area																																								
---	$W \leq 0.03$	Ignore	Ignore																																								
$L \leq 5.0$	$0.03 < W \leq 0.05$	3																																									
---	$W > 0.05$	As round type																																									
Total		3																																									
07	Polarizer Bubble	<table border="1" data-bbox="536 1478 1334 1890"> <thead> <tr> <th rowspan="2">Dimension (diameter : Φ)</th> <th colspan="2">Acceptance (Q'ty)</th> </tr> <tr> <th>A area</th> <th>B area</th> </tr> </thead> <tbody> <tr> <td>$\Phi \leq 0.20$</td> <td colspan="2">Ignore</td> </tr> <tr> <td>$0.20 < \Phi \leq 0.50$</td> <td>3</td> <td rowspan="3">Ignore</td> </tr> <tr> <td>$\Phi > 0.50$</td> <td>0</td> </tr> <tr> <td>Total</td> <td colspan="2">3</td> </tr> </tbody> </table>	Dimension (diameter : Φ)	Acceptance (Q'ty)		A area	B area	$\Phi \leq 0.20$	Ignore		$0.20 < \Phi \leq 0.50$	3	Ignore	$\Phi > 0.50$	0	Total	3		Minor																								
Dimension (diameter : Φ)	Acceptance (Q'ty)																																										
	A area	B area																																									
$\Phi \leq 0.20$	Ignore																																										
$0.20 < \Phi \leq 0.50$	3	Ignore																																									
$\Phi > 0.50$	0																																										
Total	3																																										

◆Specification For TFT-LCD Module Less Than 3.5" :

(Ver.B01)

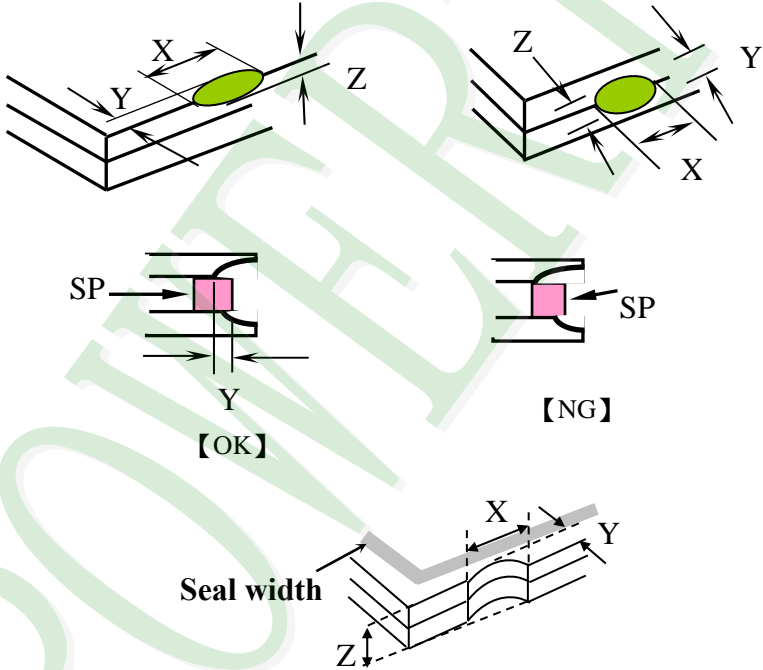
NO	Item	Criterion	Level									
08	The crack of glass	<p>Symbols :</p> <p>X : The length of crack Z : The thickness of crack t : The thickness of glass</p> <p>Y : The width of crack. W : terminal length a : LCD side length</p> <hr/> <p>8.1 General glass chip :</p> <p>8.1.1 Chip on panel surface and crack between panels:</p>  <table border="1" data-bbox="539 1476 1353 1771"> <thead> <tr> <th>X</th> <th>Y</th> <th>Z</th> </tr> </thead> <tbody> <tr> <td>$\leq a$</td> <td>Crack can't enter viewing area</td> <td>$\leq 1/2 t$</td> </tr> <tr> <td>$\leq a$</td> <td>Crack can't exceed the half of SP width.</td> <td>$1/2 t < Z \leq 2 t$</td> </tr> </tbody> </table>	X	Y	Z	$\leq a$	Crack can't enter viewing area	$\leq 1/2 t$	$\leq a$	Crack can't exceed the half of SP width.	$1/2 t < Z \leq 2 t$	Minor
		X	Y	Z								
$\leq a$	Crack can't enter viewing area	$\leq 1/2 t$										
$\leq a$	Crack can't exceed the half of SP width.	$1/2 t < Z \leq 2 t$										

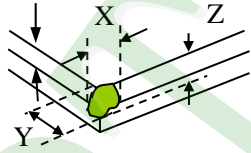
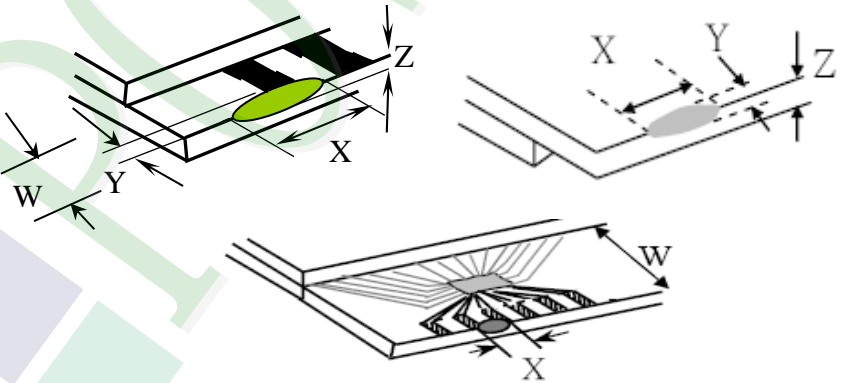
NO	Item	Criterion	Level									
08	The crack of glass	<p>Symbols :</p> <p>X : The length of crack Z : The thickness of crack t : The thickness of glass</p> <p>Y : The width of crack. W : terminal length a : LCD side length</p> <hr/> <p>8.1.2 Corner crack :</p>  <table border="1" data-bbox="525 799 1342 1093"> <thead> <tr> <th>X</th> <th>Y</th> <th>Z</th> </tr> </thead> <tbody> <tr> <td>$\leq 1/5 a$</td> <td>Crack can't enter viewing area</td> <td>$Z \leq 1/2 t$</td> </tr> <tr> <td>$\leq 1/5 a$</td> <td>Crack can't exceed the half of SP width.</td> <td>$1/2 t < Z \leq 2 t$</td> </tr> </tbody> </table>	X	Y	Z	$\leq 1/5 a$	Crack can't enter viewing area	$Z \leq 1/2 t$	$\leq 1/5 a$	Crack can't exceed the half of SP width.	$1/2 t < Z \leq 2 t$	Minor
		X	Y	Z								
$\leq 1/5 a$	Crack can't enter viewing area	$Z \leq 1/2 t$										
$\leq 1/5 a$	Crack can't exceed the half of SP width.	$1/2 t < Z \leq 2 t$										
<p>8.2 Protrusion over terminal :</p> <p>8.2.1 Chip on electrode pad :</p>  <table border="1" data-bbox="563 1697 1351 1870"> <thead> <tr> <th></th> <th>X</th> <th>Y</th> <th>Z</th> </tr> </thead> <tbody> <tr> <td>Front</td> <td>$\leq a$</td> <td>$\leq 1/2 W$</td> <td>$\leq t$</td> </tr> <tr> <td>Back</td> <td>$\leq a$</td> <td>$\leq W$</td> <td>$\leq 1/2 t$</td> </tr> </tbody> </table>		X	Y	Z	Front	$\leq a$	$\leq 1/2 W$	$\leq t$	Back	$\leq a$	$\leq W$	$\leq 1/2 t$
	X	Y	Z									
Front	$\leq a$	$\leq 1/2 W$	$\leq t$									
Back	$\leq a$	$\leq W$	$\leq 1/2 t$									

◆Specification For TFT-LCD Module Less Than 3.5" :

(Ver.B01)

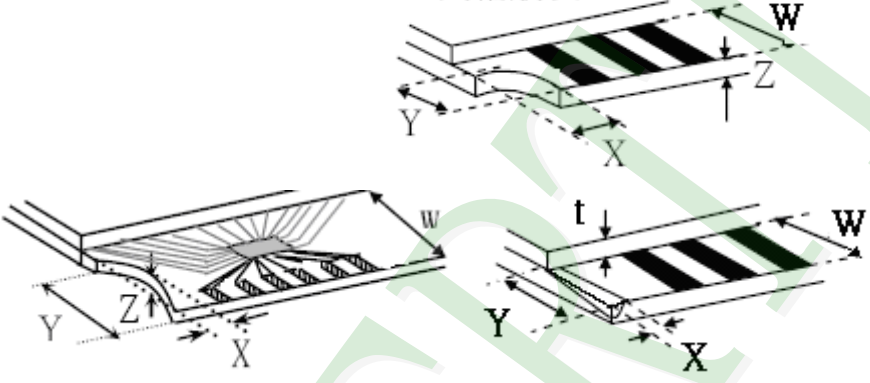
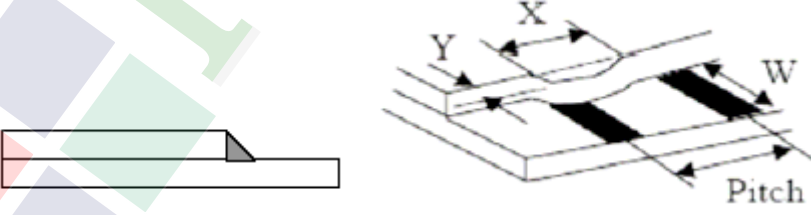
NO	Item	Criterion	Level												
08	The crack of glass	<p>Symbols :</p> <p>X : The length of crack Y : The width of crack. Z : The thickness of crack W : terminal length t : The thickness of glass a : LCD side length</p> <hr/> <p>8.2.2 Non-conductive portion :</p>  <table border="1" data-bbox="619 981 1252 1137"> <thead> <tr> <th>X</th> <th>Y</th> <th>Z</th> </tr> </thead> <tbody> <tr> <td>$\leq 1/3 a$</td> <td>$\leq W$</td> <td>$\leq t$</td> </tr> </tbody> </table> <p>○ If the chipped area touches the ITO terminal, over 2/3 of 1. the ITO must remain and be inspected according to electrode terminal specifications.</p> <p>8.2.3 Glass remain :</p>  <table border="1" data-bbox="542 1787 1236 1908"> <thead> <tr> <th>X</th> <th>Y</th> <th>Z</th> </tr> </thead> <tbody> <tr> <td>$\leq a$</td> <td>$\leq 1/3 W$</td> <td>$\leq t$</td> </tr> </tbody> </table>	X	Y	Z	$\leq 1/3 a$	$\leq W$	$\leq t$	X	Y	Z	$\leq a$	$\leq 1/3 W$	$\leq t$	Minor
X	Y	Z													
$\leq 1/3 a$	$\leq W$	$\leq t$													
X	Y	Z													
$\leq a$	$\leq 1/3 W$	$\leq t$													

◆Specification For TFT-LCD Module Less Than 3.5" :

(Ver.B01)

NO	Item	Criterion	Level
09	Backlight elements	9. 1 Backlight can't work normally.	Major
		9. 2 Backlight doesn't light or color is wrong.	Major
		9. 3 Illumination source flickers when lit.	Major
10	General appearance	10. 1 Pin type 、 quantity 、 dimension must match type in structure diagram.	Major
		10. 2 No short circuits in components on PCB or FPC.	Major
		10. 3 Parts on PCB or FPC must be: no wrong parts, missing parts or excess parts.	Major
		10. 4 Product packaging must the same as specified on packaging specification sheet.	Minor
		10. 5 The folding and peeled off in polarizer are not acceptable.	Minor
		10. 6 The PCB or FPC between B/L assembled distance(PCB or FPC) is ≤ 1.5 mm.	Minor

5. PRECAUTION RELATING PRODUCT HANDLING

5.1 SAFETY

- 5.1.1 If the LCD panel breaks, be careful not to get the liquid crystal to touch your skin.
- 5.1.2 If the liquid crystal touches your skin or clothes, please wash it off immediately by using soap and water.

5.2 HANDLING

- 5.2.1 Avoid any strong mechanical shock which can break the glass.
- 5.2.2 Avoid static electricity which can damage the CMOS LSI—When working with the module, be sure to ground your body and any electrical equipment you may be using.
- 5.2.3 Do not remove the panel or frame from the module.
- 5.2.4 The polarizing plate of the display is very fragile. So, please handle it very carefully, do not touch, push or rub the exposed polarizing with anything harder than an HB pencil lead (glass, tweezers, etc.)
- 5.2.5 Do not wipe the polarizing plate with a dry cloth, as it may easily scratch the surface of plate.
- 5.2.6 Do not touch the display area with bare hands, this will stain the display area.
- 5.2.7 Do not use ketonics solvent & aromatic solvent. Use with a soft cloth soaked with a cleaning naphtha solvent.
- 5.2.8 To control temperature and time of soldering is $320 \pm 10^{\circ}\text{C}$ and 3-5 sec.
- 5.2.9 To avoid liquid (include organic solvent) stained on LCM
- 5.2.10 Caution!(LCM products with Capacitive Touch Panel)
Strong EMI-sources such as switch-mode power supplies (SMPS) can lead to touch malfunction (e.g. ghost-touches).
Therefore, the touch needs to be thoroughly tested inside the target application.
- 5.2.11 CAUTION: Continuously displaying same static image will result in high possibility of image sticking/image burn-in effect due to TFT panel characteristic.
- 5.2.12 Double-sided tape designed to be attach with the customer's mechanical device, please follow up the rules and regulations published by the original manufacturer of double-sided tape for the attachment operation.

5.3 STORAGE

- 5.3.1 Store the panel or module in a dark place where the temperature is $25^{\circ}\text{C} \pm 5^{\circ}\text{C}$ and the humidity is below 65% RH.
- 5.3.2 Do not place the module near organics solvents or corrosive gases.
- 5.3.3 Do not crush, shake, or jolt the module.

5.4 TERMS OF WARRANTY

- 5.4.1 Applicable warrant period The period is within thirteen months since the date of shipping out under normal using and storage conditions.
- 5.4.2 Unaccepted responsibility
This product has been manufactured to your company's specification as a part for use in your company's general electronic products. It is guaranteed to perform according to delivery specifications. For any other use apart from general electronic equipment, we cannot take responsibility if the product is used in nuclear power control equipment, aerospace equipment, fire and security systems or any other applications in which there is a direct risk to human life and where extremely high levels of reliability are required.

A

B

C

D

E

F

G

H

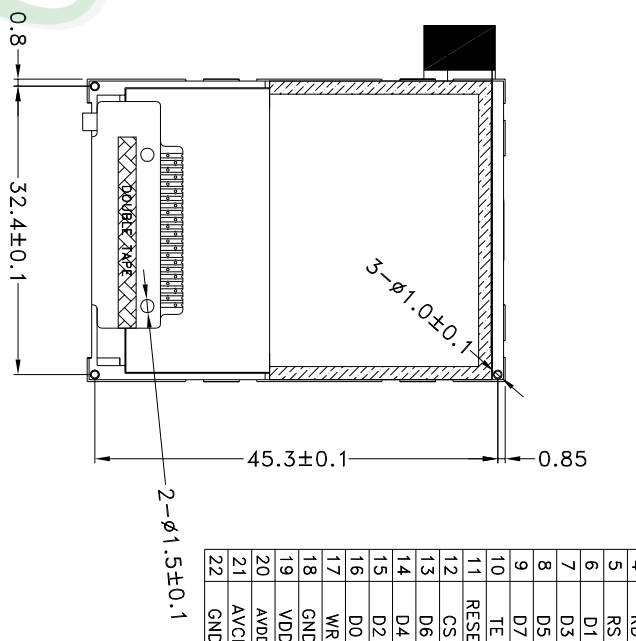
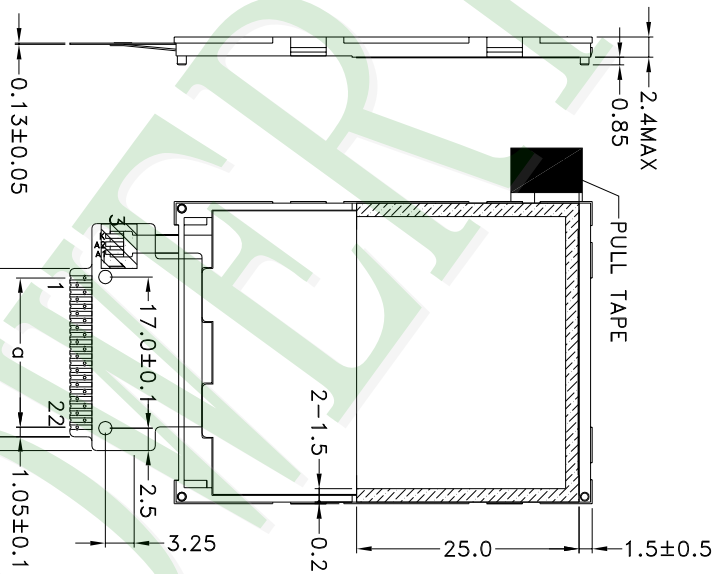
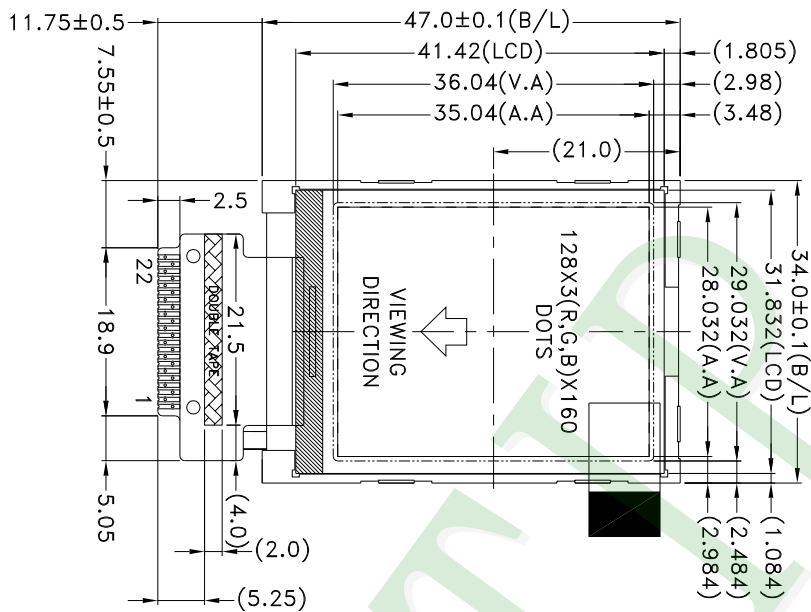

No	PIN NAME
1	K
2	A2
3	A1
4	RD
5	RS
6	D1
7	D3
8	D5
9	D7
10	TE
11	RESET
12	CS
13	D6
14	D4
15	D2
16	D0
17	WR
18	GND
19	VDD
20	AVDD
21	AVCL
22	GND

NOTES:

- 1.THE TOLERANCE UNLESS CLASSIFIED±0.2mm
- 2.R=0.5±0.1mm FOR NOT ASSIGNED
- 3.OPERATING TEMP:-20°C~70°C
- 4.STORAGE TEMP:-30°C~80°C
- 5.LCD DRIVER:ST7735S
- 6.VIEWING DIRECTION:12 O'CLOCK
- 7.BACKLIGHT:LUMINANCE >=100cd/m², UNIFORMITY >=80%
8. DOUBLE TAPE(T=0.05mm)
- 9.c:P0.8x21=16.8±0.05(W=0.5±0.05)

PART NO:
PH128160T068-LAA11

江蘇久正光電有限公司
JIANGSU POWER TIP TECHNOLOGY CORP.LTD.

DRAWING NAME:
JLMD-PH128160T068-LAA11

Design
Crystal

Surface
Material

公差 精度
最小 長度 級

TITLE:
LCD MODULE DRAWING

Check
Air

Unit
MM

精 級

REV BY
NEW DRAWING

Approve
Lujin

Scale
4:5

Page
1/1

REV
Crystal

DATE
2021/07/13

Quantity

250 ~ 1000

Ver.002

LCM包裝規格書

Approve	Check	Contact
LiuJin	Air	Crystal

Documents NO. JPKG-PH128160T068-LAA11

LCM Packaging Specifications (For Tray)

1. 包裝材料規格表 (Packaging Material) : (per carton)

No.	Item	Model	Dimensions (mm)	1Pcs Weight	Quantity	Total Weight
1	成品 (LCM)	PH128160T068-LAA11	34.0 X 47.0 X 2.4	0.0055	672	3.696
2	多層薄膜(1)POF	OTFILM0BA03ABA	19"X350X0.015	—	6	—
3	TRAY 盤 (2)Tray	TYSG000000073 Δ	352 X 260 X 10.8	0.1	48	4.8
4	內盒(3)Product Box	BX36627063ABBA	393 X 274 X 68	0.2692	6	1.6152
5	保利龍板(4)Polylon board	OTPLB00PL08ABA	550 X 393 X 20	0.0284	2	0.0568
6	外紙箱(5)Carton	BX57041027CCBA	570 X 410 X 265	1.4208	1	1.4208
7	舒美墊(7)	OTFOAMPHD05ABA	310 X 225 X 1	0.0005	42	0.021
8						
9						

2. 一整箱總重量 (Total LCD Weight in carton) : 11.61 Kg \pm 10% 取小數2位

3. 單箱數量規格表 (Packaging Specifications and Quantity) :

(1) LCM quantity per box : no per tray	16	x no of tray	7	=	112
(2) Total LCM quantity in carton : quantity per box	112	x no of boxes	6	=	672

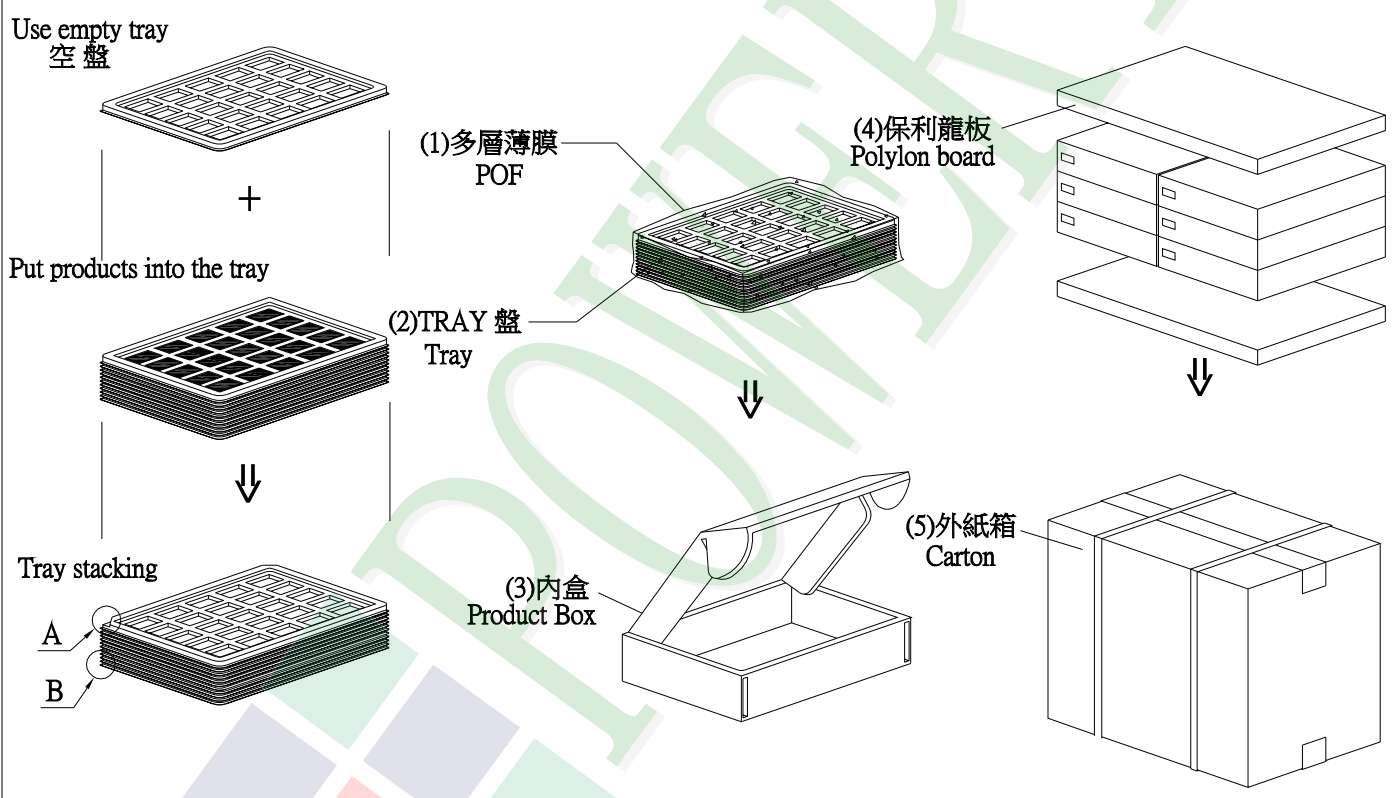

特 記 事 項 (REMARK)

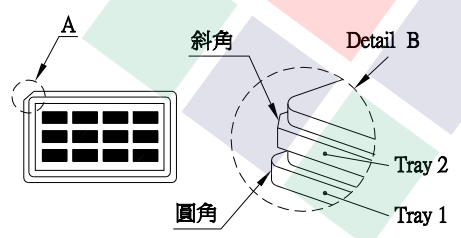

2. TRAY盤相疊時, 需旋轉180度, 請詳見B視圖
 Rotate tray 180 degrees and place on top of stack.
 Check the tray stack using Fig. B.

X-ON Electronics

Largest Supplier of Electrical and Electronic Components

Click to view similar products for [TFT Displays & Accessories category](#):

Click to view products by [Powertip manufacturer](#):

Other Similar products are found below :

[OAI-80038AA-2013-A](#) [HDA430T-3G1H](#) [NB-ATT01](#) [TCG104SVLQAPNN-AN20](#) [OAI-80038AA-2008-A](#) [315-U004B15300](#) [EIC-LCD-1080P](#) [NL10276BC20-18C](#) [DEM 128160D](#) [TMH-PW-N](#) [RFE43BU-AIW-DNG](#) [EA WF050-40S](#) [EA WF050-40ST](#) [RFC350X-AWW-DNG](#) [RFS390E-AWW-DNN](#) [DEM 480272G2](#) [VMX-PW-N \(A-TOUCH\)](#) [PH800480T013-ICA](#) [DEM 1024600N](#) [VMX-PW-N \(C-TOUCH\)](#) [DEM 1024600P](#) [VMH-PW-N \(C-TOUCH\)](#) [SM-RVT50HQHNWCA0](#) [DEM 240280A](#) [VMH-PW-N](#) [DEM 170320A](#) [VMH-PW-N](#) [PH240320T068-LAB08](#) [DEM 800480T1](#) [TMH-PW-N](#) [PH128128T041-LAA07](#) [PH480272T005-IAC02](#) [DEM 1024600P](#) [VMH-PW-N \(A-TOUCH\)](#) [DEM 800480T1](#) [TMH-PW-N \(C-TOUCH\)](#) [DEM 800480Q4](#) [VMX-PW-N](#) [DEM 800480T1](#) [TMH-PW-N \(A-TOUCH\)](#) [PH320240T-023-I02Q](#) [PH128800T004-ZZA01](#) [RFE430W-1YW-DBS](#) [DEM 1024600N](#) [VMX-PW-N \(A-TOUCH\)](#) [PH240320T074-ZAA01](#) [DEM 480480D](#) [VMX-PW-N \(C-TOUCH\)](#) [SM-RVT50HQSNWN00](#) [SM-RVT50HQHNWC00](#) [PH800480T033-ICB01](#) [RFE430W-AWW-DNN](#) [DEM 096096A](#) [VMH-PW-N](#) [RL0F00050000FGAAASA01](#) [SM-RVT50HQSNWCA0](#) [SM-RVT50HQSNWC00-B](#) [PH320240T028-ZEA01](#) [RFE430W-1YW-DBN](#) [SM-RVT50HQHNWC00-B](#) [DEM 120240A](#) [VMH-PW-N](#) [DEM 268800A](#) [VMH-PW-N](#) [RFF700B4-AIW-DNS](#) [DEM 800480O1](#) [VMH-PW-N](#)