



## SPECIFICATIONS

CUSTOMER	:	PTC
SAMPLE CODE	:	SH128800T004-ZZA01
MASS PRODUCTION CODE	:	PH128800T004-ZZA01
SAMPLE VERSION	:	04
SPECIFICATIONS EDITION	:	013
DRAWING NO. (Ver.)	:	JLMD-PH128800T004-ZZA01_006
PACKAGING NO. (Ver.)	:	JPKG-PH128800T004-ZZA01_001

**Customer Approved**

**Date:**

Approved	Checked	Designer
劉進 Jin Liu	劉進 Jin Liu	陳璐 Lu Chen

- Preliminary specification for design input
- Specification for sample approval

### POWERTIP TECH. CORP.

<b>Headquarters:</b> No.8, 6 <sup>th</sup> Road, Taichung Industrial Park, Taichung, Taiwan 台中市 407 工業區六路 8 號	TEL: 886-4-2355-8168 FAX: 886-4-2355-8166	E-mail: <a href="mailto:sales@powertip.com.tw">sales@powertip.com.tw</a> Http://www.powertip.com.tw
---	--	--

## History of Version

<u>Date</u>	<u>Ver.</u>	<u>Edi.</u>	<u>Description</u>	<u>Page</u>	<u>Design by</u>
01/30/2018	01	001	New Drawing.	-	陳璐
06/07/2018	01	002	New Sample	-	陳璐
06/28/2018	01	003	Add Power Consumption	5	陳璐
02/22/2019	01	004	Modify RELIABILITY TEST	27	陳璐
06/14/2019	01	005	Modify Inspection Specification	20~21	陳璐
06/26/2019	01	006	Modify Interface Timings	16	陳璐
07/03/2019	01	007	Modify Interface Timings	16	陳璐
07/12/2019	01	008	Modify Interface Timings	16	陳璐
11/29/2019	02	009	Modify LCM Drawing	Appendix	陳璐
04/03/2020	03	010	Add TAPE	Appendix	陳璐
08/03/2021	03	011	Add Pixel Pitch	Appendix	陳璐
05/20/2022	04	012	Modify IC of BL Circuit	5,6	陳璐
10/21/2022	04	013	Modify LCM Mechanical Diagram	9	陳璐
			Modify PIN 27	10	
			Update Power Supply Characteristics	12	

Total: 28 Page

## Contents

### 1. SPECIFICATIONS

- 1.1 Features
- 1.2 Mechanical Specifications
- 1.3 Absolute Maximum Ratings
- 1.4 DC Electrical Characteristics
- 1.5 Optical Characteristics
- 1.6 Backlight Characteristics

### 2. MODULE STRUCTURE

- 2.1 Counter Drawing
- 2.2 Interface Pin Description
- 2.3 Timing Characteristics

### 3. QUALITY ASSURANCE SYSTEM

- 3.1 Quality Assurance Flow Chart
- 3.2 Inspection Specification

### 4. RELIABILITY TEST

- 4.1 Reliability Test Condition

### 5. PRECAUTION RELATING PRODUCT HANDLING

- 5.1 Safety
- 5.2 Handling
- 5.3 Storage
- 5.4 Terms of Warranty

- Appendix : 1. LCM Drawing.  
2. Packaging

## 1. SPECIFICATIONS

### 1.1 Features

<u>Item</u>	<u>Standard Value</u>
Screen size(Inch)	10.1(Diagonal)
Resolution	1280* (R、G、B) * 800 Dots
Display mode	Transmissive, Normally Black
Color	16.7M
Interface	8 bit LVDS
ROHS	THIS PRODUCT CONFORMS THE ROHS OF PTC Detail information please refer website : <a href="http://www.powertip.com.tw/news_detail.php?Key=1&amp;Cid=1">http://www.powertip.com.tw/news_detail.php?Key=1&amp;Cid=1</a>

### 1.2 Mechanical Specifications

<u>Item</u>	<u>Standard Value</u>	<u>Unit</u>
Outline Dimension	229.8(W) * 149 (L) * 10.0 (H)Max	mm

#### LCD panel

<u>Item</u>	<u>Standard Value</u>	<u>Unit</u>
Active Area	216.96 (W) * 135.60 (L)	mm

Note : For detailed information please refer to LCM drawing.

### 1.3 Absolute Maximum Ratings

Item	Symbol	Condition	Min.	Max.	Unit
Power Supply Voltage	VDD	-	-0.3	+4.0	V
Power Supply Voltage	LED_VCC	-	-0.3	+27	V
Operating Temperature	T <sub>OP</sub> (Ts)	Note 1	-30	+80	°C
Storage Temperature	T <sub>ST</sub> (Ta)	Note 2	-30	+80	°C
Storage Humidity	H <sub>D</sub>	Ta < 60 °C	10	90	%RH

The absolute maximum rating values of this product are not allowed to be exceeded at any times. Should a module be used with any of the absolute maximum ratings exceeded, the characteristics of the module may not be recovered, or in an extreme case, the module may be permanently destroyed.

Note 1 : Ts is the temperature of panel's surface.

Note 2 : Ta is the ambient temperature of samples.

### 1.4 DC Electrical Characteristics

Item	Symbol	Condition	Min.	Typ.	Max.	Unit
Power Supply Voltage for LCD Driver	VDD	-	2.75	3.3	3.6	V
Power Supply Voltage for LED Driver	LED_VCC	-	8.0	12.0	15.0	V
Power Supply Current	IDD	VDD=3.3V	-	400	600	mA
Power Supply Current For LED Driver	I <sub>LED_VCC</sub>	LED_VCC =12V	-	650	700	mA
Power Consumption (non-Touch Panel)	Pd	VDD=3.3V LED_VCC =12V	-	-	1.98+8.4	W
PWM Signal Voltage	VPWM	High	-	1.9	-	V
		Low	-	-	0.8	V
LED Enable Voltage	V <sub>LED_EN</sub>	High	-	1.9	-	V
		Low	-	-	0.8	V
LED PWM Frequency	FPWM	-	100	-	20000	Hz

## 1.5 Optical Characteristics

### TFT LCD Panel

Ta=25°C

Item	Symbol	Condition	Min.	Typ.	Max.	Unit	-	
Response time	Tr + Tf	-	-	25	50	ms	Note2	
Viewing angle	Top	ΘY+	CR ≥ 10	-	85	-	Deg.	Note4
	Bottom	ΘY-		-	85	-		
	Left	ΘX-		-	85	-		
	Right	ΘX+		-	85	-		
Contrast ratio	CR		600	800	-	-	Note3	
Color of CIE Coordinate (With B/L )	White	X	If=200mA	0.25	0.30	0.35	-	Note1
		Y		0.30	0.35	0.40		
	Red	X		0.55	0.60	0.65		
		Y		0.29	0.34	0.39		
	Green	X		0.27	0.32	0.37		
		Y		0.54	0.59	0.64		
	Blue	X		0.10	0.15	0.20		
		Y		0.10	0.15	0.20		
Average Brightness Pattern=white display (With B/L)	IV	If=200mA	730	1000	-	cd/m2	Note1	
Luminance uniformity	YU	-	70	-	-	%	Note1	

Note1:

1 :  $\Delta B = B(\min) / B(\max) \times 100\%$

2 : Measurement Condition for Optical Characteristics:

a : Environment: 25°C ± 5°C / 60 ± 20% R.H , no wind , dark room below 10 Lux at typical lamp current and typical operating frequency.

b : Measurement Distance: 500 ± 50 mm , (θ = 0°)

c : Equipment: TOPCON BM-7 fast , (field 1°) , after 10 minutes operation.

d : The uncertainty of the C.I.E coordinate measurement ± 0.01 , Average Brightness ± 4%

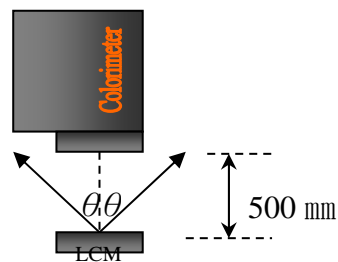
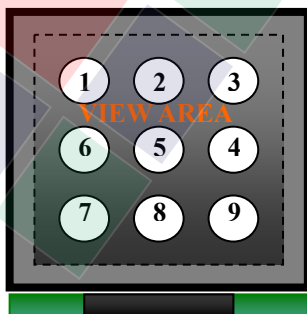

Colorimeter=BM-7 fast

Note2: Definition of response time:

The output signals of photo detector are measured when the input signals are changed from "black" to "white"(falling time) and from "white" to "black"(rising time), respectively. The response time is defined as the time interval between the 10% and 90% of Amplitudes.

Refer to figure as below:

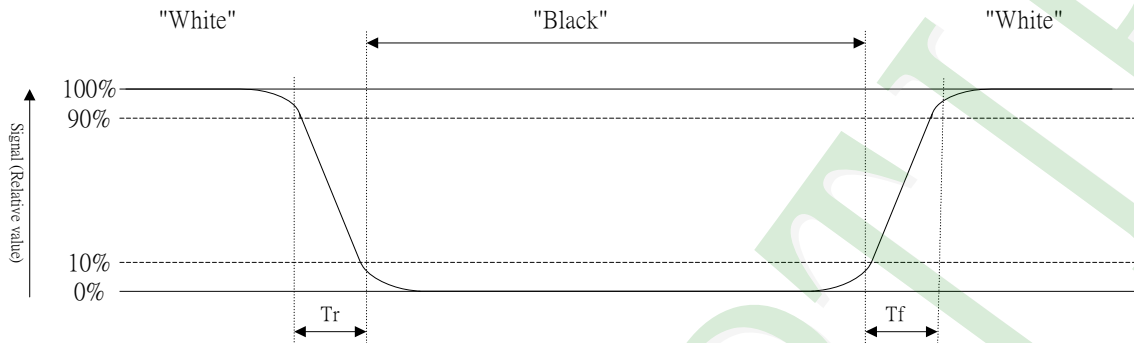

Note3: Definition of contrast ratio:

Contrast ratio is calculated with the following formula

$$\text{Contrast ratio (CR)} = \frac{\text{Photo detector output when LCD is at "White" state}}{\text{Photo detector output when LCD is at "Black" state}}$$

Note4: Definition of viewing angle:

Refer to figure as below:

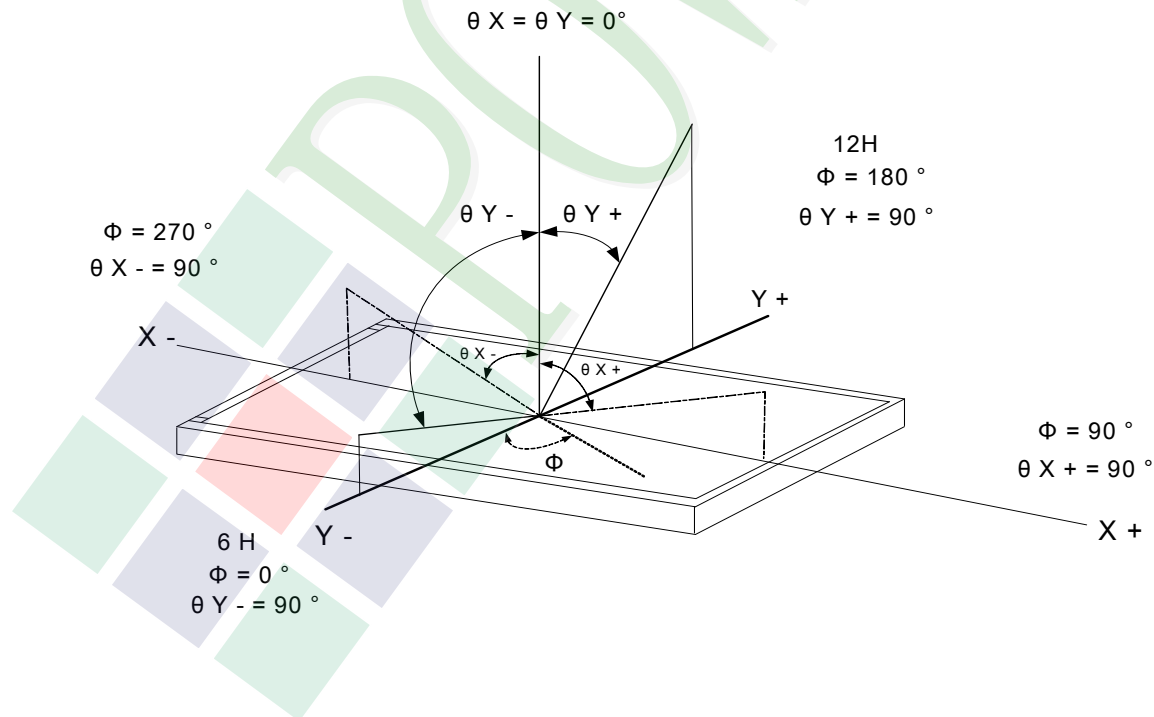

## 1.6 Backlight Characteristics

### Maximum Ratings

Item	Symbol	Conditions	Min.	Typ.	Max.	Unit
Power Dissipation	Pd	1 LED	-	-	306	mW
LED Forward Current	IF		-	-	90	mA
LED Reverse Voltage	VR		-	-	0.5	V

### Electrical / Optical Characteristics

Item	Symbol	Conditions	Min.	Typ.	Max.	Unit
Voltage for LED Backlight	VF	If=200mA	26	28	30	V
Current for LED Backlight	IF		-	200	-	mA
Color	White					

### Internal Circuit Diagram

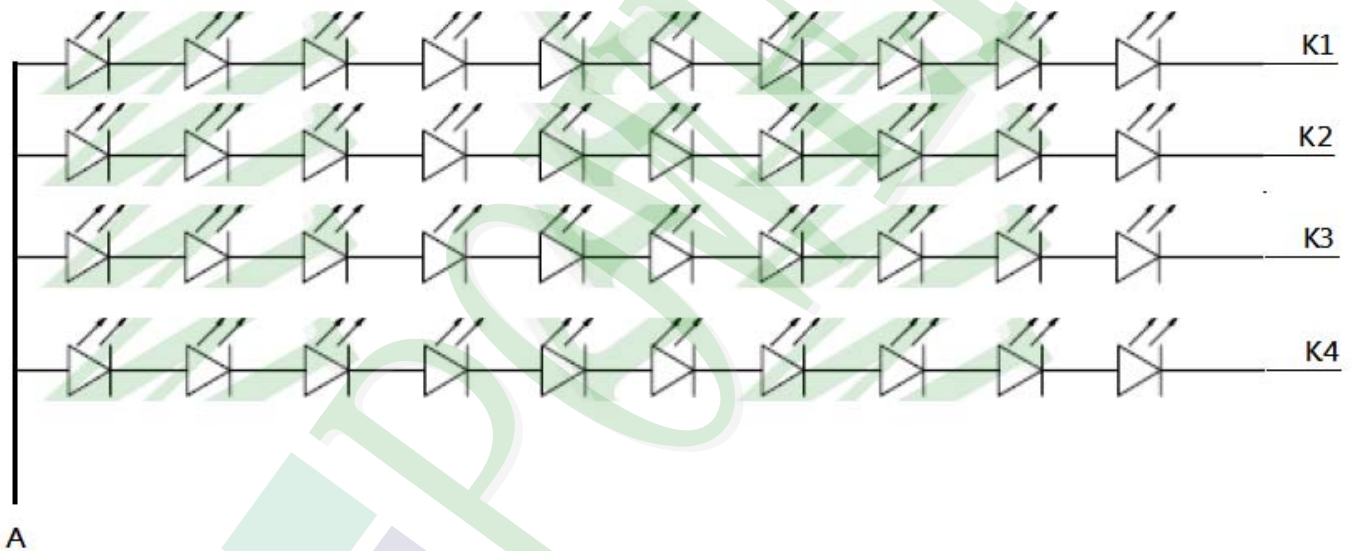

### Other Description

Item	Conditions	Description
Life Time	Ta =25°C IF= 200mA	70000 hrs



## 2. MODULE STRUCTURE

### 2.1 Counter Drawing

#### 2.1.1 LCM Mechanical Diagram

\* See Appendix

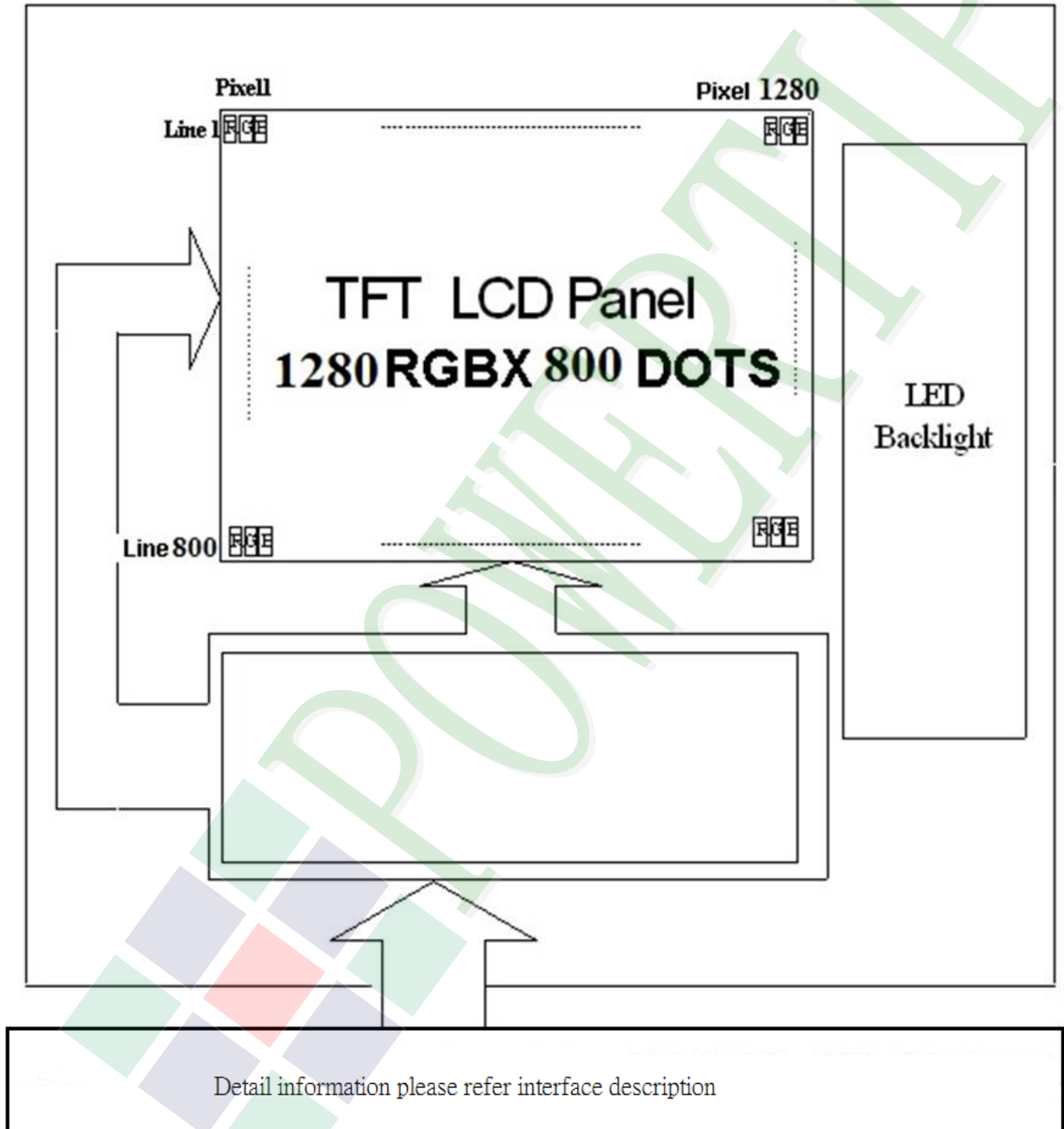

PIN1 ----- PIN40

## 2.2 Interface Pin Description

<u>Pin No.</u>	<u>Symbol</u>	<u>Description</u>
1	NC	No Connection.
2	VDD	Power Supply.
3	VDD	Power Supply.
4	NC	No Connection.
5	NC	No Connection.
6	NC	No Connection.
7	NC	No Connection.
8	LV0N	-LVDS Differential Data Input.
9	LV0P	+LVDS Differential Data Input.
10	GND	Ground.
11	LV1N	-LVDS Differential Data Input.
12	LV1P	+LVDS Differential Data Input.
13	GND	Ground.
14	LV2N	-LVDS Differential Data Input.
15	LV2P	+LVDS Differential Data Input.
16	GND	Ground.
17	LVCLKN	-LVDS Differential Clock Input.
18	LVCLKP	+LVDS Differential Clock Input.
19	GND	Ground.
20	LV3N	-LVDS Differential Data Input.
21	LV3P	+LVDS Differential Data Input.
22	GND	Ground.
23	LED_GND	Ground for LED Driving
24	LED_GND	Ground for LED Driving
25	LED_GND	Ground for LED Driving
26	NC	No Connection.
27	LED_PWM	LED Backlight PWM control signal for dimming.

<u>Pin No.</u>	<u>Symbol</u>	<u>Description</u>
28	LED_EN	LED Backlight Enable Input.
29	NC	No Connection.
30	NC	No Connection.
31	LED_VCC	Power Supply for LED Backlight driving.
32	LED_VCC	Power Supply for LED Backlight driving.
33	LED_VCC	Power Supply for LED Backlight driving.
34	NC	No Connection.
35	NC	No Connection.
36	NC	No Connection.
37	NC	No Connection.
38	NC	No Connection.
39	NC	No Connection.
40	NC	No Connection.

## 2.3 Power Supply Characteristics

### 2.3.1 POWER SUPPLY FOR LCM

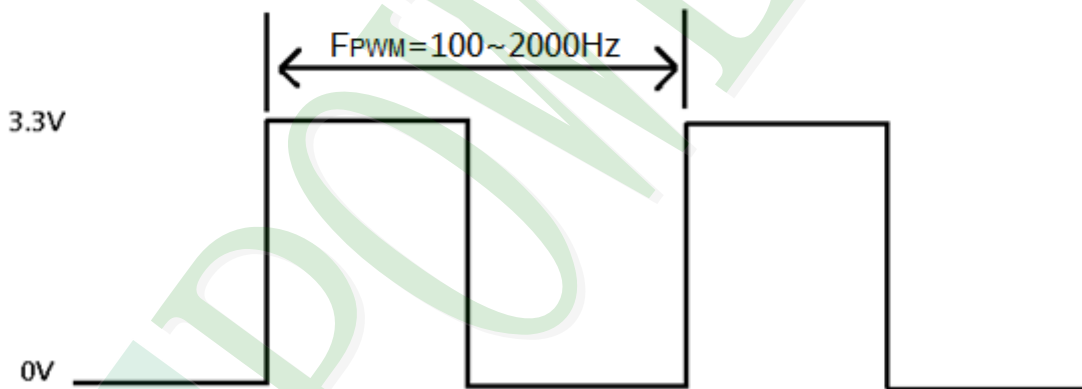
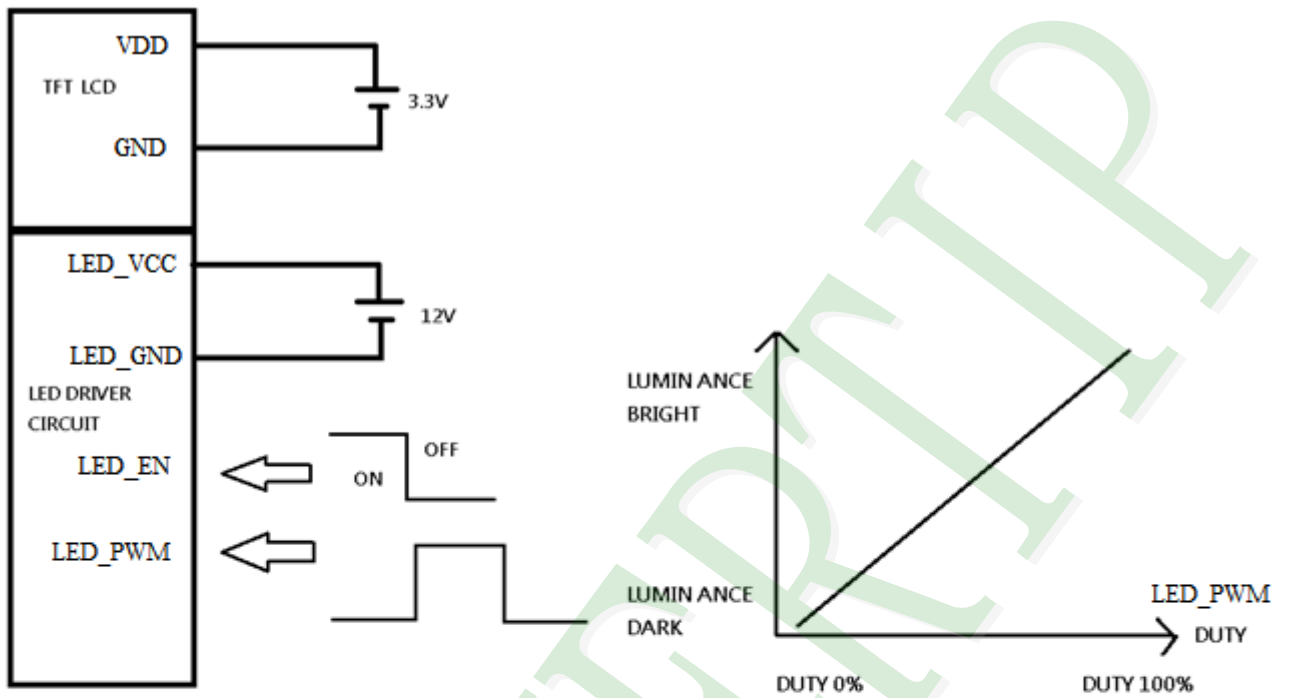

### 2.3.2 POWER ,SIGNAL SEQUENCE

- $0.5 < t_1 \leq 10\text{ms}$      $200\text{ms} \leq t_5$
- $0 < t_2 \leq 50\text{ms}$      $200\text{ms} \leq t_6$
- $0 < t_3 \leq 50\text{ms}$      $200\text{ms} \leq t_7$
- $0 < t_4 \leq 10\text{ms}$

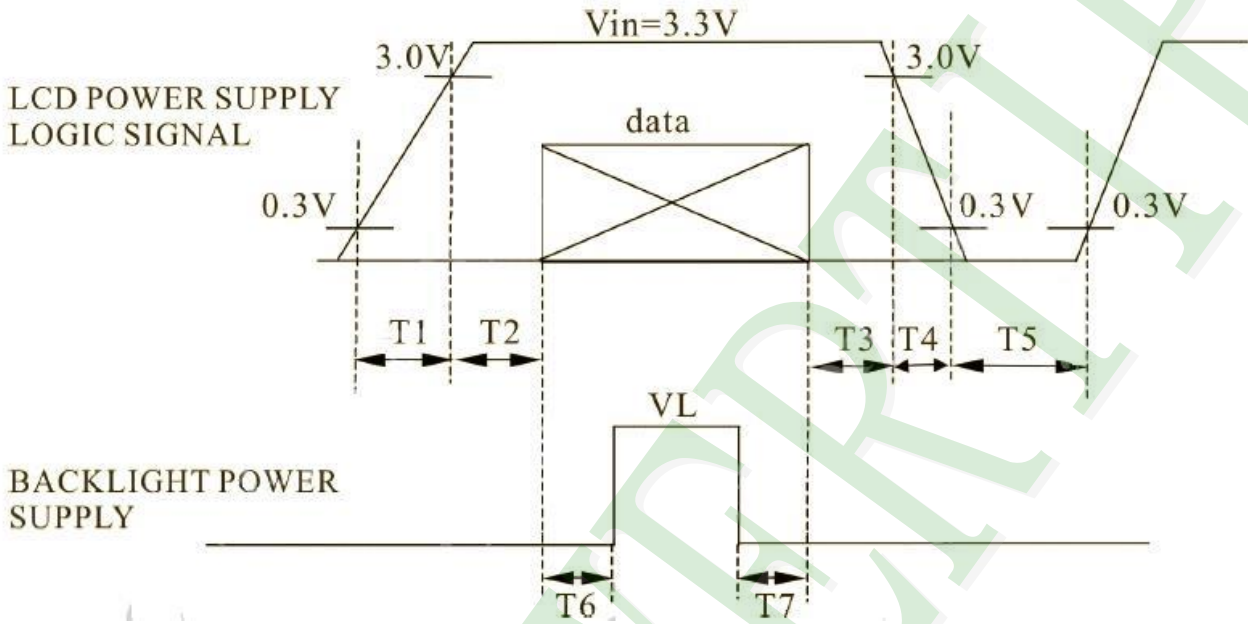

## 2.4 Timing Characteristics

### 2.4.1 LVDS Signal Timing Characteristics

#### DC Characteristics

Symbol	Parameter	Conditions	Min	Typ	Max	Unit
$V_{TH}$	Differential Input High Threshold	$V_{CM} = +1.2V$	-	-	100	mV
$V_{TL}$	Differential Input Low Threshold		-100	-	-	mV
$I_{CC}$	Average Supply Current		-	TBD	-	mA

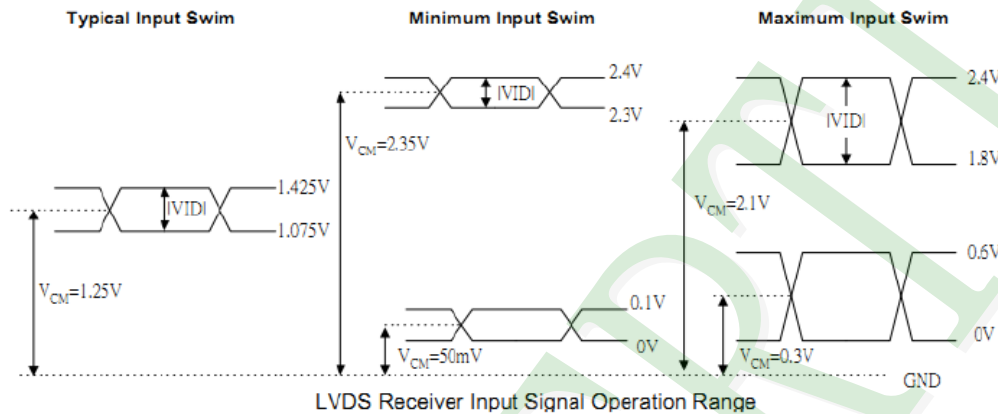

#### AC Characteristics

Symbol	Parameter	Conditions	Min	Typ	Max	Unit
$F_{OP}$	Input Operating Frequency range	RX_HF=0	25	-	100	MHz
		RX_HF=1	100	-	170	MHz
$R_{SKM}$	Receiver Skew Margin	85MHz, $ VID =400mV$ , $V_{CM}=1.2V$	450	-	-	pS
		150MHz, $ VID =400mV$ , $V_{CM}=1.2V$	267	-	-	pS
$T_{STRAT}$	Receiver startup time (after a valid LVDS clock is applied)		-	-	10	mS

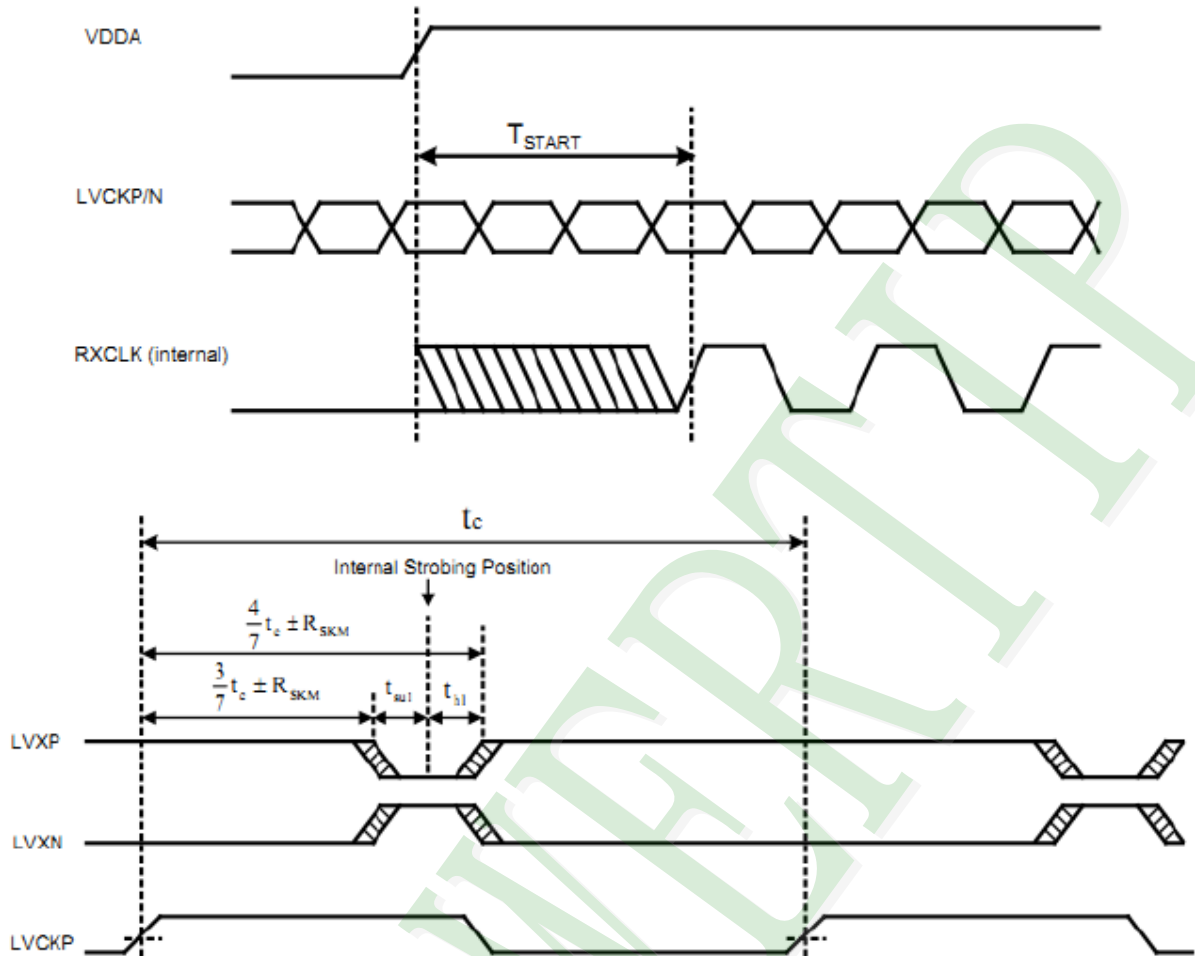

NOTE: LVCK is advanced or delayed with respect to data until errors are observed at the receiver outputs. The advance or delay is then reduced until there are no data errors observed. The magnitude of the advance or delay is RSKM.

## 2.4.2 LVDS Data Input Format

### 8-BIT LVDS INPUT

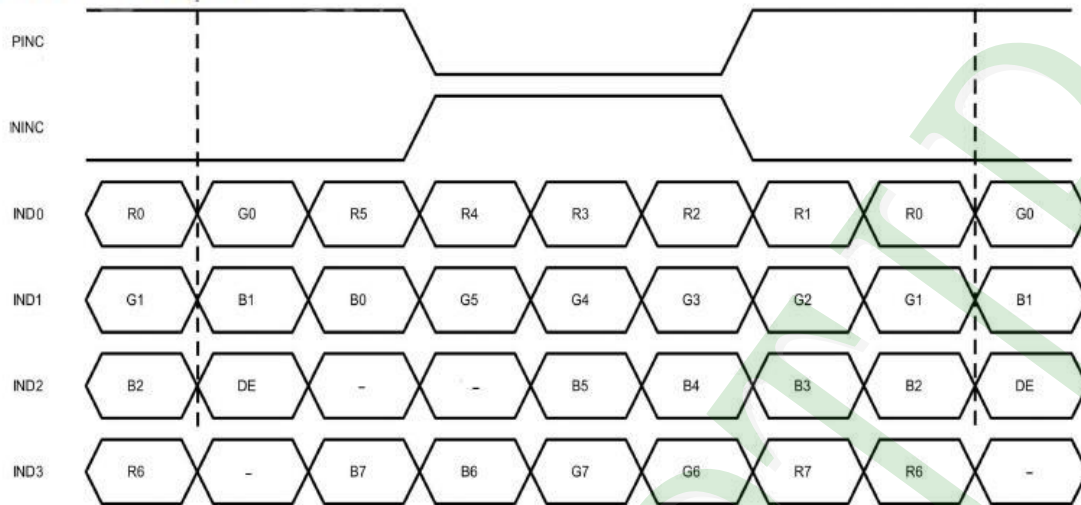

## 2.4.3 Interface Timings

Parameter	Symbol	Unit	Min.	Typ.	Max.
Frame Rate	--	Hz	-	60	-
Frame Period	$t_V$	line	(815)	(823)	(1023)
Vertical Display Time	$t_{VD}$	line	800		
Vertical Blanking Time	$t_{VW}+t_{VBP}+t_{VFP}$	line	(15)	(23)	(33)
1 Line Scanning Time	$t_H$	clock	(1410)	(1440)	(1470)
Horizontal Display Time	$t_{HD}$	clock	1280		
Horizontal Blanking Time	$t_{HW}+t_{HBP}+t_{HFP}$	clock	(60)	(160)	(190)
Clock Rate	$1/T_C$	MHz	(68.9)	(71.1)	(73.4)



### 2.4.4 Timing Diagram of Interface Signal (DE mode)

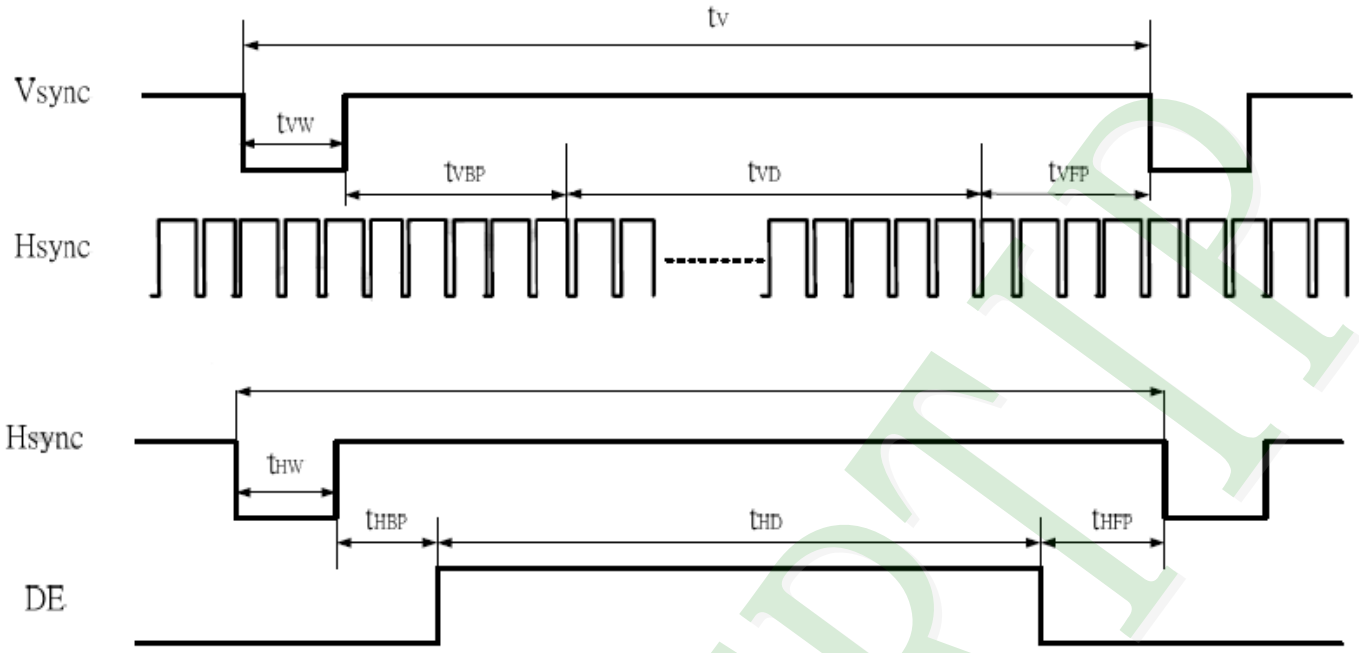

### 3. QUALITY ASSURANCE SYSTEM

#### 3.1 Quality Assurance Flow Chart

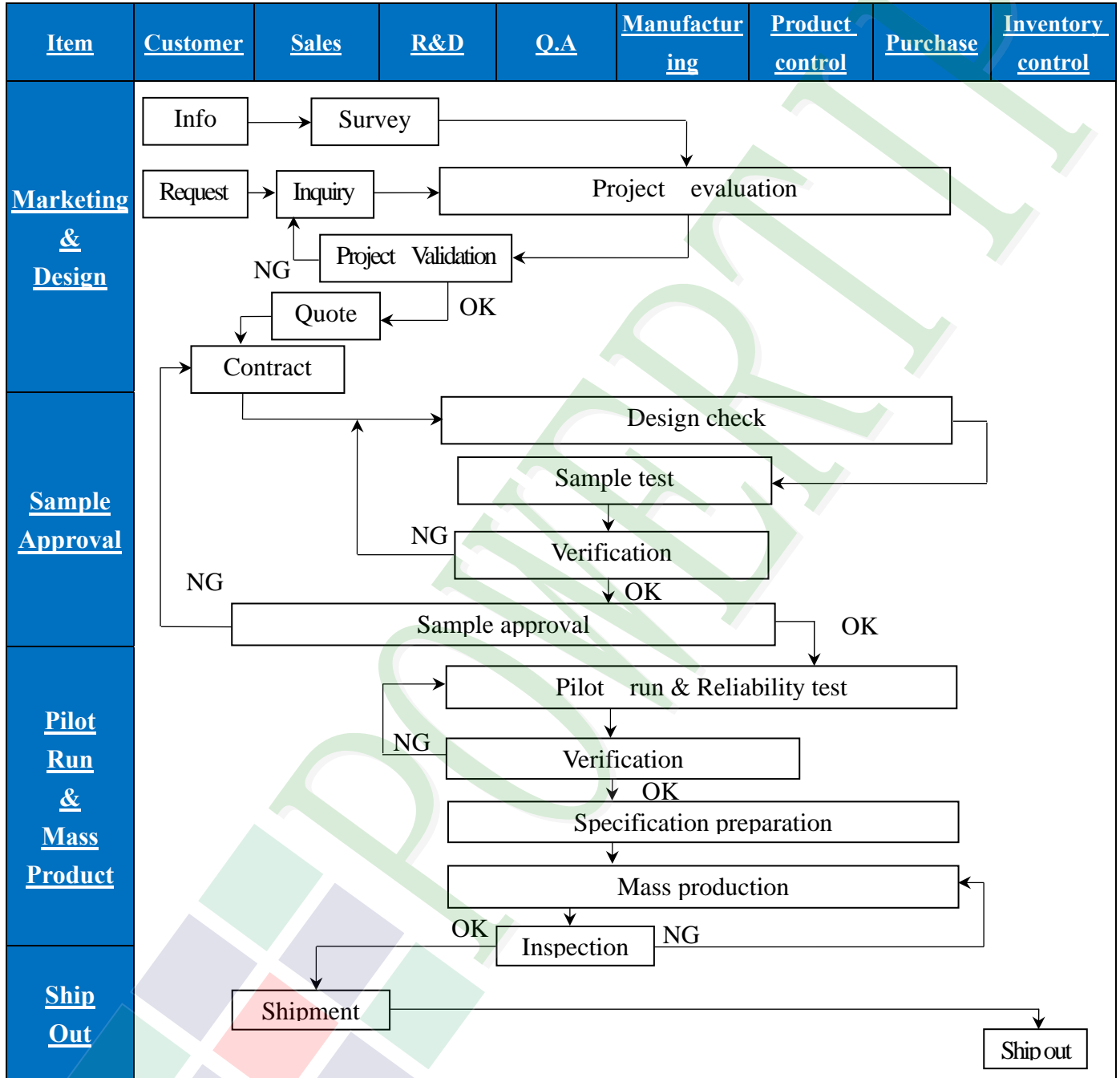

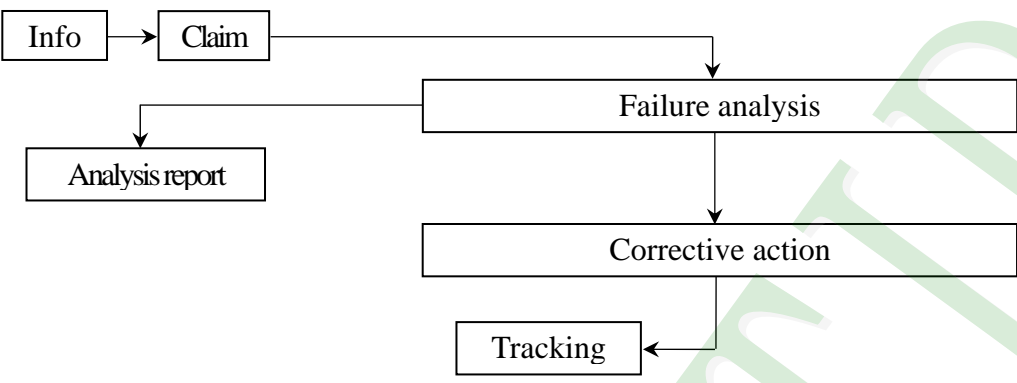
<u>Item</u>	<u>Customer</u>	<u>Sales</u>	<u>R&amp;D</u>	<u>Q.A</u>	<u>Manufacturing</u>	<u>Product control</u>	<u>Purchase</u>	<u>Inventory control</u>
<u>Sales Service</u>	 <pre> graph TD     Info[Info] --&gt; Claim[Claim]     Claim --&gt; Failure[Failure analysis]     Failure --&gt; Report[Analysis report]     Failure --&gt; Action[Corrective action]     Action --&gt; Tracking[Tracking]           </pre>							
<u>Q.A Activity</u>	1. ISO 9001 Maintenance Activities 3. Equipment calibration 5. Standardization Management				2. Process improvement proposal 4. Education And Training Activities			

### 3.2. Inspection Specification

- ◆Scope: The document shall be applied to TFT-LCD Module for 3.5" -15" (Ver.B01).
- ◆Inspection Standard: MIL-STD-105E Table Normal Inspection Single Sampling Level II.
- ◆Equipment: Gauge, MIL-STD, Powertip Tester, Sample
- ◆Defect Level: Major Defect AQL: 0.4; Minor Defect AQL: 1.5
- ◆OUT Going Defect Level: Sampling.
- ◆Standard of the product appearance test:

#### a. Manner of appearance test:

- (1). The test best be under 20W×2 fluorescent light(about 300lux ~500lux)  
, and distance of view must be at 30~40 cm.
- (2). The test direction is base on about around 45° of vertical line.

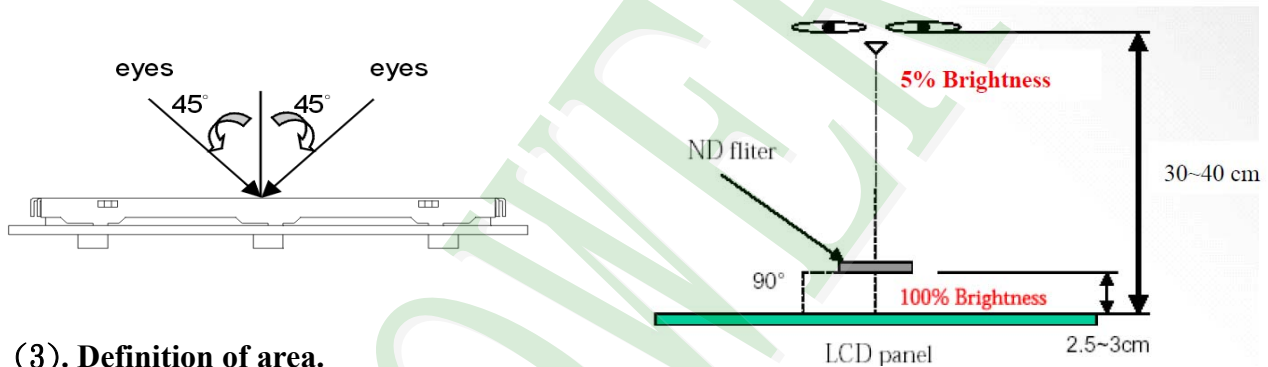

#### (3). Definition of area.

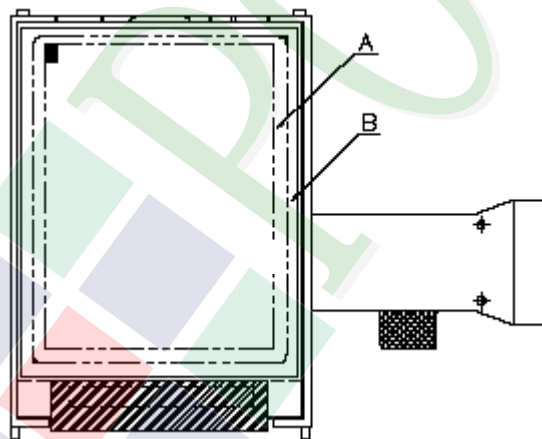

**A area: viewing area**

**B area: Outside of viewing area**

#### (4). Standard of inspection : (Unit : mm)

◆Specification For TFT-LCD Module 3.5” ~15” :

(Ver.B01)

NO	Item	Criterion	Level										
01	Product condition	1. 1The part number is inconsistent with work order of production.	Major										
		1. 2 Mixed product types.	Major										
		1. 3 Assembled in inverse direction.	Major										
02	Quantity	2. 1The quantity is inconsistent with work order of production.	Major										
03	Outline dimension	3. 1Product dimension and structure must conform to structure diagram.	Major										
04	Electrical Testing	4. 1 Missing line character and icon.	Major										
		4. 2 No function or no display.	Major										
		4. 3 Display malfunction.	Major										
		4. 4 LCD viewing angle defect.	Major										
		4. 5 Current consumption exceeds product specifications.	Major										
		4. 6Mura cannot be seen through 5% ND filter at 50% Gray , should be judged by the viewing angle of 90 degree.	Minor										
05	Dot defect (Bright dot, Dark dot)  On -display	<table border="1" data-bbox="561 1160 1273 1438"> <thead> <tr> <th>Item</th> <th>Acceptance (Q'ty)</th> </tr> </thead> <tbody> <tr> <td>Bright Dot</td> <td>≤ 4</td> </tr> <tr> <td>Dark Dot</td> <td>≤ 5</td> </tr> <tr> <td>Joint Dot</td> <td>≤ 3</td> </tr> <tr> <td>Total</td> <td>≤ 7</td> </tr> </tbody> </table>	Item	Acceptance (Q'ty)	Bright Dot	≤ 4	Dark Dot	≤ 5	Joint Dot	≤ 3	Total	≤ 7	Minor
		Item	Acceptance (Q'ty)										
Bright Dot	≤ 4												
Dark Dot	≤ 5												
Joint Dot	≤ 3												
Total	≤ 7												
5.1 Inspection pattern: full white, full black, Red, Green and blue screens. 5.2 It is defined as dot defect if defect area > 1/2 dot. 5.3 The distance between two dot defect ≥ 5 mm. 5.4 Bright dot : Dots appear bright and unchanged in visible with 5% ND filter is defined. 5.5 Tiny bright dot: bright dot area ≤ 1/2 dot. a. Dots appear bright and unchanged in visible with 5% ND filter is defined defect and is judged in accordance with 6.1 b. Dots invisible with 5% ND Filter is Ignored.													

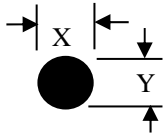
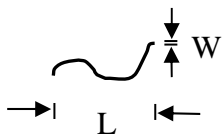
NO	Item	Criterion	Level																																																							
06	<p>Black or white Dot, scratch, contamination</p> <p>Round type</p>  $\Phi = (x + y) / 2$ <p>Line type</p> 	<p>6.1 Round type (Non-display or display):</p> <table border="1" data-bbox="512 416 1289 696"> <thead> <tr> <th rowspan="2">Dimension (diameter : <math>\Phi</math>)</th> <th colspan="2">Acceptance (Q'ty)</th> </tr> <tr> <th>A area</th> <th>B area</th> </tr> </thead> <tbody> <tr> <td><math>\Phi \leq 0.25</math></td> <td>Ignore</td> <td rowspan="4">Ignore</td> </tr> <tr> <td><math>0.25 &lt; \Phi \leq 0.50</math></td> <td>5</td> </tr> <tr> <td><math>\Phi &gt; 0.50</math></td> <td>0</td> </tr> <tr> <td><b>Total</b></td> <td><b>5</b></td> </tr> </tbody> </table> <p>6.2 Line type(Non-display or display):</p> <table border="1" data-bbox="432 813 1366 1352"> <thead> <tr> <th rowspan="2">module size</th> <th rowspan="2">Length (L)</th> <th rowspan="2">Width (W)</th> <th colspan="2">Acceptance (Q'ty)</th> </tr> <tr> <th>A area</th> <th>B area</th> </tr> </thead> <tbody> <tr> <td rowspan="4">3.5" to less 9"</td> <td>---</td> <td><math>W \leq 0.03</math></td> <td>Ignore</td> <td rowspan="4">Ignore</td> </tr> <tr> <td><math>L \leq 10.0</math></td> <td><math>0.03 &lt; W \leq 0.05</math></td> <td>4</td> </tr> <tr> <td><math>L \leq 5.0</math></td> <td><math>0.05 &lt; W \leq 0.10</math></td> <td>2</td> </tr> <tr> <td>---</td> <td><math>W &gt; 0.10</math></td> <td>As round type</td> </tr> <tr> <td colspan="3"><b>Total</b></td> <td><b>5</b></td> <td></td> </tr> <tr> <td rowspan="4">9" to 15"</td> <td>---</td> <td><math>W \leq 0.05</math></td> <td>Ignore</td> <td rowspan="4">Ignore</td> </tr> <tr> <td><math>L \leq 10.0</math></td> <td><math>0.05 &lt; W \leq 0.10</math></td> <td>5</td> </tr> <tr> <td>---</td> <td><math>W &gt; 0.10</math></td> <td>As round type</td> </tr> <tr> <td colspan="3"><b>Total</b></td> <td><b>5</b></td> </tr> </tbody> </table>	Dimension (diameter : $\Phi$ )	Acceptance (Q'ty)		A area	B area	$\Phi \leq 0.25$	Ignore	Ignore	$0.25 < \Phi \leq 0.50$	5	$\Phi > 0.50$	0	<b>Total</b>	<b>5</b>	module size	Length (L)	Width (W)	Acceptance (Q'ty)		A area	B area	3.5" to less 9"	---	$W \leq 0.03$	Ignore	Ignore	$L \leq 10.0$	$0.03 < W \leq 0.05$	4	$L \leq 5.0$	$0.05 < W \leq 0.10$	2	---	$W > 0.10$	As round type	<b>Total</b>			<b>5</b>		9" to 15"	---	$W \leq 0.05$	Ignore	Ignore	$L \leq 10.0$	$0.05 < W \leq 0.10$	5	---	$W > 0.10$	As round type	<b>Total</b>			<b>5</b>	Minor
Dimension (diameter : $\Phi$ )	Acceptance (Q'ty)																																																									
	A area	B area																																																								
$\Phi \leq 0.25$	Ignore	Ignore																																																								
$0.25 < \Phi \leq 0.50$	5																																																									
$\Phi > 0.50$	0																																																									
<b>Total</b>	<b>5</b>																																																									
module size	Length (L)	Width (W)	Acceptance (Q'ty)																																																							
			A area	B area																																																						
3.5" to less 9"	---	$W \leq 0.03$	Ignore	Ignore																																																						
	$L \leq 10.0$	$0.03 < W \leq 0.05$	4																																																							
	$L \leq 5.0$	$0.05 < W \leq 0.10$	2																																																							
	---	$W > 0.10$	As round type																																																							
<b>Total</b>			<b>5</b>																																																							
9" to 15"	---	$W \leq 0.05$	Ignore	Ignore																																																						
	$L \leq 10.0$	$0.05 < W \leq 0.10$	5																																																							
	---	$W > 0.10$	As round type																																																							
	<b>Total</b>				<b>5</b>																																																					
07	Polarizer Bubble	<table border="1" data-bbox="477 1494 1323 1917"> <thead> <tr> <th rowspan="2">Dimension (diameter: <math>\Phi</math>)</th> <th colspan="2">Acceptance (Q'ty)</th> </tr> <tr> <th>A area</th> <th>B area</th> </tr> </thead> <tbody> <tr> <td><math>\Phi \leq 0.25</math></td> <td>Ignore</td> <td rowspan="5">Ignore</td> </tr> <tr> <td><math>0.25 &lt; \Phi \leq 0.50</math></td> <td>4</td> </tr> <tr> <td><math>0.50 &lt; \Phi \leq 0.80</math></td> <td>1</td> </tr> <tr> <td><math>\Phi &gt; 0.80</math></td> <td>0</td> </tr> <tr> <td><b>Total</b></td> <td><b>5</b></td> </tr> </tbody> </table>	Dimension (diameter: $\Phi$ )	Acceptance (Q'ty)		A area	B area	$\Phi \leq 0.25$	Ignore	Ignore	$0.25 < \Phi \leq 0.50$	4	$0.50 < \Phi \leq 0.80$	1	$\Phi > 0.80$	0	<b>Total</b>	<b>5</b>	Minor																																							
Dimension (diameter: $\Phi$ )	Acceptance (Q'ty)																																																									
	A area	B area																																																								
$\Phi \leq 0.25$	Ignore	Ignore																																																								
$0.25 < \Phi \leq 0.50$	4																																																									
$0.50 < \Phi \leq 0.80$	1																																																									
$\Phi > 0.80$	0																																																									
<b>Total</b>	<b>5</b>																																																									

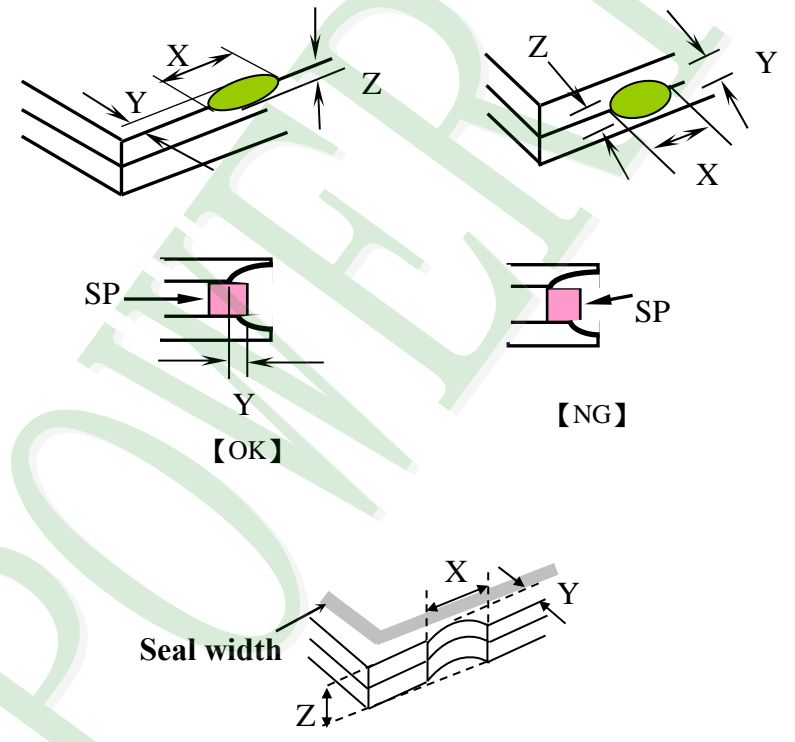
NO	Item	Criterion	Level						
08	The crack of glass	<p><b>Symbols :</b></p> <p><b>X:</b> The length of crack  <b>Z:</b> The thickness of crack  <b>t:</b> The thickness of glass</p> <p><b>Y:</b> The width of crack.  <b>W:</b> terminal length  <b>a:</b> LCD side length</p>	Minor						
		<p>8.1 General glass chip:              8.1.1 Chip on panel surface and crack between panels:</p>  <p>The diagrams illustrate various crack and chip scenarios. The top row shows two 3D views of a chip on the panel surface, with labels X (length), Y (width), and Z (thickness). The middle row shows two cross-sectional views of a crack between panels, with labels SP (sealant) and Y (width). The left view is labeled [OK] and the right view is labeled [NG]. The bottom diagram shows a cross-section of a panel edge with a crack, labeled with X, Y, Z, and Seal width.</p> <table border="1" data-bbox="539 1574 1353 1865"> <thead> <tr> <th><u>X</u></th> <th><u>Y</u></th> <th><u>Z</u></th> </tr> </thead> <tbody> <tr> <td><math>\cong a</math></td> <td>Crack can't enter viewing area</td> <td><math>\leq 1/2 t</math></td> </tr> <tr> <td><math>\cong a</math></td> <td>Crack can't exceed the half of SP width.</td> <td><math>1/2 t &lt; Z \leq 2 t</math></td> </tr> </tbody> </table>		<u>X</u>	<u>Y</u>	<u>Z</u>	$\cong a$	Crack can't enter viewing area	$\leq 1/2 t$
<u>X</u>	<u>Y</u>	<u>Z</u>							
$\cong a$	Crack can't enter viewing area	$\leq 1/2 t$							
$\cong a$	Crack can't exceed the half of SP width.	$1/2 t < Z \leq 2 t$							

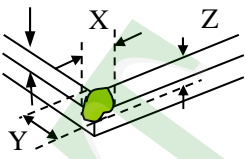
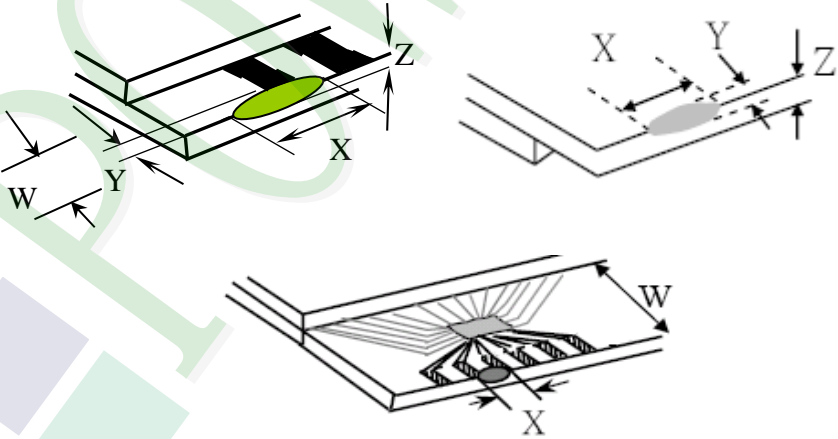
NO	Item	Criterion	Level												
08	The crack of glass	<p>Symbols :</p> <p><b>X:</b> The length of crack  <b>Z:</b> The thickness of crack  <b>t:</b> The thickness of glass</p> <p><b>Y:</b> The width of crack.  <b>W:</b> terminal length  <b>a:</b> LCD side length</p> <hr/> <p>8.1.2 Corner crack:</p>  <table border="1" data-bbox="520 763 1337 1055"> <thead> <tr> <th><u>X</u></th> <th><u>Y</u></th> <th><u>Z</u></th> </tr> </thead> <tbody> <tr> <td><math>\leq 1/5 a</math></td> <td>Crack can't enter viewing area</td> <td><math>Z \leq 1/2 t</math></td> </tr> <tr> <td><math>\leq 1/5 a</math></td> <td>Crack can't exceed the half of SP width.</td> <td><math>1/2 t &lt; Z \leq 2 t</math></td> </tr> </tbody> </table>	<u>X</u>	<u>Y</u>	<u>Z</u>	$\leq 1/5 a$	Crack can't enter viewing area	$Z \leq 1/2 t$	$\leq 1/5 a$	Crack can't exceed the half of SP width.	$1/2 t < Z \leq 2 t$				
		<u>X</u>	<u>Y</u>	<u>Z</u>											
$\leq 1/5 a$	Crack can't enter viewing area	$Z \leq 1/2 t$													
$\leq 1/5 a$	Crack can't exceed the half of SP width.	$1/2 t < Z \leq 2 t$													
		<p>8.2 Protrusion over terminal:</p> <p>8.2.1 Chip on electrode pad:</p>  <table border="1" data-bbox="560 1697 1347 1868"> <thead> <tr> <th></th> <th><u>X</u></th> <th><u>Y</u></th> <th><u>Z</u></th> </tr> </thead> <tbody> <tr> <td>Front</td> <td><math>\leq a</math></td> <td><math>\leq 1/2 W</math></td> <td><math>\leq t</math></td> </tr> <tr> <td>Back</td> <td><math>\leq a</math></td> <td><math>\leq W</math></td> <td><math>\leq 1/2 t</math></td> </tr> </tbody> </table>		<u>X</u>	<u>Y</u>	<u>Z</u>	Front	$\leq a$	$\leq 1/2 W$	$\leq t$	Back	$\leq a$	$\leq W$	$\leq 1/2 t$	Minor
	<u>X</u>	<u>Y</u>	<u>Z</u>												
Front	$\leq a$	$\leq 1/2 W$	$\leq t$												
Back	$\leq a$	$\leq W$	$\leq 1/2 t$												

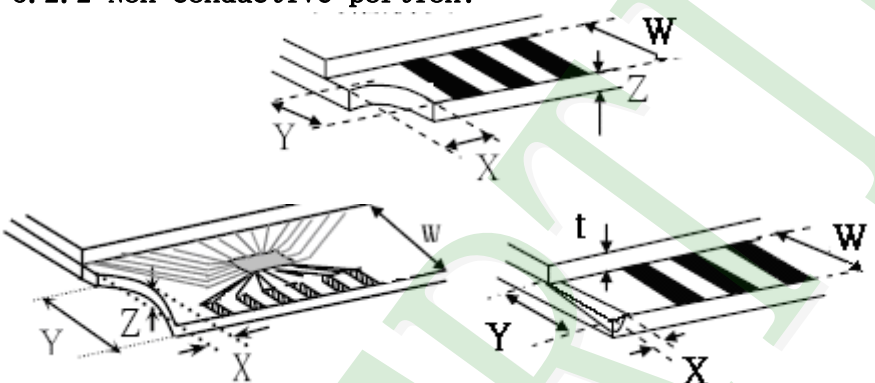
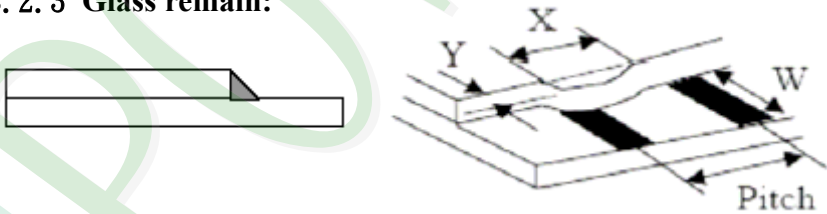
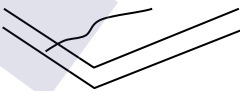

NO	Item	Criterion	Level												
08	The crack of glass	<p><b>Symbols:</b></p> <p><b>X:</b> The length of crack                      <b>Y:</b> The width of crack.  <b>Z:</b> The thickness of crack                  <b>W:</b> terminal length  <b>t:</b> The thickness of glass                  <b>a:</b> LCD side length</p> <hr/> <p><b>8.2.2 Non-conductive portion:</b></p>  <table border="1" data-bbox="625 958 1257 1084"> <thead> <tr> <th><u>X</u></th> <th><u>Y</u></th> <th><u>Z</u></th> </tr> </thead> <tbody> <tr> <td><math>\leq 1/3 a</math></td> <td><math>\leq W</math></td> <td><math>\leq t</math></td> </tr> </tbody> </table> <p>⊙ If the chipped area touches the ITO terminal, over 2/3 of the ITO must remain and be inspected according to electrode terminal specifications.</p> <p><b>8.2.3 Glass remain:</b></p>  <table border="1" data-bbox="545 1514 1238 1635"> <thead> <tr> <th><u>X</u></th> <th><u>Y</u></th> <th><u>Z</u></th> </tr> </thead> <tbody> <tr> <td><math>\leq a</math></td> <td><math>\leq 1/3 W</math></td> <td><math>\leq t</math></td> </tr> </tbody> </table> <p><b>8.2.4 Cracking:</b></p>  <p style="text-align: center;"><b>Not Allowed</b></p>	<u>X</u>	<u>Y</u>	<u>Z</u>	$\leq 1/3 a$	$\leq W$	$\leq t$	<u>X</u>	<u>Y</u>	<u>Z</u>	$\leq a$	$\leq 1/3 W$	$\leq t$	Minor
		<u>X</u>	<u>Y</u>	<u>Z</u>											
$\leq 1/3 a$	$\leq W$	$\leq t$													
<u>X</u>	<u>Y</u>	<u>Z</u>													
$\leq a$	$\leq 1/3 W$	$\leq t$													

**◆Specification For TFT-LCD Module 3.5" ~15" :**
**(Ver.B01)**

<u>NO</u>	<u>Item</u>	<u>Criterion</u>	<u>Level</u>
09	Backlight elements	9. 1 Backlight can't work normally.	Major
		9. 2 Backlight doesn't light or color is wrong.	Major
		9. 3 Illumination source flickers when lit.	Major
10	General appearance	10. 1 Pin type 、 quantity 、 dimension must match type in structure diagram.	Major
		10. 2 No short circuits in components on PCB or FPC.	Major
		10. 3 Parts on PCB or FPC must be: no wrong parts, missing parts or excess parts.	Major
		10. 4 Product packaging must the same as specified on packaging specification sheet.	Minor
		10. 5 The folding and peeled off in polarizer are not acceptable.	Minor
		10. 6 The PCB or FPC between B/L assembled distance(PCB or FPC ) is $\leq 1.5$ mm.	Minor



## 5. PRECAUTION RELATING PRODUCT HANDLING

### 5.1 SAFETY

- 5.1.1 If the LCD panel breaks, be careful not to get the liquid crystal to touch your skin.
- 5.1.2 If the liquid crystal touches your skin or clothes, please wash it off immediately by using soap and water.

### 5.2 HANDLING

- 5.2.1 Avoid any strong mechanical shock which can break the glass.
- 5.2.2 Avoid static electricity which can damage the CMOS LSI—When working with the module, be sure to ground your body and any electrical equipment you may be using.
- 5.2.3 Do not remove the panel or frame from the module.
- 5.2.4 The polarizing plate of the display is very fragile. So, please handle it very carefully, do not touch, push or rub the exposed polarizing with anything harder than an HB pencil lead (glass, tweezers, etc.)
- 5.2.5 Do not wipe the polarizing plate with a dry cloth, as it may easily scratch the surface of plate.
- 5.2.6 Do not touch the display area with bare hands, this will stain the display area.
- 5.2.7 Do not use ketonics solvent & aromatic solvent. Use with a soft cloth soaked with a cleaning naphtha solvent.
- 5.2.8 To control temperature and time of soldering is  $320 \pm 10^{\circ}\text{C}$  and 3-5 sec.
- 5.2.9 To avoid liquid (include organic solvent) stained on LCM
- 5.2.10 Caution!( LCM products with Capacitive Touch Panel)  
Strong EMI-sources such as switch-mode power supplies (SMPS) can lead to touch malfunction (e.g. ghost-touches).  
Therefore, the touch needs to be thoroughly tested inside the target application.
- 5.2.11 CAUTION: Continuously displaying same static image will result in high possibility of image sticking/image burn-in effect due to TFT panel characteristic.
- 5.2.12 Double-sided tape designed to be attach with the customer's mechanical device, please follow up the rules and regulations published by the original manufacturer of double-sided tape for the attachment operation.

### 5.3 STORAGE

- 5.3.1 Store the panel or module in a dark place where the temperature is  $25^{\circ}\text{C} \pm 5^{\circ}\text{C}$  and the humidity is below 65% RH.
- 5.3.2 Do not place the module near organics solvents or corrosive gases.
- 5.3.3 Do not crush, shake, or jolt the module.

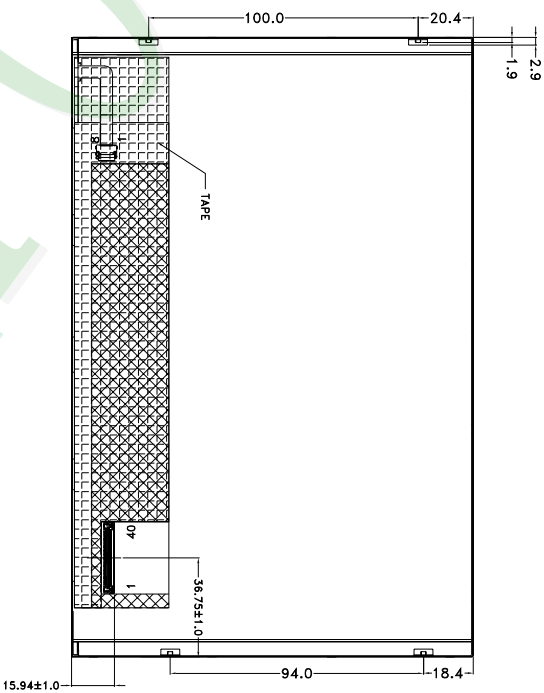
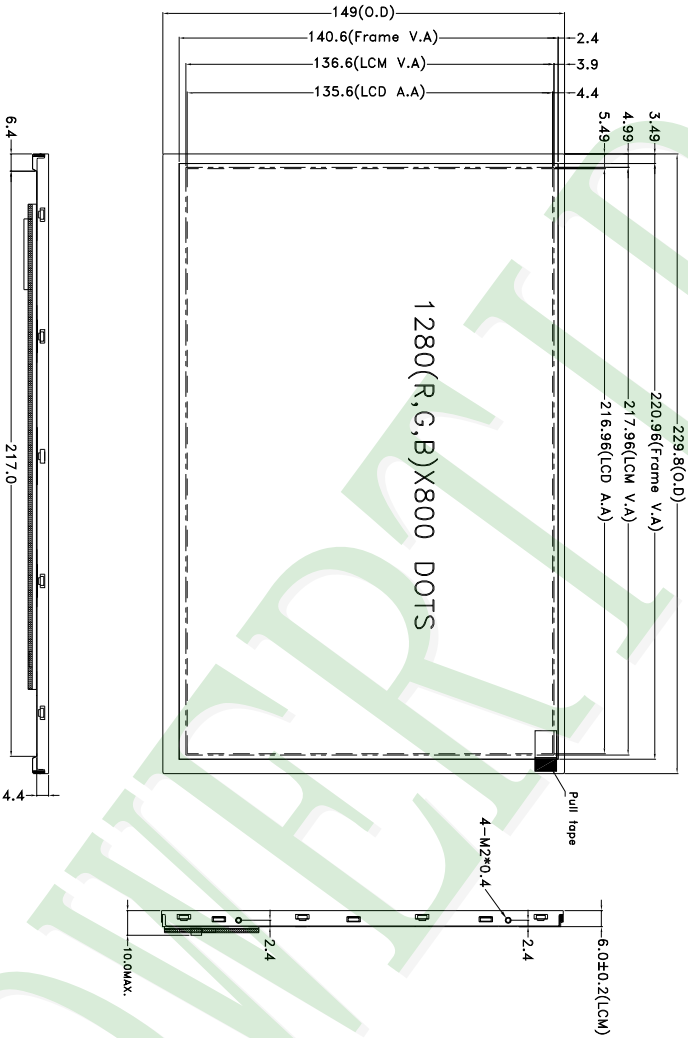

### 5.4 TERMS OF WARRANTY

- 5.4.1 Applicable warrant period The period is within thirteen months since the date of shipping out under normal using and storage conditions.
- 5.4.2 Unaccepted responsibility  
This product has been manufactured to your company's specification as a part for use in your company's general electronic products. It is guaranteed to perform according to delivery specifications. For any other use apart from general electronic equipment, we cannot take responsibility if the product is used in nuclear power control equipment, aerospace equipment, fire and security systems or any other applications in which there is a direct risk to human life and where extremely high levels of reliability are required.



NOTES:

- 1.LCD TYPE: TFT LCD
- 2.LCD DISPLAY: POSITIVE/TRANSMISSIVE
- 3.The tolerance unless classified ±0.3mm
- 4.Manufacturer/Type :Starcomn/300E40-0010RA-G3
- 5.Mating Receptacle/Type (Reference) :11B40-1211TA-G3 or Compatible

007																				
006	ADD PIXEL PITCH	Crystal	2021/07/30	PART NO:	PH128800T004-ZZA01	 久正光电股份有限公司 POWER TIP TECHNOLOGY CORPORATION	Crystal	 (3)	Surface	Material	Thickness	Quantity	Precision Level 1 ~ 4 4 ~ 16 16 ~ 63 63 ~ 250 250 ~ 1000							
005	ADD TAPE	Air	2020/04/02	DRAWING NAME :	JLMD-PH128800T004-ZZA01									Air	MM	1:1	1/1	-		
004	ADD DIM.	Air	2019/11/29																	
003	UPDATE BL&FC	Air	2019/11/22																	
002	UPDATE DRAWING	Air	2018/05/15	TITLE:	LCD MODULE DRAWING															
001	NEW DRAWING	Air	2018/01/31	REV BY	REVISER	DATE	DATE	DATE	DATE	DATE	DATE	DATE	DATE							

**1. 包裝材料規格表 (Packaging Material) : (per carton)**

No.	Item	Model	Dimensions (mm)	1Pcs Weight	Quantity	Total Weight
1	成品 (LCD)	PH128800T004-ZZA01	229.8 X 149 X 6.0	0.2271	18	4.0878
2	多層薄膜(1)POF	OTFILM0BA03ABA	—————	—————	3	—————
3	TRAY 盤 (2)Tray	TY00000000394	517 X 377 X 18.8	0.2	12	2.4
4	內盒(3)Product Box	BX00000000071	558 X 393 X 68	0.6	3	1.8
5	保利龍板(4)Polylon board	OTPLB00PL08ABA	550 X 393 X 20	0.0284	2	0.0568
6	外紙箱(5)Carton	BX57041027CCBA	570 X 410 X 265	1.0	1	1.0
7	舒美墊(6)EPE	OTFOAMEP0001BA	333X 218 X 2.0	0.0032	14	0.0448
8						
9						

2. 一整箱總重量 (Total LCD Weight in carton) : 9.39 Kg±10%

3. 單箱數量規格表 (Packaging Specifications and Quantity) :

(1)LCD quantity per box : no per tray	2	x no of tray	3	=	6
(2)Total LCD quantity in carton : quantity per box	6	x no of boxes	3	=	18

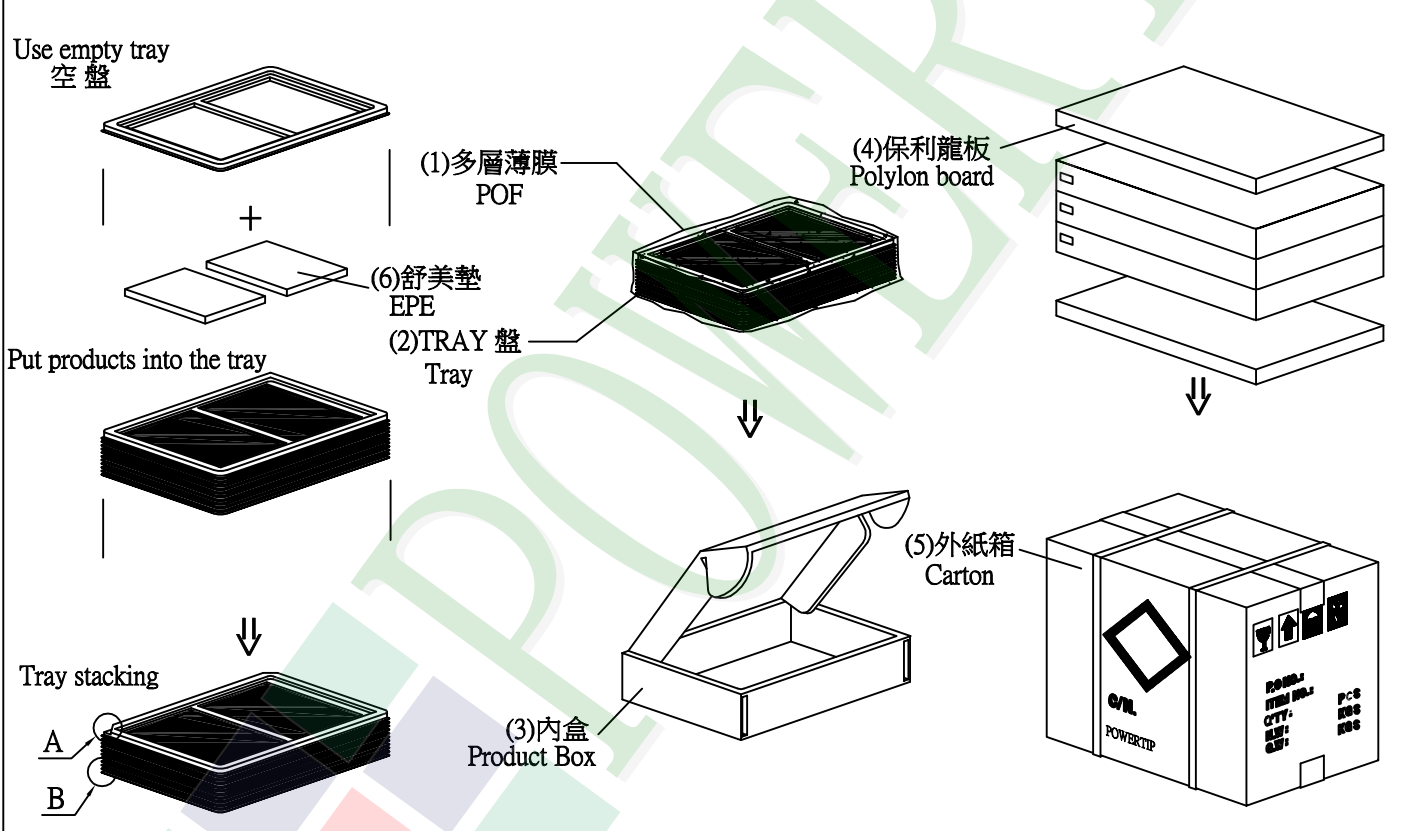

**特 記 事 項 (REMARK)**

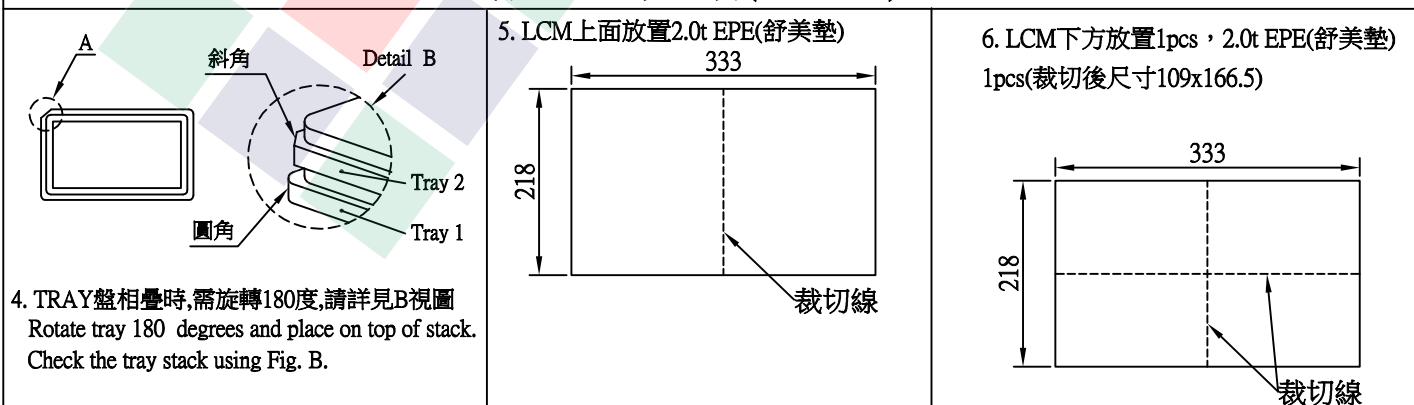

## X-ON Electronics

Largest Supplier of Electrical and Electronic Components

*Click to view similar products for [TFT Displays & Accessories category](#):*

*Click to view products by [Powertip manufacturer](#):*

Other Similar products are found below :

[OAI-80038AA-2013-A](#) [HDA430T-3G1H](#) [T-51750GD065J-LW-BGN](#) [NB-ATT01](#) [NL8060BC26-35C](#) [TCG104SVLQAPNN-AN20](#) [OAI-80038AA-2008-A](#) [315-U004B15300](#) [EIC-LCD-1080P](#) [NL10276BC20-18C](#) [NLB121XG01L-01](#) [DEM 128160D](#) [TMH-PW-N](#) [RFE43BU-AIW-DNG](#) [RFC350X-AWW-DNG](#) [RFS390E-AWW-DNN](#) [DEM 480272G2](#) [VMX-PW-N \(A-TOUCH\)](#) [PH800480T013-ICA](#) [DEM 1024600N](#) [VMX-PW-N \(C-TOUCH\)](#) [DEM 1024600P](#) [VMH-PW-N \(C-TOUCH\)](#) [SM-RVT50HQHNWCA0](#) [DEM 240280A](#) [VMH-PW-N](#) [DEM 170320A](#) [VMH-PW-N](#) [PH240320T068-LAB08](#) [DEM 800480T1](#) [TMH-PW-N](#) [PH128128T041-LAA07](#) [DEM 800480Q4](#) [VMX-PW-N \(A-TOUCH\)](#) [PH480272T005-IAC02](#) [DEM 1024600P](#) [VMH-PW-N \(A-TOUCH\)](#) [DEM 800480T1](#) [TMH-PW-N \(C-TOUCH\)](#) [DEM 800480Q4](#) [VMX-PW-N](#) [DEM 800480T1](#) [TMH-PW-N \(A-TOUCH\)](#) [PH320240T-023-I02Q](#) [PH128800T004-ZZA01](#) [RFE430W-1YW-DBS](#) [DEM 1024600N](#) [VMX-PW-N \(A-TOUCH\)](#) [PH240320T074-ZAA01](#) [DEM 480480D](#) [VMX-PW-N \(C-TOUCH\)](#) [SM-RVT50HQSNNWN00](#) [SM-RVT50HQHNWC00](#) [PH800480T033-ICB01](#) [RFE430W-AWW-DNN](#) [DEM 096096A](#) [VMH-PW-N](#) [RL0F00050000FGAAASA01](#) [PH320480T009-LAA01](#) [SM-RVT50HQSNNWCA0](#) [SM-RVT50HQSNNWC00-B](#) [PH320240T028-ZEA01](#) [RFE430W-1YW-DBN](#) [SM-RVT50HQLFWN00](#) [SM-RVT50HQHNWC00-B](#)