

SPECIFICATIONS

CUSTOMER	:	CDE012
SAMPLE CODE	:	SH128800T006-ZHC01
MASS PRODUCTION CODE	:	PH128800T006-ZHC01
SAMPLE VERSION	:	01
SPECIFICATIONS EDITION	:	003
DRAWING NO. (Ver.)	:	LMD-PH128800T006-ZHC01 (Ver.003)
PACKAGING NO. (Ver.)	:	PKG-PH128800T006-ZHC01 (Ver.001)

Customer Approved

Date:

Approved	Checked	Designer
廖志豪 Rex Liao	張慶源 Yuan Chang	黃丞毅 Ian Huang

- Preliminary specification for design input
- Specification for sample approval

POWER TIP TECH. CORP.

Headquarters:

No.8, 6th Road, Taichung Industrial Park,
Taichung, Taiwan
台中市 407 工業區六路 8 號

TEL: 886-4-2355-8168
FAX: 886-4-2355-8166

E-mail: sales@powertip.com.tw
[Http://www.powertip.com.tw](http://www.powertip.com.tw)

Contents

1. SPECIFICATIONS

- 1.1 Features
- 1.2 Mechanical Specifications
- 1.3 Absolute Maximum Ratings
- 1.4 DC Electrical Characteristics
- 1.5 Optical Characteristics
- 1.6 Backlight Unit Characteristics
- 1.7 Touch Panel Unit Characteristic

2. MODULE STRUCTURE

- 2.1 Counter Drawing
- 2.2 Interface Pin Description
- 2.3 Timing Characteristics

3. QUALITY ASSURANCE SYSTEM

- 3.1 Quality Assurance Flow Chart
- 3.2 Inspection Specification

4. RELIABILITY TEST

- 4.1 Reliability Test Condition

5. PRECAUTION RELATING PRODUCT HANDLING

- 5.1 Safety
- 5.2 Handling
- 5.3 Storage
- 5.4 Terms of Warranty

Appendix:

- 1. LCM Drawing
- 2. Packaging Specifications

1. SPECIFICATIONS

1.1 Features

<u>Item</u>	<u>Standard Value</u>
Display Resolution	1280 *3 (RGB) * 800 Dots
LCD Type	Full Viewing Angle , Normally Black, Transmissive type
Screen size(inch)	10.1 inch
Color configuration	R.G.B. Vertical Stripe
Weight	456g
Interface	LVDS
ROHS	THIS PRODUCT CONFORMS THE ROHS OF PTC Detail information please refer website: http://www.powertip.com.tw/news_detail.php?Key=1&cID=1

1.2 Mechanical Specifications

<u>Item</u>	<u>Standard Value</u>	<u>Unit</u>
Outline Dimension	229.8 (W) * 149.0 (L) * 14.75 (H)	mm

LCD panel

<u>Item</u>	<u>Standard Value</u>	<u>Unit</u>
View Area	217.96 (W) * 136.6 (L)	mm
Active Area	216.96 (W) * 135.6 (L)	mm

Note: For detailed information please refer to LCM drawing.

1.3 Absolute Maximum Ratings

Module

Item	Symbol	Condition	Min.	Max.	Unit	Remark
Logic Supply Voltage	V _{DD}	GND=0V	-0.3	+4.0	V	
Logic Input Signal Voltage	V _{signal}	GND=0V	-0.3	+4.0	V	
Power Supply for Backlight Unit	LED_V _{CC}	LED_GND=0V	-0.3	+18.0	V	-
Operating Temperature	T _{OP} (T _s)	Note 1	-20	+70	°C	
Storage Temperature	T _{ST} (T _a)	Note 2	-30	+80	°C	

The absolute maximum rating values of this product are not allowed to be exceeded at any time. Should a module be used with any of the absolute maximum ratings exceeded, the characteristics of the module may not be recovered, or in an extreme case, the module may be permanently destroyed.

Note 1: T_s is the temperature of panel's surface

Note 2: T_a is the ambient temperature of samples

1.4 DC Electrical Characteristics

GND = 0V, T_a = 25°C

Item	Symbol	Condition	Min.	Typ.	Max.	Unit
Logic Supply Voltage	V _{DD}	GND=0V	3.0	3.3	3.6	V
Logic Current	I _{DD}	V _{DD} = 3.3V	-	-	0.31	A
Logic Power Consumption	PV _{DD}		-	-	1	W
Power Supply for Backlight Unit	LED_V _{CC}	LED_GND=0V	9	12.0	18.0	V
Backlight Unit Power Consumption	PLED_V _{CC}	LED_V _{CC} = 12V	-	6	9	W
PWM Signal Voltage	V _{IH}	GND=0V	2	-	-	V
LED Enable Voltage	V _{IL}		-	-	0.8	
Input PWM Frequency	F _{PWM}		100	-	20k	Hz
PWM Duty Ratio	PWM		5	-	100	%

1.5 Optical Characteristics

VDD=3.3V, Ta=25°C

Item	Symbol		Condition	Min.	Typ.	Max.	unit	
Response time	Tr+Tf		Ta = 25°C θX, θY = 0°	-	25	50	ms	Note 2
Viewing angle	Top	θY+	CR ≥ 10	-	85	-	Deg.	Note 4
	Bottom	θY-		-	85	-		
	Left	θX-		-	85	-		
	Right	θX+		-	85	-		
Contrast ratio		CR		600	800	-		Note 3
Color of CIE Coordinate	White	X	Ta = 25°C θX, θY = 0°	0.25	0.30	0.35	-	Note1
		Y		0.29	0.34	0.39		
	Red	X		0.53	0.58	0.63		
		Y		0.30	0.35	0.40		
	Green	X		0.25	0.30	0.35		
		Y		0.53	0.58	0.63		
	Blue	X		0.08	0.13	0.18		
		Y		0.09	0.14	0.19		
Average Brightness Pattern=white display (With LCD)*2	IV		LED_Vcc =12.0V PWM="High" (Duty=100%)	650	800	-	cd/m ²	Note1
Uniformity (With LCD)*1	ΔB		LED_Vcc =12.0V PWM="High" (Duty=100%)	70	-	-	%	Note1

Note 1:

*1: $\Delta B = B(\min) / B(\max) * 100\%$

*2: Measurement Condition for Optical Characteristics:

a: Environment: $25^{\circ}\text{C} \pm 5^{\circ}\text{C}$ / $60 \pm 20\%$ R.H, no wind, dark room below 10 Lux at typical lamp current and typical operating frequency

b: Measurement Distance: 500 ± 50 mm, ($\theta = 0^{\circ}$)

c: Equipment: TOPCON BM-7 fast, (field 1°), after 10 minutes operation

d: The uncertainty of the C.I.E coordinate measurement ± 0.01 , Average Brightness $\pm 4\%$

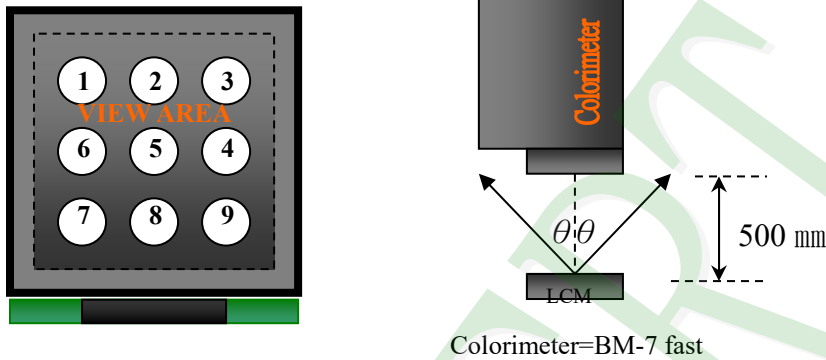

To be measured at the center area of panel with a viewing cone of 1° by Topcon luminance meter BM-7, after 10 minutes operation (module)

Note 2: Definition of response time:

The output signals of photo detector are measured when the input signals are changed from "black" to "white" (falling time) and from "white" to "black" (rising time), respectively. The response time is defined as the time interval between the 10% and 90% of Amplitudes.

Refer to figure as below:

Normally White



Normally Black

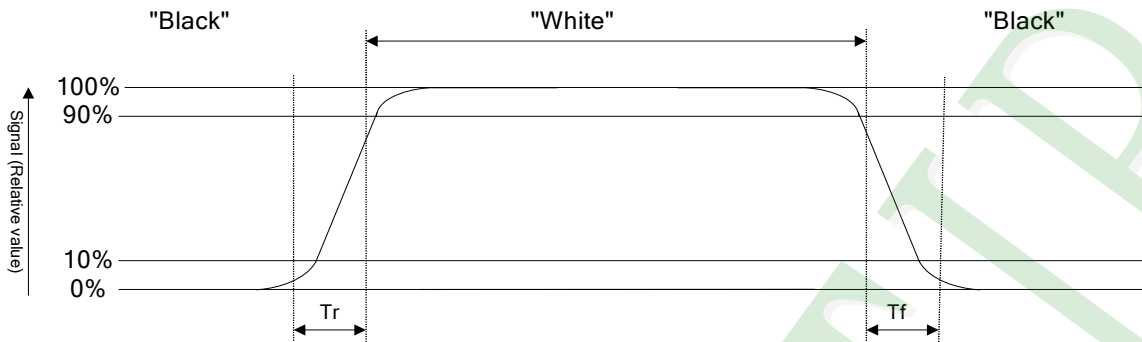

Note 3: Definition of contrast ratio:

Contrast ratio is calculated with the following formula

$$\text{Contrast ratio (CR)} = \frac{\text{Photo detector output when LCD is at "White" state}}{\text{Photo detector output when LCD is at "Black" state}}$$

Note 4: Definition of viewing angle:

Refer to figure as below:

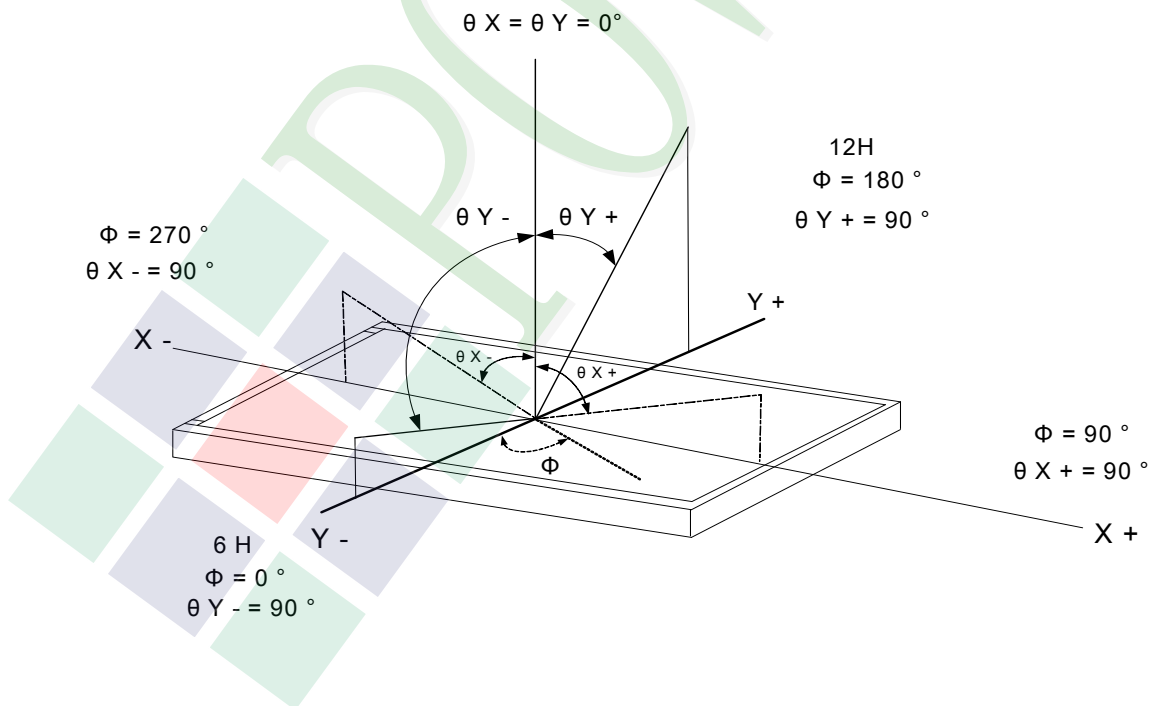

1.6 Backlight Unit Characteristics

Maximum Ratings

Item	Symbol	Min.	Max.	Unit	Remark
LED Forward Current	I_F	-	600	mA	
LED Reverse Voltage	V_R	-	13.2	V	
Power Dissipation	PD		20460	mW	

Electrical / Optical Characteristics

Item	Symbol	Min.	Typ.	Max.	Unit	Remark
LED Voltage	V_f	29.7	31.9	34.1	V	Note1
LED Current	I_f	-	180	-	mA	-
Average Brightness (without LCD) *1	I_V	17000	19000	28000	-	cd/m ²
CIE Color Coordinate (Without LCD)	X	0.25	0.28	0.335		
	Y	0.25	0.28	0.335		
LED life time	-	50,000	-	-	H _r	Note2

Note 1: The LED Supply Voltage is defined by the number of LED at $T_a=25^\circ\text{C}$ and $I_f=180\text{ mA}$

Note 2: The "LED life time" is defined as the module brightness decrease to 50% original brightness at $T_a=25^\circ\text{C}$ and $I_f=180\text{ mA}$. The LED life time could be decreased if operating I_L is larger than 180 mA

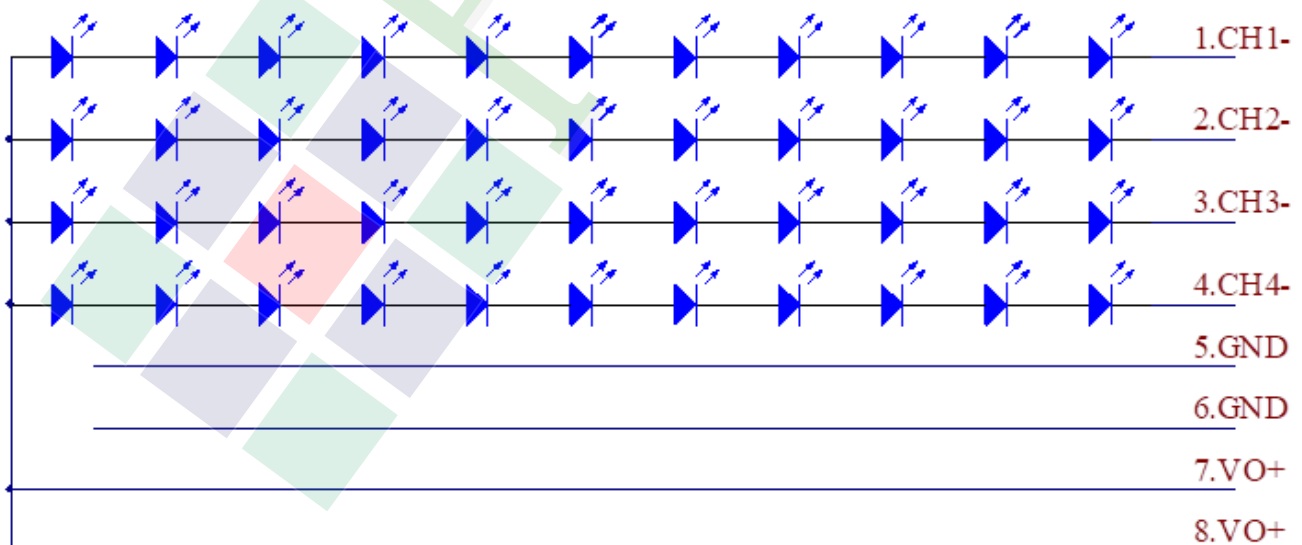

1.7 Touch Panel Unit Characteristics

Features

<u>Item</u>	<u>Standard Value</u>
Touch Panel Size	10.1"
Touch type	Projective capacitive touch panel
Input Method	Finger
Support Operation	5 Points touch
Firmware Ver.	-
Output Interface	I2C、USB
IC	ILI2132

Absolute Maximum Ratings

<u>Item</u>	<u>Symbol</u>	<u>Condition</u>	<u>Min.</u>	<u>Max.</u>	<u>unit</u>
Operating Temperature	T _{OP}	-	-20	+70	°C
Storage Temperature	T _{ST}	-	-30	+80	°C

I²C Address

<u>Bit7</u>	<u>Bit6</u>	<u>Bit5</u>	<u>Bit4</u>	<u>Bit3</u>	<u>Bit2</u>	<u>Bit1</u>	<u>Bit0</u>
1	0	0	0	0	0	1	R/W

R/W: 1 : Read
0 : write

DC Electrical Characteristics

<u>Item</u>	<u>Symbol</u>	<u>Condition</u>	<u>Min.</u>	<u>Typ.</u>	<u>Max.</u>	<u>unit</u>
Power Supply Voltage(I ² C)	VI2C	-	-	3.3	-	V
Power Supply Voltage(USB)	VUSB	-	-	5	-	V

Optical Characteristics

<u>Item</u>	<u>Standard Value</u>	<u>unit</u>
Total light transmittance	85% or more	-
Haze	3% or less	-

2. Module Structure

2.1 Counter Drawing

2.1.1 LCM Mechanical Diagram

* See Appendix

2.1.2 Block Diagram

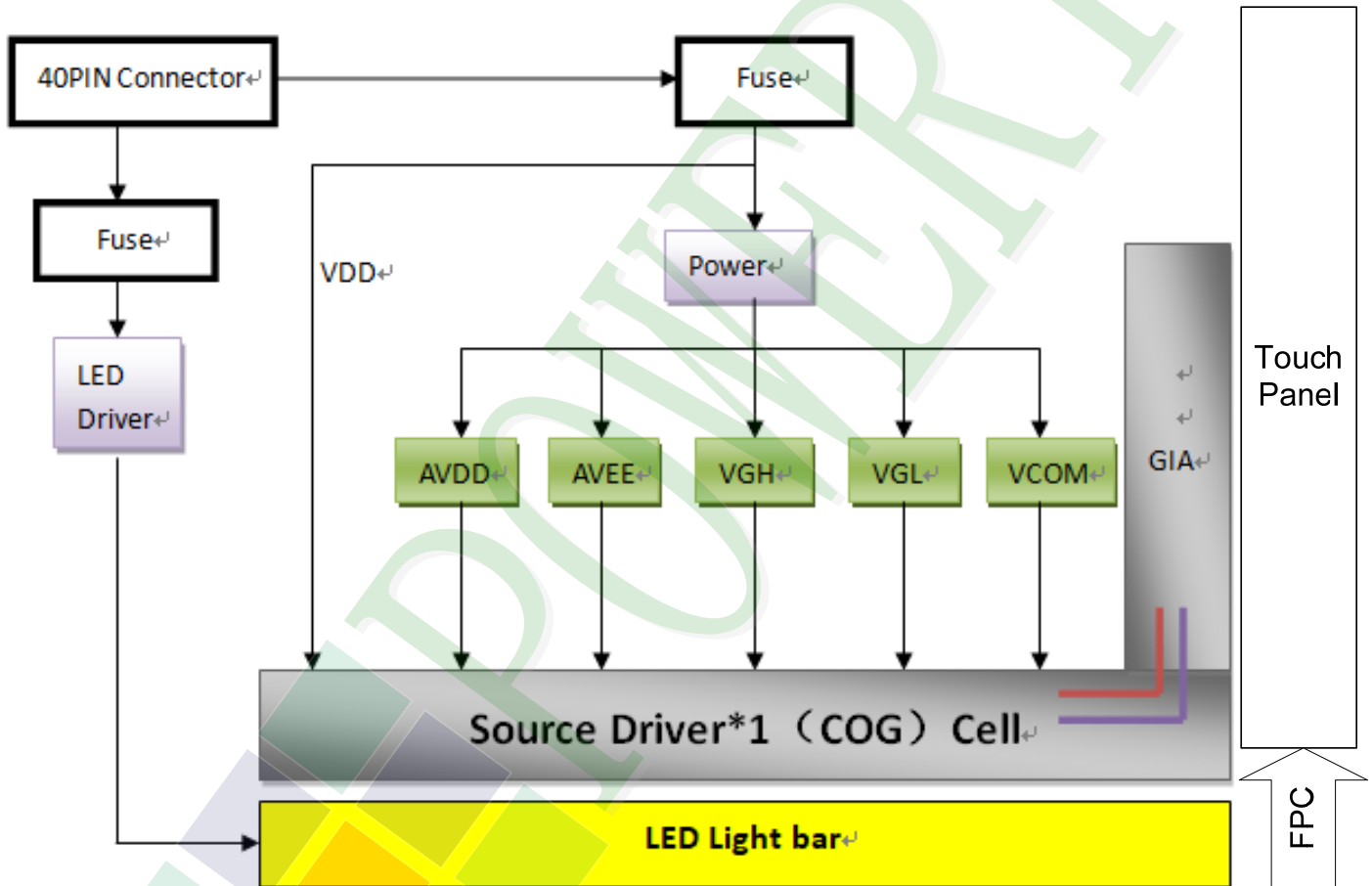

2.2 Interface Pin Description

TFT LCM Interface

Pin#	Name	Description
1	NC	No Connection.
2	VDD	Power Supply.
3	VDD	Power Supply.
4	NC	No Connection.
5	NC	No Connection.
6	NC	No Connection.
7	NC	No Connection.
8	LV0N	-LVDS Differential Data Input.
9	LV0P	+LVDS Differential Data Input.
10	GND	Power ground.
11	LV1N	-LVDS Differential Data Input.
12	LV1P	+LVDS Differential Data Input.
13	GND	Power ground.
14	LV2N	-LVDS Differential Data Input.
15	LV2P	+LVDS Differential Data Input.
16	GND	Power ground.
17	LVCLKN	-LVDS Differential Clock Input.
18	LVCLKP	+LVDS Differential Clock Input.
19	GND	Power ground.
20	LV3N	-LVDS Differential Data Input.
21	LV3P	+LVDS Differential Data Input.
22	GND	Power ground.
23	LED_GND	Ground for LED Driving.
24	LED_GND	Ground for LED Driving.
25	LED_GND	Ground for LED Driving.
26	NC	No Connection.
27	LED_PWM	PWM Input Signal for Backlight Diver.
28	LED_EN	Backlight Enable Pin.
29	NC	No Connection.

Pin#	Name	Description
30	NC	No Connection.
31	LED_VCC	Power Supply for Backlight Diver.
32	LED_VCC	Power Supply for Backlight Diver.
33	LED_VCC	Power Supply for Backlight Diver.
34	NC	No Connection.
35	BIST	Self Test Enable. When it is not used, please don't connect to GND, connecting to Normal High(3.3V) is recommended
36	NC	No Connection.
37	NC	No Connection.
38	NC	No Connection.
39	NC	No Connection.
40	NC	No Connection.

TP Connector Interface

CN1 I²C

Pin No.	Symbol	Function
1	GND	Ground.
2	I ² C_SDA	I ² C Data
3	I ² C_SCL	I ² C Clock
4	I ² C_INT	Active Low
5	I ² C_RST	Active low global reset signal input.
6	VI2C	Power Supply Voltage (3.3V)

CN2 USB

Pin No.	Symbol	Function
1	VUSB	Power Supply Voltage (5V)
2	USB_DN	Negative Data
3	USB_DP	Positive Data
4	GND	Ground
5	GND	Ground

2.3 Timing Characteristics

2.3.1 Signal Electrical Characteristics For LVDS Receiver

The built-in LVDS receiver is compatible with (ANSI/TIA/TIA-644) standard.

Parameter	Symbol	Min.	Typ.	Max.	Unit	Conditions
Differential Input High Threshold	V _{th}	-	-	100	mV	V _{CM} =+1.2V
Differential Input Low Threshold	V _{tl}	-100	-	-	mV	V _{CM} =+1.2V
Input voltage range(singled-end)	RXVIN	0.7		1.7	V	-
Magnitude Differential Input Voltage	V _{ID}	200	-	600	mV	-
Common Mode Voltage	V _{CM}	1	1.2	1.4	V	V _{ID} =0.2

Note (1) Input signals shall be low or Hi-resistance state when VDD is off.

Note (2) All electrical characteristics for LVDS signal are defined and shall be measured at the interface connector of LCD.

Single-end Signals

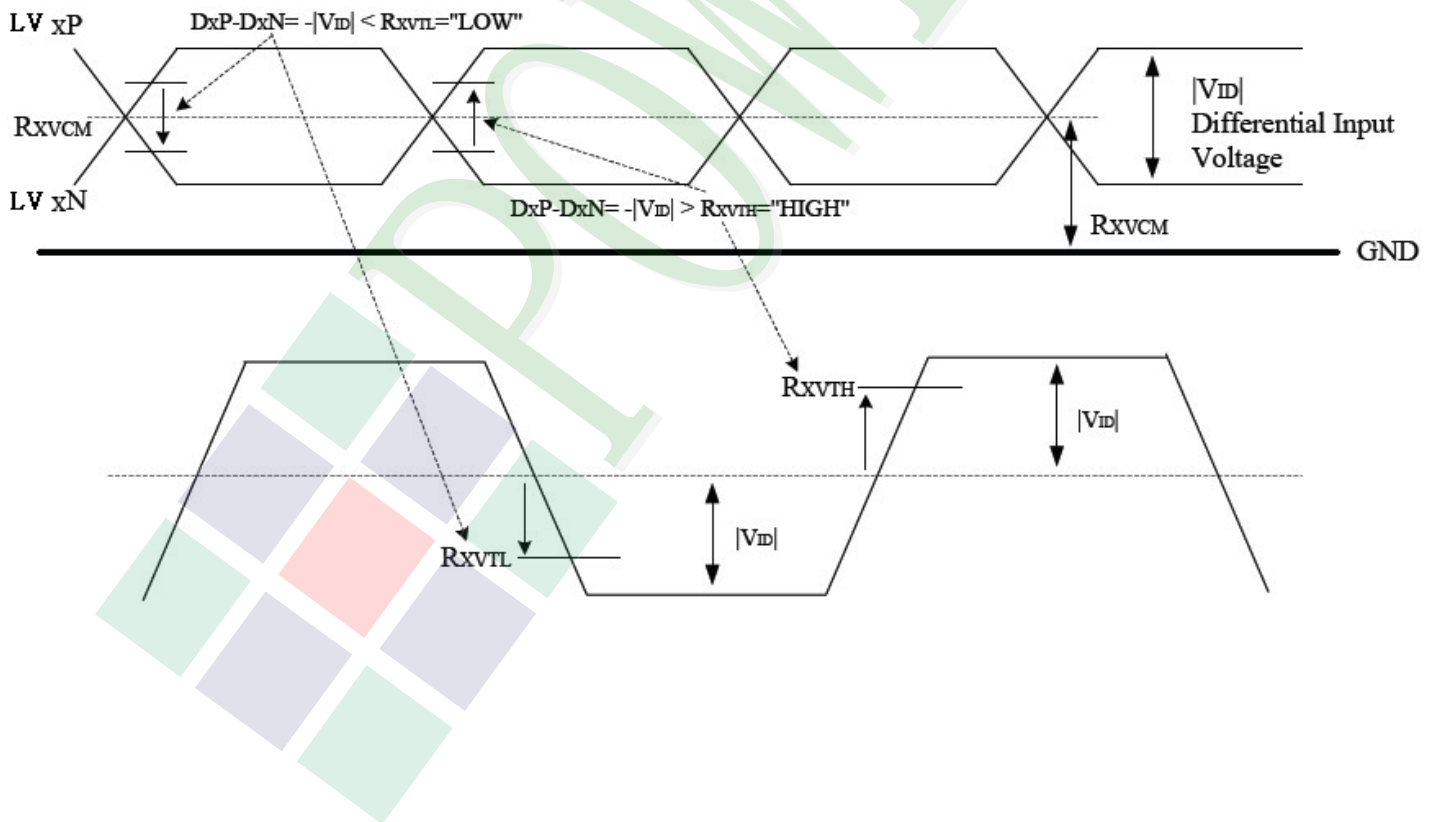

2.3.2 Input Timing

Parameter	Symbol	Min.	Typ.	Max.	Unit
LVDS Clock Frequency	Fclk	70.0	72.4	76.6	MHz
H Total Time	HT	1410	1440	1470	Clocks
H Active Time	HA	1280			
V Total Time	VT	828	838	868	Lines
V Active Time	VA	800			
Frame Rate	FV	-	60	-	Hz

Note1: $HT * VT * \text{Frame Frequency} \leq (76.6) \text{ MHz}$

Note2: All reliabilities are specified for timing specification based on refresh rate of 60Hz.

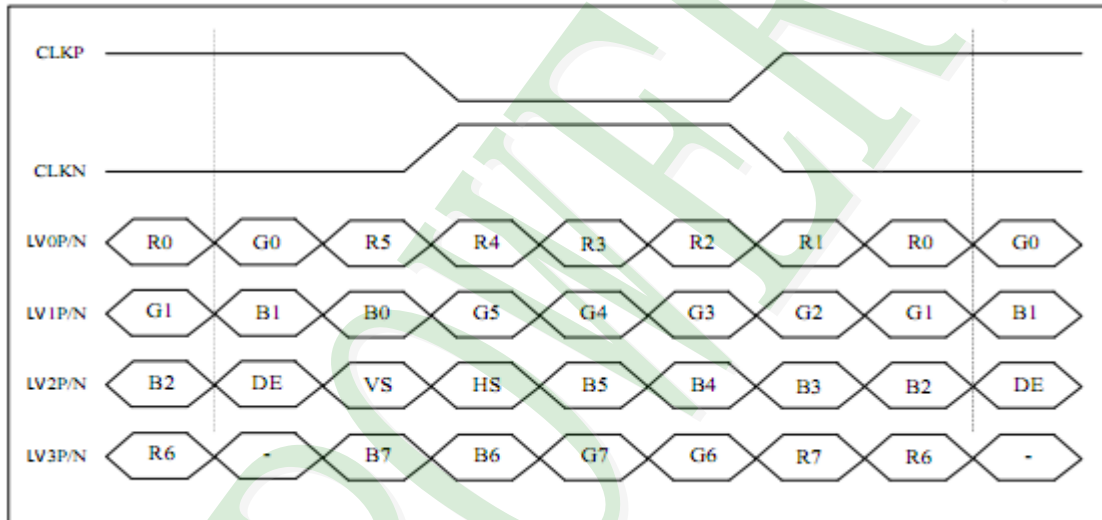

2.3.4 Power ON/OFF Sequence

- Interface signals are also shown in the chart. Signals from any system shall be Hi-resistance state or low level when VDD voltage is off.
- Please set timing according to the following figures, otherwise it may cause image sticking

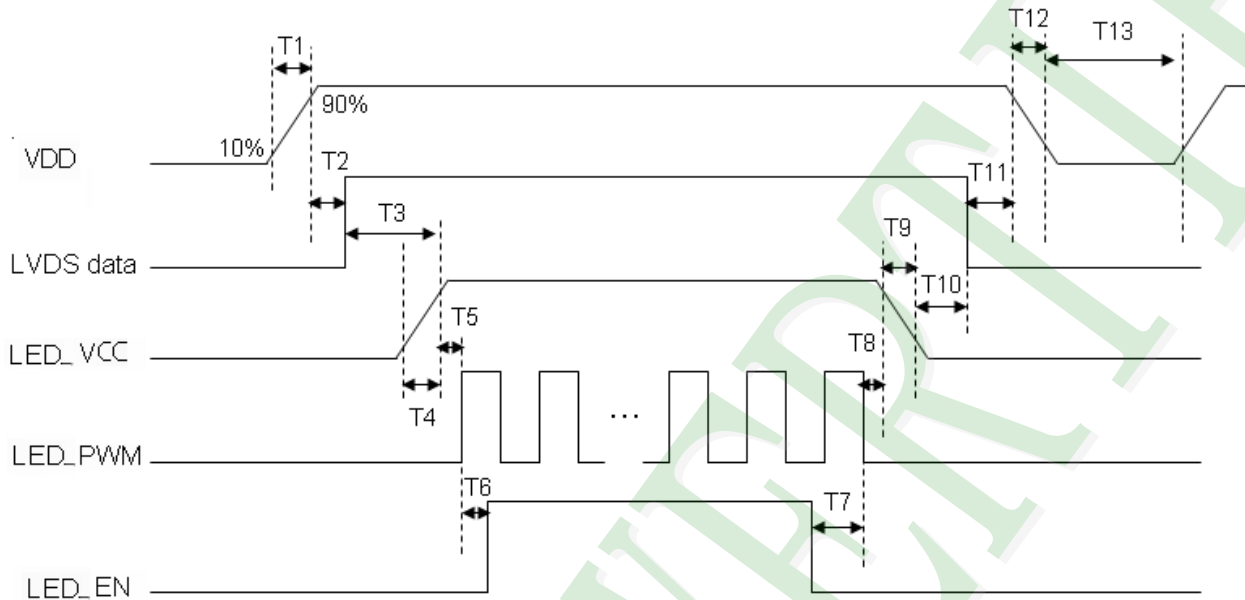

Parameter	Symbol	Unit	Min	Typ.	Max
VDD Rise Time (10% to 90%)	T1	ms	0.5	--	10
VDD Good to Signal Valid	T2	ms	30	--	90
Signal Valid to Backlight On	T3	ms	200	--	--
Backlight Power On Time	T4	ms	0.5	--	--
Backlight LED_VCC Good to System PWM On	T5	ms	10	--	--
System PWM On to Backlight LED_EN On	T6	ms	10	--	--
Backlight LED_EN Off to System PWM Off	T7	ms	0	--	--
System PWM Off to B/L Power Disable	T8	ms	10	--	--
Backlight Power Off Time	T9	ms	0.5	10	30
Backlight Off to Signal Disable	T10	ms	200	--	--
Signal Disable to Power Down	T11	ms	0	--	50
VDD Fall Time	T12	ms	0.5	10	30
Power Off	T13	ms	500	--	--

3. Quality Assurance System

3.1 Quality Assurance Flow Chart

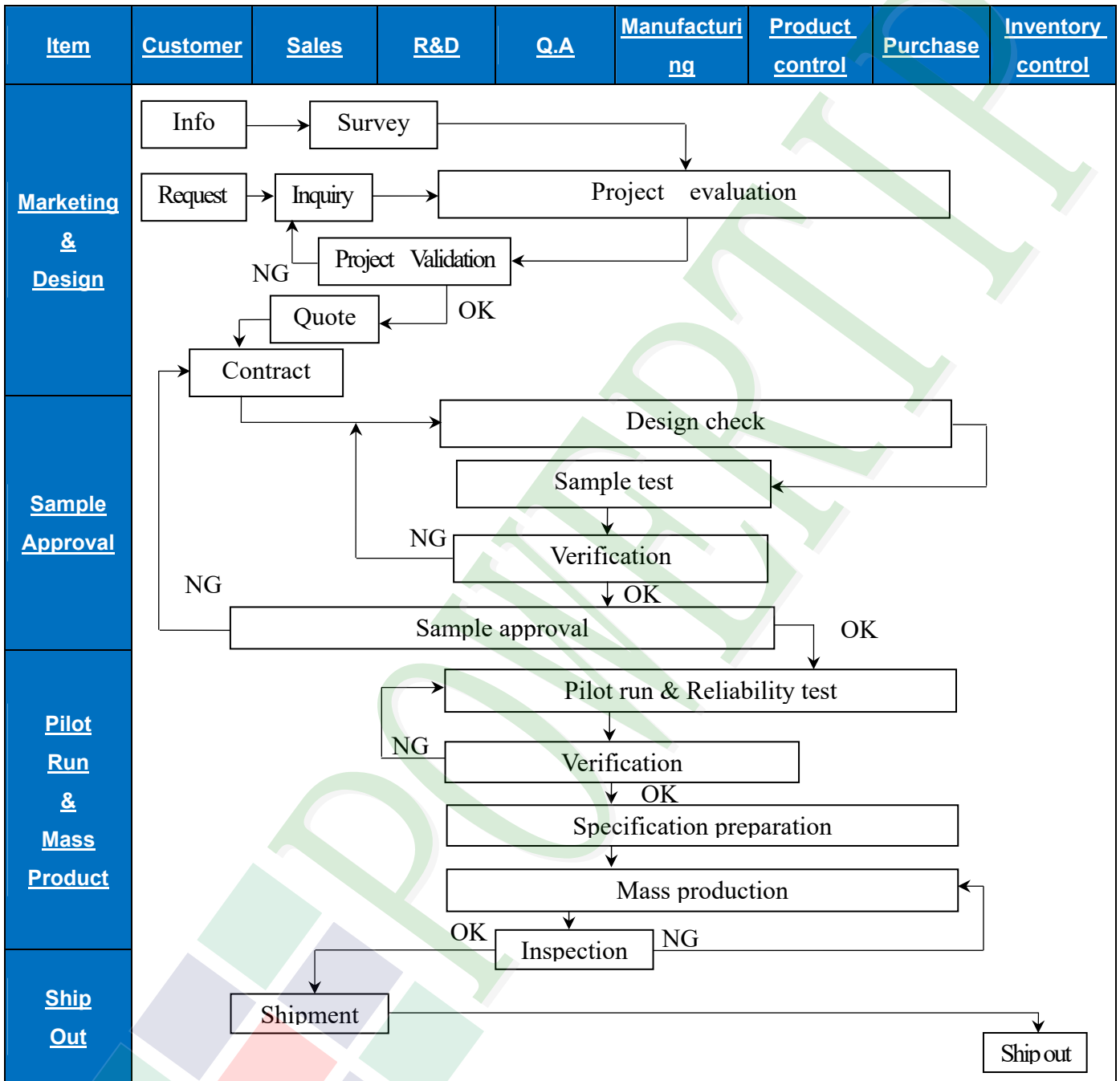

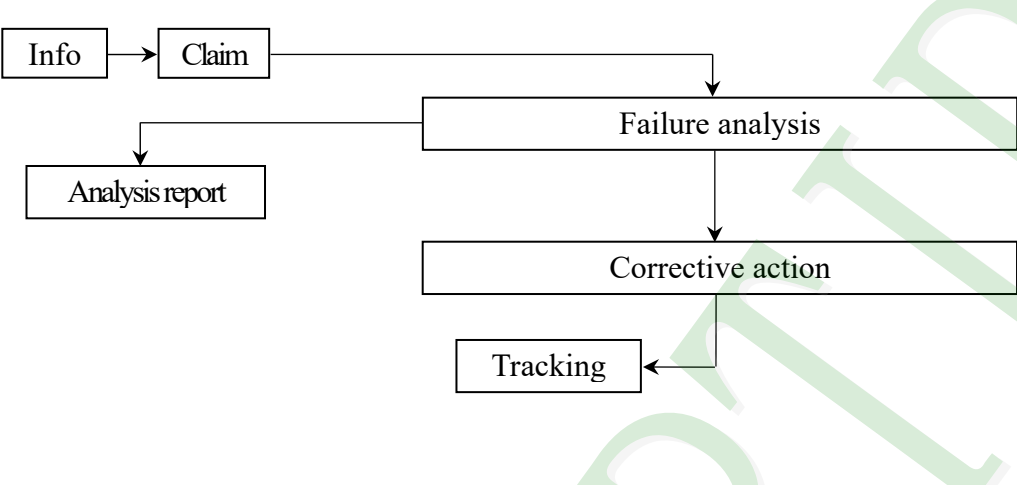
Item	Customer	Sales	R&D	Q.A	Manufacturing	Product control	Purchase	Inventory control
Sales Service	 <pre> graph TD Info[Info] --> Claim[Claim] Claim --> Failure[Failure analysis] Failure --> Report[Analysis report] Failure --> Action[Corrective action] Action --> Tracking[Tracking] </pre>							
Q.A Activity	<ol style="list-style-type: none"> 1. ISO 9001 Maintenance Activities 2. Process improvement proposal 3. Equipment calibration 4. Education And Training Activities 5. Standardization Management 							

3.2 Inspection Specification

- ◆Scope: The document shall be applied to TFT-LCD Module for 3.5"-15" (Ver.B01).
- ◆Inspection Standard: MIL-STD-105E Table Normal Inspection Single Sampling Level II.
- ◆Equipment: Gauge, MIL-STD, Powertip Tester, Sample
- ◆Defect Level: Major Defect AQL: 0.4; Minor Defect AQL: 1.5
- ◆OUT Going Defect Level: Sampling
- ◆Standard of the product appearance test:

a. Manner of appearance test:

- (1). The test best be under 20W×2 fluorescent light(about 300lux ~500lux) and distance of view must be at 30~40 cm.
- (2). The test direction is base on about around 45° of vertical line.

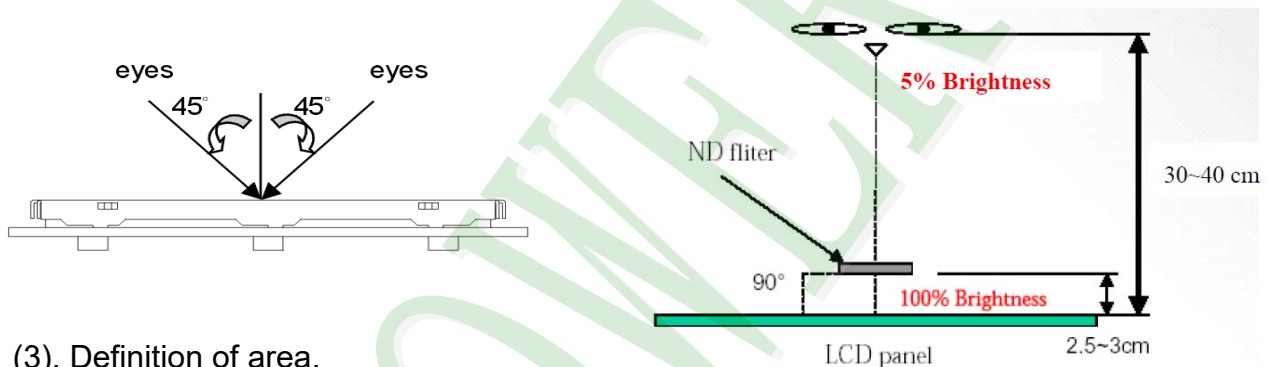

(3). Definition of area.

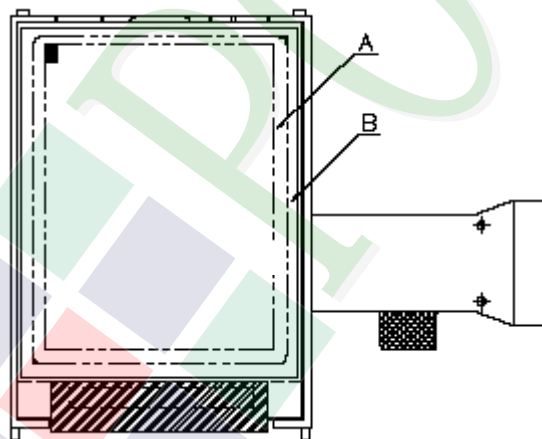

A area: viewing area

B area: Outside of viewing area

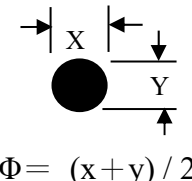
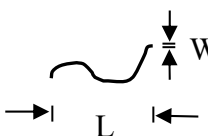

(4). Standard of inspection : (Unit : mm)

NO	Item	Criterion	Level													
01	Product condition	1.1 The part number is inconsistent with work order of production.	Major													
		1.2 Mixed product types.	Major													
		1.3 Assembled in inverse direction.	Major													
02	Quantity	2.1 The quantity is inconsistent with work order of production.	Major													
03	Outline dimension	3.1 Product dimension and structure must conform to structure diagram.	Major													
04	Electrical Testing	4.1 Missing line character and icon.	Major													
		4.2 No function or no display.	Major													
		4.3 Display malfunction.	Major													
		4.4 LCD viewing angle defect.	Major													
		4.5 Current consumption exceeds product specifications.	Major													
		4.6 Mura cannot be seen through 5% ND filter at 50% Gray, should be judged by the viewing angle of 90 degree.	Minor													
05	Dot defect (Bright dot, Dark dot) On -display	<table border="1"> <thead> <tr> <th></th> <th>Item</th> <th>Acceptance (Q'ty)</th> </tr> </thead> <tbody> <tr> <td rowspan="4">Dot Defect</td> <td>Bright Dot</td> <td>≤ 4</td> </tr> <tr> <td>Dark Dot</td> <td>≤ 5</td> </tr> <tr> <td>Joint Dot</td> <td>≤ 3</td> </tr> <tr> <td>Total</td> <td>≤ 7</td> </tr> </tbody> </table>		Item	Acceptance (Q'ty)	Dot Defect	Bright Dot	≤ 4	Dark Dot	≤ 5	Joint Dot	≤ 3	Total	≤ 7	5.1 Inspection pattern: full white, full black, Red, Green and blue screens. 5.2 It is defined as dot defect if defect area $> 1/2$ dot. 5.3 The distance between two dot defect ≥ 5 mm. 5.4 Bright dot : Dots appear bright and unchanged in visible with 5% ND filter is defined. 5.5 Tiny bright dot: bright dot area $\leq 1/2$ dot. a. Dots appear bright and unchanged in visible with 5% ND filter is defined defect and is judged in accordance with 6.1 b. Dots invisible with 5% ND Filter is Ignored	Minor
			Item	Acceptance (Q'ty)												
		Dot Defect	Bright Dot	≤ 4												
			Dark Dot	≤ 5												
			Joint Dot	≤ 3												
Total	≤ 7															

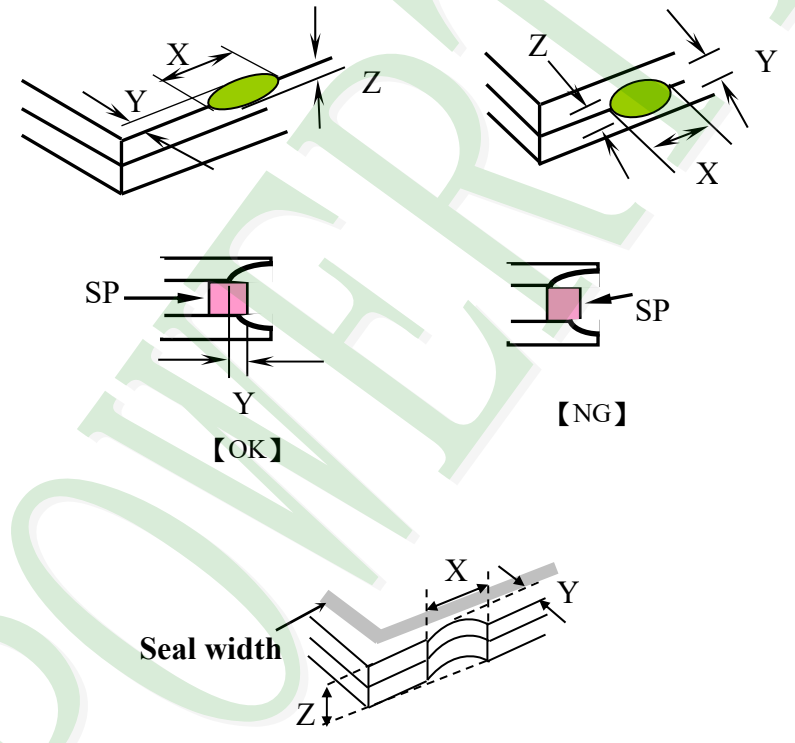
NO	Item	Criterion	Level																																			
06	Black or white Dot, scratch, contamination Round type  $\Phi = (x + y) / 2$ Line type 	6.1 Round type (Non-display or display): <table border="1"> <thead> <tr> <th rowspan="2">Dimension (diameter: Φ)</th> <th colspan="2">Acceptance (Q'ty)</th> </tr> <tr> <th>A area</th> <th>B area</th> </tr> </thead> <tbody> <tr> <td>$\Phi \leq 0.25$</td> <td>Ignore</td> <td rowspan="4">Ignore</td> </tr> <tr> <td>$0.25 < \Phi \leq 0.50$</td> <td>5</td> </tr> <tr> <td>$\Phi > 0.50$</td> <td>0</td> </tr> <tr> <td>Total</td> <td>5</td> </tr> </tbody> </table>	Dimension (diameter: Φ)	Acceptance (Q'ty)		A area	B area	$\Phi \leq 0.25$	Ignore	Ignore	$0.25 < \Phi \leq 0.50$	5	$\Phi > 0.50$	0	Total	5	Minor																					
		Dimension (diameter: Φ)		Acceptance (Q'ty)																																		
A area	B area																																					
$\Phi \leq 0.25$	Ignore	Ignore																																				
$0.25 < \Phi \leq 0.50$	5																																					
$\Phi > 0.50$	0																																					
Total	5																																					
6.2 Line type(Non-display or display): <table border="1"> <thead> <tr> <th rowspan="2">module size</th> <th rowspan="2">Length (L)</th> <th rowspan="2">Width (W)</th> <th colspan="2">Acceptance (Q'ty)</th> </tr> <tr> <th>A area</th> <th>B area</th> </tr> </thead> <tbody> <tr> <td rowspan="5">3.5" to less 9"</td> <td>---</td> <td>$W \leq 0.03$</td> <td>Ignore</td> <td rowspan="5">Ignore</td> </tr> <tr> <td>$L \leq 10.0$</td> <td>$0.03 < W \leq 0.05$</td> <td>4</td> </tr> <tr> <td>$L \leq 5.0$</td> <td>$0.05 < W \leq 0.10$</td> <td>2</td> </tr> <tr> <td>---</td> <td>$W > 0.10$</td> <td>As round type</td> </tr> <tr> <td colspan="2">Total</td> <td>5</td> </tr> <tr> <td rowspan="5">9" to 15"</td> <td>---</td> <td>$W \leq 0.05$</td> <td>Ignore</td> <td rowspan="5">Ignore</td> </tr> <tr> <td>$L \leq 10.0$</td> <td>$0.05 < W \leq 0.10$</td> <td>5</td> </tr> <tr> <td>---</td> <td>$W > 0.10$</td> <td>As round type</td> </tr> <tr> <td colspan="2">Total</td> <td>5</td> </tr> </tbody> </table>	module size	Length (L)	Width (W)	Acceptance (Q'ty)		A area	B area	3.5" to less 9"	---	$W \leq 0.03$	Ignore	Ignore	$L \leq 10.0$	$0.03 < W \leq 0.05$	4	$L \leq 5.0$	$0.05 < W \leq 0.10$	2	---	$W > 0.10$	As round type	Total		5	9" to 15"	---	$W \leq 0.05$	Ignore	Ignore	$L \leq 10.0$	$0.05 < W \leq 0.10$	5	---	$W > 0.10$	As round type	Total		5
module size				Length (L)	Width (W)	Acceptance (Q'ty)																																
	A area	B area																																				
3.5" to less 9"	---	$W \leq 0.03$	Ignore	Ignore																																		
	$L \leq 10.0$	$0.03 < W \leq 0.05$	4																																			
	$L \leq 5.0$	$0.05 < W \leq 0.10$	2																																			
	---	$W > 0.10$	As round type																																			
	Total		5																																			
9" to 15"	---	$W \leq 0.05$	Ignore	Ignore																																		
	$L \leq 10.0$	$0.05 < W \leq 0.10$	5																																			
	---	$W > 0.10$	As round type																																			
	Total		5																																			
	07	Polarizer Bubble	<table border="1"> <thead> <tr> <th rowspan="2">Dimension (diameter: Φ)</th> <th colspan="2">Acceptance (Q'ty)</th> </tr> <tr> <th>A area</th> <th>B area</th> </tr> </thead> <tbody> <tr> <td>$\Phi \leq 0.25$</td> <td>Ignore</td> <td rowspan="5">Ignore</td> </tr> <tr> <td>$0.25 < \Phi \leq 0.50$</td> <td>4</td> </tr> <tr> <td>$0.50 < \Phi \leq 0.80$</td> <td>1</td> </tr> <tr> <td>$\Phi > 0.80$</td> <td>0</td> </tr> <tr> <td>Total</td> <td>5</td> </tr> </tbody> </table>		Dimension (diameter: Φ)	Acceptance (Q'ty)		A area	B area	$\Phi \leq 0.25$	Ignore	Ignore	$0.25 < \Phi \leq 0.50$	4	$0.50 < \Phi \leq 0.80$	1	$\Phi > 0.80$	0	Total	5	Minor																	
Dimension (diameter: Φ)	Acceptance (Q'ty)																																					
	A area	B area																																				
$\Phi \leq 0.25$	Ignore	Ignore																																				
$0.25 < \Phi \leq 0.50$	4																																					
$0.50 < \Phi \leq 0.80$	1																																					
$\Phi > 0.80$	0																																					
Total	5																																					

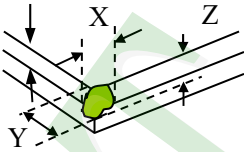
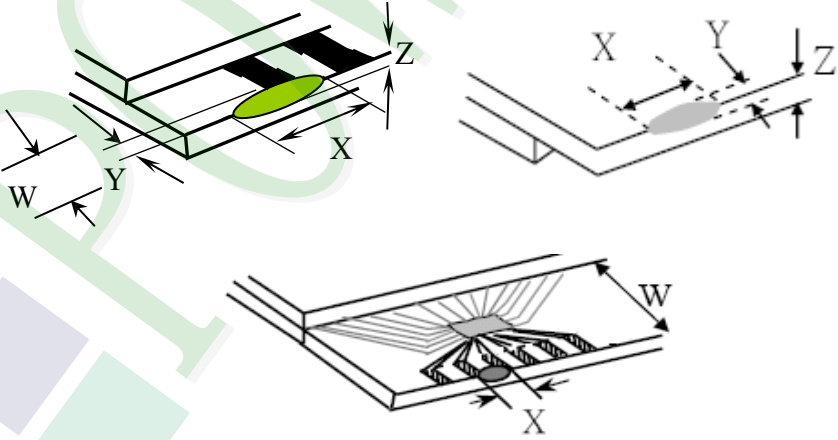
NO	Item	Criterion	Level						
08	The crack of glass	Symbols : X: The length of crack Y: The width of crack. Z: The thickness of crack W: terminal length T: The thickness of glass a : LCD side length	Minor						
		8.1 General glass chip: 8.1.1 Chip on panel surface and crack between panels:  <table border="1" data-bbox="539 1505 1353 1796"> <thead> <tr> <th>X</th> <th>Y</th> <th>Z</th> </tr> </thead> <tbody> <tr> <td>$\leq \leq a$</td> <td>Crack can't enter viewing area</td> <td>$\leq 1/2 t$</td> </tr> <tr> <td>$\leq a$</td> <td>Crack can't exceed the half of SP width.</td> <td>$1/2 t < Z \leq 2 t$</td> </tr> </tbody> </table>		X	Y	Z	$\leq \leq a$	Crack can't enter viewing area	$\leq 1/2 t$
X	Y	Z							
$\leq \leq a$	Crack can't enter viewing area	$\leq 1/2 t$							
$\leq a$	Crack can't exceed the half of SP width.	$1/2 t < Z \leq 2 t$							

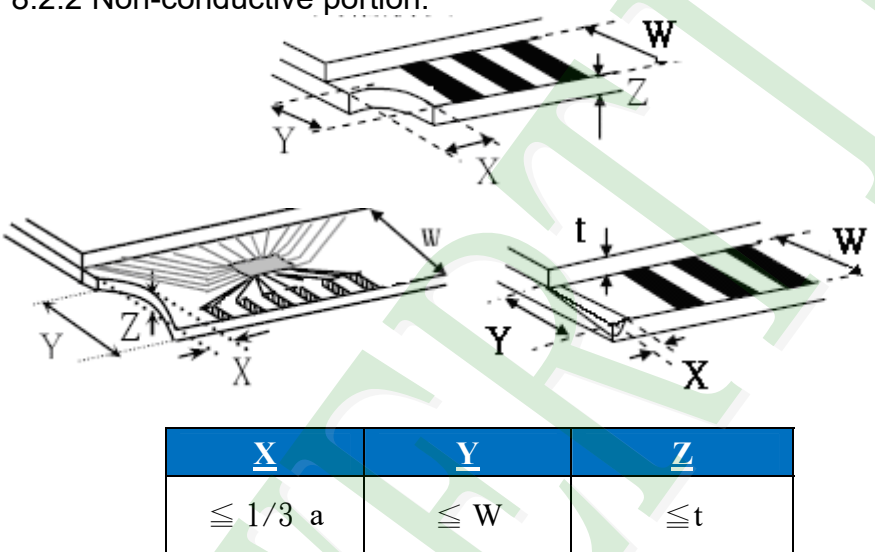
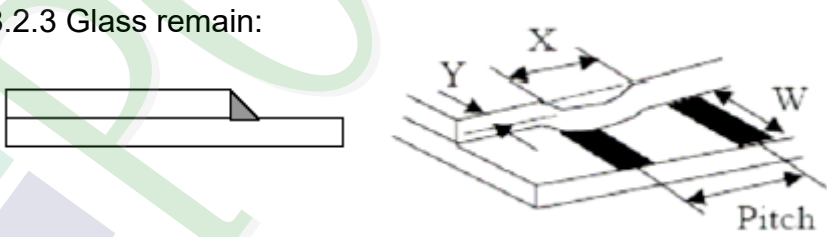
NO	Item	Criterion	Level										
08	The crack of glass	<p>Symbols :</p> <p>X: The length of crack Z: The thickness of crack t: The thickness of glass</p> <p>Y: The width of crack. W: terminal length a: LCD side length</p> <hr/> <p>8.1.2 Corner crack:</p>  <table border="1" data-bbox="520 763 1337 1055"> <thead> <tr> <th><u>X</u></th> <th><u>Y</u></th> <th><u>Z</u></th> </tr> </thead> <tbody> <tr> <td>$\leq 1/5 a$</td> <td>Crack can't enter viewing area</td> <td>$Z \leq 1/2 t$</td> </tr> <tr> <td>$\leq 1/5 a$</td> <td>Crack can't exceed the half of SP width.</td> <td>$1/2 t < Z \leq 2 t$</td> </tr> </tbody> </table>	<u>X</u>	<u>Y</u>	<u>Z</u>	$\leq 1/5 a$	Crack can't enter viewing area	$Z \leq 1/2 t$	$\leq 1/5 a$	Crack can't exceed the half of SP width.	$1/2 t < Z \leq 2 t$		
		<u>X</u>	<u>Y</u>	<u>Z</u>									
$\leq 1/5 a$	Crack can't enter viewing area	$Z \leq 1/2 t$											
$\leq 1/5 a$	Crack can't exceed the half of SP width.	$1/2 t < Z \leq 2 t$											
<p>8.2 Protrusion over terminal:</p> <p>8.2.1 Chip on electrode pad:</p>  <table border="1" data-bbox="560 1693 1347 1868"> <thead> <tr> <th></th> <th><u>X</u></th> <th><u>Y</u></th> <th><u>Z</u></th> </tr> </thead> <tbody> <tr> <td><u>Front</u></td> <td>$\leq a$</td> <td>$\leq 1/2 W$</td> <td>$\leq t$</td> </tr> <tr> <td><u>Back</u></td> <td>$\leq a$</td> <td>$\leq W$</td> <td>$\leq 1/2 t$</td> </tr> </tbody> </table>		<u>X</u>	<u>Y</u>	<u>Z</u>	<u>Front</u>	$\leq a$	$\leq 1/2 W$	$\leq t$	<u>Back</u>	$\leq a$	$\leq W$	$\leq 1/2 t$	Minor
	<u>X</u>	<u>Y</u>	<u>Z</u>										
<u>Front</u>	$\leq a$	$\leq 1/2 W$	$\leq t$										
<u>Back</u>	$\leq a$	$\leq W$	$\leq 1/2 t$										

NO	Item	Criterion	Level												
08	The crack of glass	<p>Symbols:</p> <p>X: The length of crack Y: The width of crack. Z: The thickness of crack W: terminal length t: The thickness of glass a: LCD side length</p> <p>8.2.2 Non-conductive portion:</p>  <table border="1" data-bbox="625 963 1257 1086"> <thead> <tr> <th><u>X</u></th> <th><u>Y</u></th> <th><u>Z</u></th> </tr> </thead> <tbody> <tr> <td>$\leq 1/3 a$</td> <td>$\leq W$</td> <td>$\leq t$</td> </tr> </tbody> </table> <p>If the chipped area touches the ITO terminal, over 2/3 of the ITO must remain and be inspected according to electrode terminal specifications.</p> <p>8.2.3 Glass remain:</p>  <table border="1" data-bbox="545 1585 1241 1709"> <thead> <tr> <th><u>X</u></th> <th><u>Y</u></th> <th><u>Z</u></th> </tr> </thead> <tbody> <tr> <td>$\leq a$</td> <td>$\leq 1/3 W$</td> <td>$\leq t$</td> </tr> </tbody> </table> <p>8.2.4 Cracking:</p>  <p>Not Allowed</p>	<u>X</u>	<u>Y</u>	<u>Z</u>	$\leq 1/3 a$	$\leq W$	$\leq t$	<u>X</u>	<u>Y</u>	<u>Z</u>	$\leq a$	$\leq 1/3 W$	$\leq t$	Minor
<u>X</u>	<u>Y</u>	<u>Z</u>													
$\leq 1/3 a$	$\leq W$	$\leq t$													
<u>X</u>	<u>Y</u>	<u>Z</u>													
$\leq a$	$\leq 1/3 W$	$\leq t$													

NO	Item	Criterion	Level
09	Backlight elements	9.1 Backlight can't work normally.	Major
		9.2 Backlight doesn't light or color is wrong.	Major
		9.3 Illumination source flickers when lit.	Major
10	General appearance	10.1 Pin type, quantity, dimension must match type in structure diagram.	Major
		10.2 No short circuits in components on PCB or FPC.	Major
		10.3 Parts on PCB or FPC must be: no wrong parts, missing parts or excess parts.	Major
		10.4 Product packaging must the same as specified on packaging specification sheet.	Minor
		10.5 The folding and peeled off in polarizer are not acceptable.	Minor
		10.6 The PCB or FPC between B/L assembled distance (PCB or FPC) is ≤ 1.5 mm.	Minor

5. PRECAUTION RELATING PRODUCT HANDLING

5.1 SAFETY

- 5.1.1 If the LCD panel breaks, be careful not to get the liquid crystal to touch your skin.
- 5.1.2 If the liquid crystal touches your skin or clothes, please wash it off immediately by using soap and water.

5.2 HANDLING

- 5.2.1 Avoid any strong mechanical shock which can break the glass.
- 5.2.2 Avoid static electricity which can damage the CMOS LSI—When working with the module, be sure to ground your body and any electrical equipment you may be using.
- 5.2.3 Do not remove the panel or frame from the module.
- 5.2.4 The polarizing plate of the display is very fragile. So, please handle it very carefully, do not touch, push or rub the exposed polarizing with anything harder than an HB pencil lead (glass, tweezers, etc.)
- 5.2.5 Do not wipe the polarizing plate with a dry cloth, as it may easily scratch the surface of plate.
- 5.2.6 Do not touch the display area with bare hands, this will stain the display area.
- 5.2.7 Do not use ketonics solvent & aromatic solvent. Use with a soft cloth soaked with a cleaning naphtha solvent.
- 5.2.8 To control temperature and time of soldering is $320 \pm 10^{\circ}\text{C}$ and 3-5 sec.
- 5.2.9 To avoid liquid (include organic solvent) stained on LCM
- 5.2.10 Caution!(LCM products with Capacitive Touch Panel)
Strong EMI-sources such as switch-mode power supplies (SMPS) can lead to touch malfunction (e.g. ghost-touches).
Therefore, the touch needs to be thoroughly tested inside the target application.
- 5.2.11 CAUTION: Continuously displaying same static image will result in high possibility of image sticking/image burn-in effect due to TFT panel characteristic.
- 5.2.12 Double-sided tape designed to be attach with the customer's mechanical device, please follow up the rules and regulations published by the original manufacturer of double-sided tape for the attachment operation.

5.3 STORAGE

- 5.3.1 Store the panel or module in a dark place where the temperature is $25^{\circ}\text{C} \pm 5^{\circ}\text{C}$ and the humidity is below 65% RH.
- 5.3.2 Do not place the module near organics solvents or corrosive gases.
- 5.3.3 Do not crush, shake, or jolt the module.

5.4 TERMS OF WARRANTY

- 5.4.1 Applicable warrant period The period is within thirteen months since the date of shipping out under normal using and storage conditions.
- 5.4.2 Unaccepted responsibility
This product has been manufactured to your company's specification as a part for use in your company's general electronic products. It is guaranteed to perform according to delivery specifications. For any other use apart from general electronic equipment, we cannot take responsibility if the product is used in nuclear power control equipment, aerospace equipment, fire and security systems or any other applications in which there is a direct risk to human life and where extremely high levels of reliability are required.

Approve	Check	Contact
Bright	Tina	Clare

1. 包裝材料規格表(Packaging Material) : (per carton)

No.	Item	Model	Dimensions (mm)	1Pcs Weight	Quantity	Total Weight
1	成品 (LCM)	PH128800T006-ZHC01	229.8 X 149.0	0.456	340	155.04
2	氣泡袋(1)Bubble Bag	BAG0000000015	300 X 180	0.01	340	3.4
3	A10隔板(2)A10 Partition	BX00000000119	340 X 174 X 7	0.031	360	11.16
4	B10隔板(3)B10 Partition	BX00000000118	500 X 174 X 7	0.037	40	1.48
5	舒美墊(4)EPE	FOAM000000244	500 X 340 X 20	0.036	40	1.44
6	外箱C6(5)Carton	BX00000000120	514 X 354 X 228	0.75	20	15.0
7	舒美墊(6)EPE	FOAM000000245	170 X 130 X 15	0.01	80	0.8
8	舒美墊(7)EPE	FOAM000000246	170 X 23 X 15	0.001	1100	1.1
9	棧板(8)PALLET	OTPALLET00007	1200 X 800 X 140	5.5	1	5.5

2. 一整箱總重量 (Total LCD Weight in carton) : 194.92 Kg±10%

3. 單箱數量規格表(Packaging Specifications and Quantity) :

(1)Quantity Of Spacer : A10隔板 X 18 , B10隔板 X 2

(2)Total LCM quantity in carton : quantity per box 17 x no of boxes 1 = 17

(3)Total LCM quantity in pallet : quantity per carton 17 x no. of cartons 20 = 340

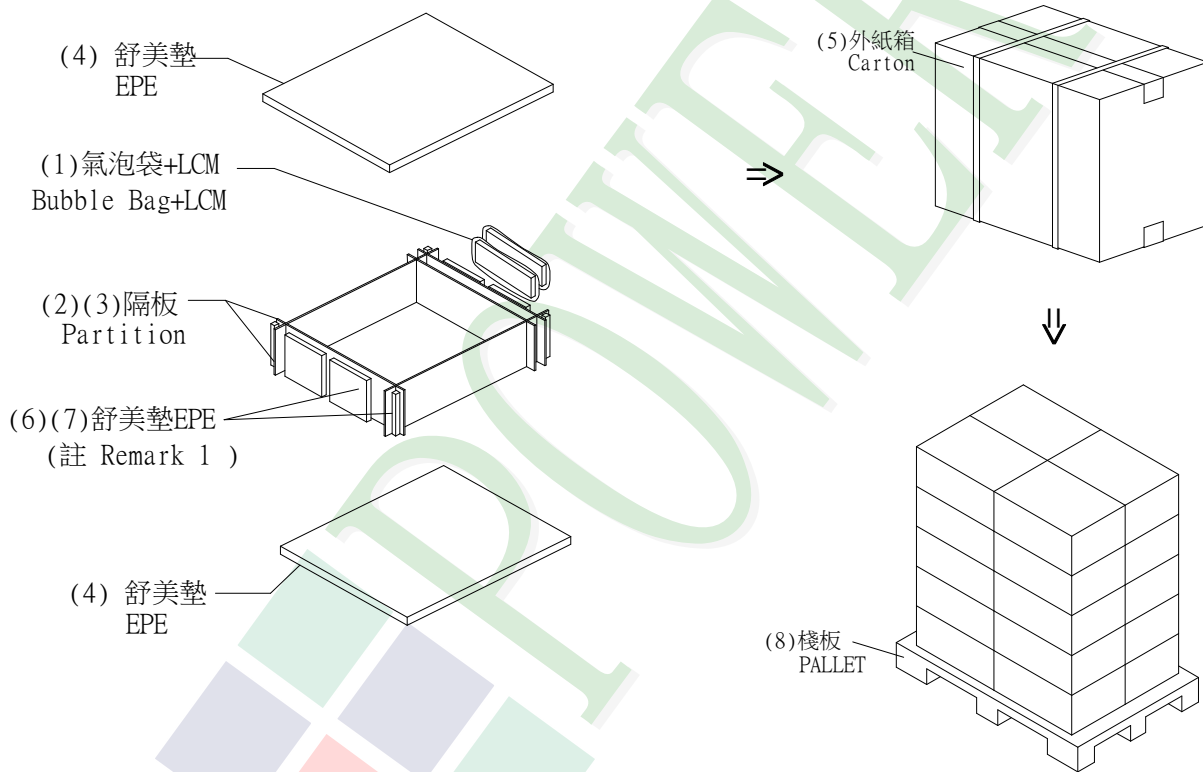

特 記 事 項 (REMARK)

1. LCM排放示意圖(前後間隔不放置):
1. LCM placed as figure showing:
(First and last slot should be empty)

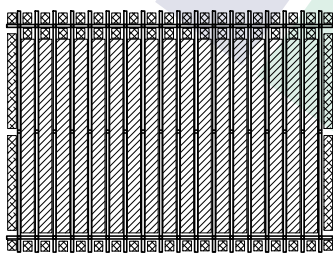

▨ 模組(LCM) X lpcs.

2. 外箱剩餘空間以緩衝材填補
The remaining space of the carton is filled with buffer material

3. 棧板外箱擺放方式: 一層擺放4箱外箱, 共5層, 故 4箱 X 5層=20箱外箱
Placement of carton on pallet: 4 boxes of carton on one layer, a total of 5 layers, so 4 boxes X 5 layers = 20 boxes of carton

4. 外圍加打包帶及外部封塑膠膜
Packing tape and plastic film outside

X-ON Electronics

Largest Supplier of Electrical and Electronic Components

Click to view similar products for [TFT Displays & Accessories category](#):

Click to view products by [Powertip manufacturer](#):

Other Similar products are found below :

[OAI-80038AA-2013-A](#) [HDA430T-3G1H](#) [NB-ATT01](#) [TCG104SVLQAPNN-AN20](#) [OAI-80038AA-2008-A](#) [315-U004B15300](#) [EIC-LCD-1080P](#) [NL10276BC20-18C](#) [DEM 128160D](#) [TMH-PW-N](#) [RFE43BU-AIW-DNG](#) [EA WF050-40S](#) [EA WF050-40ST](#) [RFC350X-AWW-DNG](#) [RFS390E-AWW-DNN](#) [DEM 480272G2](#) [VMX-PW-N \(A-TOUCH\)](#) [PH800480T013-ICA](#) [DEM 1024600N](#) [VMX-PW-N \(C-TOUCH\)](#) [DEM 1024600P](#) [VMH-PW-N \(C-TOUCH\)](#) [SM-RVT50HQHNWCA0](#) [DEM 240280A](#) [VMH-PW-N](#) [DEM 170320A](#) [VMH-PW-N](#) [PH240320T068-LAB08](#) [DEM 800480T1](#) [TMH-PW-N](#) [PH128128T041-LAA07](#) [PH480272T005-IAC02](#) [DEM 1024600P](#) [VMH-PW-N \(A-TOUCH\)](#) [DEM 800480T1](#) [TMH-PW-N \(C-TOUCH\)](#) [DEM 800480Q4](#) [VMX-PW-N](#) [DEM 800480T1](#) [TMH-PW-N \(A-TOUCH\)](#) [PH320240T-023-I02Q](#) [PH128800T004-ZZA01](#) [RFE430W-1YW-DBS](#) [DEM 1024600N](#) [VMX-PW-N \(A-TOUCH\)](#) [PH240320T074-ZAA01](#) [DEM 480480D](#) [VMX-PW-N \(C-TOUCH\)](#) [SM-RVT50HQSNWN00](#) [SM-RVT50HQHNWC00](#) [PH800480T033-ICB01](#) [RFE430W-AWW-DNN](#) [DEM 096096A](#) [VMH-PW-N](#) [RL0F00050000FGAAASA01](#) [SM-RVT50HQSNWCA0](#) [SM-RVT50HQSNWC00-B](#) [PH320240T028-ZEA01](#) [RFE430W-1YW-DBN](#) [SM-RVT50HQHNWC00-B](#) [DEM 120240A](#) [VMH-PW-N](#) [DEM 268800A](#) [VMH-PW-N](#) [RFF700B4-AIW-DNS](#) [DEM 800480O1](#) [VMH-PW-N](#)