

SPECIFICATIONS

CUSTOMER	:	
SAMPLE CODE	:	SH240320T074-ZAA01
MASS PRODUCTION CODE	:	PH240320T074-ZAA01
SAMPLE VERSION	:	01
SPECIFICATIONS EDITION	:	007
DRAWING NO. (Ver.)	:	LMD- PH240320T074-ZAA 01(Ver.002)
PACKAGING NO. (Ver.)	:	PKG- PH240320T074-ZAA 01(Ver.002)

Customer Approved

Date:

Approved	Checked	Designer
黃秋源 Oliver Huang	石建莊 Stone Shin	劉俊毅 Terry Liu

- Preliminary specification for design input
- Specification for sample approval

POWERTIP TECH. CORP.

Headquarters:

No.8, 6th Road, Taichung Industrial Park,
 Taichung, Taiwan
 台中市 407 工業區六路 8 號

TEL: 886-4-2355-8168
 FAX: 886-4-2355-8166

E-mail: sales@powertip.com.tw
[Http://www.powertip.com.tw](http://www.powertip.com.tw)

History of Version

Date	Ver.	Edi.	Description	Page	Design by
08/30/2018	01	001	New Drawing.	-	Terry
11/09/2018	01	002	New Sample	-	Terry
12/19/2018	01	003	Modify LCD Type	-	Terry
04/10/2019	01	004	Modify Drawing.	-	Terry
03/210/2020	01	005	Update Drawing.	-	Terry
12/17/2020	01	006	Update LED Life Time	9	Terry
11/09/2021	01	007	Update LCM Packaging	Appendix	Terry

Contents

1. SPECIFICATIONS

- 1.1 Features
- 1.2 Mechanical Specifications
- 1.3 Absolute Maximum Ratings
- 1.4 DC Electrical Characteristics
- 1.5 Optical Characteristics
- 1.6 Backlight Characteristics

2. MODULE STRUCTURE

- 2.1 Counter Drawing
- 2.2 Interface Pin Description
- 2.3 Timing Characteristics
- 2.4 Refer Initial Code

3. QUALITY ASSURANCE SYSTEM

- 3.1 Quality Assurance Flow Chart
- 3.2 Inspection Specification

4. RELIABILITY TEST

- 4.1 Reliability Test Condition

5. PRECAUTION RELATING PRODUCT HANDLING

- 5.1 Safety
- 5.2 Handling
- 5.3 Storage
- 5.4 Terms of Warranty

Appendix : LCM Drawing
LCM Packaging Specifications

Note: For detailed information please refer to IC data sheet: ST7789VI

1. SPECIFICATIONS

1.1 Features

Item	Standard Value
Display Type	240 (RGB) * 320 Dots
LCD Type	Full Viewing Angle , Normally Black, Transmissive type
Screen size(inch)	2.0 inch
Color configuration	RGB-Strip
Display Colors	Full Color: 262K (RGB= 666, Idle Mode Off)
Backlight Type	LED B/L
Interface	16-bit / 18-bit 80-system
ROHS	THIS PRODUCT CONFORMS THE ROHS OF PTC Detail information please refer website : http://www.powertip.com.tw/news_detail.php?Key=1&cID=1

1.2 Mechanical Specifications

Item	Standard Value	Unit
Outline Dimension	36.1(W) * 51.0 (L) * 2.05 (H)	mm

LCD Panel

Item	Standard Value	Unit
Viewing Area	31.6 (W) * 41.8(L)	mm
Active Area	30.6 (W) * 40.8 (L)	mm
Pixel Pitch	0.1275(H) x 0.1275(V)	mm

Note : For detailed information please refer to LCM drawing

1.3 Absolute Maximum Ratings

Module

Item	Symbol	Condition	Min.	Max.	Unit
System Power Supply Voltage	VCC / VCI	-	-0.3	+4.6	V
	IOVCC	-	-0.3	+4.6	V
	VGH ~ VGL	-	-0.3	+30	V
Logic Input Voltage Range	VIN	-	-0.3	IOVCC+0.5	V
Operating Temperature	T _{OP}	-	-20	+70	°C
Storage Temperature	T _{ST}	-	-30	+80	°C
Storage Humidity	H _D	T _a ≤ 60 °C	-	90	%RH

1.4 DC Electrical Characteristics

Module

GND = 0V, T_a = 25°C

Item	Symbol	Condition	Min.	Typ.	Max.	Unit
Power Supply for Analog, Digital System	VCC / VCI	-	2.4	2.8	3.6	V
Power Supply for I/O System	IOVCC	-	1.65	1.8	3.6	V
Input Signal Voltage	V _{IH}	-	0.7IOVCC	-	IOVCC	V
	V _{IL}	-	GND	-	0.3 IOVCC	V
Output Signal Voltage	V _{OH}	-	0.8 IOVCC	-	IOVCC	V
	V _{OL}	-	GND	-	0.2 IOVCC	V
Supply Current	I _{CC} / I _{CI}	VCC / VCI=2.8V IOVCC=2.8V Pattern= Black *1	-	9	14	mA

Note1: Maximum current display.

1.5 Optical Characteristics

TFT LCD Panel

Ta=25°C

Item	Symbol	Condition	Min.	Typ.	Max.	unit		
Response time	$T_r + T_f$	Ta = 25°C $\theta_X, \theta_Y = 0^\circ$	-	30	40	ms	Note 2	
Viewing angle	Top	θ_{Y+}	CR ≥ 10	-	80	-	Deg.	Note 4
	Bottom	θ_{Y-}		-	80	-		
	Left	θ_{X-}		-	80	-		
	Right	θ_{X+}		-	80	-		
Contrast ratio	CR		650	800	-	-	Note 3	
Color of CIE Coordinate (With B/L)	White	x	Ta = 25°C $\theta_X, \theta_Y = 0^\circ$	0.25	0.30	0.35	-	Note1
		y		0.27	0.32	0.37		
	Red	x		0.59	0.64	0.69		
		y		0.28	0.33	0.38		
	Green	x		0.28	0.33	0.38		
		y		0.56	0.61	0.66		
	Blue	x		0.09	0.14	0.19		
		y		0.03	0.08	0.13		
Average Brightness Pattern=white display (With LCD)*1	IV	IF= 60 mA	200	250		-	Note1	
Uniformity (With LCD)*2	ΔB	IF=60 mA	80	-	-	%	Note1	
Color gamut of CF (NTSC%)	S	-	54	60	-	%	-	

Note 1:

*1 : $\Delta B = B(\min) / B(\max) * 100\%$

*2 : Measurement Condition for Optical Characteristics:

a : Environment: $25^{\circ}\text{C} \pm 5^{\circ}\text{C}$ / $60 \pm 20\%$ R.H , no wind , dark room below 10 Lux at typical lamp current and typical operating frequency.

b : Measurement Distance: 500 ± 50 mm , ($\theta = 0^{\circ}$)

c : Equipment: TOPCON BM-7 fast , (field 1°) , after 10 minutes operation.

d : The uncertainty of the C.I.E coordinate measurement ± 0.01 , Average Brightness $\pm 4\%$

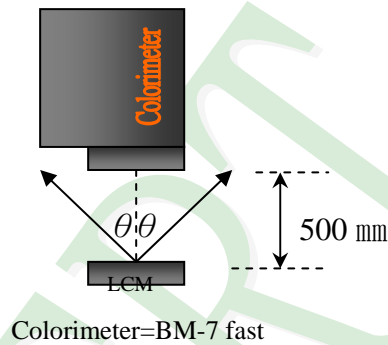
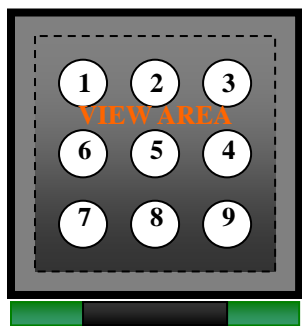

To be measured at the center area of panel with a viewing cone of 1° by Topcon luminance meter BM-7, after 10 minutes operation (module)

Note2: Definition of response time:

The output signals of photo detector are measured when the input signals are changed from "black" to "white"(falling time) and from "white" to "black"(rising time), respectively. The response time is defined as the time interval between the 10% and 90% of Amplitudes.

Refer to figure as below:

Normally White



Normally Black

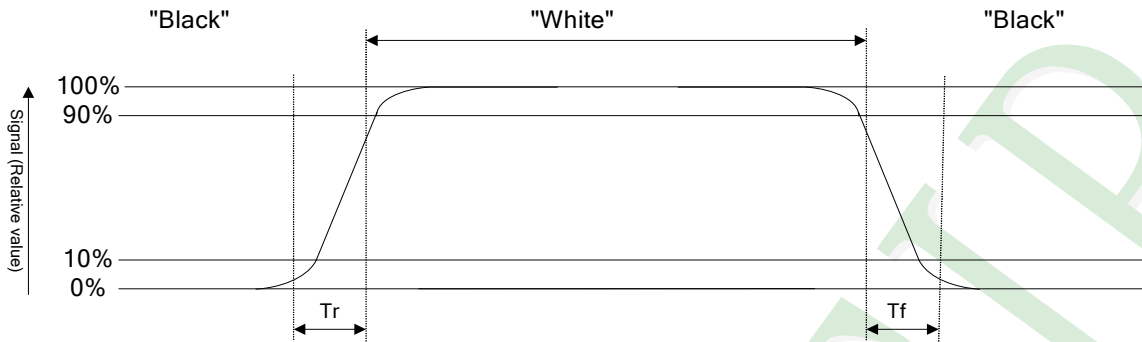

Note3: Definition of contrast ratio:

Contrast ratio is calculated with the following formula

$$\text{Contrast ratio (CR)} = \frac{\text{Photo detector output when LCD is at "White" state}}{\text{Photo detector output when LCD is at "Black" state}}$$

Note4: Definition of viewing angle:

Refer to figure as below:

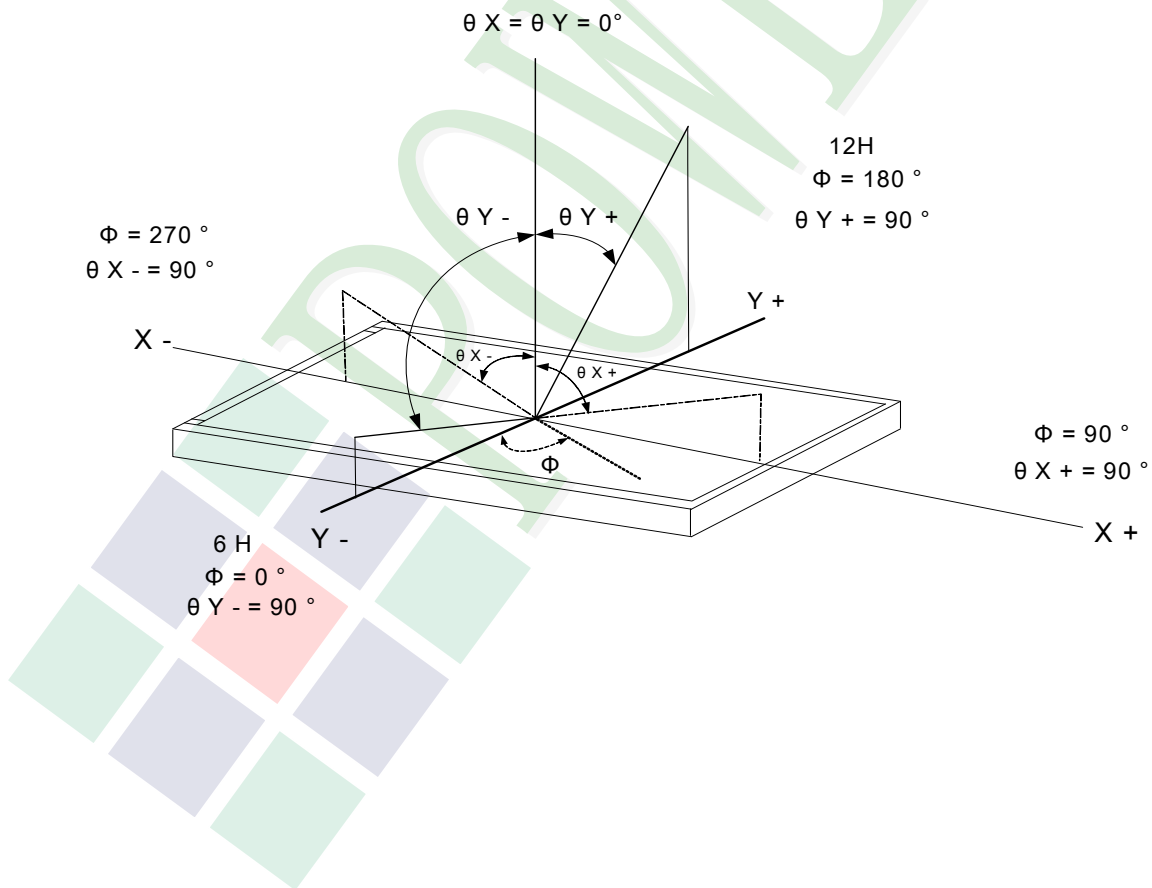

1.6 Backlight Characteristics

Maximum Ratings

Item	Symbol	Conditions	Min.	Max.	Unit	Remark
LED Forward Current	IF	Ta =25°C	-	25	mA	Each LED
LED Reverse Voltage	VR	Ta =25°C	-	5	V	Each LED
Power Dissipation	PD	Ta =25°C	-	85	mW	-

Backlight Characteristics

Item	Symbol	Conditions	Min.	Typ.	Max.	Unit
Forward Voltage	VF	IF=60mA (Without LCD)	2.7	3.1	3.5	V
Color	White					
LED life time	30000hr					

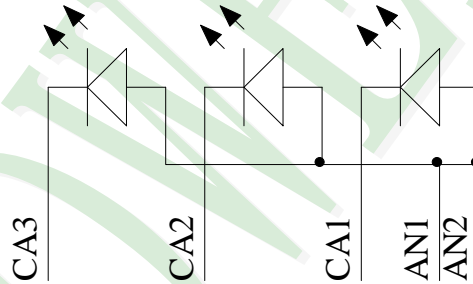

2. MODULE STRUCTURE

2.1 Counter Drawing

2.1.1 LCM Mechanical Diagram

* See Appendix

2.1.2 Block Diagram

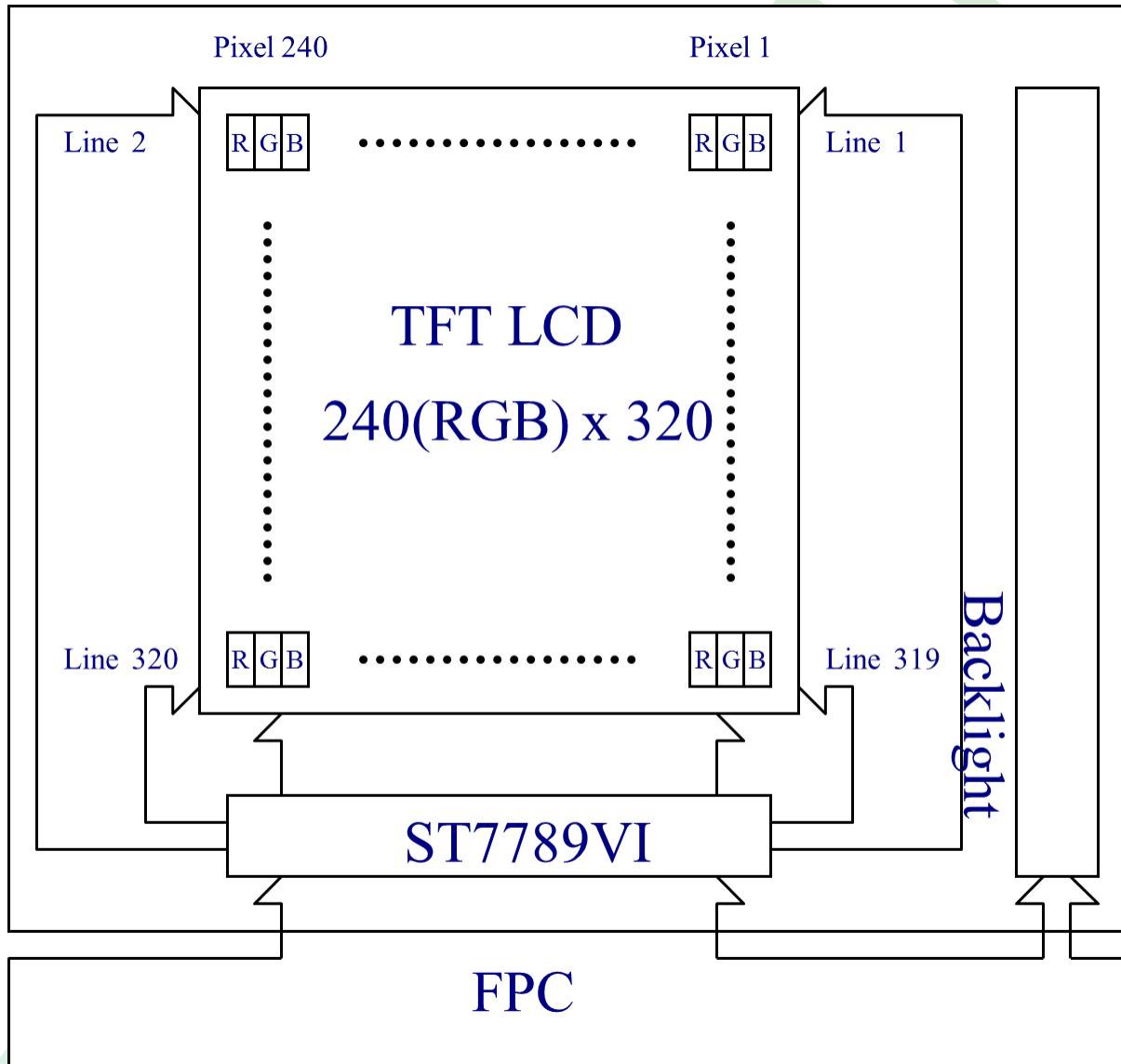

2.2 Interface Pin Description

Pin No.	Symbol	Function
1	GND	System Ground
2	CA3	LED Cathode
3	CA2	LED Cathode
4	CA1	LED Cathode
5	AN1	LED Anode
6	AN2	LED Anode
7	VCC / VCI	Power Supply for Analog, Digital System and Booster Circuit
8	VCC / VCI	
9	IOVCC	Power Supply for I/O System
10	IOVCC	
11	TE	Tearing effect signal is used to synchronize MCU to frame memory
12	CSX	Chip selection pin Low enable. High disable.
13	DCX	Display data/command selection pin in parallel interface. This pin is used to be serial interface clock. DCX='1' : display data or parameter. DCX='0' : command data.
14	WRX	Write enable in MCU parallel interface.
15	RDX	Read enable in 8080 MCU parallel interface.
16	RESX	This signal will reset the device and it must be applied to properly initialize the chip. Signal is active low.
17	IM1	The MCU interface mode select IM1='1' : 80-18bit parallel I/F IM1='0' : 80-16bit parallel I/F

Pin No.	Symbol	Function
18	DB0	DB[17:0] are used as MCU parallel interface data bus. 16-bit I/F: DB[15:0] are used; 18-bit I/F: DB[17:0] are used. If not used, please fix this pin at IOVCC or GND.
19	DB1	
20	DB2	
21	DB3	
22	DB4	
23	DB5	
24	DB6	
25	DB7	
26	DB8	
27	DB9	
28	DB10	
29	DB11	
30	DB12	
31	DB13	
32	DB14	
33	DB15	
34	DB16	
35	DB17	
36	GND	System Ground
37	NC	NC
38	NC	NC
39	NC	NC
40	NC	NC

2.3 Timing Characteristics

8080 Series MCU Parallel Interface Characteristics: 18/16/9/8-bit Bus

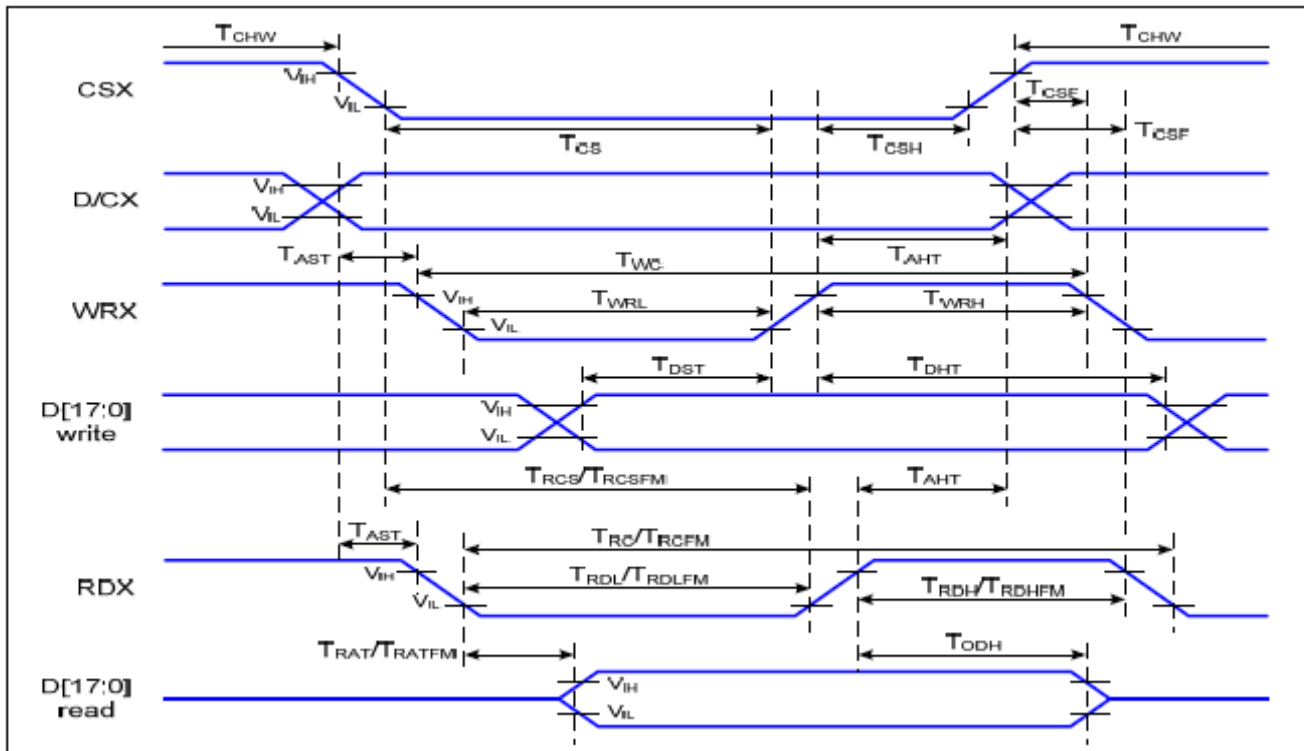

Parallel Interface Timing Characteristics (8080-Series MCU Interface)

VDDI=1.65 to 3.6V, VDD=2.4 to 3.6V, AGND=DGND=0V, Ta= 25 °C

Signal	Symbol	Parameter	Min	Max	Unit	Description
D/CX	T _{AST}	Address setup time	0		ns	
	T _{AHT}	Address hold time (Write/Read)	10		ns	
CSX	T _{CHW}	Chip select "H" pulse width	0		ns	
	T _{CS}	Chip select setup time (Write)	15		ns	
	T _{RCS}	Chip select setup time (Read ID)	45		ns	
	T _{RCSFM}	Chip select setup time (Read FM)	355		ns	
	T _{CSF}	Chip select wait time (Write/Read)	10		ns	
	T _{CSH}	Chip select hold time	10		ns	
WRX	T _{WC}	Write cycle	66		ns	
	T _{WRH}	Control pulse "H" duration	15		ns	
	T _{WRL}	Control pulse "L" duration	15		ns	
RDX (ID)	T _{RC}	Read cycle (ID)	160		ns	When read ID data
	T _{RDH}	Control pulse "H" duration (ID)	90		ns	
	T _{RDL}	Control pulse "L" duration (ID)	45		ns	
RDX (FM)	T _{RCFM}	Read cycle (FM)	450		ns	When read from frame memory
	T _{RDHFM}	Control pulse "H" duration (FM)	90		ns	
	T _{RDLFM}	Control pulse "L" duration (FM)	355		ns	
D[17:0]	T _{DST}	Data setup time	10		ns	For CL=30pF

8080 Parallel Interface Characteristics

T_{DHT}	Data hold time	10		ns
T_{RAT}	Read access time (ID)		40	ns
T_{RATFM}	Read access time (FM)		340	ns
T_{ODH}	Output disable time	20	80	ns

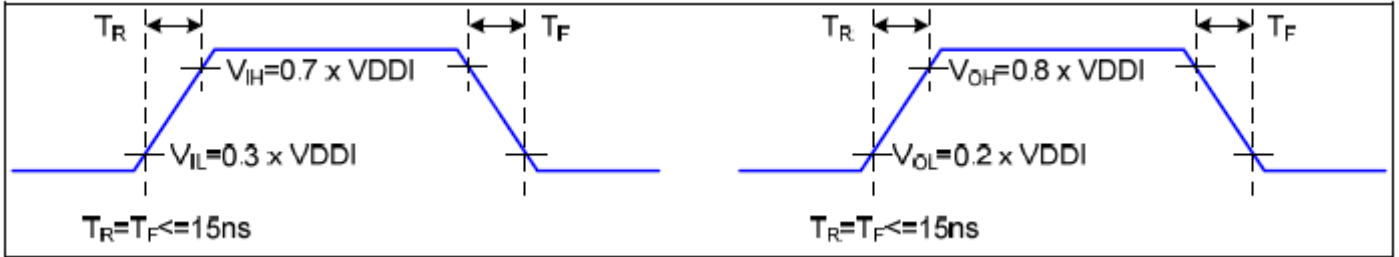
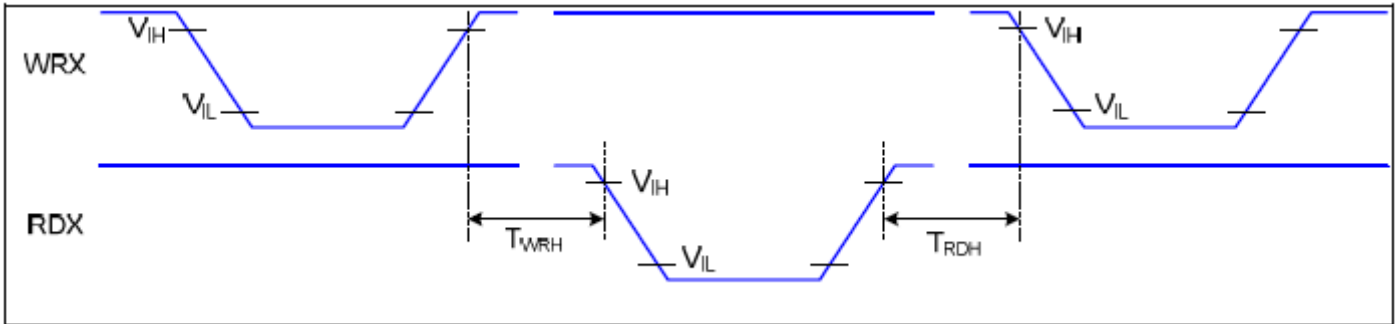
Rising and Falling Timing for I/O Signal

Write-to-Read and Read-to-Write Timing

2.4 Refer Initial Code

```
HW_Reset();
```

```
Delay(120); //ms
```

```
Write(Command , 0x11);
```

```
Delay(120); //ms
```

```
Write(Command , 0x36);
```

```
Write(Parameter , 0x00);
```

```
Write(Command , 0x3A);
```

```
Write(Parameter , 0x05); 05 16bit ,06 18bit
```

```
Write(Command , 0xB2);
```

```
Write(Parameter , 0x0C);
```

```
Write(Parameter , 0x0C);
```

```
Write(Parameter , 0x00);
```

```
Write(Parameter , 0x33);
```

```
Write(Parameter , 0x33);
```

```
Write(Command , 0xB7);
```

```
Write(Parameter , 0x35);
```

```
Write(Command , 0xBB);
```

```
Write(Parameter , 0x21);
```

```
Write(Command , 0xC0);
```

```
Write(Parameter , 0x2C);
```

```
Write(Command , 0xC2);
```

```
Write(Parameter , 0x01);
```

```
Write(Command , 0xC3);
```

```
Write(Parameter , 0x0B);
```

```
Write(Command , 0xC4);
```

```
Write(Parameter , 0x20);
```

```
Write(Command , 0xC6);
```

```
Write(Parameter , 0x0F);
```

```
Write(Command , 0xD0);
```

```
Write(Parameter , 0xA4);
```

```
Write(Parameter , 0xA1);
```

```
Write(Command , 0x21);
```

```
Write(Command , 0xE0);
```

```
Write(Parameter , 0x70);  
Write(Parameter , 0x04);  
Write(Parameter , 0x08);  
Write(Parameter , 0x07);  
Write(Parameter , 0x06);  
Write(Parameter , 0x23);  
Write(Parameter , 0x29);  
Write(Parameter , 0x32);  
Write(Parameter , 0x41);  
Write(Parameter , 0x38);  
Write(Parameter , 0x15);  
Write(Parameter , 0x16);  
Write(Parameter , 0x27);  
Write(Parameter , 0x2C);
```

```
Write(Command , 0xE1);  
Write(Parameter , 0x70);  
Write(Parameter , 0x01);  
Write(Parameter , 0x05);  
Write(Parameter , 0x08);  
Write(Parameter , 0x07);  
Write(Parameter , 0x04);  
Write(Parameter , 0x27);  
Write(Parameter , 0x44);  
Write(Parameter , 0x42);  
Write(Parameter , 0x0A);  
Write(Parameter , 0x16);  
Write(Parameter , 0x14);  
Write(Parameter , 0x2B);  
Write(Parameter , 0x2F);
```

```
Write(Command , 0x29);
```

3. QUALITY ASSURANCE SYSTEM

3.1 Quality Assurance Flow Chart

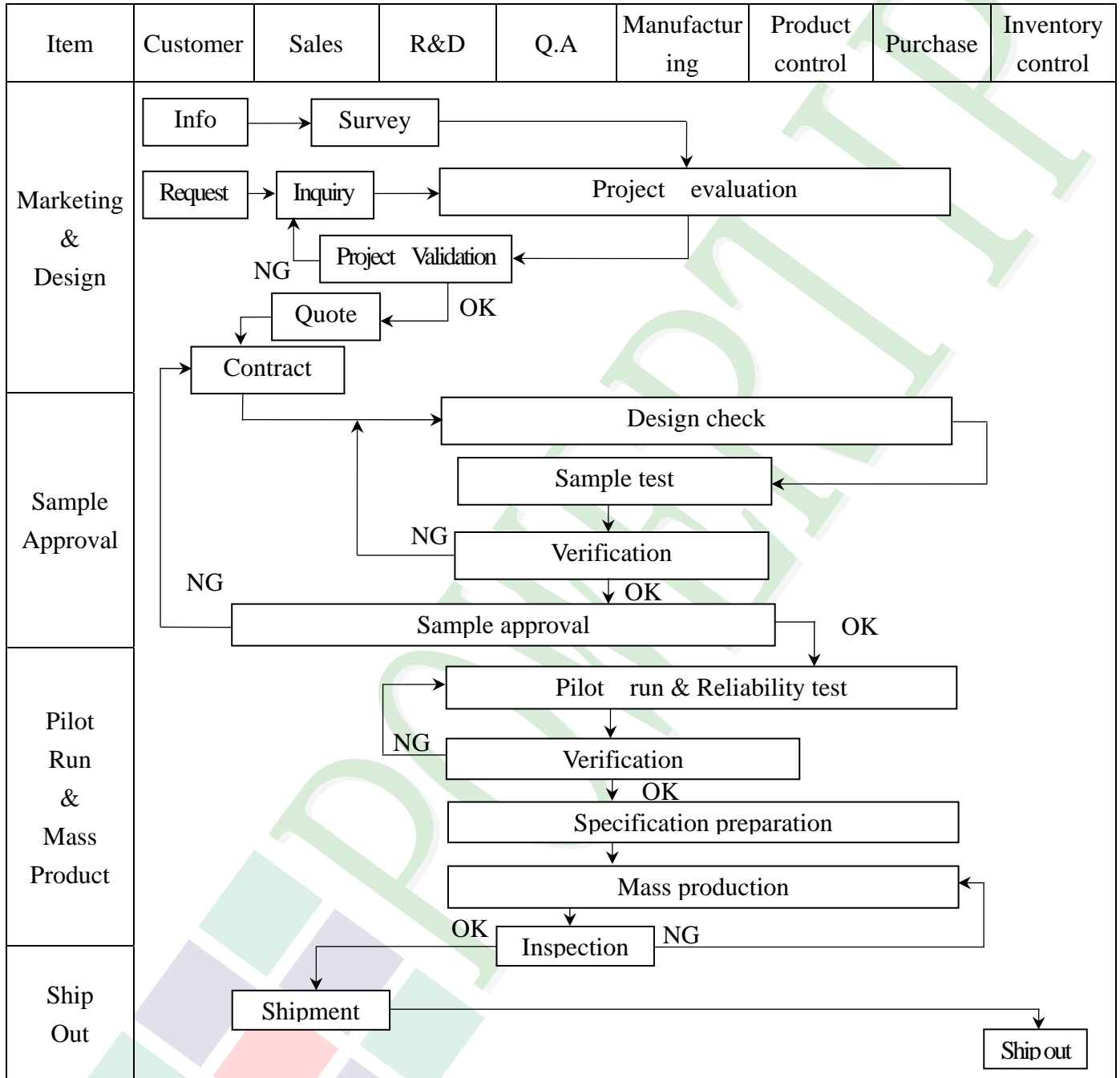

3.2. Inspection Specification

- ◆Scope : The document shall be applied to TFT-LCD Module for less than 3.5" (Ver.B01).
- ◆Inspection Standard : MIL-STD-105E Table Normal Inspection Single Sampling Level II.
- ◆Equipment : Gauge 、 MIL-STD 、 Powertip Tester 、 Sample
- ◆Defect Level : Major Defect AQL : 0.4 ; Minor Defect AQL : 1.5
- ◆OUT Going Defect Level : Sampling.
- ◆Standard of the product appearance test :

a. Manner of appearance test :

- (1). The test best be under 20W×2 fluorescent light , and distance of view must be at 30 cm.
- (2). The test direction is base on about around 45° of vertical line.

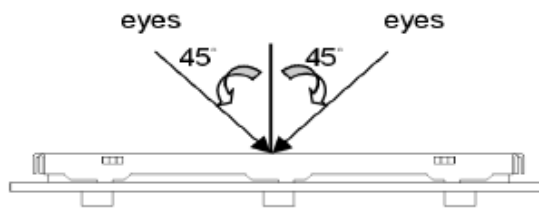

(3). Definition of area.

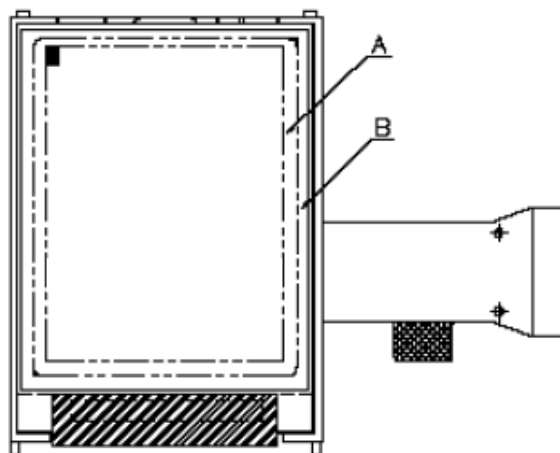

A area : viewing area

B area : Outside of viewing area

(4). Standard of inspection : (Unit : mm)



◆Specification For TFT-LCD Module Less Than 3.5" :

(Ver.B01)

NO	Item	Criterion	Level												
01	Product condition	1. 1 The part number is inconsistent with work order of production.	Major												
		1. 2 Mixed product types.	Major												
		1. 3 Assembled in inverse direction.	Major												
02	Quantity	2. 1 The quantity is inconsistent with work order of production.	Major												
03	Outline dimension	3. 1 Product dimension and structure must conform to structure diagram.	Major												
04	Electrical Testing	4. 1 Missing line character and icon.	Major												
		4. 2 No function or no display.	Major												
		4. 3 Display malfunction.	Major												
		4. 4 LCD viewing angle defect.	Major												
		4. 5 Current consumption exceeds product specifications.	Major												
		4. 6 Mura can not be seen through 5% ND filter, should be judged by the viewing angle of 90 degree.	Minor												
05	Dot defect (Bright dot 、 Dark dot) On -display	<table border="1" style="margin-left: auto; margin-right: auto;"> <thead> <tr> <th colspan="2">Item</th> <th>Acceptance (Q'ty)</th> </tr> </thead> <tbody> <tr> <td rowspan="4" style="text-align: center; vertical-align: middle;">Dot Defect</td> <td style="text-align: center;">Bright Dot</td> <td style="text-align: center;">≤ 2</td> </tr> <tr> <td style="text-align: center;">Dark Dot</td> <td style="text-align: center;">≤ 3</td> </tr> <tr> <td style="text-align: center;">Joint Dot</td> <td style="text-align: center;">≤ 2</td> </tr> <tr> <td style="text-align: center;">Total</td> <td style="text-align: center;">≤ 3</td> </tr> </tbody> </table>	Item		Acceptance (Q'ty)	Dot Defect	Bright Dot	≤ 2	Dark Dot	≤ 3	Joint Dot	≤ 2	Total	≤ 3	Minor
		Item		Acceptance (Q'ty)											
Dot Defect	Bright Dot	≤ 2													
	Dark Dot	≤ 3													
	Joint Dot	≤ 2													
	Total	≤ 3													
5. 1 Inspection pattern : full white , full black , Red , Green and blue screens. 5. 2 It is defined as dot defect if defect area $> 1/2$ dot. 5. 3 The distance between two dot defect ≥ 5 mm. 5. 4 Bright dot that can not be seen through 5% ND filter.															

◆ Specification For TFT-LCD Module Less Than 3.5" :

(Ver.B01)

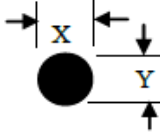
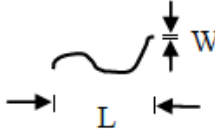
NO	Item	Criterion	Level																																										
06	<p>Black or white dot、scratch、contamination</p> <p>Round type</p>  <p>$\Phi = (x + y) / 2$</p> <p>Line type</p> 	<p>6.1 Round type (Non-display or display) :</p> <table border="1" data-bbox="555 432 1329 882"> <thead> <tr> <th rowspan="2">Dimension (diameter : Φ)</th> <th colspan="2">Acceptance (Q'ty)</th> </tr> <tr> <th>A area</th> <th>B area</th> </tr> </thead> <tbody> <tr> <td>$\Phi \leq 0.15$</td> <td colspan="2">Ignore</td> </tr> <tr> <td>$0.15 < \Phi \leq 0.20$</td> <td colspan="2">2</td> </tr> <tr> <td>$0.20 < \Phi \leq 0.30$</td> <td colspan="2">2</td> </tr> <tr> <td>$\Phi > 0.30$</td> <td colspan="2">0</td> </tr> <tr> <td>Total</td> <td colspan="2">3</td> </tr> </tbody> </table> <p>6.2 Line type(Non-display or display) :</p> <table border="1" data-bbox="539 999 1347 1413"> <thead> <tr> <th colspan="2">Dimension</th> <th colspan="2">Acceptance (Q'ty)</th> </tr> <tr> <th>Length (L)</th> <th>Width (W)</th> <th>A area</th> <th>B area</th> </tr> </thead> <tbody> <tr> <td>---</td> <td>$W \leq 0.03$</td> <td>Ignore</td> <td rowspan="3">Ignore</td> </tr> <tr> <td>$L \leq 5.0$</td> <td>$0.03 < W \leq 0.05$</td> <td>3</td> </tr> <tr> <td>---</td> <td>$W > 0.05$</td> <td>As round type</td> </tr> <tr> <td colspan="2">Total</td> <td colspan="2">3</td> </tr> </tbody> </table>	Dimension (diameter : Φ)	Acceptance (Q'ty)		A area	B area	$\Phi \leq 0.15$	Ignore		$0.15 < \Phi \leq 0.20$	2		$0.20 < \Phi \leq 0.30$	2		$\Phi > 0.30$	0		Total	3		Dimension		Acceptance (Q'ty)		Length (L)	Width (W)	A area	B area	---	$W \leq 0.03$	Ignore	Ignore	$L \leq 5.0$	$0.03 < W \leq 0.05$	3	---	$W > 0.05$	As round type	Total		3		Minor
Dimension (diameter : Φ)	Acceptance (Q'ty)																																												
	A area	B area																																											
$\Phi \leq 0.15$	Ignore																																												
$0.15 < \Phi \leq 0.20$	2																																												
$0.20 < \Phi \leq 0.30$	2																																												
$\Phi > 0.30$	0																																												
Total	3																																												
Dimension		Acceptance (Q'ty)																																											
Length (L)	Width (W)	A area	B area																																										
---	$W \leq 0.03$	Ignore	Ignore																																										
$L \leq 5.0$	$0.03 < W \leq 0.05$	3																																											
---	$W > 0.05$	As round type																																											
Total		3																																											
07	Polarizer Bubble	<table border="1" data-bbox="547 1462 1339 1872"> <thead> <tr> <th rowspan="2">Dimension (diameter : Φ)</th> <th colspan="2">Acceptance (Q'ty)</th> </tr> <tr> <th>A area</th> <th>B area</th> </tr> </thead> <tbody> <tr> <td>$\Phi \leq 0.20$</td> <td colspan="2">Ignore</td> </tr> <tr> <td>$0.20 < \Phi \leq 0.50$</td> <td colspan="2">3</td> </tr> <tr> <td>$\Phi > 0.50$</td> <td colspan="2">0</td> </tr> <tr> <td>Total</td> <td colspan="2">3</td> </tr> </tbody> </table>	Dimension (diameter : Φ)	Acceptance (Q'ty)		A area	B area	$\Phi \leq 0.20$	Ignore		$0.20 < \Phi \leq 0.50$	3		$\Phi > 0.50$	0		Total	3		Minor																									
Dimension (diameter : Φ)	Acceptance (Q'ty)																																												
	A area	B area																																											
$\Phi \leq 0.20$	Ignore																																												
$0.20 < \Phi \leq 0.50$	3																																												
$\Phi > 0.50$	0																																												
Total	3																																												

◆ Specification For TFT-LCD Module Less Than 3.5" :

(Ver.B01)

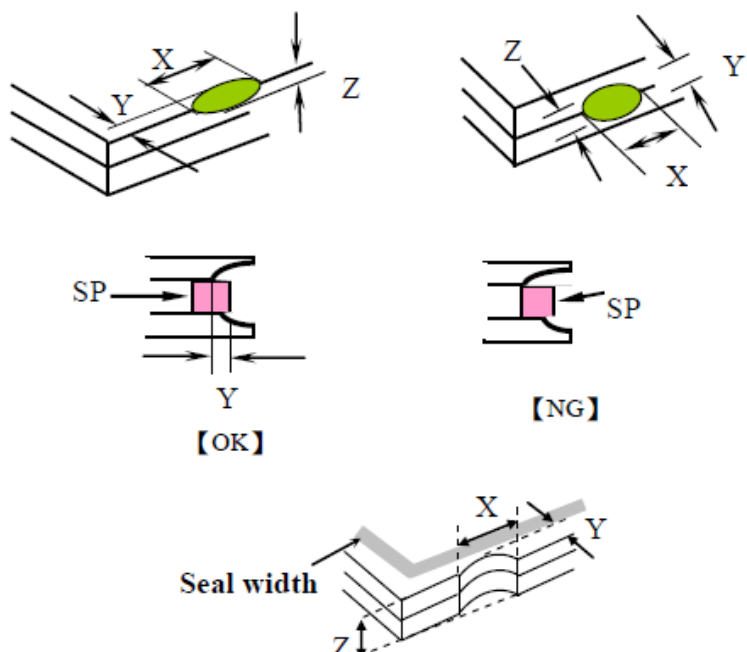
NO	Item	Criterion	Level						
08	The crack of glass	<p>Symbols :</p> <p>X : The length of crack Z : The thickness of crack t : The thickness of glass</p> <p>Y : The width of crack. W : terminal length a : LCD side length</p>	Minor						
		<p>8.1 General glass chip :</p> <p>8.1.1 Chip on panel surface and crack between panels:</p>  <table border="1" data-bbox="547 1440 1337 1724"> <thead> <tr> <th>X</th> <th>Y</th> <th>Z</th> </tr> </thead> <tbody> <tr> <td>$\leq a$</td> <td>Crack can't enter viewing area</td> <td>$\leq 1/2 t$</td> </tr> <tr> <td>$\leq a$</td> <td>Crack can't exceed the half of SP width.</td> <td>$1/2 t < Z \leq 2 t$</td> </tr> </tbody> </table>		X	Y	Z	$\leq a$	Crack can't enter viewing area	$\leq 1/2 t$
X	Y	Z							
$\leq a$	Crack can't enter viewing area	$\leq 1/2 t$							
$\leq a$	Crack can't exceed the half of SP width.	$1/2 t < Z \leq 2 t$							

◆ Specification For TFT-LCD Module Less Than 3.5" :

(Ver.B01)

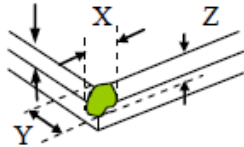
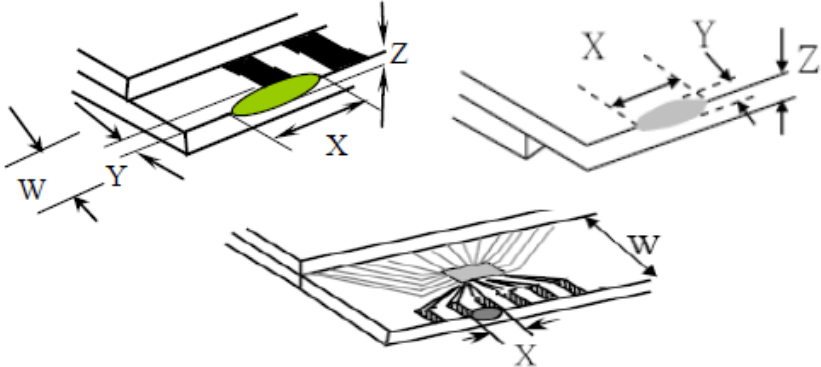
NO	Item	Criterion	Level									
08	The crack of glass	<p>Symbols :</p> <p>X : The length of crack Y : The width of crack. Z : The thickness of crack W : terminal length t : The thickness of glass a : LCD side length</p>	Minor									
		<p>8.1.2 Corner crack :</p>  <table border="1" data-bbox="536 792 1331 1077"> <thead> <tr> <th>X</th> <th>Y</th> <th>Z</th> </tr> </thead> <tbody> <tr> <td>$\leq 1/5 a$</td> <td>Crack can't enter viewing area</td> <td>$Z \leq 1/2 t$</td> </tr> <tr> <td>$\leq 1/5 a$</td> <td>Crack can't exceed the half of SP width.</td> <td>$1/2 t < Z \leq 2 t$</td> </tr> </tbody> </table>		X	Y	Z	$\leq 1/5 a$	Crack can't enter viewing area	$Z \leq 1/2 t$	$\leq 1/5 a$	Crack can't exceed the half of SP width.	$1/2 t < Z \leq 2 t$
		X		Y	Z							
$\leq 1/5 a$	Crack can't enter viewing area	$Z \leq 1/2 t$										
$\leq 1/5 a$	Crack can't exceed the half of SP width.	$1/2 t < Z \leq 2 t$										
<p>8.2 Protrusion over terminal :</p> <p>8.2.1 Chip on electrode pad :</p>  <table border="1" data-bbox="572 1666 1339 1839"> <thead> <tr> <th></th> <th>X</th> <th>Y</th> <th>Z</th> </tr> </thead> <tbody> <tr> <td>Front</td> <td>$\leq a$</td> <td>$\leq 1/2 W$</td> <td>$\leq t$</td> </tr> <tr> <td>Back</td> <td>$\leq a$</td> <td>$\leq W$</td> <td>$\leq 1/2 t$</td> </tr> </tbody> </table>		X	Y	Z	Front	$\leq a$	$\leq 1/2 W$	$\leq t$	Back	$\leq a$	$\leq W$	$\leq 1/2 t$
	X	Y	Z									
Front	$\leq a$	$\leq 1/2 W$	$\leq t$									
Back	$\leq a$	$\leq W$	$\leq 1/2 t$									

◆Specification For TFT-LCD Module Less Than 3.5" :

(Ver.B01)

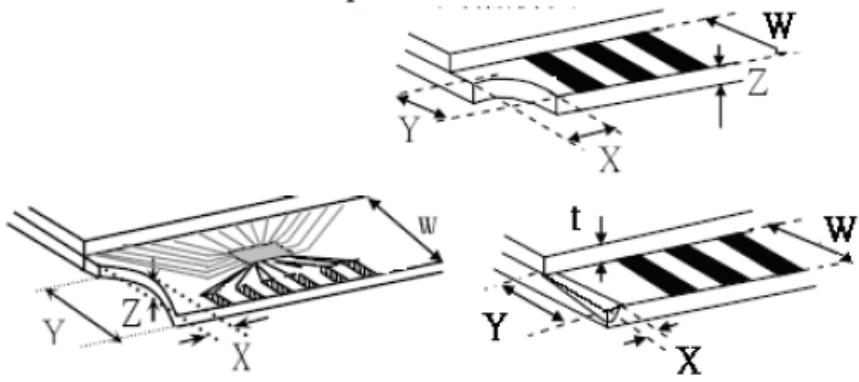
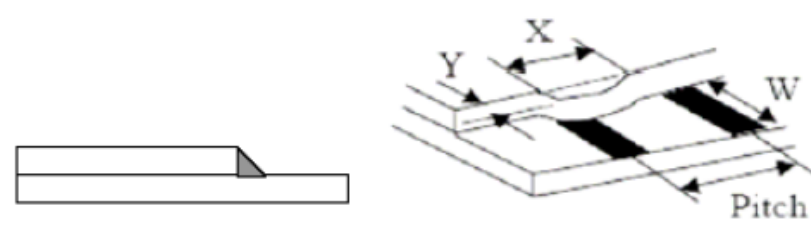
NO	Item	Criterion	Level									
08	The crack of glass	<p>Symbols :</p> <p>X : The length of crack Y : The width of crack. Z : The thickness of crack W : terminal length t : The thickness of glass a : LCD side length</p>	Minor									
		<p>8.2.2 Non-conductive portion :</p>  <table border="1" data-bbox="622 963 1244 1120"> <thead> <tr> <th>X</th> <th>Y</th> <th>Z</th> </tr> </thead> <tbody> <tr> <td>$\leq 1/3 a$</td> <td>$\leq W$</td> <td>$\leq t$</td> </tr> </tbody> </table> <p>⊙ If the chipped area touches the ITO terminal, over 2/3 of the ITO must remain and be inspected according to electrode terminal specifications.</p> <p>8.2.3 Glass remain :</p>  <table border="1" data-bbox="542 1747 1228 1881"> <thead> <tr> <th>X</th> <th>Y</th> <th>Z</th> </tr> </thead> <tbody> <tr> <td>$\leq a$</td> <td>$\leq 1/3 W$</td> <td>$\leq t$</td> </tr> </tbody> </table>		X	Y	Z	$\leq 1/3 a$	$\leq W$	$\leq t$	X	Y	Z
X	Y	Z										
$\leq 1/3 a$	$\leq W$	$\leq t$										
X	Y	Z										
$\leq a$	$\leq 1/3 W$	$\leq t$										

◆ Specification For TFT-LCD Module Less Than 3.5" :

(Ver.B01)

NO	Item	Criterion	Level
09	Backlight elements	9.1 Backlight can't work normally.	Major
		9.2 Backlight doesn't light or color is wrong.	Major
		9.3 Illumination source flickers when lit.	Major
10	General appearance	10.1 Pin type 、 quantity 、 dimension must match type in structure diagram.	Major
		10.2 No short circuits in components on PCB or FPC .	Major
		10.3 Parts on PCB or FPC must be the same as on the production characteristic chart .There should be no wrong parts , missing parts or excess parts.	Major
		10.4 Product packaging must the same as specified on packaging specification sheet.	Minor
		10.5 The folding and peeled off in polarizer are not acceptable.	Minor
		10.6 The PCB or FPC between B/L assembled distance(PCB or FPC) is ≤ 1.5 mm.	Minor

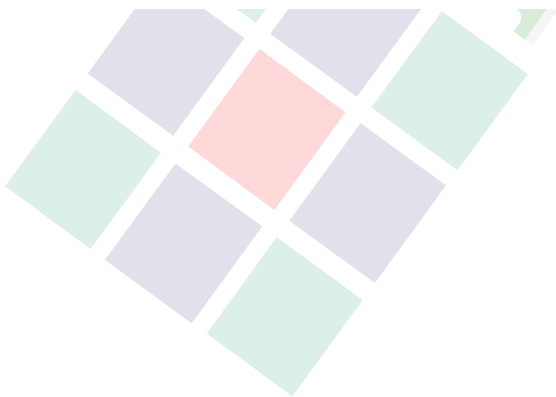

4. RELIABILITY TEST

4.1 Reliability Test Condition

(Ver.B01)

NO.	TEST ITEM	TEST CONDITION											
1	High Temperature Storage Test	Keep in $80 \pm 5^{\circ}\text{C}$ 96 hrs											
2	Low Temperature Storage Test	Keep in $-30 \pm 5^{\circ}\text{C}$ 96 hrs											
3	High Temperature / High Humidity Storage Test	Keep in 60°C / 90% R.H duration for 96 hrs (Excluding the polarizer)											
4	Temperature Cycling Storage Test	$ \begin{array}{c} -30^{\circ}\text{C} \rightarrow +25^{\circ}\text{C} \rightarrow 80^{\circ}\text{C} \rightarrow +25^{\circ}\text{C} \\ (30\text{mins}) \quad (5\text{mins}) \quad (30\text{mins}) \quad (5\text{mins}) \\ \longleftarrow \hspace{10em} \longrightarrow \\ 20 \text{ Cycle} \end{array} $											
5	ESD Test	Air Discharge: Apply 2 KV with 5 times Discharge for each polarity +/-	Contact Discharge: Apply 250 V with 5 times discharge for each polarity +/-										
		1. Temperature ambience : $15^{\circ}\text{C} \sim 35^{\circ}\text{C}$ 2. Humidity relative : 30%~60% 3. Energy Storage Capacitance(Cs+Cd) : $150\text{pF} \pm 10\%$ 4. Discharge Resistance(Rd) : $330 \Omega \pm 10\%$ 5. Discharge, mode of operation : Single Discharge (time between successive discharges at least 1 sec) (Tolerance if the output voltage indication : $\pm 5\%$)											
6	Vibration Test (Packaged)	1. Sine wave $10 \sim 55$ Hz frequency (1 min/sweep) 2. The amplitude of vibration : 1.5 mm 3. Each direction (X、Y、Z) duration for 2 Hrs											
7	Drop Test (Packaged)	<table border="1"> <thead> <tr> <th>Packing Weight (Kg)</th> <th>Drop Height (cm)</th> </tr> </thead> <tbody> <tr> <td>0 ~ 45.4</td> <td>122</td> </tr> <tr> <td>45.4 ~ 90.8</td> <td>76</td> </tr> <tr> <td>90.8 ~ 454</td> <td>61</td> </tr> <tr> <td>Over 454</td> <td>46</td> </tr> </tbody> </table>		Packing Weight (Kg)	Drop Height (cm)	0 ~ 45.4	122	45.4 ~ 90.8	76	90.8 ~ 454	61	Over 454	46
		Packing Weight (Kg)	Drop Height (cm)										
0 ~ 45.4	122												
45.4 ~ 90.8	76												
90.8 ~ 454	61												
Over 454	46												
		Drop Direction :※1 corner / 3 edges / 6 sides each 1time											

◎Result Evaluation Criteria :

Under the display quality test conditions with normal operations with normal operation state.
Do not change these conditions as such changes may affect practical display function.

(Normal operation state)

Temperature : $+20 \sim 30^{\circ}\text{C}$

Humidity : 50~70%

Atmospheric pressure : 86~106Kpa

5. PRECAUTION RELATING PRODUCT HANDLING

5.1 SAFETY

- 5.1.1 If the LCD panel breaks, be careful not to get the liquid crystal to touch your skin.
- 5.1.2 If the liquid crystal touches your skin or clothes, please wash it off immediately by using soap and water.

5.2 HANDLING

- 5.2.1 Avoid any strong mechanical shock which can break the glass.
- 5.2.2 Avoid static electricity which can damage the CMOS LSI—When working with the module, be sure to ground your body and any electrical equipment you may be using.
- 5.2.3 Do not remove the panel or frame from the module.
- 5.2.4 The polarizing plate of the display is very fragile. So, please handle it very carefully, do not touch, push or rub the exposed polarizing with anything harder than an HB pencil lead (glass, tweezers, etc.)
- 5.2.5 Do not wipe the polarizing plate with a dry cloth, as it may easily scratch the surface of plate.
- 5.2.6 Do not touch the display area with bare hands, this will stain the display area.
- 5.2.7 Do not use ketonics solvent & aromatic solvent. Use with a soft cloth soaked with a cleaning naphtha solvent.
- 5.2.8 To control temperature and time of soldering is $320 \pm 10^{\circ}\text{C}$ and 3-5 sec.
- 5.2.9 To avoid liquid (include organic solvent) stained on LCM
- 5.2.10 Caution!(LCM products with Capacitive Touch Panel)
Strong EMI-sources such as switch-mode power supplies (SMPS) can lead to touch malfunction (e.g. ghost-touches).
Therefore, the touch needs to be thoroughly tested inside the target application.
- 5.2.11 CAUTION: Continuously displaying same static image will result in high possibility of image sticking/image burn-in effect due to TFT panel characteristic.
- 5.2.12 Double-sided tape designed to be attach with the customer's mechanical device, please follow up the rules and regulations published by the original manufacturer of double-sided tape for the attachment operation.

5.3 STORAGE

- 5.3.1 Store the panel or module in a dark place where the temperature is $25^{\circ}\text{C} \pm 5^{\circ}\text{C}$ and the humidity is below 65% RH.
- 5.3.2 Do not place the module near organics solvents or corrosive gases.
- 5.3.3 Do not crush, shake, or jolt the module.

5.4 TERMS OF WARRANTY

- 5.4.1 Applicable warrant period The period is within thirteen months since the date of shipping out under normal using and storage conditions.
- 5.4.2 Unaccepted responsibility
This product has been manufactured to your company's specification as a part for use in your company's general electronic products. It is guaranteed to perform according to delivery specifications. For any other use apart from general electronic equipment, we cannot take responsibility if the product is used in nuclear power control equipment, aerospace equipment, fire and security systems or any other applications in which there is a direct risk to human life and where extremely high levels of reliability are required.

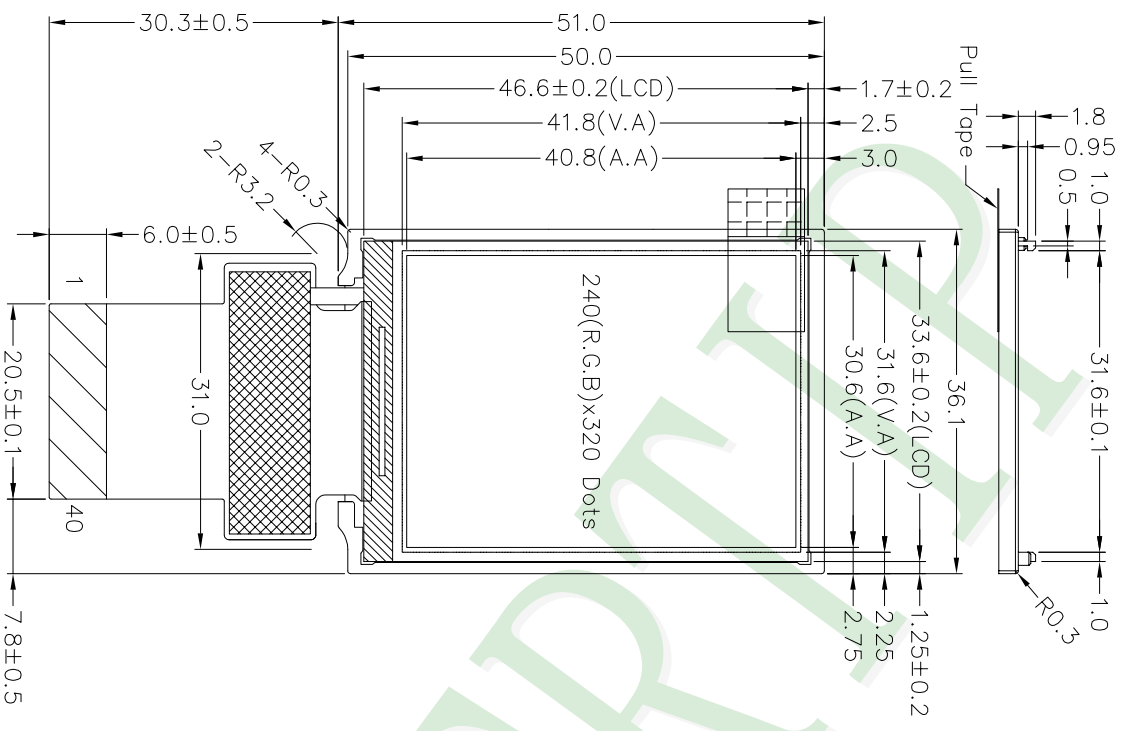

- NOTES:
- 1.LCD TYPE: TFT LCD
 - 2.LCD DISPLAY: Normally black
 - 3.The tolerance unless classified $\pm 0.2\text{mm}$
 - 4.LCM FPC suggested connector : OMRON XF2M-4015-1A or compatible.

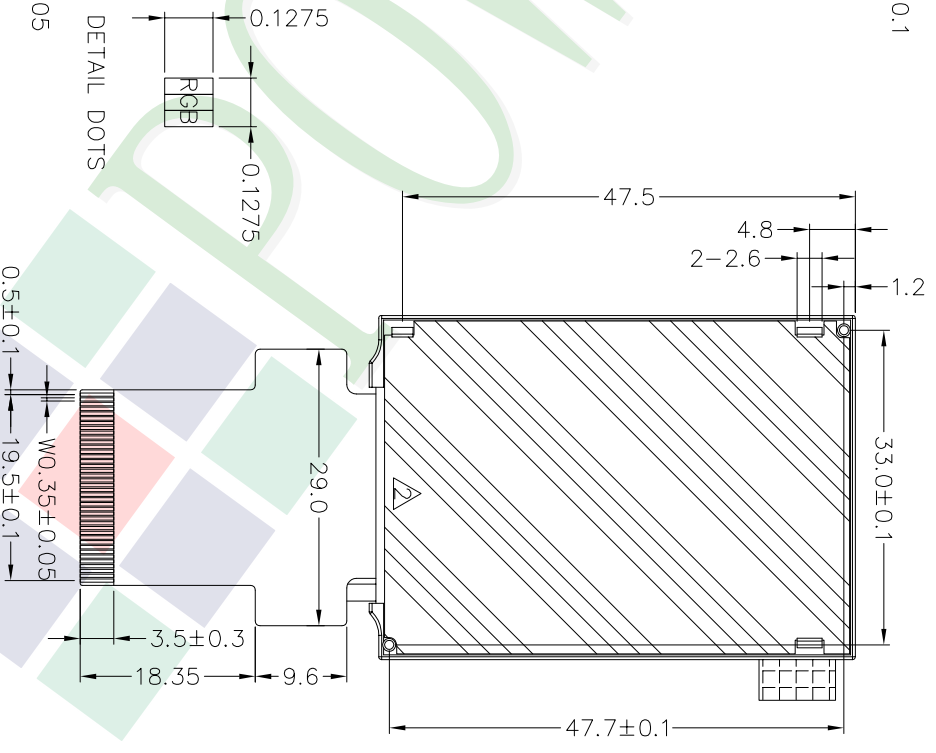
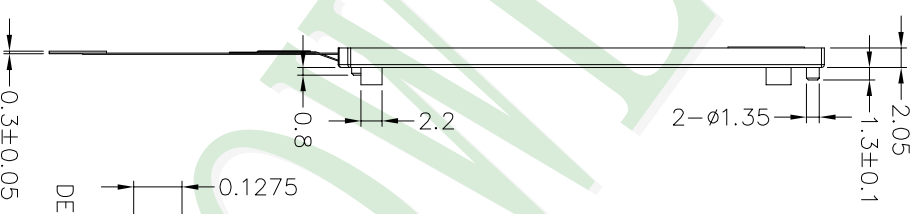

007			
006			
005			
004			
003			
002	MODIFY DRAWING	Stone	2019/04/10
001	NEW DRAWING	Stone	2018/08/30
REV	REV BY	REVISER	DATE

PART NO:	PH240320T074-ZAA01
DRAWING NAME:	LMD-PH240320T074-ZAA01
TITLE:	LCD MODULE DRAWING

Design		Stone		Surface		Precision Level	
Check	Oliver	Unit	MM	Material	1 ~ 4	1 ~ 4	-
Approve	Oliver	Scale	1:1	Thickness	16 ~ 63	16 ~ 63	-
		Page	1/1	Quantity	63 ~ 250	63 ~ 250	-
					250 ~ 1000	250 ~ 1000	-

久正光電股份有限公司
POWER TIP TECHNOLOGY CORPORATION

Ver.002

LCM包裝規格書

Documents NO. PKG-PH240320T074-ZAA01

LCM Packaging Specifications
(For Tray)

Approve	Check	Contact
Oliver	Oliver	Stone

1. 包裝材料規格表 (Packaging Material) : (per carton)

No.	Item	Model	Dimensions (mm)	1Pcs Weight	Quantity	Total Weight
1	成品 (LCD)	PH240320T074-ZAA01	51.0 X 36.1	0.0056	576	3.2256
2	多層薄膜(1)POF	OTFILM0BA03ABA	—————	——	6	——
3	TRAY 盤 (2)Tray	TYSG000000481	352 X 260 X 13.0	0.1	42	4.2
4	內盒(3)Product Box	BX36627063ABBA	383 X 270 X 66	0.2692	6	1.6152
5	保利龍板(4)Polylon board	OTPLB00PL08ABA	550 X 393 X 20	0.0284	2	0.0568
6	外紙箱(5)Carton	BX57041027CCBA	570 X 410 X 265	1.4208	1	1.4208
7						
8						
9						

2. 一整箱總重量 (Total LCD Weight in carton) : 10.52 Kg±10%

3. 單箱數量規格表 (Packaging Specifications and Quantity) :

(1)LCD quantity per box : no per tray	16	x no of tray	6	=	96
(2)Total LCD quantity in carton : quantity per box	96	x no of boxes	6	=	576

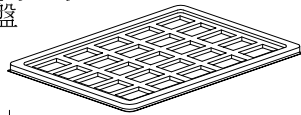
Use empty tray
空盤

+

Put products into the tray

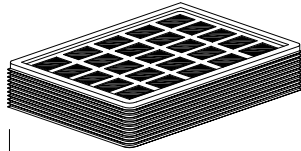

↓

Tray stacking

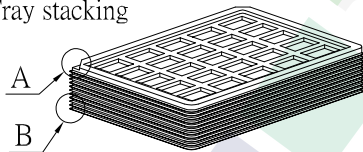
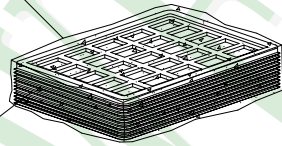
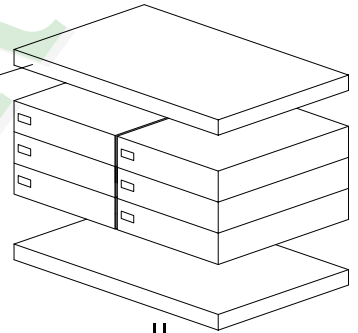
(1)多層薄膜
POF(4)保利龍板
Polylon board

↓

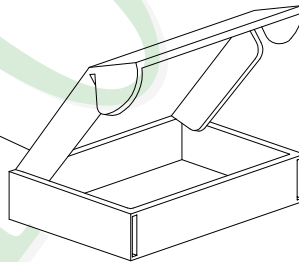
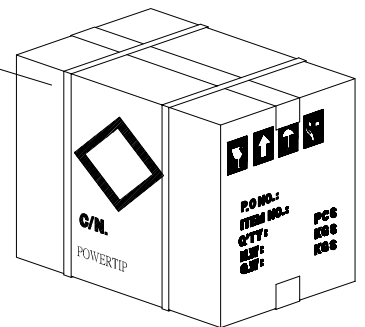
(2)TRAY 盤
Tray(3)內盒
Product Box(5)外紙箱
Carton

特 記 事 項 (REMARK)

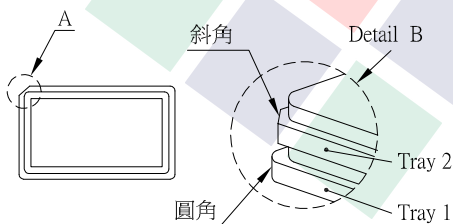

5. TRAY盤相疊時,需旋轉180度,請詳見B視圖
Rotate tray 180 degrees and place on top of stack.
Check the tray stack using Fig. B.

X-ON Electronics

Largest Supplier of Electrical and Electronic Components

Click to view similar products for [TFT Displays & Accessories category](#):

Click to view products by [Powertip manufacturer](#):

Other Similar products are found below :

[OAI-80038AA-2013-A](#) [HDA430T-3G1H](#) [T-51750GD065J-LW-BGN](#) [NB-ATT01](#) [NL8060BC26-35C](#) [TCG104SVLQAPNN-AN20](#) [OAI-80038AA-2008-A](#) [315-U004B15300](#) [EIC-LCD-1080P](#) [NL10276BC20-18C](#) [NLB121XG01L-01](#) [DEM 128160D](#) [TMH-PW-N](#) [RFE43BU-AIW-DNG](#) [RFC350X-AWW-DNG](#) [RFS390E-AWW-DNN](#) [DEM 480272G2](#) [VMX-PW-N \(A-TOUCH\)](#) [PH800480T013-ICA](#) [DEM 1024600N](#) [VMX-PW-N \(C-TOUCH\)](#) [DEM 1024600P](#) [VMH-PW-N \(C-TOUCH\)](#) [SM-RVT50HQHNWCA0](#) [DEM 240280A](#) [VMH-PW-N](#) [DEM 170320A](#) [VMH-PW-N](#) [PH240320T068-LAB08](#) [DEM 800480T1](#) [TMH-PW-N](#) [PH128128T041-LAA07](#) [DEM 800480Q4](#) [VMX-PW-N \(A-TOUCH\)](#) [PH480272T005-IAC02](#) [DEM 1024600P](#) [VMH-PW-N \(A-TOUCH\)](#) [DEM 800480T1](#) [TMH-PW-N \(C-TOUCH\)](#) [DEM 800480Q4](#) [VMX-PW-N](#) [DEM 800480T1](#) [TMH-PW-N \(A-TOUCH\)](#) [PH320240T-023-I02Q](#) [PH128800T004-ZZA01](#) [RFE430W-1YW-DBS](#) [DEM 1024600N](#) [VMX-PW-N \(A-TOUCH\)](#) [PH240320T074-ZAA01](#) [DEM 480480D](#) [VMX-PW-N \(C-TOUCH\)](#) [SM-RVT50HQSNWN00](#) [SM-RVT50HQHNWC00](#) [PH800480T033-ICB01](#) [RFE430W-AWW-DNN](#) [DEM 096096A](#) [VMH-PW-N](#) [RL0F00050000FGAAASA01](#) [PH320480T009-LAA01](#) [SM-RVT50HQSNWCA0](#) [SM-RVT50HQSNWC00-B](#) [PH320240T028-ZEA01](#) [RFE430W-1YW-DBN](#) [SM-RVT50HQLFWN00](#) [SM-RVT50HQHNWC00-B](#)