

SPECIFICATIONS

CUSTOMER	:	
SAMPLE CODE	:	SH320240T-023-I02Q
MASS PRODUCTION CODE	:	PH320240T-023-I02Q
SAMPLE VERSION	:	01
SPECIFICATIONS EDITION	:	008
DRAWING NO. (Ver.)	:	LMD-PH320240T-023-I02Q (Ver.002)
PACKAGING NO. (Ver.)	:	PKG-PH320240T-023-I02Q (Ver.001)

Customer Approved

Date:

Approved	Checked	Designer
黃秋源 Oliver Huang	石建莊 Stone Shin	黃俊清 Ackey Huang

- Preliminary specification for design input
- Specification for sample approval

POWER TIP TECH. CORP.

Headquarters: No.8, 6 th Road, Taichung Industrial Park, Taichung, Taiwan 台中市 407 工業區六路 8 號	TEL: 886-4-2355-8168 FAX: 886-4-2355-8166	E-mail: sales@powertip.com.tw Http://www.powertip.com.tw
---------------------------------------------------------------------------------------------------------------------	----------------------------------------------	--------------------------------------------------------------------------------------------------------

Contents

1. SPECIFICATIONS

- 1.1 Features
- 1.2 Mechanical Specifications
- 1.3 Absolute Maximum Ratings
- 1.4 DC Electrical Characteristics
- 1.5 Optical Characteristics
- 1.6 Backlight Characteristics

2. MODULE STRUCTURE

- 2.1 Counter Drawing
- 2.2 Interface Pin Description
 - 2.2.1 Refer Initial code
- 2.3 Timing Characteristics

3. QUALITY ASSURANCE SYSTEM

- 3.1 Quality Assurance Flow Chart
- 3.2 Inspection Specification

4. RELIABILITY TEST

- 4.1 Reliability Test Condition

5. PRECAUTION RELATING PRODUCT HANDLING

- 5.1 Safety
- 5.2 Handling
- 5.3 Storage
- 5.4 Terms of Warranty

Appendix : LCM Drawing

LCM Packaging Specifications

Note : For detailed information please refer to IC data sheet :

Primacy(TFT LCD): Himax: HX8238-D

1. SPECIFICATIONS

1.1 Features

Main LCD Panel

Item	Standard Value
Display Type	320* (R · G · B) * 240 Dots
LCD Type	Normally white , Transmissive type
Screen size(inch)	3.5(Diagonal)
Viewing Direction	6 O'clock
Color configuration	R.G.B. vertical stripe
Backlight	White LED
Interface	Digital 24-bits Parallel RGB HSYNC,VSYNC.3Wires SPI
Other (controller / driver IC)	Himax: HX8238-D
ROHS	THIS PRODUCT CONFORMS THE ROHS OF PTC Detail information please refer website : http://www.powertip.com.tw/news_detail.php?Key=1&cID=1

1.2 Mechanical Specifications

Item	Standard Value	Unit
Outline Dimension	76.9(W) * 63.9 (L) * 3.2 (H)	mm

LCD panel

Item	Standard Value	Unit
Active Area	70.08 (W) * 52.56 (L)	mm

Note : For detailed information please refer to LCM drawing

1.3 Absolute Maximum Ratings

Module

Item	Symbol	Condition	Min.	Max.	Unit
System Power Supply Voltage	VDD	GND=0	-0.3	4.0	V
Booster Reference Supply Voltage	VCI	GND=0	GND-0.3	3.96	V
Operating Temperature	T _{OP}	-	-20	70	°C
Storage Temperature	T _{ST}	-	-30	80	°C
Storage Humidity	HD	Ta < 60 °C	20	90	%RH

1.4 DC Electrical Characteristics

Module

GND = 0V, Ta = 25 °C

Item	Symbol	Condition	Min.	Typ.	Max.	Unit
Power Supply Voltage	VDD	-	3.0	3.3	3.6	V
Booster Reference Supply Voltage	VCI	-	3.0	3.3	3.6	V
V _{COM} High Voltage	V _{COMH}	-	-	-	5.54	V
V _{COM} Low Voltage	V _{COML}	-	-2.8	-	-	V
Input H/L Level Voltage	V _{IH}	-	0.8VDD	-	VDD	V
	V _{IL}	-	0	-	0.2VDD	V
Output H/L Level Voltage	V _{OH}	-	0.9VDD	-	VDD	V
	V _{OL}	-	-	-	0.1VDD	V
Supply Current	I _{DD}	VDD=VCI=3.3V Pattern= black*1	-	9	14	mA

Note1: Maximum current display.

1.5 Optical Characteristics

TFT LCD Panel

VDD=VCI=3.3V, Ta=25°C

Item	Symbol	Condition	Min.	Typ.	Max.	unit	-
Response time	Tr + Tf	Ta = 25°C θX, θY = 0°	-	40	60	ms	Note2
Viewing angle	Top	CR ≥ 10	-	60	-	Deg.	Note4
	Bottom		-	60	-		
	Left		-	60	-		
	Right		-	60	-		
Contrast ratio	CR		500	600	-	-	Note3
Color of CIE Coordinate (With B/L)	White	X	0.26	0.31	0.36	-	Note1
		Y	0.28	0.33	0.38		
	Red	X	0.57	0.62	0.67		
		Y	0.32	0.37	0.42		
	Green	X	0.29	0.34	0.39		
		Y	0.56	0.61	0.66		
	Blue	X	0.09	0.14	0.19		
		Y	0.03	0.08	0.13		
Average Brightness Pattern=white display	IV	IF= 20 mA	400	500	-	cd/m ²	Note1
Uniformity	△B		80	-	-	%	Note1

Note1:

1 : $\Delta B = B(\min) / B(\max) \times 100\%$

2 : Measurement Condition for Optical Characteristics:

a : Environment: 25°C±5°C / 60±20%R.H , no wind , dark room below 10 Lux at typical lamp current and typical operating frequency.

b : Measurement Distance: 500 ± 50 mm , (θ= 0°)

c : Equipment: TOPCON BM-7 fast , (field 1°) , after 10 minutes operation.

d : The uncertainty of the C.I.E coordinate measurement ±0.01 , Average Brightness ± 4%

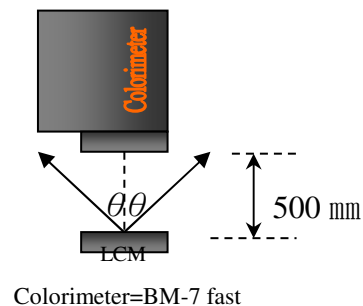
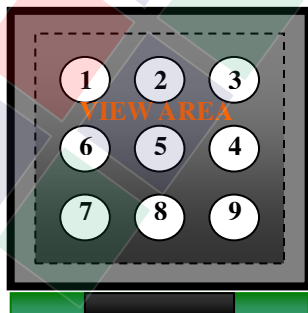

Note2: Definition of response time:

The output signals of photo detector are measured when the input signals are changed from “black” to “white”(falling time) and from “white” to “black”(rising time), respectively. The response time is defined as the time interval between the 10% and 90% of Amplitudes.

Refer to figure as below:

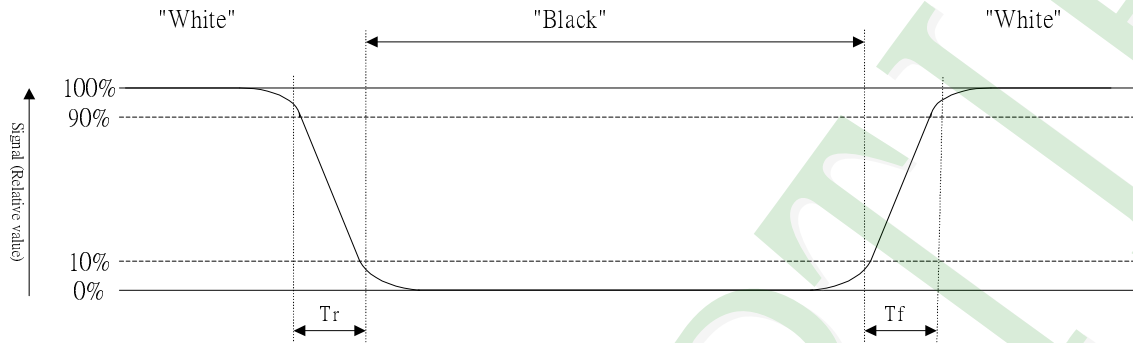

Note3: Definition of contrast ratio:

Contrast ratio is calculated with the following formula

$$\text{Contrast ratio (CR)} = \frac{\text{Photo detector output when LCD is at "White" state}}{\text{Photo detector output when LCD is at "Black" state}}$$

Note4: Definition of viewing angle:

Refer to figure as below:

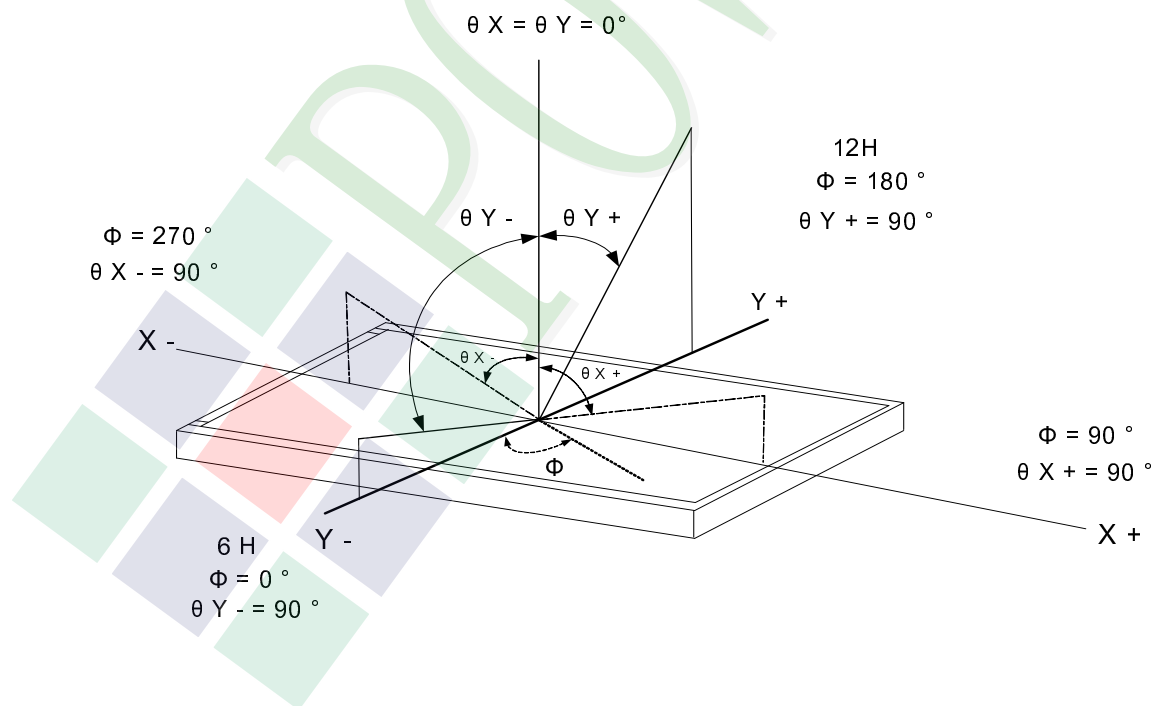

1.6 Backlight Characteristics

Maximum Ratings

Item	Symbol	Conditions	Min.	Max.	Unit
Forward Current	IF	Ta =25°C	-	30	mA
Power Dissipation	PD	Ta =25°C	-	30*21	mW

Electrical / Optical Characteristics

Item	Symbol	Conditions	Min.	Typ.	Max.	Unit
Forward Voltage	VF	IF= 20 mA	-	19.2	21	V
Color of CIE Coordinate (Without LCD & TP)	X		0.28	0.30	0.32	-
	Y		0.28	0.30	0.32	
Color	White					

Internal Circuit Diagram

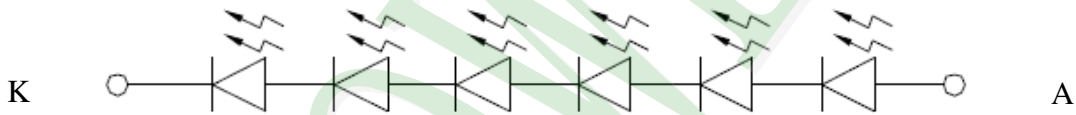

Other Description

Item	Conditions	Description
Life Time	Ta =25°C IF= 20mA	20000 hrs

2. MODULE STRUCTURE

2.1 Counter Drawing

2.1.1 LCM Mechanical Diagram

* See Appendix

2.1.2 Block Diagram

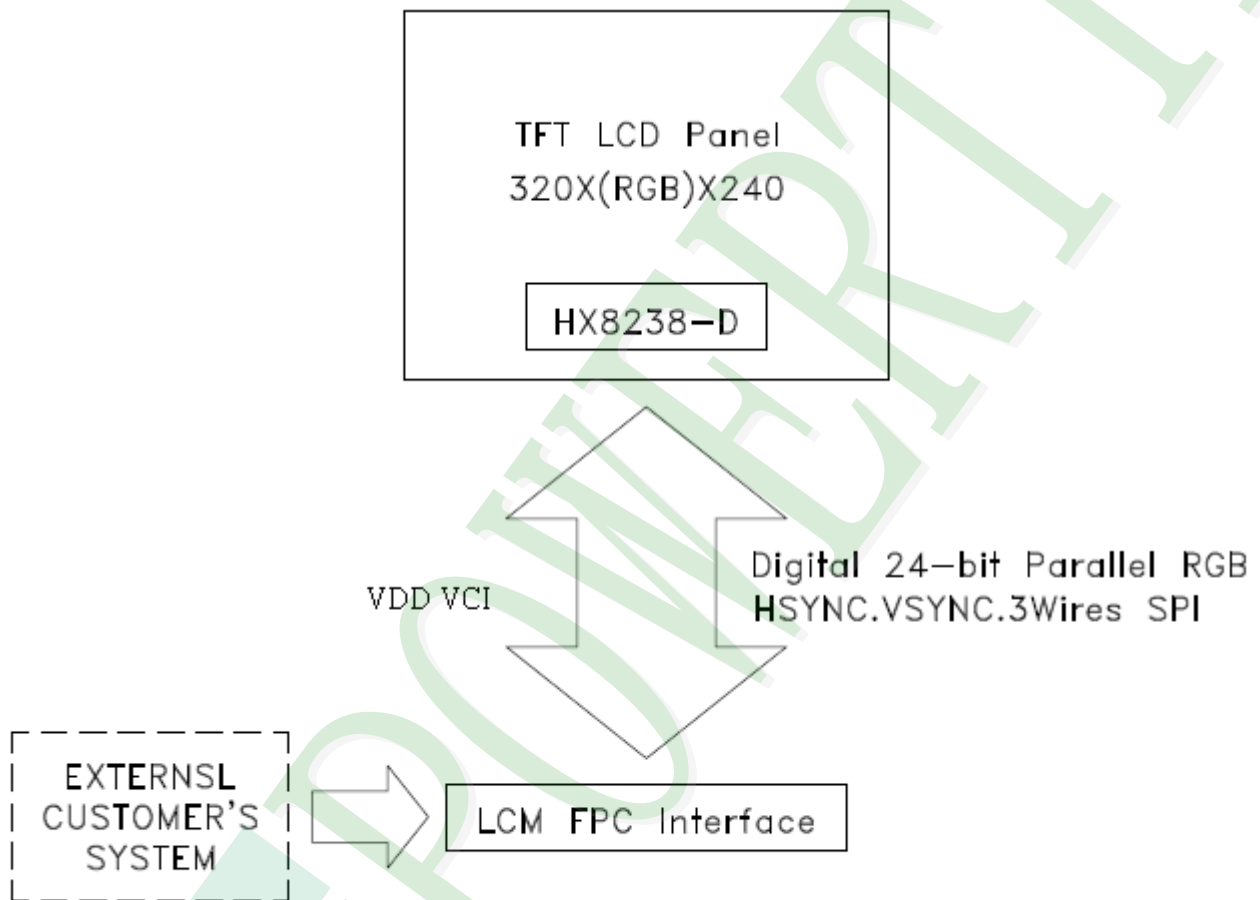

2.2 Interface Pin Description

Pin No.	Symbol	Function
1	A	LED Anode.
2	K	LED Cathode.
3	GND	Ground.
4	VCI	Booster Reference Supply Voltage.
5	ID	Note1.
6	VDD	Power Supply Voltage.
7	GND	Ground.
8	RESB	Reset.
9	CSB	Chip select Input: CSB = L - selected and accessible. CSB = H - is not selected and not accessible.
10	SCK	SPI Clock Input.
11	SDO	SPI Data Output. The data is valid on the falling edge of the SCK signal.
12	SDI	SPI Data Input. The data is latched on the rising edge of the SCK signal.
13	GND	Ground.
14	B0	Graphic display Blue data.
15	B1	
16	B2	
17	B3	
18	B4	
19	B5	
20	B6	

Pin No.	Symbol	Function
21	B7	Graphic display Blue data.
22	G0	Graphic display Green data.
23	G1	
24	G2	
25	G3	
26	G4	
27	G5	
28	G6	
29	G7	
30	R0	Graphic display Red data.
31	R1	
32	R2	
33	R3	
34	R4	
35	R5	
36	R6	
37	R7	
38	GND	Ground.
39	DCLK	Video Clock Input. The data is latched on the rising edge of DCLK.
40	HSYNC	Horizontal Sync Input.
41	VSYNC	Vertical Sync Input.

Pin No.	Symbol	Function
42	DEN	Video Data Enable Input. VSYNC+HSYNC mode - This pin is shorted to GND normally and the back/front porch is determined by the control register. VSYNC+HSYNC+DE mode - The valid data is determined by the VSYNC+HSYNC+DEN pin. DE mode - VSYNC and HSYNC are unused and shorted to GND. The valid input. data is determined by DEN pin.
43	GND	Ground.
44	SEL0	Note2.
45	SEL1	
46	SEL2	
47	Y+	Touch Panel Y_Top. (NC)
48	X+	Touch Panel X_Right.(NC)
49	Y-	Touch Panel Y_Bottom. (NC)
50	X-	Touch Panel X_Left. (NC)

Note1: ID code Circuit

Vendor ID (On FPC, ID resistor as specified in vendor table shall be connected to this pin, and other side of the resistor shall be connected to GND)

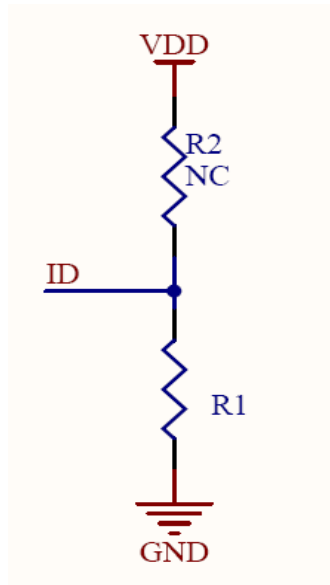

R1=44.2KΩ

Note2: Define the input interface mode

SEL2	SEL1	SEL0	Format	Operating frequency
0	0	0	Parallel-RGB data format (only support stripe type color filter)	6.5MHz
0	0	1	Serial-RGB data format	19.5MHz
0	1	0	CCIR 656 data format (640RGB)	24.54MHz
0	1	1	CCIR 656 data format (720RGB)	27MHz
1	0	0	YUV mode A data format (Cr-Y-Cb-Y)	24.54MHz
1	0	1	YUV mode A data format (Cr-Y-Cb-Y)	27MHz
1	1	0	YUV mode B data format (Cb-Y-Cr-Y)	27MHz
1	1	1	YUV mode B data format (Cb-Y-Cr-Y)	24.54MHz

Input format	DOTCLK Freq (MHz)	Display data	Active area (DOTCLK)
YUV mode	24.54	640	1280
	27	720	1440

2.2.1 Refer Initial code:

```
//Initial-----  
\void Initial_Main(void)                // For HX8238-D  
{  
  
    LCD_SPI_REG(0x0001);                //Driver output control  
    LCD_SPI_DATA(0x6300);  
  
    LCD_SPI_REG(0x0002);                //LCD-driving-waveform control  
    LCD_SPI_DATA(0x0200);                //B/C=1 line inversion waveform is generated.  
  
    LCD_SPI_REG(0x0003);                //Power control 1  
    LCD_SPI_DATA(0x6464);                //Set the step-up cycle of the step-up circuit  
  
    LCD_SPI_REG(0x0004);                //Input data and color filter control  
    LCD_SPI_DATA(0x04c7);  
  
    LCD_SPI_REG(0x0005);                //Function control(all default)  
    LCD_SPI_DATA(0xb4c4);  
  
    LCD_SPI_REG(0x0005);                //Function control(all default except DEP)  
    LCD_SPI_DATA(0xbcc4);  
  
    LCD_SPI_REG(0x0005);                //Function control  
    LCD_SPI_DATA(0xfc80);  
  
    LCD_SPI_REG(0x000a);                //Contrast/Brightness control (R0Ah)  
    LCD_SPI_DATA(0x4008);  
  
    LCD_SPI_REG(0x000d);                // Power control 2  
    LCD_SPI_DATA(0x0231);  
  
    LCD_SPI_REG(0x000e);                //Power control 3  
    LCD_SPI_DATA(0x2e80);  
  
    delay_ms(100);  
}
```

2.3 Timing Characteristics

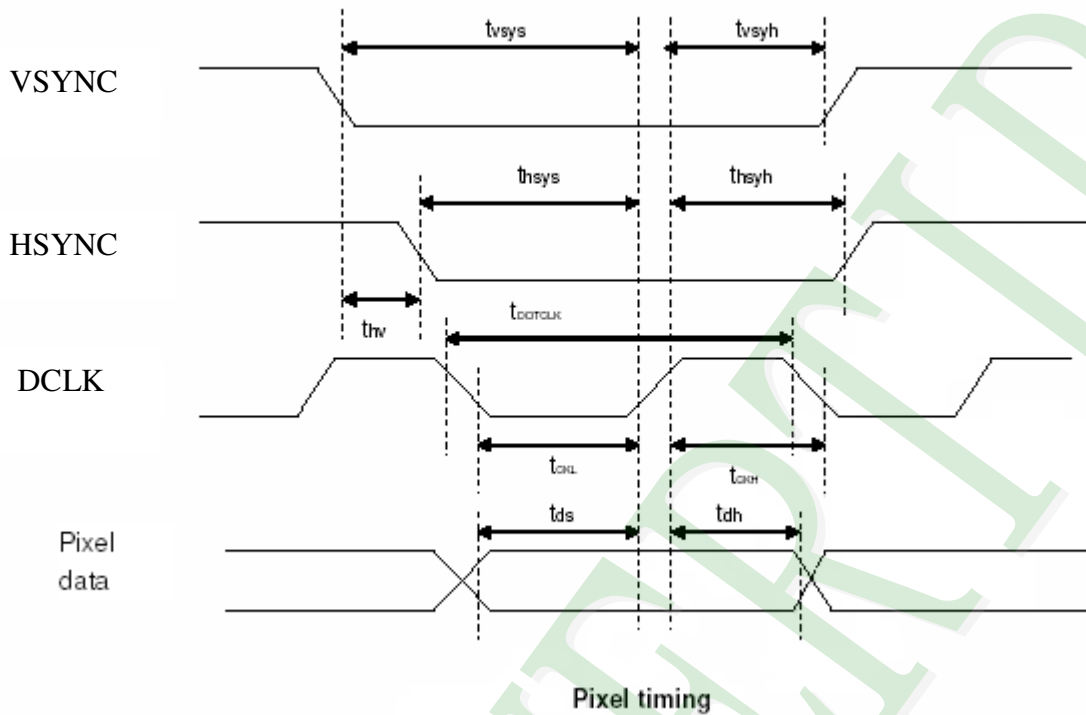

Characteristics	Symbol	Min.		Typ.		Max.		Unit
		24-bit	8-bit	24-bit	8-bit	24-bit	8-bit	
DCLK Frequency	DCLK	-	-	6.5	19.5	10	30	MHz
DCLK Period	DCLK	100	33.3	154	51.3	-	-	ns
Vertical Sync Setup Time	tvsys	20	10	-	-	-	-	ns
Vertical Sync Hold Time	tvsyh	20	10	-	-	-	-	ns
Horizontal Sync Setup Time	thsys	20	10	-	-	-	-	ns
Horizontal Sync Hold Time	thsyh	20	10	-	-	-	-	ns
Phase difference of Sync Signal Falling Edge	thv	1		-		240		tDOTCLK
DCLK Low Period	tCKL	50	15	-	-	-	-	ns
DCLK High Period	tCKH	50	15	-	-	-	-	ns
Data Setup Time	tds	12	10	-	-	-	-	ns
Data hold Time	tdh	12	10	-	-	-	-	ns
Reset pulse width	tRES	10		-		-		μs

Note: External clock source must be provided to DCLK pin of HX8238-D. The driver will not operate if absent of the clocking signal.

Note : The interface of this module can drive by digital 24-bit data.

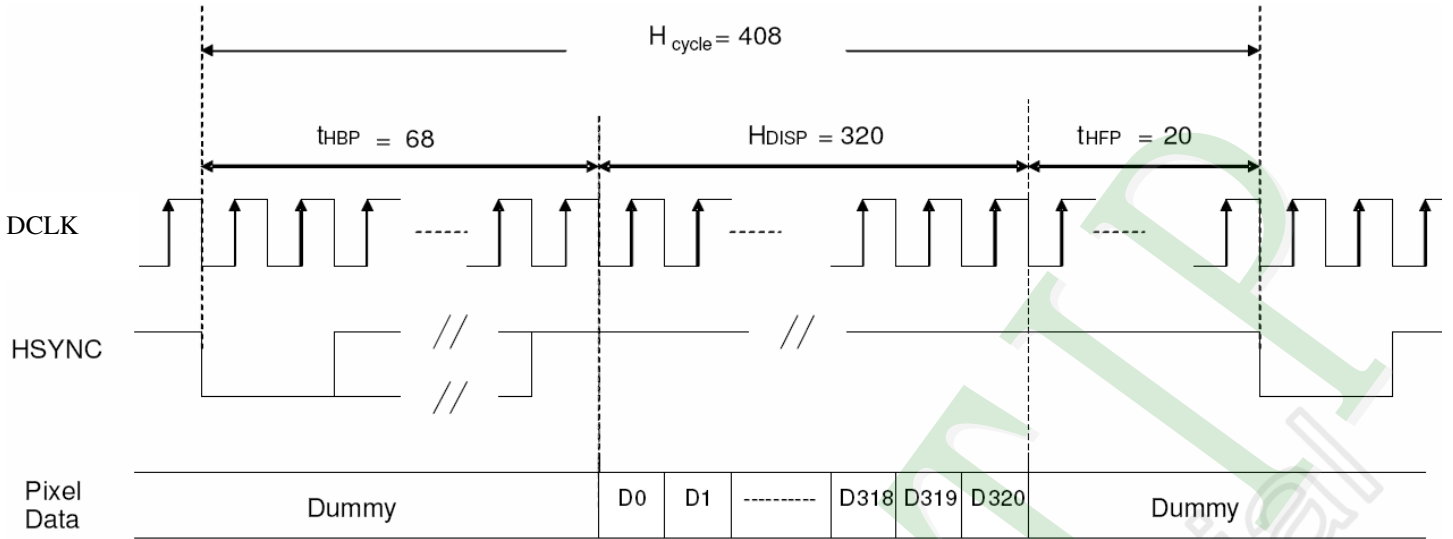

a) Horizontal Data Transaction Timing

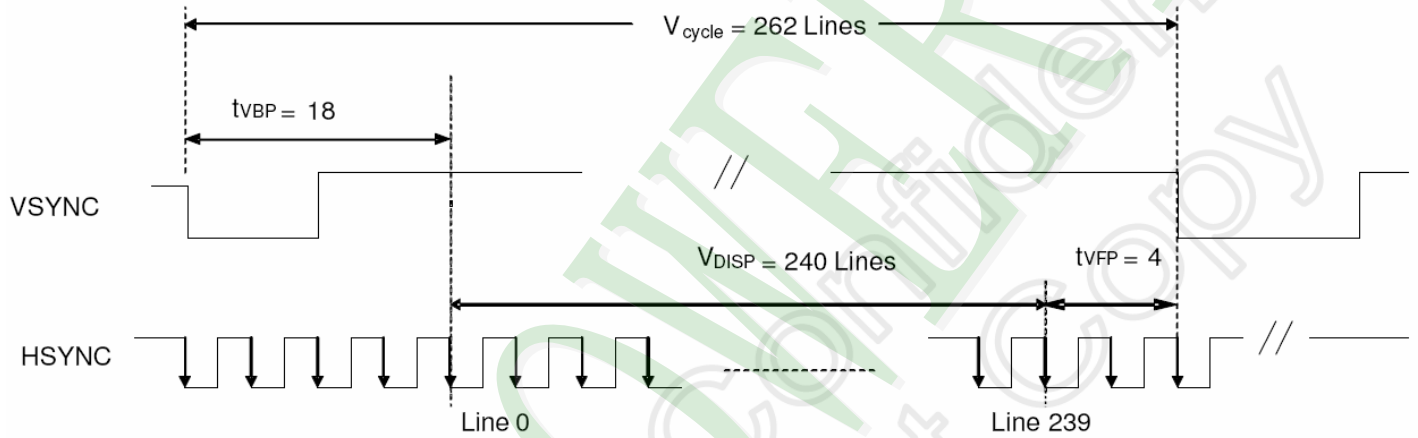

b) Vertical Data Transaction Timing

Data transaction timing in parallel RGB(24 bit)interface (SYNC mode)

3. QUALITY ASSURANCE SYSTEM

3.1 Quality Assurance Flow Chart

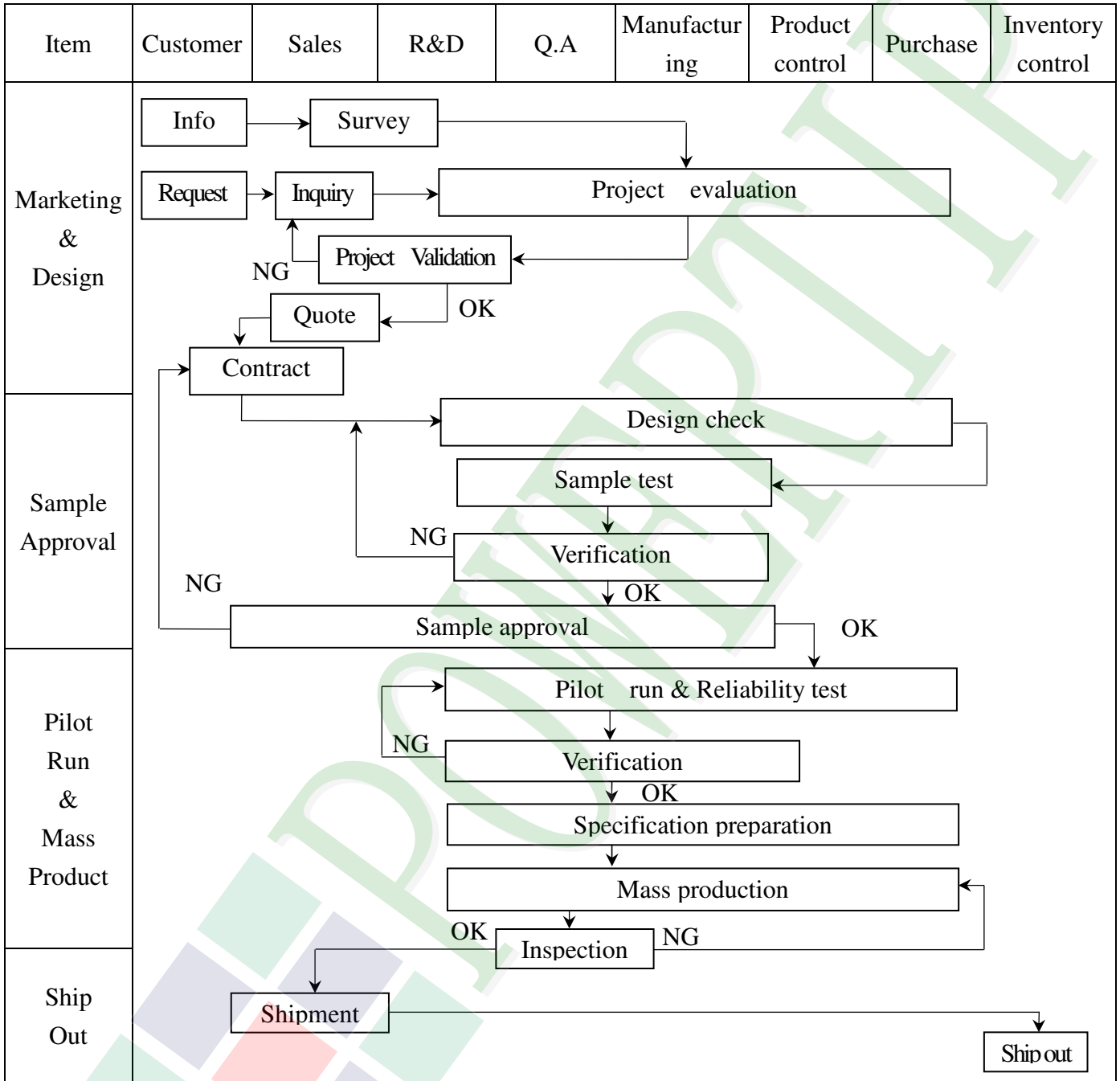

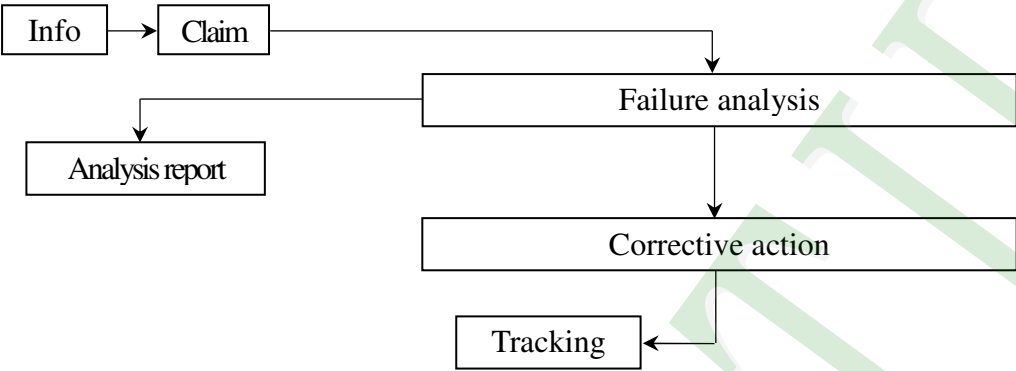
Item	Customer	Sales	R&D	Q.A	Manufacturing	Product control	Purchase	Inventory control
Sales Service	 <pre> graph TD Info[Info] --> Claim[Claim] Claim --> Failure[Failure analysis] Failure --> Report[Analysis report] Failure --> Action[Corrective action] Action --> Tracking[Tracking] </pre>							
Q.A Activity	1. ISO 9001 Maintenance Activities 3. Equipment calibration 5. Standardization Management				2. Process improvement proposal 4. Education And Training Activities			

3.2. Inspection Specification

- ◆Scope : The document shall be applied to TFT-LCD Module for PH320240T023-I02Q (Ver.01).
- ◆Inspection Standard : MIL-STD-105E Table Normal Inspection Single Sampling Level II.
- ◆Equipment : Gauge 、 MIL-STD 、 Powertip Tester 、 Sample
- ◆Defect Level : Major Defect AQL : 0.4 ; Minor Defect AQL : 1.5
- ◆OUT Going Defect Level : Sampling.
- ◆Standard of the product appearance test :

a. Manner of appearance test :

- (1). The test best be under 20W×2 fluorescent light , and distance of view must be at 30 cm.
- (2). The test direction is base on about around 45° of vertical line.

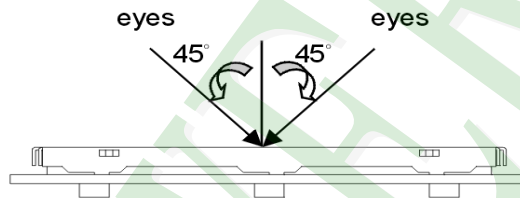

(3). Definition of area.

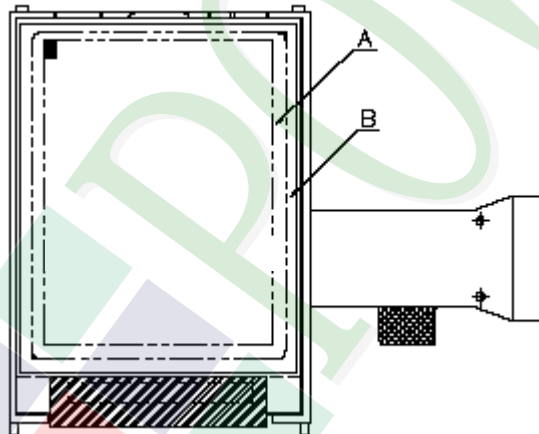

A area : viewing area

B area : Outside of viewing area

(4). Standard of inspection : (Unit : mm)

◆Specification For PH320240T023-I02Q :

(Ver.01)

NO	Item	Criterion	Level												
01	Product condition	1. 1 The part number is inconsistent with work order of production.	Major												
		1. 2 Mixed product types.	Major												
		1. 3 Assembled in inverse direction.	Major												
02	Quantity	2. 1 The quantity is inconsistent with work order of production.	Major												
03	Outline dimension	3. 1 Product dimension and structure must conform to structure diagram.	Major												
04	Electrical Testing	4. 1 Missing line character and icon.	Major												
		4. 2 No function or no display.	Major												
		4. 3 Display malfunction.	Major												
		4. 4 LCD viewing angle defect.	Major												
		4. 5 Current consumption exceeds product specifications.	Major												
05	Dot defect (Bright dot , Dark dot) On -display	<table border="1" data-bbox="560 1189 1273 1570"> <thead> <tr> <th colspan="2">Item</th> <th>Acceptance (Q'ty)</th> </tr> </thead> <tbody> <tr> <td rowspan="4">Dot Defect</td> <td>Bright Dot</td> <td>≤ 2</td> </tr> <tr> <td>Dark Dot</td> <td>≤ 1</td> </tr> <tr> <td>Joint Dot</td> <td>≤ 1</td> </tr> <tr> <td>Total</td> <td>≤ 3</td> </tr> </tbody> </table> <p>5. 1 Inspection pattern : full white , full black , Red , Green and blue screens. 5. 2 It is defined as dot defect if defect area $> 1/2$ dot. 5. 3 The distance between two dot defect ≥ 5 mm.</p>	Item		Acceptance (Q'ty)	Dot Defect	Bright Dot	≤ 2	Dark Dot	≤ 1	Joint Dot	≤ 1	Total	≤ 3	Minor
Item		Acceptance (Q'ty)													
Dot Defect	Bright Dot	≤ 2													
	Dark Dot	≤ 1													
	Joint Dot	≤ 1													
	Total	≤ 3													

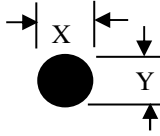
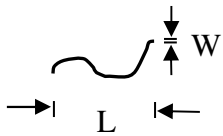
NO	Item	Criterion	Level																																							
06	<p>Black or white dot、scratch、contamination</p> <p>Round type</p>  <p>$\Phi = (x + y) / 2$</p> <p>Line type</p> 	<p>6. 1 Round type (Non-display or display) :</p> <table border="1" data-bbox="529 439 1308 855"> <thead> <tr> <th rowspan="2">Dimension (diameter : Φ)</th> <th colspan="2">Acceptance (Q'ty)</th> </tr> <tr> <th>A area</th> <th>B area</th> </tr> </thead> <tbody> <tr> <td>$\Phi \leq 0.20$</td> <td colspan="2">Ignore</td> </tr> <tr> <td>$0.20 < \Phi \leq 0.30$</td> <td>2</td> <td rowspan="2">Ignore</td> </tr> <tr> <td>$\Phi > 0.30$</td> <td>0</td> </tr> <tr> <td>Total</td> <td colspan="2">2</td> </tr> </tbody> </table> <p>6. 2 Line type(Non-display or display) :</p> <table border="1" data-bbox="504 974 1337 1442"> <thead> <tr> <th rowspan="2">Length (L)</th> <th rowspan="2">Width (W)</th> <th colspan="2">Acceptance (Q'ty)</th> </tr> <tr> <th>A area</th> <th>B area</th> </tr> </thead> <tbody> <tr> <td>---</td> <td>$W \leq 0.03$</td> <td>Ignore</td> <td rowspan="4">Ignore</td> </tr> <tr> <td>$L \leq 10.0$</td> <td>$0.03 < W \leq 0.05$</td> <td>4</td> </tr> <tr> <td>$L \leq 5.0$</td> <td>$0.05 < W \leq 0.10$</td> <td>2</td> </tr> <tr> <td>---</td> <td>$W > 0.10$</td> <td>As round type</td> </tr> <tr> <td colspan="2">Total</td> <td colspan="2">5</td> </tr> </tbody> </table>	Dimension (diameter : Φ)	Acceptance (Q'ty)		A area	B area	$\Phi \leq 0.20$	Ignore		$0.20 < \Phi \leq 0.30$	2	Ignore	$\Phi > 0.30$	0	Total	2		Length (L)	Width (W)	Acceptance (Q'ty)		A area	B area	---	$W \leq 0.03$	Ignore	Ignore	$L \leq 10.0$	$0.03 < W \leq 0.05$	4	$L \leq 5.0$	$0.05 < W \leq 0.10$	2	---	$W > 0.10$	As round type	Total		5		Minor
Dimension (diameter : Φ)	Acceptance (Q'ty)																																									
	A area	B area																																								
$\Phi \leq 0.20$	Ignore																																									
$0.20 < \Phi \leq 0.30$	2	Ignore																																								
$\Phi > 0.30$	0																																									
Total	2																																									
Length (L)	Width (W)	Acceptance (Q'ty)																																								
		A area	B area																																							
---	$W \leq 0.03$	Ignore	Ignore																																							
$L \leq 10.0$	$0.03 < W \leq 0.05$	4																																								
$L \leq 5.0$	$0.05 < W \leq 0.10$	2																																								
---	$W > 0.10$	As round type																																								
Total		5																																								
07	<p>Polarizer Bubble</p>	<table border="1" data-bbox="496 1509 1345 1933"> <thead> <tr> <th rowspan="2">Dimension (diameter : Φ)</th> <th colspan="2">Acceptance (Q'ty)</th> </tr> <tr> <th>A area</th> <th>B area</th> </tr> </thead> <tbody> <tr> <td>$\Phi \leq 0.25$</td> <td colspan="2">Ignore</td> </tr> <tr> <td>$0.25 < \Phi \leq 0.50$</td> <td>4</td> <td rowspan="3">Ignore</td> </tr> <tr> <td>$0.50 < \Phi \leq 0.80$</td> <td>1</td> </tr> <tr> <td>$\Phi > 0.80$</td> <td>0</td> </tr> <tr> <td>Total</td> <td colspan="2">5</td> </tr> </tbody> </table>	Dimension (diameter : Φ)	Acceptance (Q'ty)		A area	B area	$\Phi \leq 0.25$	Ignore		$0.25 < \Phi \leq 0.50$	4	Ignore	$0.50 < \Phi \leq 0.80$	1	$\Phi > 0.80$	0	Total	5		Minor																					
Dimension (diameter : Φ)	Acceptance (Q'ty)																																									
	A area	B area																																								
$\Phi \leq 0.25$	Ignore																																									
$0.25 < \Phi \leq 0.50$	4	Ignore																																								
$0.50 < \Phi \leq 0.80$	1																																									
$\Phi > 0.80$	0																																									
Total	5																																									

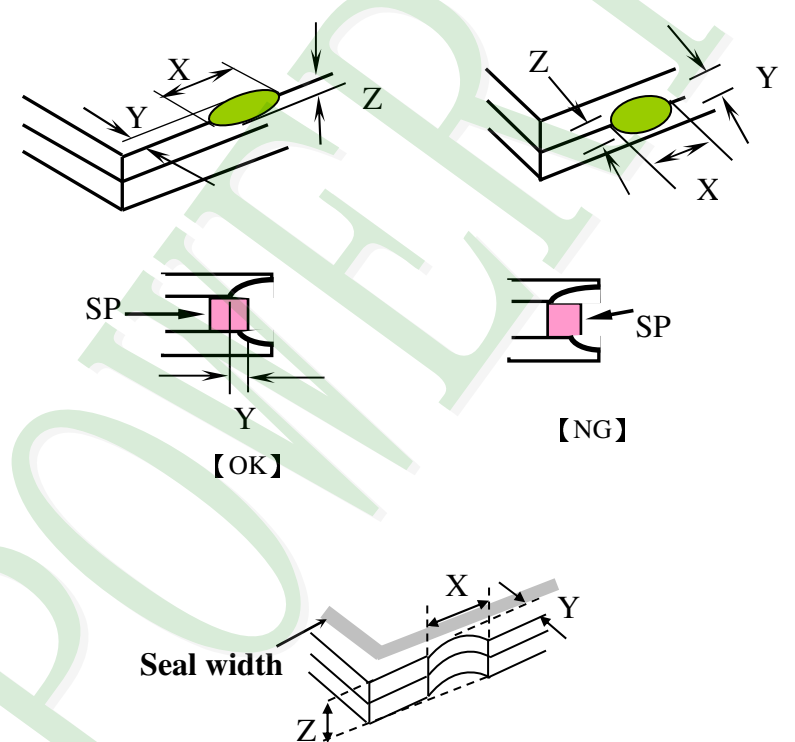
NO	Item	Criterion	Level						
08	The crack of glass	<p>Symbols :</p> <p>X : The length of crack Z : The thickness of crack t : The thickness of glass</p> <p>Y : The width of crack. W : terminal length a : LCD side length</p>	Minor						
		<p>8.1 General glass chip :</p> <p>8.1.1 Chip on panel surface and crack between panels:</p>  <table border="1" data-bbox="539 1585 1353 1883"> <thead> <tr> <th>X</th> <th>Y</th> <th>Z</th> </tr> </thead> <tbody> <tr> <td>$\leq a$</td> <td>Crack can't enter viewing area</td> <td>$\leq 1/2 t$</td> </tr> <tr> <td>$\leq a$</td> <td>Crack can't exceed the half of SP width.</td> <td>$1/2 t < Z \leq 2 t$</td> </tr> </tbody> </table>		X	Y	Z	$\leq a$	Crack can't enter viewing area	$\leq 1/2 t$
X	Y	Z							
$\leq a$	Crack can't enter viewing area	$\leq 1/2 t$							
$\leq a$	Crack can't exceed the half of SP width.	$1/2 t < Z \leq 2 t$							

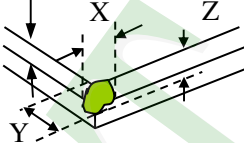
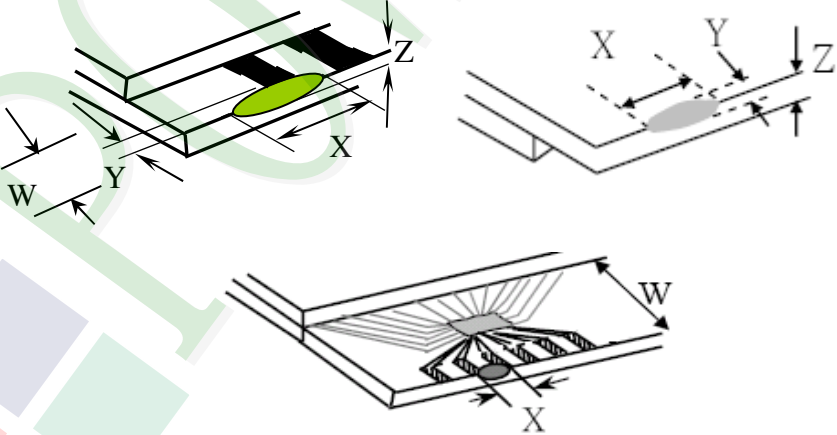
NO	Item	Criterion	Level										
08	The crack of glass	<p>Symbols :</p> <p>X : The length of crack Z : The thickness of crack t : The thickness of glass</p> <p>Y : The width of crack. W : terminal length a : LCD side length</p> <hr/> <p>8.1.2 Corner crack :</p>  <table border="1" data-bbox="520 779 1337 1070"> <thead> <tr> <th>X</th> <th>Y</th> <th>Z</th> </tr> </thead> <tbody> <tr> <td>$\leq 1/5 a$</td> <td>Crack can't enter viewing area</td> <td>$Z \leq 1/2 t$</td> </tr> <tr> <td>$\leq 1/5 a$</td> <td>Crack can't exceed the half of SP width.</td> <td>$1/2 t < Z \leq 2 t$</td> </tr> </tbody> </table>	X	Y	Z	$\leq 1/5 a$	Crack can't enter viewing area	$Z \leq 1/2 t$	$\leq 1/5 a$	Crack can't exceed the half of SP width.	$1/2 t < Z \leq 2 t$		
		X	Y	Z									
$\leq 1/5 a$	Crack can't enter viewing area	$Z \leq 1/2 t$											
$\leq 1/5 a$	Crack can't exceed the half of SP width.	$1/2 t < Z \leq 2 t$											
<p>8.2 Protrusion over terminal :</p> <p>8.2.1 Chip on electrode pad :</p>  <table border="1" data-bbox="560 1711 1347 1883"> <thead> <tr> <th></th> <th>X</th> <th>Y</th> <th>Z</th> </tr> </thead> <tbody> <tr> <td>Front</td> <td>$\leq a$</td> <td>$\leq 1/2 W$</td> <td>$\leq t$</td> </tr> <tr> <td>Back</td> <td>$\leq a$</td> <td>$\leq W$</td> <td>$\leq 1/2 t$</td> </tr> </tbody> </table>		X	Y	Z	Front	$\leq a$	$\leq 1/2 W$	$\leq t$	Back	$\leq a$	$\leq W$	$\leq 1/2 t$	Minor
	X	Y	Z										
Front	$\leq a$	$\leq 1/2 W$	$\leq t$										
Back	$\leq a$	$\leq W$	$\leq 1/2 t$										

◆Specification For PH320240T023-I02Q :

(Ver.01)

NO	Item	Criterion	Level
09	Backlight elements	9. 1 Backlight can't work normally.	Major
		9. 2 Backlight doesn't light or color is wrong.	Major
		9. 3 Illumination source flickers when lit.	Major
10	General appearance	10. 1 Pin type 、 quantity 、 dimension must match type in structure diagram.	Major
		10. 2 No short circuits in components on PCB or FPC .	Major
		10. 3 Parts on PCB or FPC must be the same as on the production characteristic chart .There should be no wrong parts , missing parts or excess parts.	Major
		10. 4 Product packaging must the same as specified on packaging specification sheet.	Minor
		10. 5 The folding and peeled off in polarizer are not acceptable.	Minor
		10. 6 The PCB or FPC between B/L assembled distance(PCB or FPC) is ≤ 1.5 mm.	Minor

5. PRECAUTION RELATING PRODUCT HANDLING

5.1 SAFETY

- 5.1.1 If the LCD panel breaks , be careful not to get the liquid crystal to touch your skin.
- 5.1.2 If the liquid crystal touches your skin or clothes , please wash it off immediately by using soap and water.

5.2 HANDLING

- 5.2.1 Avoid any strong mechanical shock which can break the glass.
- 5.2.2 Avoid static electricity which can damage the CMOS LSI—When working with the module , be sure to ground your body and any electrical equipment you may be using.
- 5.2.3 Do not remove the panel or frame from the module.
- 5.2.4 The polarizing plate of the display is very fragile. So , please handle it very carefully, do not touch , push or rub the exposed polarizing with anything harder than an HB pencil lead (glass , tweezers , etc.)
- 5.2.5 Do not wipe the polarizing plate with a dry cloth , as it may easily scratch the surface of plate.
- 5.2.6 Do not touch the display area with bare hands , this will stain the display area.
- 5.2.7 Do not use ketonics solvent & aromatic solvent. Use with a soft cloth soaked with a cleaning naphtha solvent.
- 5.2.8 To control temperature and time of soldering is $320 \pm 10^{\circ}\text{C}$ and 3-5 sec.
- 5.2.9 To avoid liquid (include organic solvent) stained on LCM

5.3 STORAGE

- 5.3.1 Store the panel or module in a dark place where the temperature is $25^{\circ}\text{C} \pm 5^{\circ}\text{C}$ and the humidity is below 65% RH.
- 5.3.2 Do not place the module near organics solvents or corrosive gases.
- 5.3.3 Do not crush , shake , or jolt the module.

5.4 TERMS OF WARRANTY

- 5.4.1 Applicable warrant period
The period is within thirteen months since the date of shipping out under normal using and storage conditions.
- 5.4.2 Unaccepted responsibility
This product has been manufactured to your company's specification as a part for use in your company's general electronic products. It is guaranteed to perform according to delivery specifications. For any other use apart from general electronic equipment, we cannot take responsibility if the product is used in nuclear power control equipment, aerospace equipment , fire and security systems or any other applications in which there is a direct risk to human life and where extremely high levels of reliability are required.

A B C D E F G H

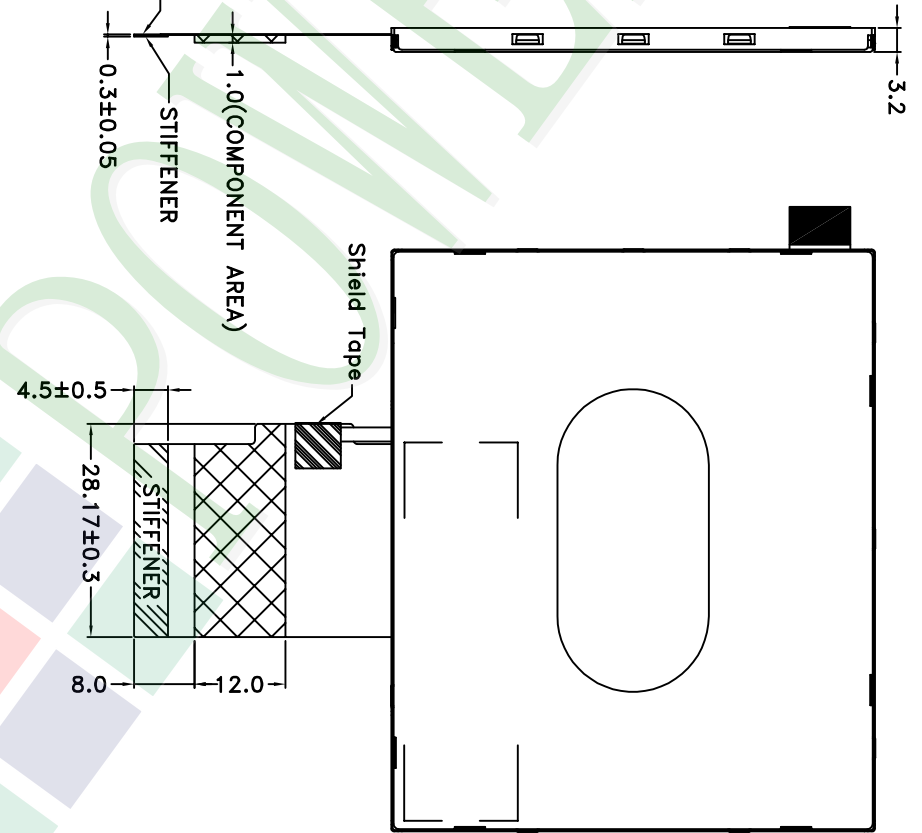
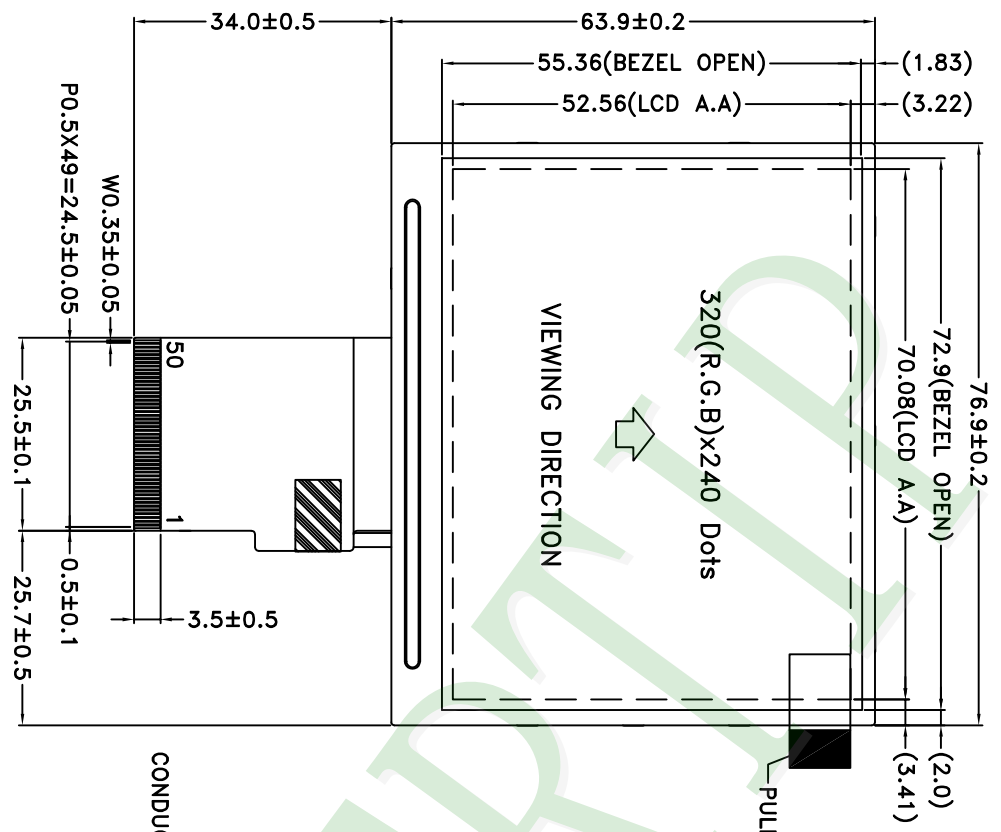

NOTES:
 1. LCD TYPE: a-SI TFT
 2. LCD DISPLAY: POSITIVE / TRANSMISSIVE
 3. The tolerance unless classified $\pm 0.2\text{mm}$
 4. FPC Connector: Kyocera 08 6282 050 340 829+ or EQUIVALENT

007					
006					
005					
004					
003					
002	MODIFY NOTE	Stone	2014/03/28		
001	NEW DRAWING	Stone	2012/12/07		
REV	REV BY	REVISER	DATE		

PART NO:		PH320240T-023-102Q
DRAWING NAME:		LMD-PH320240T-023-102Q
TITLE:		LCD MODULE DRAWING

Design		Stone	Surface		Precision Level
Check	Sam	Unit	Material	Thickness	
Approve	Oliver	Scale	FIT	Quantity	
		Page	1/2		

久正光電股份有限公司
 POWER TIP TECHNOLOGY CORPORATION

Magnification		(3)	Resolution		Precision Level
Unit	MM	1 ~ 4	Material	Thickness	
Scale	FIT	4 ~ 16			
Page	1/2	16 ~ 63			
		63 ~ 250			
		250 ~ 1000			

LCM包裝規格書

LCM Packaging Specifications

(For Tray)

Approve	Check	Contact
Oliver	Sam	Stone

Documents NO. PKG-PH320240T-023-I02Q

1. 包裝材料規格表 (Packaging Material) : (per carton)

No.	Item	Model	Dimensions (mm)	1Pcs Weight	Quantity	Total Weight
1	成品 (LCM)	PH320240T-023-I02Q	76.9 X 63.9	0.032	288	9.216
2	多層薄膜(1)POF	OTFILM0BA03ABA	19"X350X0.015	—	6	—
3	TRAY 盤 (2)Tray	TY32024001TZBA	352 X 260 X 10.8	0.1	54	5.4
4	內盒(3)Product Box	BX36627063ABBA	393 X 274 X 68	0.2692	6	1.6152
5	保利龍板(4)Polylon board	OTPLB00PL08ABA	550 X 393 X 20	0.0284	2	0.0568
6	外紙箱(5)Carton	BX57041027CCBA	570 X 410 X 265	1.4208	1	1.4208
7						
8						
9						

2. 一整箱總重量 (Total LCD Weight in carton) : 17.71 Kg±10%

3. 單箱數量規格表 (Packaging Specifications and Quantity) :

(1) LCM quantity per box : no per tray	6	x no of tray	8	=	48
(2) Total LCM quantity in carton : quantity per box	48	x no of boxes	6	=	288

Use empty tray
空盤

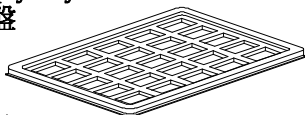

+

(1) 多層薄膜
POF

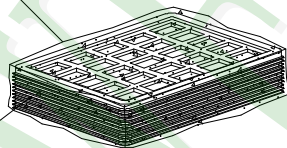

(4) 保利龍板
Polylon board

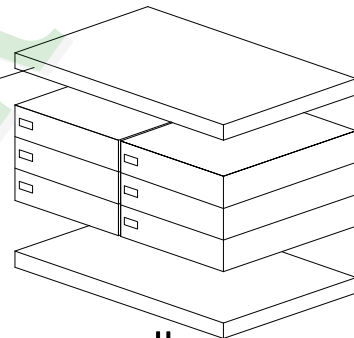

Put products into the tray

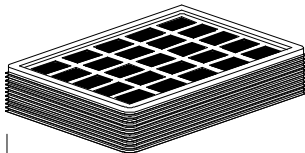

(2) TRAY 盤
Tray

↓

Tray stacking

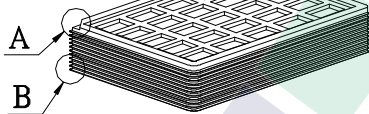

(3) 內盒
Product Box

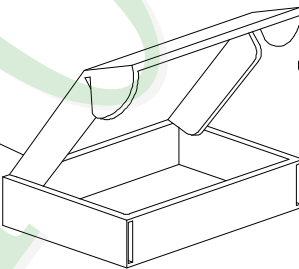

(5) 外紙箱
Carton

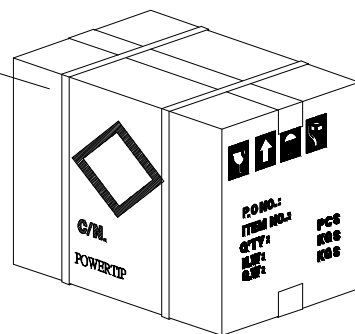

特 記 事 項 (REMARK)

4. Label Specifications :

TYPE			
ID.NO		S/O	
Q'TY	Pcs	Date	
Lot.NO			
Note			

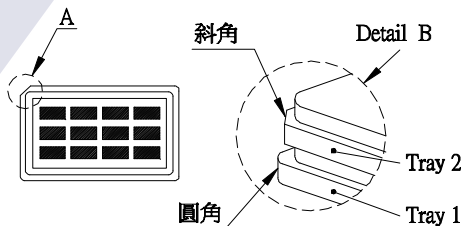

5. TRAY盤相疊時,需旋轉180度,請詳見B視圖
Rotate tray 180 degrees and place on top of stack.
Check the tray stack using Fig. B.

參照"成品包裝點檢作業標準書"內容

X-ON Electronics

Largest Supplier of Electrical and Electronic Components

Click to view similar products for [TFT Displays & Accessories category](#):

Click to view products by [Powertip manufacturer](#):

Other Similar products are found below :

[OAI-80038AA-2013-A](#) [HDA430T-3G1H](#) [T-51750GD065J-LW-BGN](#) [NB-ATT01](#) [NL8060BC26-35C](#) [TCG104SVLQAPNN-AN20](#) [OAI-80038AA-2008-A](#) [315-U004B15300](#) [EIC-LCD-1080P](#) [NL10276BC20-18C](#) [NLB121XG01L-01](#) [DEM 128160D](#) [TMH-PW-N](#) [RFE43BU-AIW-DNG](#) [RFC350X-AWW-DNG](#) [RFS390E-AWW-DNN](#) [DEM 480272G2](#) [VMX-PW-N \(A-TOUCH\)](#) [PH800480T013-ICA](#) [DEM 1024600N](#) [VMX-PW-N \(C-TOUCH\)](#) [DEM 1024600P](#) [VMH-PW-N \(C-TOUCH\)](#) [SM-RVT50HQHNWCA0](#) [DEM 240280A](#) [VMH-PW-N](#) [DEM 170320A](#) [VMH-PW-N](#) [PH240320T068-LAB08](#) [DEM 800480T1](#) [TMH-PW-N](#) [PH128128T041-LAA07](#) [DEM 800480Q4](#) [VMX-PW-N \(A-TOUCH\)](#) [PH480272T005-IAC02](#) [DEM 1024600P](#) [VMH-PW-N \(A-TOUCH\)](#) [DEM 800480T1](#) [TMH-PW-N \(C-TOUCH\)](#) [DEM 800480Q4](#) [VMX-PW-N](#) [DEM 800480T1](#) [TMH-PW-N \(A-TOUCH\)](#) [PH320240T-023-I02Q](#) [PH128800T004-ZZA01](#) [RFE430W-1YW-DBS](#) [DEM 1024600N](#) [VMX-PW-N \(A-TOUCH\)](#) [PH240320T074-ZAA01](#) [DEM 480480D](#) [VMX-PW-N \(C-TOUCH\)](#) [SM-RVT50HQSNWN00](#) [SM-RVT50HQHNWC00](#) [PH800480T033-ICB01](#) [RFE430W-AWW-DNN](#) [DEM 096096A](#) [VMH-PW-N](#) [RL0F00050000FGAAASA01](#) [PH320480T009-LAA01](#) [SM-RVT50HQSNWCA0](#) [SM-RVT50HQSNWC00-B](#) [PH320240T028-ZEA01](#) [RFE430W-1YW-DBN](#) [SM-RVT50HQLFWN00](#) [SM-RVT50HQHNWC00-B](#)