

SPECIFICATIONS

CUSTOMER	:	_____
SAMPLE CODE	:	SH800480T027-ZHA
MASS PRODUCTION CODE	:	PH800480T027-ZHA
SAMPLE VERSION	:	02
SPECIFICATIONS EDITION	:	008
DRAWING NO. (Ver.)	:	LMD-PH800480T027-ZHA (Ver.005)
PACKAGING NO. (Ver.)	:	PKG-PH800480T027-ZHA (Ver.002)

Customer Approved

Date: _____

Approved	Checked	Designer
陳彥良 Jimmy Chen	廖志豪 Rex Liao	張慶源 Yuan Chang

- Preliminary specification for design input
- Specification for sample approval

POWERTIP TECH. CORP.

Headquarters:

No.8, 6th Road, Taichung Industrial Park,
Taichung, Taiwan
台中市 407 工業區六路 8 號

TEL: 886-4-2355-8168
FAX: 886-4-2355-8166

E-mail: sales@powertip.com.tw
[Http://www.powertip.com.tw](http://www.powertip.com.tw)

History of Version

Date (mm / dd / yyyy)	Ver.	Edi.	Description	Page	Design by
06/06/2018	01	001	New Drawing.	-	Yuan
08/13/2018	01	002	Modify Mechanical Specifications Modify Optical Characteristics Modify Backlight Characteristics Modify Interface Pin Description Modify LCM Design	4 7 9 12 Appendix	Yuan
04/12/2019	01	003	First Sample Modify Optical Characteristics Modify Backlight Characteristics Modify Block Diagram Modify Interface Pin Description Modify BL FC design and FPC design	- 6 9 10 12 Appendix	Yuan
12/11/2019	01	004	Add Dimension and Black tape	Appendix	Yuan
02/24/2020	01	005	Modify LCD Type Add TOP and T _{ST} notes Modify Optical Characteristics Modify Block Diagram Modify Interface Pin Description Modify Timing Characteristics Modify Inspection Specification Modify PRECAUTION RELATING PRODUCT HANDLING	4 5 6 10 11~12 14~16 19~25 29	Yuan
04/14/2020	02	006	Second Sample	-	Yuan
07/21/2020	02	007	Modify Backlight Characteristics Modify Reliability Test Condition	9 25~26	Yuan
11/04/2020	02	008	Modify Backlight Characteristics	9	Yuan

Contents

1. SPECIFICATIONS

- 1.1 Features
- 1.2 Mechanical Specifications
- 1.3 Absolute Maximum Ratings
- 1.4 DC Electrical Characteristics
- 1.5 Optical Characteristics
- 1.6 Backlight Characteristics

2. MODULE STRUCTURE

- 2.1 Counter Drawing
- 2.2 Interface Pin Description
- 2.3 Timing Characteristics

3. QUALITY ASSURANCE SYSTEM

- 3.1 Quality Assurance Flow Chart
- 3.2 Inspection Specification

4. RELIABILITY TEST

- 4.1 Reliability Test Condition

5. PRECAUTION RELATING PRODUCT HANDLING

- 5.1 Safety
- 5.2 Handling
- 5.3 Storage
- 5.4 Terms of Warranty

Appendix :

- 1. LCM drawing
- 2. LCM Packaging Specifications

1. SPECIFICATIONS

1.1 Features

Item	Standard Value
Display Type	800 * (RGB) * 480
LCD Type	Full Viewing Angle , Normally Black , Transmissive type
Screen size(inch)	7.0 inch
Surface treatment	Hard Coating
Color configuration	RGB-stripe
Backlight Type	LED B/L
Weight	233.5g
Interface	24 Bits RGB Interface
ROHS	THIS PRODUCT CONFORMS THE ROHS OF PTC Detail information please refer website : http://www.powertip.com.tw/news_detail.php?Key=1&cID=1

1.2 Mechanical Specifications

Item	Standard Value	Unit
Outline Dimension	167.7(W) * 109.45 (L) * 19.8 (H)	mm

LCD panel

Item	Standard Value	Unit
Active Area	152.4 (W) * 91.44 (L)	mm

Note : For detailed information please refer to LCM drawing

1.3 Absolute Maximum Ratings

Module

Item	Symbol	Condition	Min.	Max.	Unit	Remark
Power Supply Voltage	V _{DD}	GND=0	3	3.6	V	-
Operating Temperature	T _{OP} (T _s)	Note (5)	-30	+85	°C	(1)(2)(3)(4)
Storage Temperature	T _{ST} (T _a)	Note (6)	-40	+90	°C	(1)(2)(3)(4)

Note (1) (a) 90 %RH Max. (T_a ≤ 40 °C).

(b) Wet-bulb temperature should be 39 °C Max. (T_a > 40 °C).

(c) No condensation.

Note (2) T_a = Ambient Temperature, T_p = Panel Surface Temperature.

Note (3) This rating applies to all parts of the module and should not be exceeded.

Note (4) If the product were used out of the operation and storage range, it will have quality issue.

Note (5) T_s is the temperature of panel's surface.

Note (6) T_a is the ambient temperature of samples.

1.4 DC Electrical Characteristics

Module

GND = 0V, T_a = 25°C

Item	Symbol	Min.	Typ.	Max.	Unit	Remark
Supply Voltage	V _{DD}	3.0	3.3	3.6	V	-
Input signal Voltage	V _{IH}	0.7V _{DD}	-	V _{DD}	V	
	V _{IL}	0	-	0.3V _{DD}		
Supply Current	I _{VDD}	-	180	220	mA	-

1.5 Optical Characteristics

TFT LCD Module

 $V_{DD} = 3.3 \text{ V}, T_a = 25^\circ\text{C}$

Item		Symbol	Condition	Min.	Typ.	Max.	unit	
Response time		Tr+Tf	$T_a = 25^\circ\text{C}$ $\theta X, \theta Y = 0^\circ$	-	30	45	ms	Note 2
Viewing angle	Top	$\theta Y+$	$CR \geq 10$	-	80	-	Deg.	Note 4
	Bottom	$\theta Y-$		-	80	-		
	Left	$\theta X-$		-	80	-		
	Right	$\theta X+$		-	80	-		
Contrast ratio		CR		600	800	-		Note 3
Color of CIE Coordinate (With B/L)	White	X	$T_a = 25^\circ\text{C}$ $\theta X, \theta Y = 0^\circ$	0.24	0.29	0.34	-	Note1
		Y		0.29	0.34	0.39		
	Red	X		0.61	0.66	0.71		
		Y		0.29	0.34	0.39		
	Green	X		0.25	0.30	0.35		
		Y		0.56	0.61	0.66		
	Blue	X		0.08	0.13	0.18		
		Y		0.01	0.06	0.11		
Average Brightness Pattern=white display (With B/L) *1		IV	IL = 180 mA	800	950	-	cd/m2	Note1
Uniformity (With B/L) *2		ΔB	IL = 180 mA	70	-	-	%	Note1

Note 1:

*1 : $\Delta B = B(\text{min}) / B(\text{max}) * 100\%$

*2 : Measurement Condition for Optical Characteristics:

- a : Environment: $25^{\circ}\text{C} \pm 5^{\circ}\text{C}$ / $60 \pm 20\% \text{R.H}$, no wind , dark room below 10 Lux at typical lamp current and typical operating frequency.
- b : Measurement Distance: $500 \pm 50 \text{ mm}$, ($\theta = 0^{\circ}$)
- c : Equipment: TOPCON BM-7 fast , (field 1°) , after 10 minutes operation.
- d : The uncertainty of the C.I.E coordinate measurement ± 0.01 , Average Brightness $\pm 4\%$

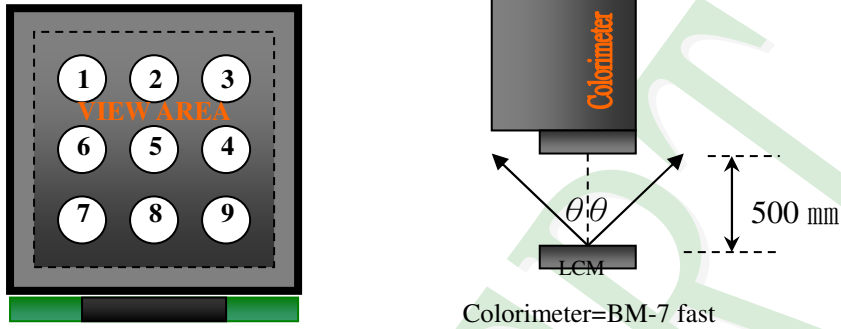

To be measured at the center area of panel with a viewing cone of 1° by Topcon luminance meter BM-7, after 10 minutes operation (module)

Note2: Definition of response time:

The output signals of photo detector are measured when the input signals are changed from "black" to "white"(falling time) and from "white" to "black"(rising time), respectively. The response time is defined as the time interval between the 10% and 90% of Amplitudes.

Refer to figure as below:

Normally White



Normally Black

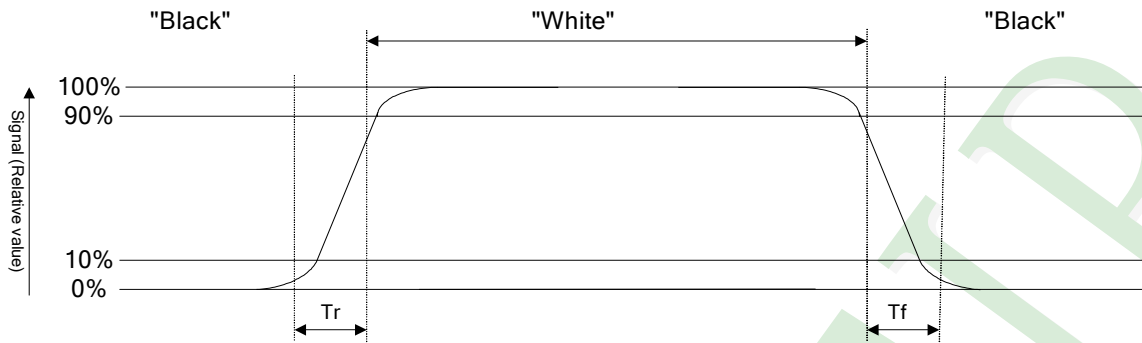

Note3: Definition of contrast ratio:

Contrast ratio is calculated with the following formula

$$\text{Contrast ratio (CR)} = \frac{\text{Photo detector output when LCD is at "White" state}}{\text{Photo detector output when LCD is at "Black" state}}$$

Note4: Definition of viewing angle:

Refer to figure as below:

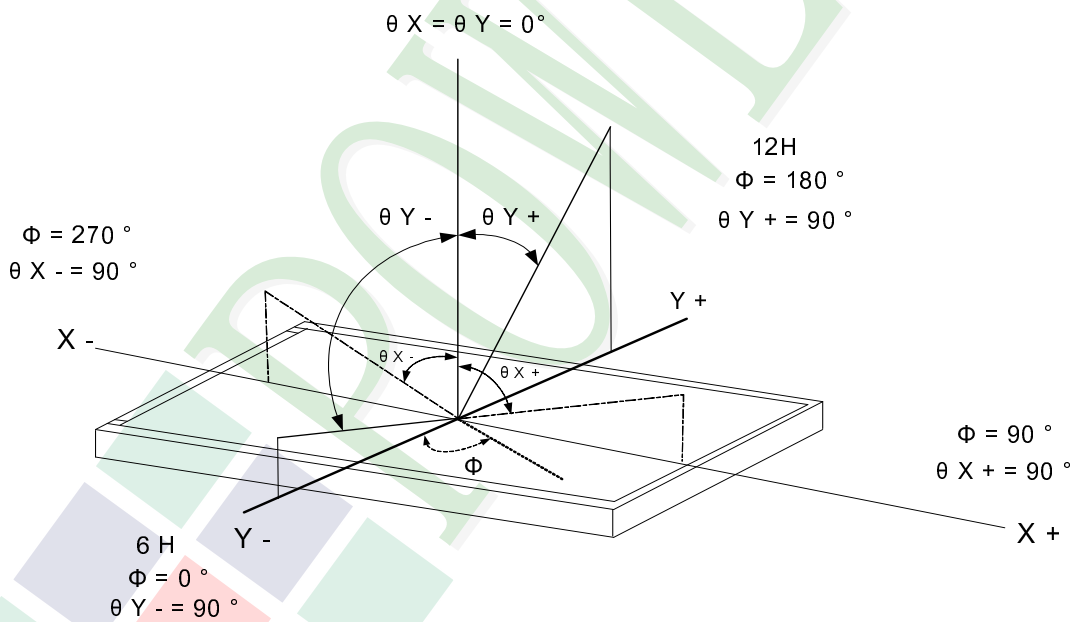

1.6 Backlight Characteristics

Maximum Ratings

Item	Symbol	Conditions	Min.	Max.	Unit
LED Forward Current	IF	Ta =25℃	-	180	mA
LED Reverse Voltage	VR	Ta =25℃	-	5	V
Power Dissipation	PD	Ta =25℃	-	4.464	W

Backlight Characteristics

Item	Symbol	Conditions	Min.	Typ.	Max.	Unit
Forward Voltage	VF	IF= 180 mA	22.4	24.0	24.8	V
Average Brightness (Without LCD)	IV		19000	22000	25000	cd/m ²
CIE Color Coordinate (Without LCD)	X		0.25	0.28	0.31	-
	Y		0.25	0.28	0.31	
Uniformity *1	△B		75	-	-	*2
Color		White				

*1 : This value will be changed while mass production.

*2 : $\Delta B = B(\text{min}) / B(\text{max})\%$
B/L Internal Circuit Diagram

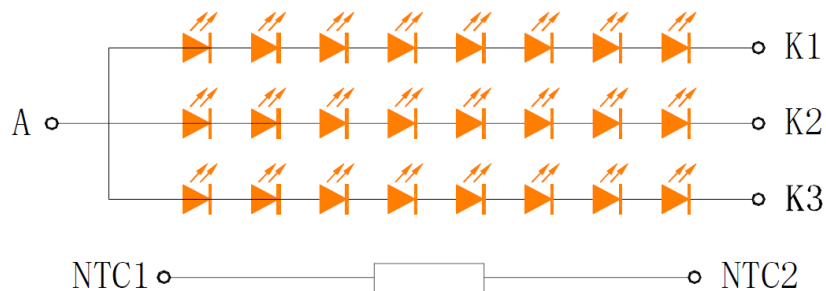

Other Description

Item	Conditions	Description
Life Time	Ta =25℃ IF= 180 mA	50000 hrs

2. MODULE STRUCTURE

2.1 Counter Drawing

2.1.1 LCM Mechanical Diagram

* See Appendix

2.1.2 Block Diagram

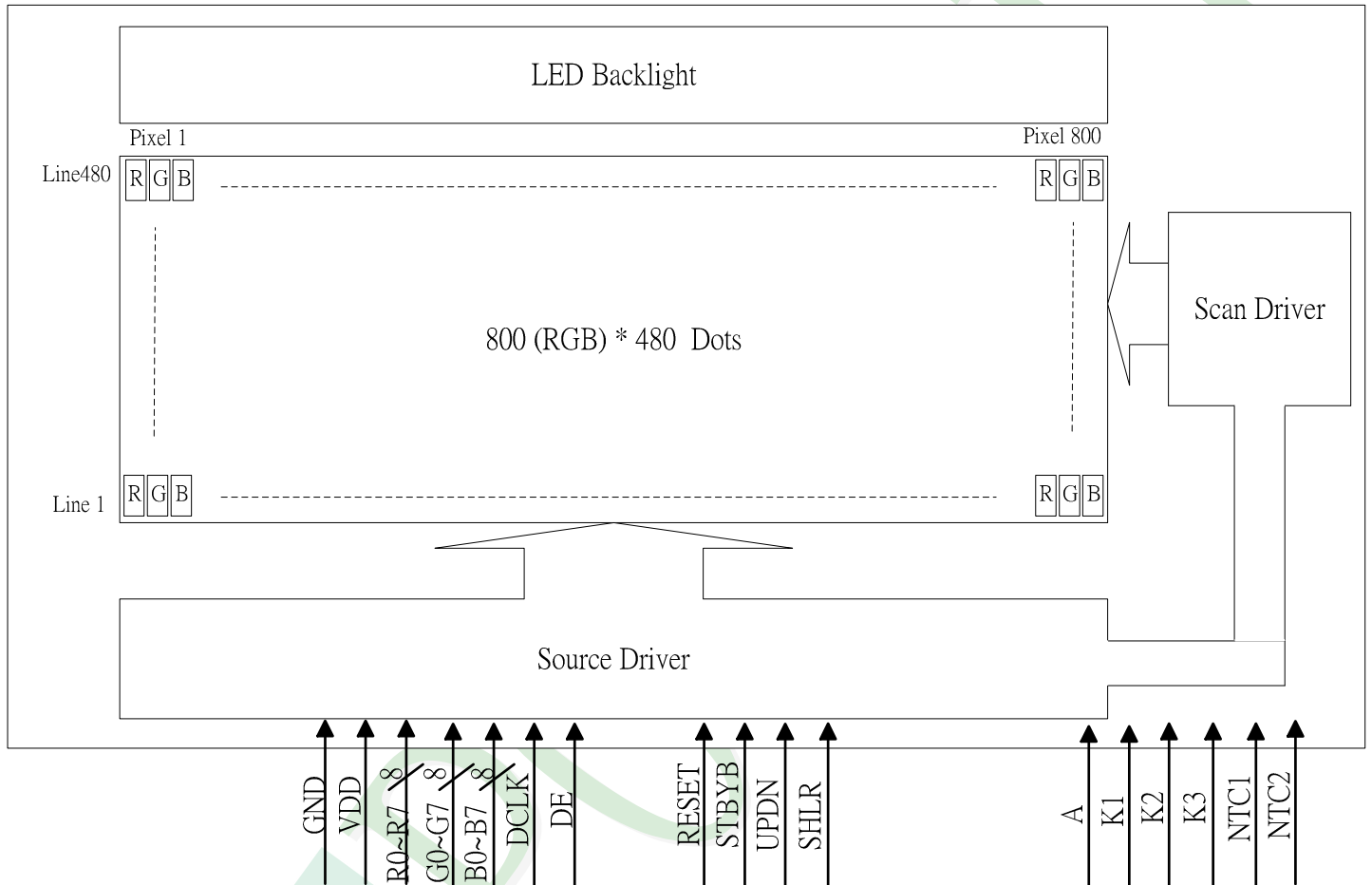

2.2 Interface Pin Description

TFT LCM Interface

Pin NO.	SYMBOL	DESCRIPTION
1	GND	Power ground.
2	NC	No Connection
3	V _{DD}	Power for Digital Circuit.
4	R0	Red Data(LSB).
5	R1	Red Data.
6	R2	Red Data.
7	R3	Red Data.
8	R4	Red Data.
9	R5	Red Data.
10	R6	Red Data.
11	R7	Red Data(MSB).
12	G0	Green Data(LSB).
13	G1	Green Data.
14	G2	Green Data.
15	G3	Green Data.
16	G4	Green Data.
17	G5	Green Data.
18	G6	Green Data.
19	G7	Green Data(MSB).
20	B0	Blue Data(LSB).
21	B1	Blue Data.
22	B2	Blue Data.
23	B3	Blue Data.
24	B4	Blue Data.
25	B5	Blue Data.
26	B6	Blue Data.
27	B7	Blue Data(MSB).
28	DCLK	Clock signal
29	DE	Data Input Enable.
30	V _{DD}	Power for Digital Circuit.
31	V _{DD}	Power for Digital Circuit.
32	NC	No Connection
33	RESET	Global reset pin.
34	STBYB	Standby mode
35	SHLR	Horizontal scan direction

Pin NO.	SYMBOL	DESCRIPTION
36	V _{DD}	Power for Digital Circuit.
37	UPDN	Vertical scan direction
38	GND	Power Ground
39	GND	Power Ground.
40	NC	No connection.
41	NC	No connection.
42	NC	No connection.
43	NC	No connection.
44	NC	No connection.
45	NC	No connection.
46	NC	No connection.
47	NC	No connection.
48	NC	No connection.
49	V _{DD}	Power for Digital Circuit.
50	NC	No connection.
51	GND	Power Ground.
52	GND	Power Ground.
53	GND	Power Ground.
54	V _{DD}	Power for Digital Circuit.
55	NC	No connection.
56	NC	No connection.
57	V _{DD}	Power for Digital Circuit.
58	NC	No connection.
59	GND	Power Ground.
60	NC	No connection.

FPC1 interface (LED Backlight)

Pin No.	Symbol	Function
1	A	LED Backlight anode input
2	K1	LED Backlight for cathode input
3	K2	LED Backlight for cathode input
4	K3	LED Backlight for cathode input
5	NTC1	Thermistor
6	NTC2	Thermistor

2.3 Timing Characteristics

2.3.1 POWER ON/OFF TIMING SEQUENCE

The recommended power on sequence should be: VDD _ RESET _ STBYB. To power off, reverse this sequence, or turn off all signals and power simultaneously.

Power on :

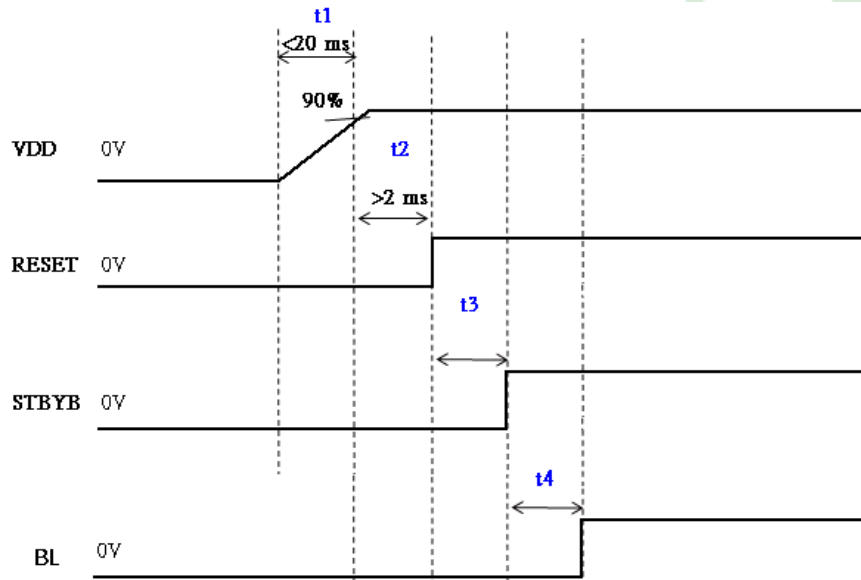

Power off :

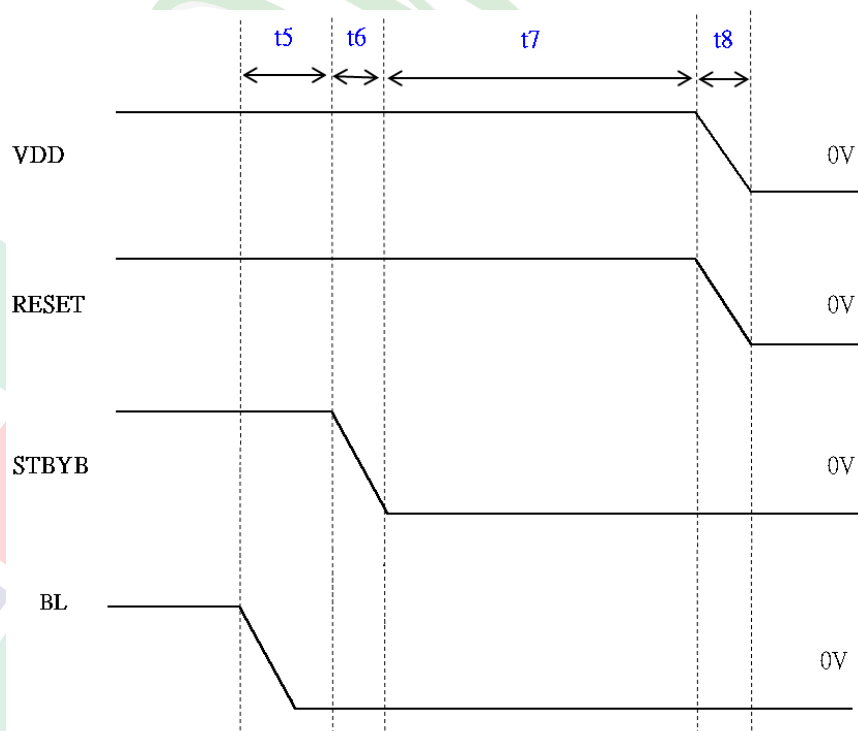

Power On/Off Timing

Symbol	SPEC.			Unit
	Min.	Typ.	Max.	
t1	0	5	20	ms
t2	2	3	5	ms
t3	0	5	10	ms
t4	170	200	234	ms
t5	17	34	51	ms
t6	0	2	5	ms
t7	150	167	184	ms
t8	0	2	5	ms

2.3.2 Data Input Format for TTL

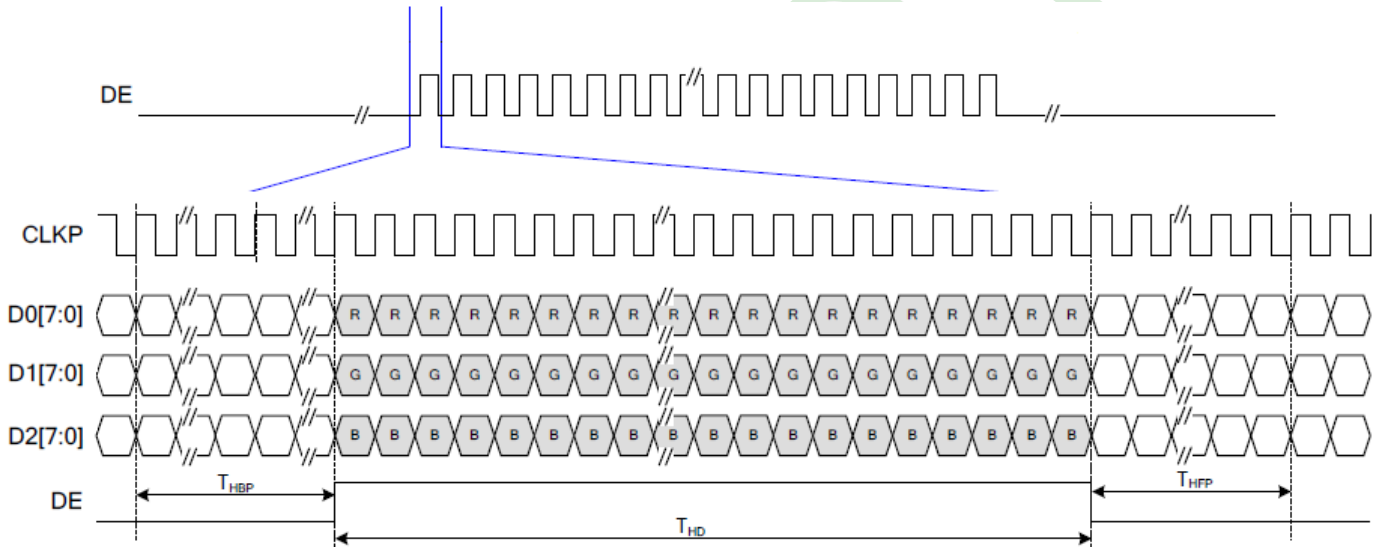

2.3.3 Input Timing

Only DE mode for 800x480

Parameter	Symbol	Min.	Typ.	Max.	Unit
CLK frequency	F_{CLK}	25.2	25.4	35.7	MHz
Horizontal display area	T_{HD}		800		CLK
HS period time	T_H	860	864	974	CLK
HS blanking	$T_{HFP} + T_{HBP}$	60	64	174	CLK
Vertical display area	T_{VD}		480		H
VS period time	T_V	488	490	611	H
VS blanking	$T_{VBP} + T_{VFP}$	8	10	131	H

2.3.4 AC Electrical Characteristics

Basic Input AC Characteristic :

(VDD= 3.0V to 3.6V, GND= 0V, Ta= +25°C)

Parameter	Symbol	Min.	Typ.	Max.	Unit	Conditions
VDD power source slew time	T_{POR}	-	-	20	ms	From 0V to 90% VDD
GRB active pulse width	T_{GRB}	1	-	-	ms	VDD = 3.3V
Power on reset voltage	V_{POR}	0	-	100	mV	

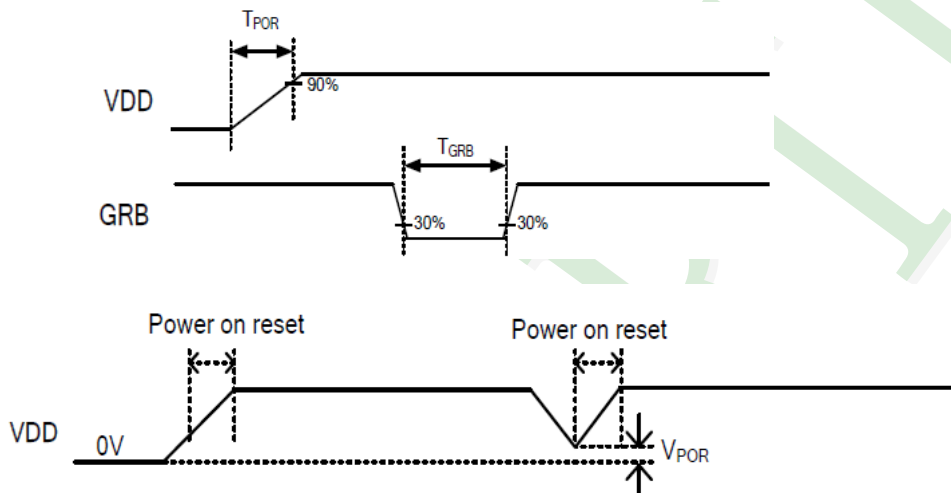

Power On Reset Chart

TTL-DE Interface AC Characteristic :

(VDD= 3.0V to 3.6V, GND= 0V, Ta= +25°C)

Parameter	Symbol	Min.	Typ.	Max.	Unit	Conditions
Clock Frequency	F_{CLK}	5	-	55	MHz	$T_{CLK} = 1/F_{CLK}$
CLK pulse width	T_{CW}	30% (*)	-	70%	T_{CLK}	(*) Over than $0.5/(F_{CLK})_{max}$.
Data setup time	T_{DSU}	6	-	-	ns	
Data hold time	T_{DHD}	6	-	-	ns	
DE setup time	T_{ESU}	6	-	-	ns	

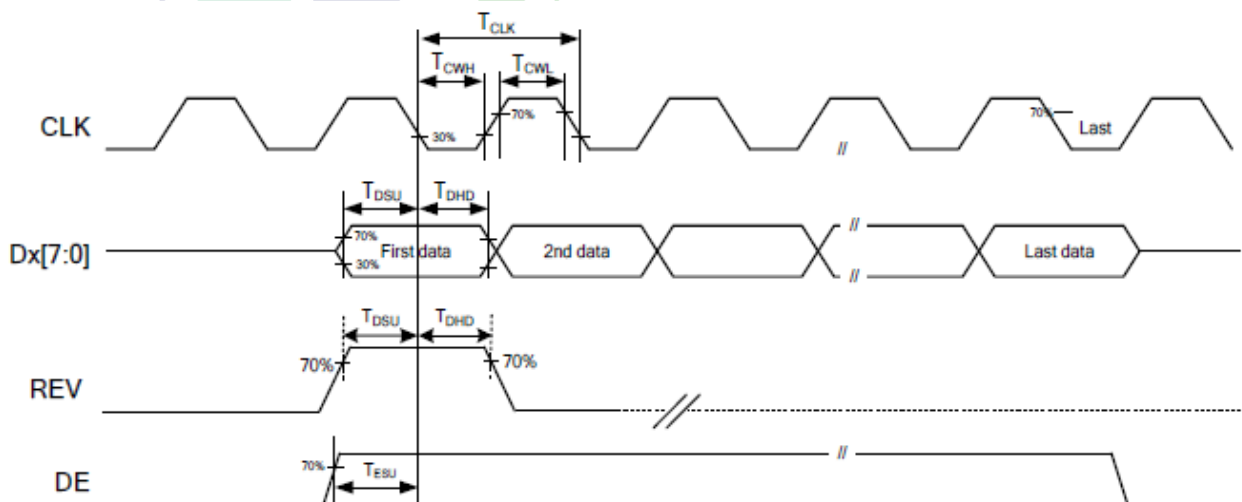

3. QUALITY ASSURANCE SYSTEM

3.1 Quality Assurance Flow Chart

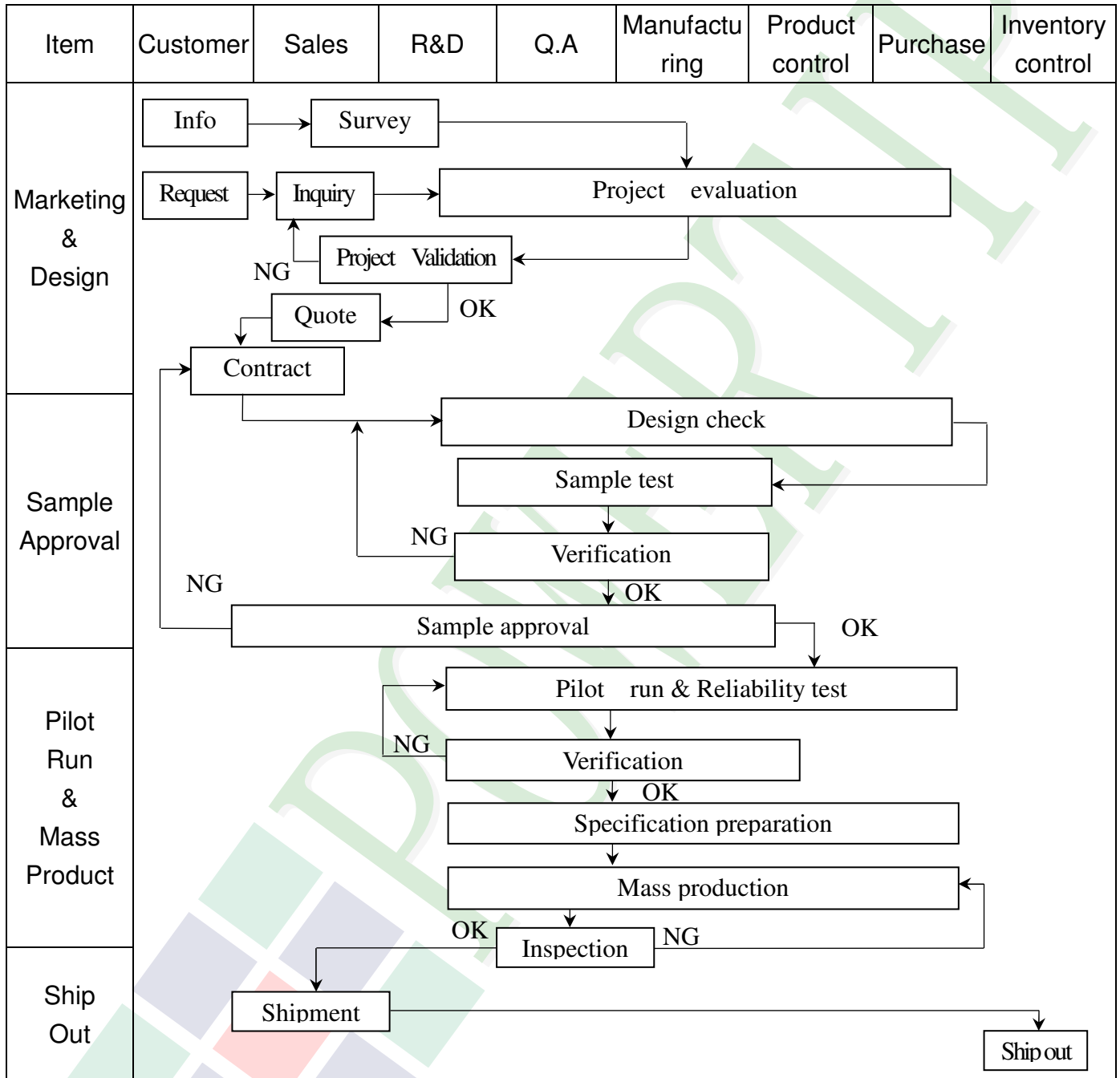

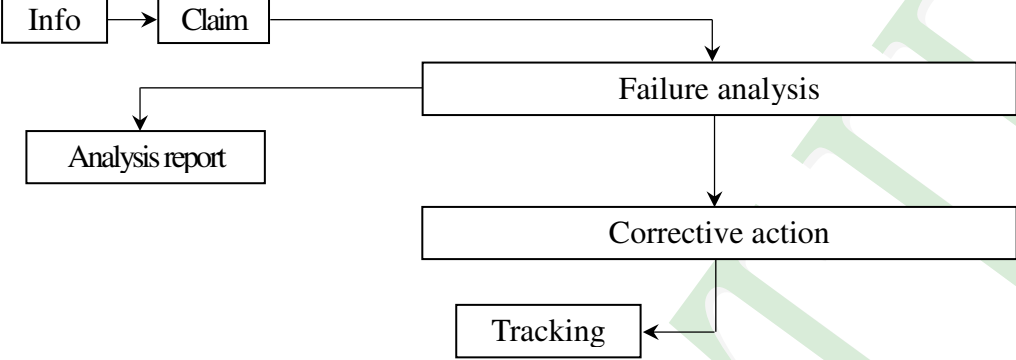
Item	Customer	Sales	R&D	Q.A	Manufacturing	Product control	Purchase	Inventory control
Sales Service	 <pre> graph TD Info[Info] --> Claim[Claim] Claim --> FA[Failure analysis] Claim --> AR[Analysis report] FA --> CA[Corrective action] CA --> Tracking[Tracking] </pre>							
Q.A Activity	1. ISO 9001 Maintenance Activities 3. Equipment calibration 5. Standardization Management				2. Process improvement proposal 4. Education And Training Activities			

3.2. Inspection Specification

- ◆Scope : The document shall be applied to TFT-LCD Module for 3.5" ~15" (Ver.B01).
- ◆Inspection Standard : MIL-STD-105E Table Normal Inspection Single Sampling Level II.
- ◆Equipment : Gauge 、MIL-STD 、Powertip Tester 、Sample
- ◆Defect Level : Major Defect AQL : 0.4 ; Minor Defect AQL : 1.5
- ◆OUT Going Defect Level : Sampling.
- ◆Standard of the product appearance test :

a. Manner of appearance test :

- (1). The test best be under 20W×2 fluorescent light(about 300lux ~500lux)
 , and distance of view must be at 30~40 cm.
- (2). The test direction is base on about around 45° of vertical line.

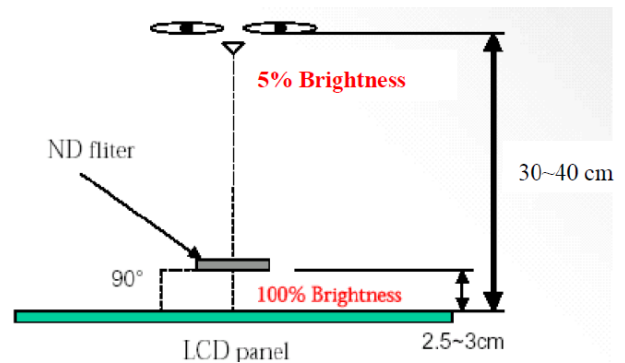
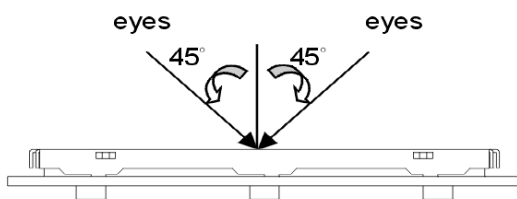

(3). Definition of area.

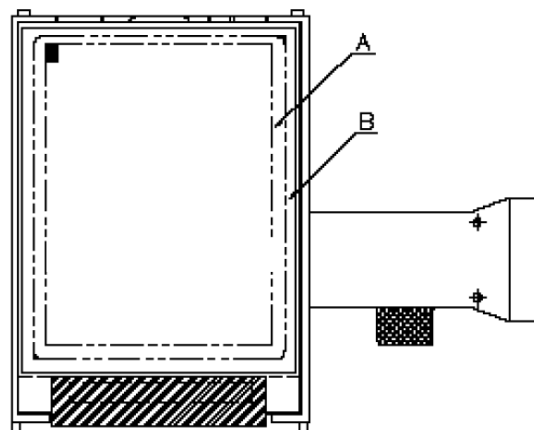

A area : viewing area

B area : Outside of viewing area

(4). Standard of inspection : (Unit : mm)

◆Specification For TFT-LCD Module 3.5" ~15" :

(Ver.B01)

NO	Item	Criterion	Level												
01	Product condition	1. 1The part number is inconsistent with work order of production.	Major												
		1. 2 Mixed product types.	Major												
		1. 3 Assembled in inverse direction.	Major												
02	Quantity	2. 1The quantity is inconsistent with work order of production.	Major												
03	Outline dimension	3. 1 Product dimension and structure must conform to structure diagram.	Major												
04	Electrical Testing	4. 1 Missing line character and icon.	Major												
		4. 2 No function or no display.	Major												
		4. 3 Display malfunction.	Major												
		4. 4 LCD viewing angle defect.	Major												
		4. 5 Current consumption exceeds product specifications.	Major												
		4. 6 Mura can not be seen through 5% ND filter at 50% Gray screen , should be judged by the viewing angle of 90 degree.	Minor												
05	Dot defect (Bright dot 、 Dark dot) On -display	<table border="1" style="margin-left: auto; margin-right: auto;"> <thead> <tr> <th colspan="2">Item</th> <th>Acceptance (Q'ty)</th> </tr> </thead> <tbody> <tr> <td rowspan="4" style="text-align: center; vertical-align: middle;">Dot Defect</td> <td style="text-align: center;">Bright Dot</td> <td style="text-align: center;">≤ 4</td> </tr> <tr> <td style="text-align: center;">Dark Dot</td> <td style="text-align: center;">≤ 5</td> </tr> <tr> <td style="text-align: center;">Joint Dot</td> <td style="text-align: center;">≤ 3</td> </tr> <tr> <td style="text-align: center;">Total</td> <td style="text-align: center;">≤ 7</td> </tr> </tbody> </table>	Item		Acceptance (Q'ty)	Dot Defect	Bright Dot	≤ 4	Dark Dot	≤ 5	Joint Dot	≤ 3	Total	≤ 7	Minor
		Item		Acceptance (Q'ty)											
Dot Defect	Bright Dot	≤ 4													
	Dark Dot	≤ 5													
	Joint Dot	≤ 3													
	Total	≤ 7													
5. 1 Inspection pattern : full white , full black , Red , Green and blue screens. 5. 2 It is defined as dot defect if defect area $> 1/2$ dot. 5. 3 The distance between two dot defect ≥ 5 mm. 5. 4 Bright dot that can not be seen through 5% ND filter.															

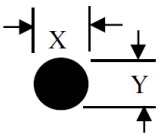
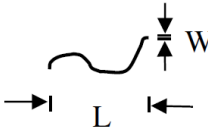

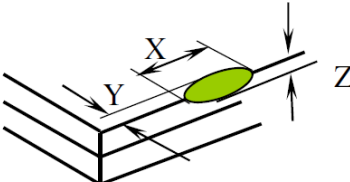
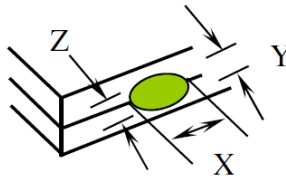
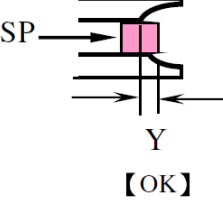
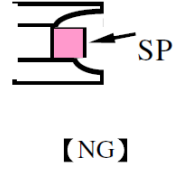
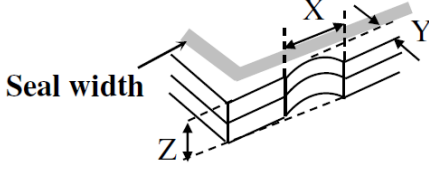
NO	Item	Criterion	Level																																						
06	Black or white dot、scratch、contamination Round type  $\Phi = (x + y) / 2$ Line type 	6.1 Round type (Non-display or display) : <table border="1"> <thead> <tr> <th rowspan="2">Dimension (diameter : Φ)</th> <th colspan="2">Acceptance (Q'ty)</th> </tr> <tr> <th>A area</th> <th>B area</th> </tr> </thead> <tbody> <tr> <td>$\Phi \leq 0.25$</td> <td colspan="2">Ignore</td> </tr> <tr> <td>$0.25 < \Phi \leq 0.50$</td> <td>5</td> <td rowspan="3">Ignore</td> </tr> <tr> <td>$\Phi > 0.50$</td> <td>0</td> </tr> <tr> <td>Total</td> <td>5</td> </tr> </tbody> </table>	Dimension (diameter : Φ)	Acceptance (Q'ty)		A area	B area	$\Phi \leq 0.25$	Ignore		$0.25 < \Phi \leq 0.50$	5	Ignore	$\Phi > 0.50$	0	Total	5	Minor																							
		Dimension (diameter : Φ)		Acceptance (Q'ty)																																					
A area	B area																																								
$\Phi \leq 0.25$	Ignore																																								
$0.25 < \Phi \leq 0.50$	5	Ignore																																							
$\Phi > 0.50$	0																																								
Total	5																																								
6.2 Line type(Non-display or display) : <table border="1"> <thead> <tr> <th rowspan="2">module size</th> <th rowspan="2">Length (L)</th> <th rowspan="2">Width (W)</th> <th colspan="2">Acceptance (Q'ty)</th> </tr> <tr> <th>A area</th> <th>B area</th> </tr> </thead> <tbody> <tr> <td rowspan="4">3.5" to less 9"</td> <td>---</td> <td>$W \leq 0.03$</td> <td>Ignore</td> <td rowspan="4">Ignore</td> </tr> <tr> <td>$L \leq 10.0$</td> <td>$0.03 < W \leq 0.05$</td> <td>4</td> </tr> <tr> <td>$L \leq 5.0$</td> <td>$0.05 < W \leq 0.10$</td> <td>2</td> </tr> <tr> <td>---</td> <td>$W > 0.10$</td> <td>As round type</td> </tr> <tr> <td colspan="3">Total</td> <td>5</td> <td></td> </tr> <tr> <td rowspan="4">9" to 15"</td> <td>---</td> <td>$W \leq 0.05$</td> <td>Ignore</td> <td rowspan="4">Ignore</td> </tr> <tr> <td>$L \leq 10.0$</td> <td>$0.05 < W \leq 0.10$</td> <td>5</td> </tr> <tr> <td>---</td> <td>$W > 0.10$</td> <td>As round type</td> </tr> <tr> <td colspan="3">Total</td> <td>5</td> </tr> </tbody> </table>	module size	Length (L)	Width (W)	Acceptance (Q'ty)		A area	B area	3.5" to less 9"	---	$W \leq 0.03$	Ignore	Ignore	$L \leq 10.0$	$0.03 < W \leq 0.05$	4	$L \leq 5.0$	$0.05 < W \leq 0.10$	2	---	$W > 0.10$	As round type	Total			5		9" to 15"	---	$W \leq 0.05$	Ignore	Ignore	$L \leq 10.0$	$0.05 < W \leq 0.10$	5	---	$W > 0.10$	As round type	Total			5
module size				Length (L)	Width (W)	Acceptance (Q'ty)																																			
	A area	B area																																							
3.5" to less 9"	---	$W \leq 0.03$	Ignore	Ignore																																					
	$L \leq 10.0$	$0.03 < W \leq 0.05$	4																																						
	$L \leq 5.0$	$0.05 < W \leq 0.10$	2																																						
	---	$W > 0.10$	As round type																																						
Total			5																																						
9" to 15"	---	$W \leq 0.05$	Ignore	Ignore																																					
	$L \leq 10.0$	$0.05 < W \leq 0.10$	5																																						
	---	$W > 0.10$	As round type																																						
	Total				5																																				
07	Polarizer Bubble	<table border="1"> <thead> <tr> <th rowspan="2">Dimension (diameter : Φ)</th> <th colspan="2">Acceptance (Q'ty)</th> </tr> <tr> <th>A area</th> <th>B area</th> </tr> </thead> <tbody> <tr> <td>$\Phi \leq 0.25$</td> <td colspan="2">Ignore</td> </tr> <tr> <td>$0.25 < \Phi \leq 0.50$</td> <td>4</td> <td rowspan="3">Ignore</td> </tr> <tr> <td>$0.50 < \Phi \leq 0.80$</td> <td>1</td> </tr> <tr> <td>$\Phi > 0.80$</td> <td>0</td> </tr> <tr> <td>Total</td> <td>5</td> <td></td> </tr> </tbody> </table>	Dimension (diameter : Φ)	Acceptance (Q'ty)		A area	B area	$\Phi \leq 0.25$	Ignore		$0.25 < \Phi \leq 0.50$	4	Ignore	$0.50 < \Phi \leq 0.80$	1	$\Phi > 0.80$	0	Total	5		Minor																				
Dimension (diameter : Φ)	Acceptance (Q'ty)																																								
	A area	B area																																							
$\Phi \leq 0.25$	Ignore																																								
$0.25 < \Phi \leq 0.50$	4	Ignore																																							
$0.50 < \Phi \leq 0.80$	1																																								
$\Phi > 0.80$	0																																								
Total	5																																								

NO	Item	Criterion	Level							
08	The crack of glass	<p>Symbols :</p> <p>X : The length of crack Y : The width of crack. Z : The thickness of crack W : terminal length t : The thickness of glass a : LCD side length</p>	Minor							
		<p>8.1 General glass chip :</p> <p>8.1.1 Chip on panel surface and crack between panels:</p> <div style="display: flex; justify-content: space-around; align-items: center;">   </div> <div style="display: flex; justify-content: space-around; align-items: center; margin-top: 20px;">   </div> <div style="text-align: center; margin-top: 20px;">  </div> <table border="1" style="margin-top: 20px; width: 100%; border-collapse: collapse;"> <thead> <tr> <th style="width: 25%;">X</th> <th style="width: 50%;">Y</th> <th style="width: 25%;">Z</th> </tr> </thead> <tbody> <tr> <td style="text-align: center;">$\leq a$</td> <td style="text-align: center;">Crack can't enter viewing area</td> <td style="text-align: center;">$\leq 1/2 t$</td> </tr> <tr> <td style="text-align: center;">$\leq a$</td> <td style="text-align: center;">Crack can't exceed the half of SP width.</td> <td style="text-align: center;">$1/2 t < Z \leq 2 t$</td> </tr> </tbody> </table>		X	Y	Z	$\leq a$	Crack can't enter viewing area	$\leq 1/2 t$	$\leq a$
X	Y	Z								
$\leq a$	Crack can't enter viewing area	$\leq 1/2 t$								
$\leq a$	Crack can't exceed the half of SP width.	$1/2 t < Z \leq 2 t$								

◆Specification For TFT-LCD Module 3. 5" ~15" :

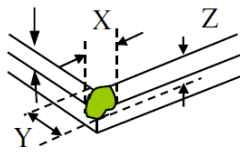
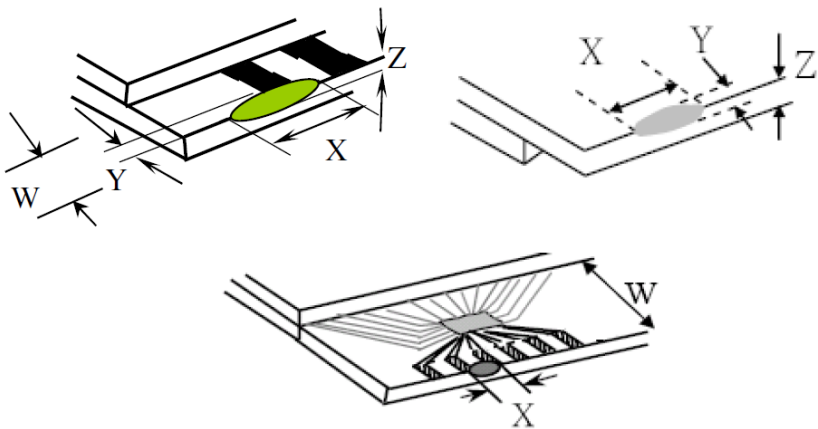
(Ver.B01)

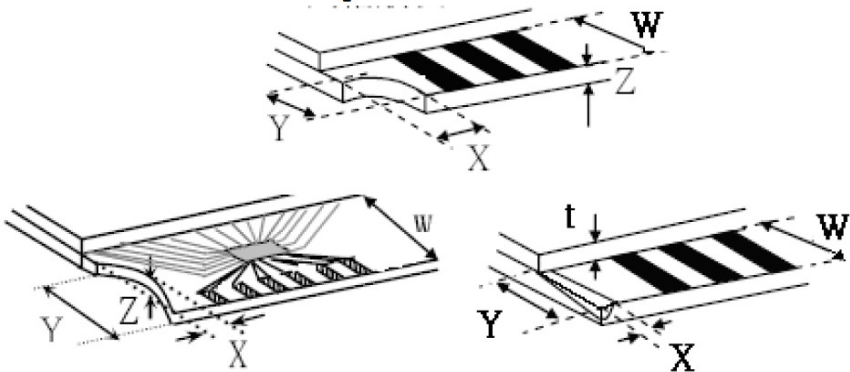
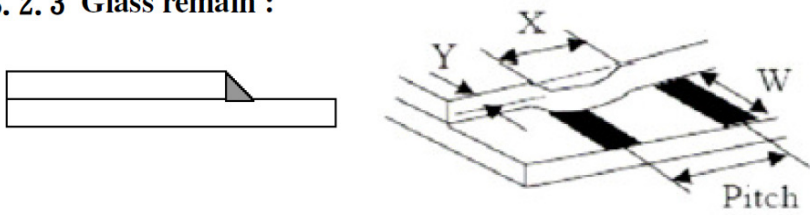
NO	Item	Criterion	Level												
08	The crack of glass	<p>Symbols :</p> <p>X : The length of crack Z : The thickness of crack t : The thickness of glass</p> <p>Y : The width of crack. W : terminal length a : LCD side length</p> <hr/> <p>8.1.2 Corner crack :</p>  <table border="1" data-bbox="529 750 1321 1034"> <thead> <tr> <th>X</th> <th>Y</th> <th>Z</th> </tr> </thead> <tbody> <tr> <td>$\leq 1/5 a$</td> <td>Crack can't enter viewing area</td> <td>$Z \leq 1/2 t$</td> </tr> <tr> <td>$\leq 1/5 a$</td> <td>Crack can't exceed the half of SP width.</td> <td>$1/2 t < Z \leq 2 t$</td> </tr> </tbody> </table>	X	Y	Z	$\leq 1/5 a$	Crack can't enter viewing area	$Z \leq 1/2 t$	$\leq 1/5 a$	Crack can't exceed the half of SP width.	$1/2 t < Z \leq 2 t$				
		X	Y	Z											
$\leq 1/5 a$	Crack can't enter viewing area	$Z \leq 1/2 t$													
$\leq 1/5 a$	Crack can't exceed the half of SP width.	$1/2 t < Z \leq 2 t$													
		<p>8.2 Protrusion over terminal :</p> <p>8.2.1 Chip on electrode pad :</p>  <table border="1" data-bbox="566 1657 1332 1825"> <thead> <tr> <th></th> <th>X</th> <th>Y</th> <th>Z</th> </tr> </thead> <tbody> <tr> <td>Front</td> <td>$\leq a$</td> <td>$\leq 1/2 W$</td> <td>$\leq t$</td> </tr> <tr> <td>Back</td> <td>$\leq a$</td> <td>$\leq W$</td> <td>$\leq 1/2 t$</td> </tr> </tbody> </table>		X	Y	Z	Front	$\leq a$	$\leq 1/2 W$	$\leq t$	Back	$\leq a$	$\leq W$	$\leq 1/2 t$	Minor
	X	Y	Z												
Front	$\leq a$	$\leq 1/2 W$	$\leq t$												
Back	$\leq a$	$\leq W$	$\leq 1/2 t$												

NO	Item	Criterion	Level												
08	The crack of glass	<p>Symbols :</p> <p>X : The length of crack Y : The width of crack. Z : The thickness of crack W : terminal length t : The thickness of glass a : LCD side length</p> <hr/> <p>8.2.2 Non-conductive portion :</p>  <table border="1" data-bbox="630 952 1252 1075"> <thead> <tr> <th>X</th> <th>Y</th> <th>Z</th> </tr> </thead> <tbody> <tr> <td>$\leq 1/3 a$</td> <td>$\leq W$</td> <td>$\leq t$</td> </tr> </tbody> </table> <p>⊙ If the chipped area touches the ITO terminal, over 2/3 of the ITO must remain and be inspected according to electrode terminal specifications.</p> <p>8.2.3 Glass remain :</p>  <table border="1" data-bbox="550 1489 1236 1624"> <thead> <tr> <th>X</th> <th>Y</th> <th>Z</th> </tr> </thead> <tbody> <tr> <td>$\leq a$</td> <td>$\leq 1/3 W$</td> <td>$\leq t$</td> </tr> </tbody> </table> <p>8.2.4 Cracking</p>  <p style="text-align: center;">Not Allowed</p>	X	Y	Z	$\leq 1/3 a$	$\leq W$	$\leq t$	X	Y	Z	$\leq a$	$\leq 1/3 W$	$\leq t$	Minor
		X	Y	Z											
$\leq 1/3 a$	$\leq W$	$\leq t$													
X	Y	Z													
$\leq a$	$\leq 1/3 W$	$\leq t$													

◆ Specification For TFT-LCD Module 3.5" ~15" :

(Ver.B01)

NO	Item	Criterion	Level
09	Backlight elements	9. 1 Backlight can't work normally.	Major
		9. 2 Backlight doesn't light or color is wrong.	Major
		9. 3 Illumination source flickers when lit.	Major
10	General appearance	10. 1 Pin type 、 quantity 、 dimension must match type in structure diagram.	Major
		10. 2 No short circuits in components on PCB or FPC.	Major
		10. 3 Parts on PCB or FPC must be: no wrong parts, missing parts or excess parts.	Major
		10. 4 Product packaging must the same as specified on packaging specification sheet.	Minor
		10. 5 The folding and peeled off in polarizer are not acceptable.	Minor
		10. 6 The PCB or FPC between B/L assembled distance(PCB or FPC) is ≤ 1.5 mm.	Minor

4. RELIABILITY TEST

4.1 Reliability Test Condition

(Ver.A01)

NO.	TEST ITEM	TEST CONDITION										
1	High Temperature Storage Test	Keep Ta in 90 ±5°C 500 hrs (Note 1,2,3,4)										
2	High Temperature Operating Test	Keep Tp in 85 ±5°C 500 hrs (Note 1,2,3,4)										
3	Low Temperature Storage Test	Keep Ta in -40 ±5°C 500 hrs (Note 1,2,3,4)										
4	Low Temperature Operating Test	Keep Ta in -30 ±5°C 500 hrs (Note 1,2,3,4)										
5	High Temperature / High Humidity Operating Test	Keep in 60 / 90% R.H duration for 500 hrs (Note 1,2,3,4)										
7	Temperature Cycling Storage Test	<p style="text-align: center;"> $-30^{\circ}\text{C} \xrightarrow{(30\text{mins})} +25^{\circ}\text{C} \xrightarrow{(5\text{mins})} 85^{\circ}\text{C} \xrightarrow{(30\text{mins})} +25^{\circ}\text{C} \xrightarrow{(5\text{mins})}$ 50 Cycle </p> <p>(Note 1,2,3,4)</p>										
9	ESD Test	Air Discharge: Apply 2 KV with 5 times Discharge for each polarity +/-										
		Contact Discharge: Apply 250 V with 5 times discharge for each polarity +/-										
		1. Temperature ambiance : 15°C ~ 35°C 2. Humidity relative : 30% ~ 60% 3. Energy Storage Capacitance(Cs+Cd) : 150pF±10% 4. Discharge Resistance(Rd) : 330Ω±10% 5. Discharge, mode of operation : Single Discharge (time between successive discharges at least 1 sec) (Tolerance if the output voltage indication : ±5%)										
10	Vibration Test (Packaged)	1. Sine wave 10~55 Hz frequency (1 min/sweep) 2. The amplitude of vibration : 1.5 mm 3. Each direction (X、Y、Z) duration for 2 Hrs										
11	Drop Test (Packaged)	<table border="1" style="width: 100%; text-align: center;"> <thead> <tr> <th>Packing Weight (Kg)</th> <th>Drop Height (cm)</th> </tr> </thead> <tbody> <tr> <td>0 ~ 45.4</td> <td>122</td> </tr> <tr> <td>45.4 ~ 90.8</td> <td>76</td> </tr> <tr> <td>90.8 ~ 454</td> <td>61</td> </tr> <tr> <td>Over 454</td> <td>46</td> </tr> </tbody> </table>	Packing Weight (Kg)	Drop Height (cm)	0 ~ 45.4	122	45.4 ~ 90.8	76	90.8 ~ 454	61	Over 454	46
		Packing Weight (Kg)	Drop Height (cm)									
0 ~ 45.4	122											
45.4 ~ 90.8	76											
90.8 ~ 454	61											
Over 454	46											
	Drop Direction : ※1 corner / 3 edges / 6 sides each 1time											

Note 1: Ta = Ambient Temperature, Tp = Panel Surface Temperature.

Note 2: Criteria: Normal display image with no obvious non-uniformity and no line defect.

Note 3: Evaluation should be tested after storage at room temperature for more than two hour

Note 4: A certain level of Mura (non-uniformity) of dark / black image will happen several days after



high temperature testing (H.T.T.). There is a slowly part recovery over a long time (several months). Such a long exposure time like in H.T.T. will normally not happen in a real application. Therefore the test H.T.T. was introduced to simulate cycles with normal conditions in-between but with the same total exposure time what show a significant reduced Mura.

The root cause is related to tension generated due to different amount of shrinking in the stack of layers in the polarizer sheet. The effect is more significant on larger displays like this size. An investigation into alternative polarizer material showed that there is no better alternative currently available.



5. PRECAUTION RELATING PRODUCT HANDLING

5.1 SAFETY

- 5.1.1 If the LCD panel breaks, be careful not to get the liquid crystal to touch your skin.
- 5.1.2 If the liquid crystal touches your skin or clothes, please wash it off immediately by using soap and water.

5.2 HANDLING

- 5.2.1 Avoid any strong mechanical shock which can break the glass.
- 5.2.2 Avoid static electricity which can damage the CMOS LSI—When working with the module, be sure to ground your body and any electrical equipment you may be using.
- 5.2.3 Do not remove the panel or frame from the module.
- 5.2.4 The polarizing plate of the display is very fragile. So, please handle it very carefully, do not touch, push or rub the exposed polarizing with anything harder than an HB pencil lead (glass, tweezers, etc.)
- 5.2.5 Do not wipe the polarizing plate with a dry cloth, as it may easily scratch the surface of plate.
- 5.2.6 Do not touch the display area with bare hands, this will stain the display area.
- 5.2.7 Do not use ketonics solvent & aromatic solvent. Use with a soft cloth soaked with a cleaning naphtha solvent.
- 5.2.8 To control temperature and time of soldering is $320 \pm 10^{\circ}\text{C}$ and 3-5 sec.
- 5.2.9 To avoid liquid (include organic solvent) stained on LCM
- 5.2.10 Caution!(LCM products with Capacitive Touch Panel)
Strong EMI-sources such as switch-mode power supplies (SMPS) can lead to touch malfunction (e.g. ghost-touches).
Therefore, the touch needs to be thoroughly tested inside the target application.
- 5.2.11 CAUTION: Continuously displaying same static image will result in high possibility of image sticking/image burn-in effect due to TFT panel characteristic.

5.3 STORAGE

- 5.3.1 Store the panel or module in a dark place where the temperature is $25^{\circ}\text{C} \pm 5^{\circ}\text{C}$ and the humidity is below 65% RH.
- 5.3.2 Do not place the module near organics solvents or corrosive gases.
- 5.3.3 Do not crush, shake, or jolt the module.

5.4 TERMS OF WARRANTY

- 5.4.1 Applicable warrant period The period is within thirteen months since the date of shipping out under normal using and storage conditions.
- 5.4.2 Unaccepted responsibility
This product has been manufactured to your company's specification as a part for use in your company's general electronic products. It is guaranteed to perform according to delivery specifications. For any other use apart from general electronic equipment, we cannot take responsibility if the product is used in nuclear power control equipment, aerospace equipment, fire and security systems or any other applications in which there is a direct risk to human life and where extremely high levels of reliability are required.

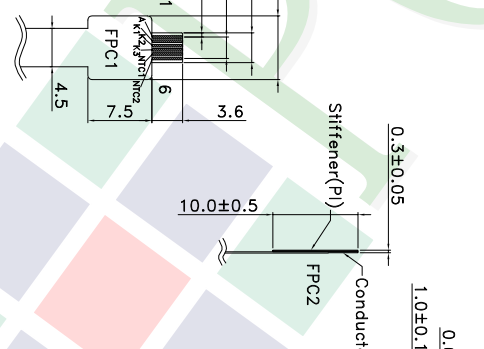
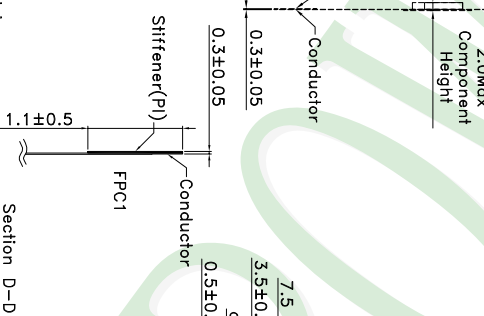
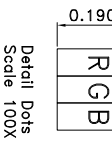
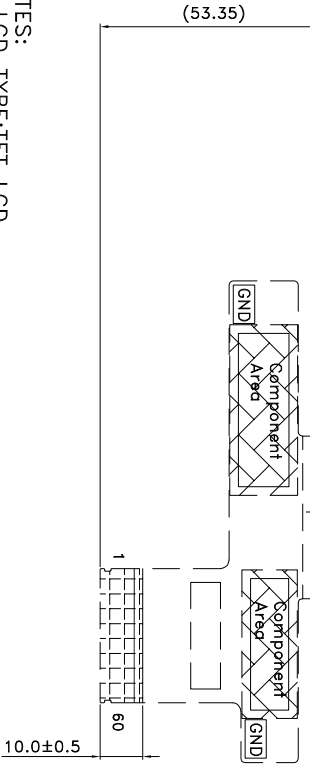
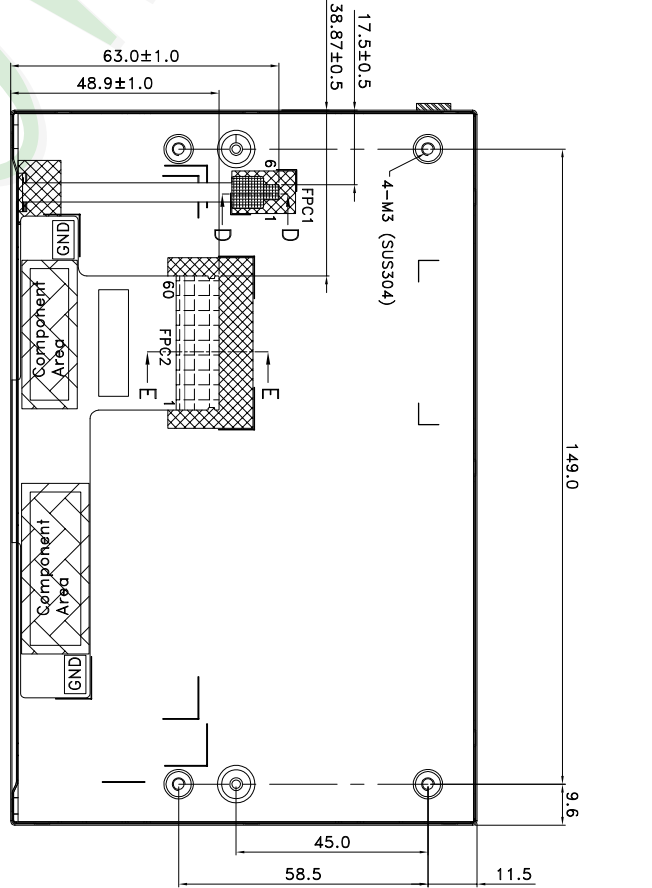
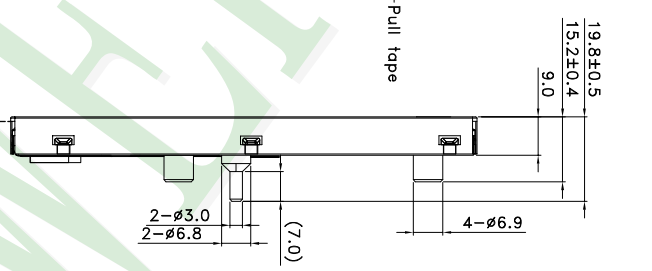
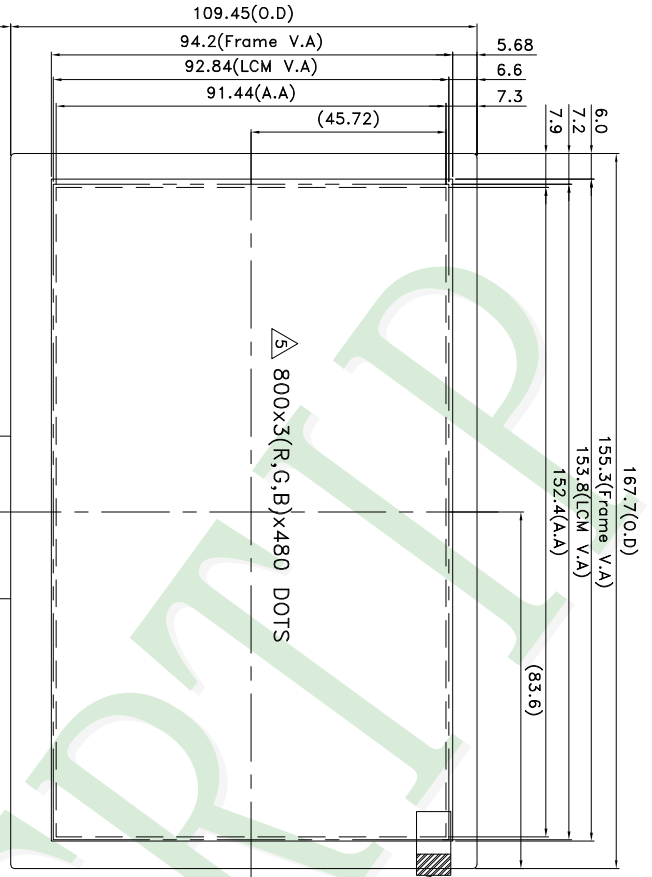

- NOTES:
- 1.LCD TYPE:TFT LCD
 - 2.LCD DISPLAY:Normally Black/Transmissive
 - 3.The tolerance unless classified $\pm 0.3\text{mm}$
 4. a : $P0.5^*5=2.5\pm 0.05$; $W=0.3\pm 0.05$
b : $P0.5^*59=29.5\pm 0.05$; $W=0.3\pm 0.05$
 5. :Kaption tape; :Black tape
 - 6.BL FPC1 suggested connector : "Hirose" FH19SC-6S-0.5SH, 6 PIN or compatible
 - 7.LCD FPC2 suggested connector : "IRISO" IMSA-12001S-60Y903, 60 PIN or compatible

007					
006					
005	Add Resolution	Clare	2020/02/24		
004	Add Dimensons & Black tape	Clare	2019/12/09		
003	Modify BL FPC design & FC design	Clare	2019/01/15		
002	Modify LCM design	Clare	2018/08/13		
001	NEW DRAWING	Clare	2018/06/01		
REV		REV BY	REVISER	DATE	

PART NO:		PH800480T027-ZHA	
DRAWING NAME:		LMD-PH800480T027-ZHA	
TITLE:		LCD MODULE DRAWING	
Design	Clare	Check	Tina
Approve	Jimmy		
Surface	MM	Material	
Unit	MM	Thickness	
Scale	FIT	Quantity	
Page	1/1		

久正光電股份有限公司
POWER TIP TECHNOLOGY CORPORATION

Surface	Unit	Material	Thickness	Quantity
(3)	MM		4 ~ 4	-
	MM		16 ~ 16	-
	MM		63 ~ 250	-
	MM		290 ~ 1000	-

LCM包裝規格書

LCM Packaging Specifications

(For Tray)

Approve	Check	Contact
Rex	Tina	Clare

1. 包裝材料規格表 (Packaging Material) : (per carton)

No.	Item	Model	Dimensions (mm)	1Pcs Weight	Quantity	Total Weight
1	成品 (LCM)	PH800480T027-ZHA	167.7 X 109.45	0.24	24	5.76
2	多層薄膜(1)POF	OTFILM0BA03ABA	19"X350X0.015	—	4	—
3	TRAY 盤 (2)Tray	TYSG000000473	352 X 260 X 29	0.1	16	1.6
4	內盒(3)Product Box	BX00000000022	393 X 274 X 107	0.25	4	1.0
5	保利龍板(4)Pollylon board	OTPLB00000008	550 X 393 X 15	0.022	2	0.044
6	外紙箱(5)Carton	BX57041027CCBA	570 X 410 X 265	1.0	1	1.0
7	舒美墊(6) EPE	FOAM000000047	350 X 255 X 5	0.011	4	0.044
8						
9						

2. 一整箱總重量 (Total LCD Weight in carton) : 9.45 Kg±10%

3. 單箱數量規格表 (Packaging Specifications and Quantity) :

(1) LCM quantity per box : no per tray	2	x no of tray	3	=	6
(2) Total LCM quantity in carton : quantity per box	6	x no of boxes	4	=	24

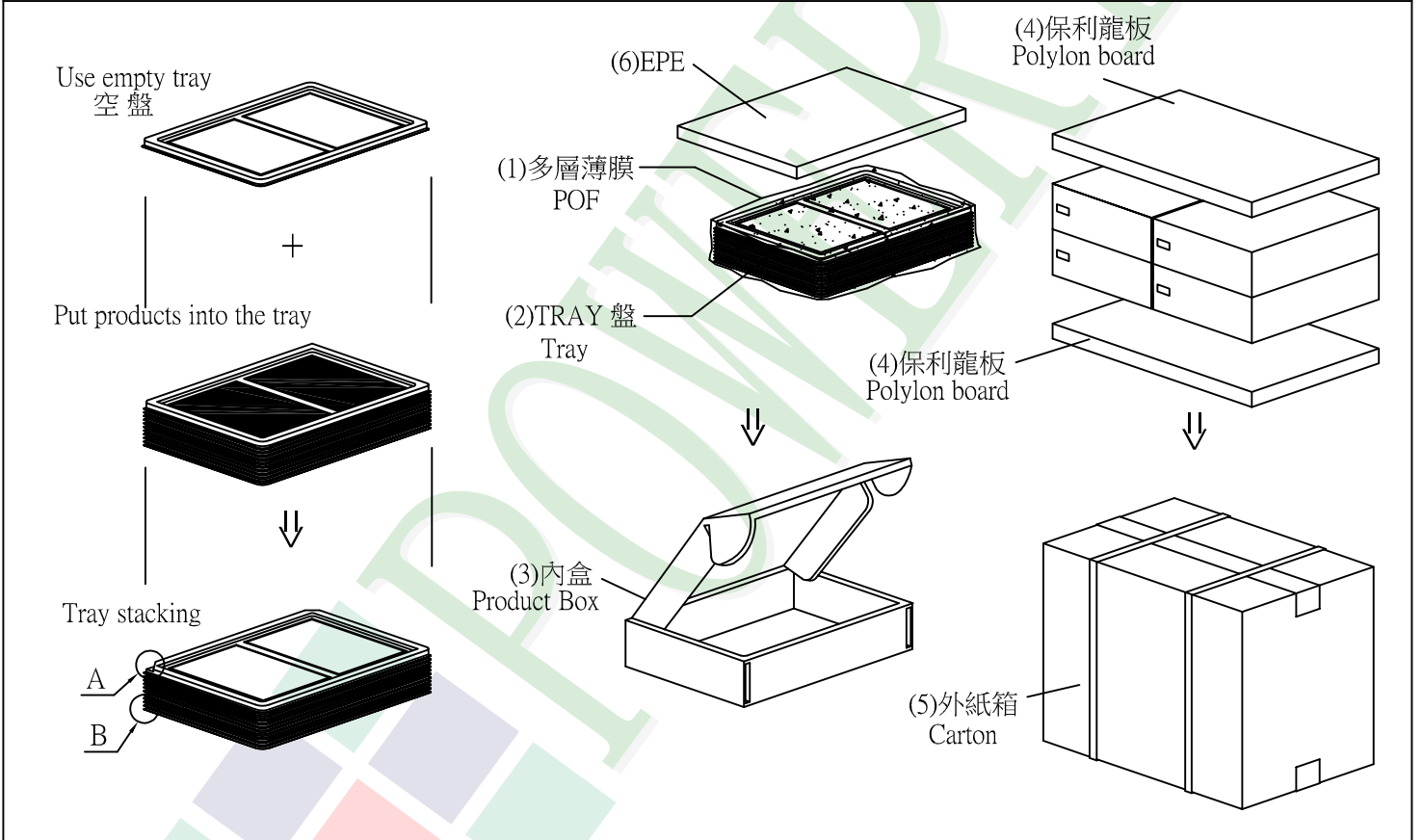

特 記 事 項 (REMARK)

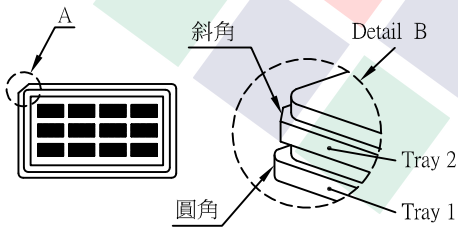

4. TRAY盤相疊時,需旋轉180度,請詳見B視圖
Rotate tray 180 degrees and place on top of stack.
Check the tray stack using Fig. B.

X-ON Electronics

Largest Supplier of Electrical and Electronic Components

Click to view similar products for [TFT Displays & Accessories category](#):

Click to view products by [Powertip manufacturer](#):

Other Similar products are found below :

[OAI-80038AA-2013-A](#) [HDA430T-3G1H](#) [T-51750GD065J-LW-BGN](#) [NB-ATT01](#) [NL8060BC26-35C](#) [TCG104SVLQAPNN-AN20](#) [OAI-80038AA-2008-A](#) [315-U004B15300](#) [EIC-LCD-1080P](#) [NL10276BC20-18C](#) [NLB121XG01L-01](#) [DEM 128160D](#) [TMH-PW-N](#) [RFE43BU-AIW-DNG](#) [RFC350X-AWW-DNG](#) [RFS390E-AWW-DNN](#) [DEM 480272G2](#) [VMX-PW-N \(A-TOUCH\)](#) [PH800480T013-ICA](#) [DEM 1024600N](#) [VMX-PW-N \(C-TOUCH\)](#) [DEM 1024600P](#) [VMH-PW-N \(C-TOUCH\)](#) [SM-RVT50HQHNWCA0](#) [DEM 240280A](#) [VMH-PW-N](#) [DEM 170320A](#) [VMH-PW-N](#) [PH240320T068-LAB08](#) [DEM 800480T1](#) [TMH-PW-N](#) [PH128128T041-LAA07](#) [DEM 800480Q4](#) [VMX-PW-N \(A-TOUCH\)](#) [PH480272T005-IAC02](#) [DEM 1024600P](#) [VMH-PW-N \(A-TOUCH\)](#) [DEM 800480T1](#) [TMH-PW-N \(C-TOUCH\)](#) [DEM 800480Q4](#) [VMX-PW-N](#) [DEM 800480T1](#) [TMH-PW-N \(A-TOUCH\)](#) [PH320240T-023-I02Q](#) [PH128800T004-ZZA01](#) [RFE430W-1YW-DBS](#) [DEM 1024600N](#) [VMX-PW-N \(A-TOUCH\)](#) [PH240320T074-ZAA01](#) [DEM 480480D](#) [VMX-PW-N \(C-TOUCH\)](#) [SM-RVT50HQSNWN00](#) [SM-RVT50HQHNWC00](#) [PH800480T033-ICB01](#) [RFE430W-AWW-DNN](#) [DEM 096096A](#) [VMH-PW-N](#) [RL0F00050000FGAAASA01](#) [PH320480T009-LAA01](#) [SM-RVT50HQSNWCA0](#) [SM-RVT50HQSNWC00-B](#) [PH320240T028-ZEA01](#) [RFE430W-1YW-DBN](#) [SM-RVT50HQLFWN00](#) [SM-RVT50HQHNWC00-B](#)