

Contents

1. SPECIFICATIONS

- 1.1 Features
- 1.2 Mechanical Specifications
- 1.3 Absolute Maximum Ratings
- 1.4 DC Electrical Characteristics
- 1.5 Optical Characteristics
- 1.6 Backlight Characteristics

2. MODULE STRUCTURE

- 2.1 Counter Drawing
- 2.2 Interface Pin Description
- 2.3 Timing Characteristics

3. QUALITY ASSURANCE SYSTEM

- 3.1 Quality Assurance Flow Chart
- 3.2 Inspection Specification

4. RELIABILITY TEST

- 4.1 Reliability Test Condition

5. PRECAUTION RELATING PRODUCT HANDLING

- 5.1 Safety
- 5.2 Handling
- 5.3 Storage
- 5.4 Terms of Warranty

Appendix : 1.LCM Drawing

2. Packing Specification

Note : For detailed information please refer to IC data sheet :

Primacy(TFT LCD):

ILITEK: ILI6122M / ILI5960

(Or compatible IC)

1. SPECIFICATIONS

1.1 Features

Item	Standard Value
Display Resolution	800 * 3 (RGB) * 480 Dots
LCD Type	a-Si TFT , Normally white, Transmissive type
Screen size(inch)	5.0 inch
Viewing Direction	6 O'clock (Gray scale Inversion) *1
	12 O'clock (*2)
Surface treatment	Anti-Glare
Color configuration	RGB Vertical Strip
Backlight Type	White LED B/L
Weight	60 g
Interface	24 Bits RGB interface
ROHS	THIS PRODUCT CONFORMS THE ROHS OF PTC Detail information please refer website : http://www.powertip.com.tw/news_detail.php?Key=1&cID=1

Note:

- *1. For saturated color display content (eg. pure-red, pure-green, pure-blue or pure-colors -combinations).
- *2. "For display content based upon multicolor images eg. photos, RGB defined user interfaces"

1.2 Mechanical Specifications

Item	Standard Value	Unit
Outline Dimension	121.0(W) x 75.9 (L) x 3.1(H)	mm

LCD panel

Item	Standard Value	Unit
Active Area	108.0 (W) * 64.8 (L)	mm

Note : For detailed information please refer to LCM drawing

1.3 Absolute Maximum Ratings

Module

Item	Symbol	Condition	Min.	Max.	Unit	Remark
Power Supply for TFT Panel	VDD	GND=0	-0.3	4.5	V	-
Power Supply for Backlight Unit	VCC	GND=0	-0.3	+20.0	V	
Operating Temperature	T _{OP} (Ts)	Note 1	-20	70	°C	
Storage Temperature	T _{ST} (Ta)	Note 2	-30	80	°C	

The absolute maximum rating values of this product are not allowed to be exceeded at any times. Should a module be used with any of the absolute maximum ratings exceeded, the characteristics of the module may not be recovered, or in an extreme case, the module may be permanently destroyed.

Note 1 : Ts is the temperature of panel's surface.

Note 2 : Ta is the ambient temperature of samples.

1.4 DC Electrical Characteristics

Module

GND = 0V, Ta = 25°C

Item	Symbol	Condition	Min.	Typ.	Max.	Unit
Power Supply for TFT Panel	VDD	GND=0V	3.0	3.3	3.6	V
Power Supply for Backlight Unit	VCC	GND=0V	5	12	15	V
Input Voltage for TFT Panel	V _{IH}	GND=0V	0.7VDD	-	VDD	V
	V _{IL}	GND=0V	0	-	0.3VDD	
Supply Current for TFT Panel	IDD	IDD@VDD=3.3V	-	90	140	mA
Supply Current for Backlight Unit	ICC	ICC@VCC=5V	-	400	600	
Supply Current for Backlight Unit	ICC	ICC@VCC=12V	-	150	250	
Input Voltage for PWM Signal	VPH	GND=0V	1.2	-	-	V
	VPL	GND=0V	-	-	0.4	V
Dimming Clock Rate	fP	GND=0V	5	-	100	KHz

1.5 Optical Characteristics

TFT LCD Module

VDD= 3.3 V, Ta=25°C

Item		Symbol	Condition	Min.	Typ.	Max.	unit	-
Response time	Tr+Tf	25°C	-	-	30	45	ms	-
Viewing angle	Top	$\theta Y+$	CR \geq 10		60	-	Deg.	Note 4
	Bottom	$\theta Y-$			60	-		
	Left	$\theta X-$			60	-		
	Right	$\theta X+$			60	-		
Contrast ratio		CR		500	600	-	-	Note 3
Color of CIE Coordinate (With B/L)	White	X	Ta = 25°C $\theta X, \theta Y = 0^\circ$	0.24	0.29	0.34	-	Note1
		Y		0.26	0.31	0.36		
	Red	X		0.51	0.56	0.61		
		Y		0.28	0.33	0.38		
	Green	X		0.29	0.34	0.39		
		Y		0.54	0.59	0.64		
	Blue	X		0.08	0.13	0.18		
		Y		0.03	0.08	0.13		
Average Brightness Pattern=white display (With LCD)*1		IV	VCC=5.0V PWM="High" (Duty=100%)	800	1000	-	cd/m2	Note1
Uniformity (With LCD)*2		ΔB	VCC=5.0V PWM="High" (Duty=100%)	70	-	-	%	Note1

Note 1:

*1 : $\Delta B = B(\min) / B(\max) * 100\%$

*2 : Measurement Condition for Optical Characteristics:

a : Environment: $25^{\circ}\text{C} \pm 5^{\circ}\text{C}$ / $60 \pm 20\%$ R.H , no wind , dark room below 10 Lux at typical lamp current and typical operating frequency.

b : Measurement Distance: 500 ± 50 mm , ($\theta = 0^{\circ}$)

c : Equipment: TOPCON BM-7 fast , (field 1°) , after 10 minutes operation.

d : The uncertainty of the C.I.E coordinate measurement ± 0.01 , Average Brightness $\pm 4\%$

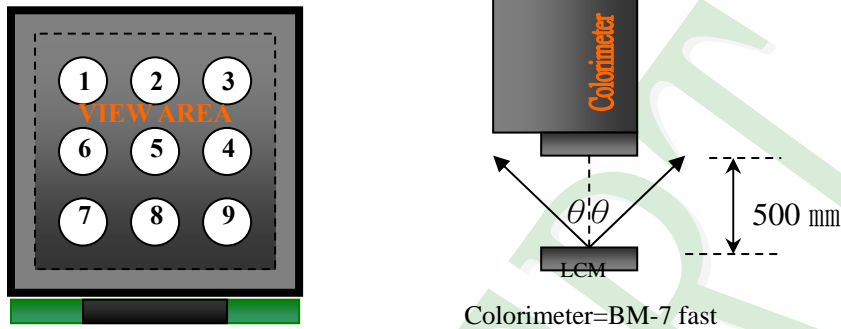

To be measured at the center area of panel with a viewing cone of 1° by Topcon luminance meter BM-7, after 10 minutes operation (module)

Note2: Definition of response time:

The output signals of photo detector are measured when the input signals are changed from "black" to "white"(falling time) and from "white" to "black"(rising time), respectively. The response time is defined as the time interval between the 10% and 90% of Amplitudes.

Refer to figure as below:

Normally White



Normally Black

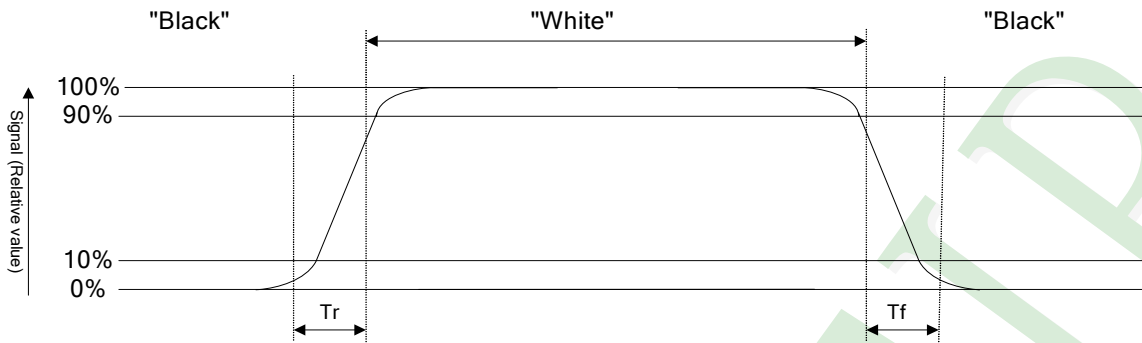

Note3: Definition of contrast ratio:

Contrast ratio is calculated with the following formula

$$\text{Contrast ratio (CR)} = \frac{\text{Photo detector output when LCD is at "White" state}}{\text{Photo detector output when LCD is at "Black" state}}$$

Note4: Definition of viewing angle:

Refer to figure as below:

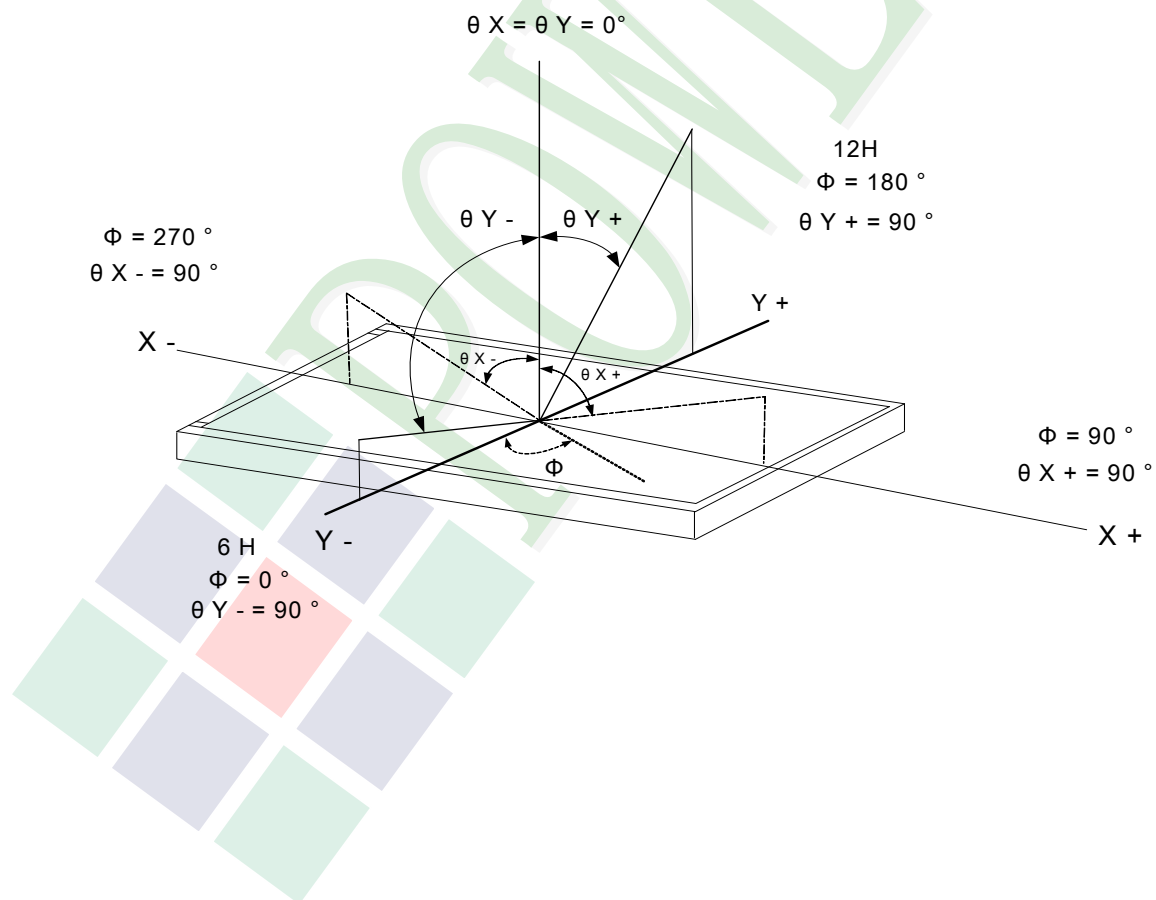

1.6 Backlight Characteristics

Maximum Ratings

Item	Symbol	Min.	Max.	Unit	Remark
LED Forward Current	I_F		180	mA	-
LED Reverse Voltage	V_R		30	V	

Electrical / Optical Characteristics

Item	Symbol	Min.	Typ.	Max.	Unit	Remark
LED Voltage	V_L	16.2	18.0	19.2	V	Note1
LED Current	I_L	-	90	-	mA	-
LED life time	-	50,000	-	-	H _r	Note2

Note 1: The LED Supply Voltage is defined by the number of LED at $T_a=25^\circ\text{C}$ and $I_L=90\text{ mA}$.

Note 2: The "LED life time" is defined as the module brightness decrease to 50% original brightness at $T_a=25^\circ\text{C}$ and $I_L=90\text{ mA}$. The LED life time could be decreased if operating I_L is larger than 90 mA.

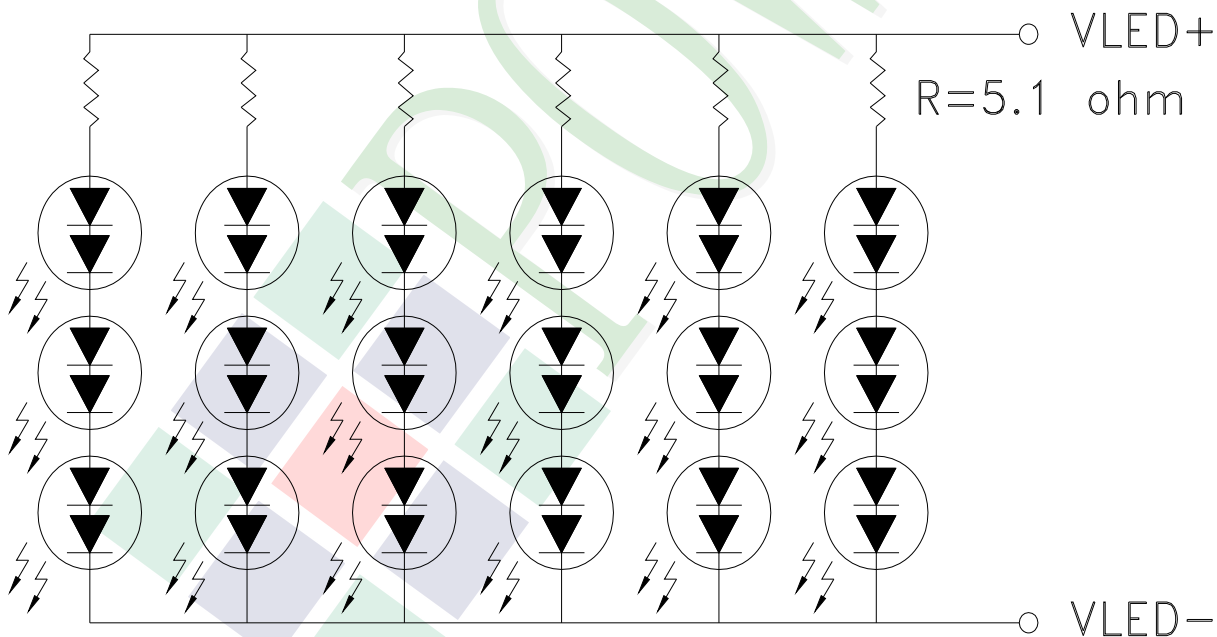

2. MODULE STRUCTURE

2.1 Counter Drawing

2.1.1 LCM Mechanical Diagram

* See Appendix

2.1.2 Block Diagram

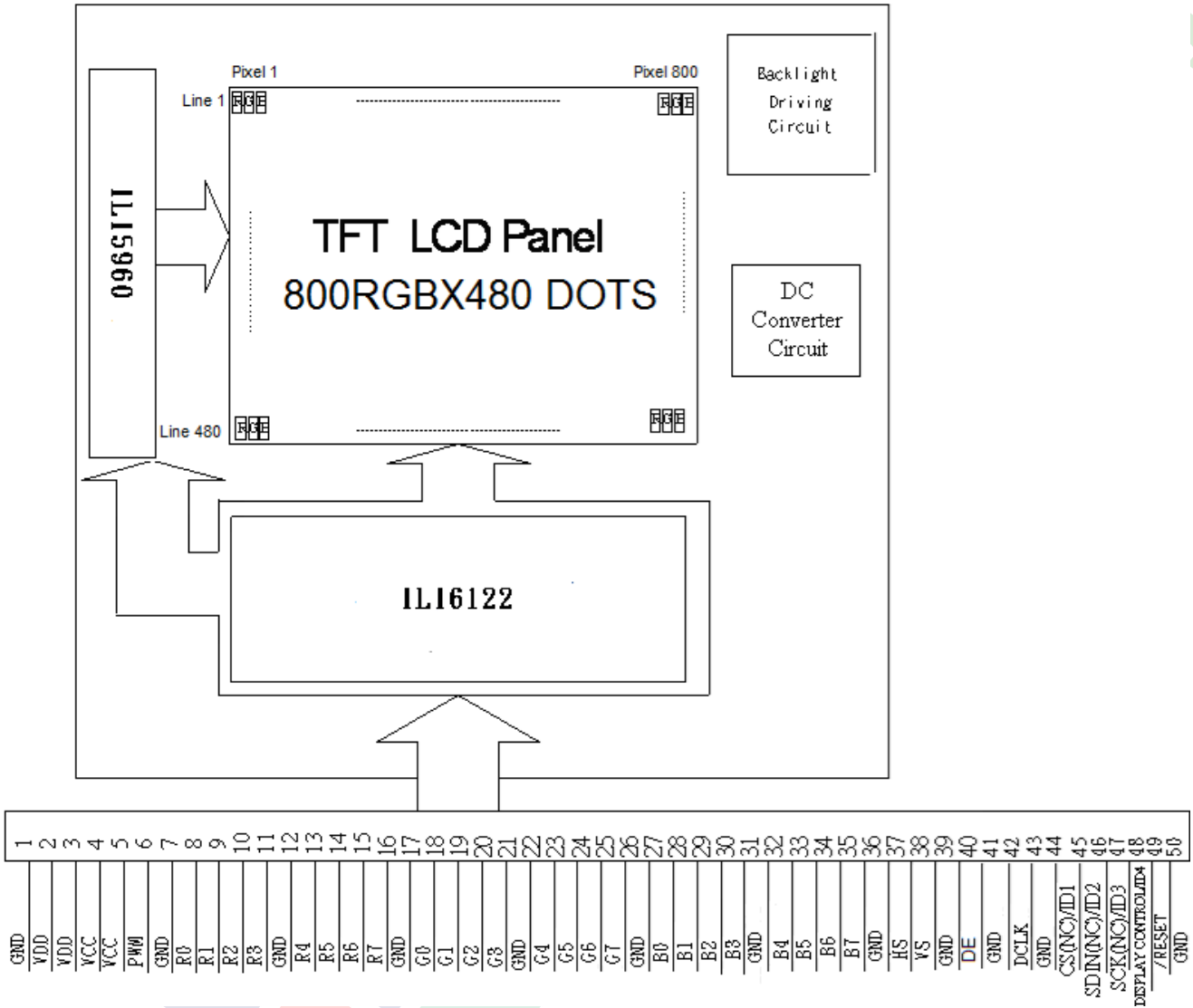

2.2 Interface Pin Description

TFT LCM Interface

Pin#	Name	DESCRIPTION
1	GND	Power ground.
2	VDD	Power for Digital Circuit.
3	VDD	Power for Digital Circuit.
4	VCC	Power For LED backlight.
5	VCC	Power For LED backlight.
6	PWM	Shutdown & Dimming control input for backlight. Do not allow this pin to float. "Hi" =100%, "Low" = 0%.
7	GND	Power ground.
8	R0	Red Data.
9	R1	Red Data.
10	R2	Red Data.
11	R3	Red Data.
12	GND	Power ground.
13	R4	Red Data.
14	R5	Red Data.
15	R6	Red Data.
16	R7	Red Data.
17	GND	Power ground.
18	G0	Green Data.
19	G1	Green Data.
20	G2	Green Data.
21	G3	Green Data.
22	GND	Power ground.
23	G4	Green Data.
24	G5	Green Data.
25	G6	Green Data.
26	G7	Green Data.
27	GND	Power ground.
28	B0	Blue Data.
29	B1	Blue Data.

Pin#	Name	DESCRIPTION
30	B2	Blue Data.
31	B3	Blue Data.
32	GND	Power ground.
33	B4	Blue Data.
34	B5	Blue Data.
35	B6	Blue Data.
36	B7	Blue Data.
37	GND	Power ground.
38	HS	Line synchronization signal. Horizontal Sync Input.
39	VS	Frame synchronization signal. Vertical Sync Input.
40	GND	Power ground.
41	DE	Display enable pin from controller. Data Input Enable.
42	GND	Power ground.
43	DCLK	Sample clock. Data will be latched at the falling edge of DCLK.
44	GND	Power ground.
45	CS(NC) / ID1	No Function./ ID[4:1]These pins select LCM type. See NOTE1
46	SDIN(NC) / ID2	No Function./ ID[4:1]These pins select LCM type. See NOTE1
47	SCK(NC) / ID3	No Function ./ ID[4:1]These pins select LCM type. See NOTE1
48	DISPLAY CONTROL / ID4	Display Enable(Hi Active)./ ID[4:1]These pins select LCM type. See NOTE1
49	/RESET	Global Reset (Low Active).
50	GND	Power ground.

Note1

ID Pins Definition:

	PIN 45 ID1	PIN 46 ID2	PIN 47 ID3	PIN 48 ID3
3.5" Module	X	0	0	X
4.3" Module	X	1	0	X
5.0" Module	X	0	1	X
7.0" Module	X	1	1	X

1. Resistor=10k ohm
2. "X"=No use .

2.3 Timing Characteristics

2.3.1 Input Clock and Data Timing

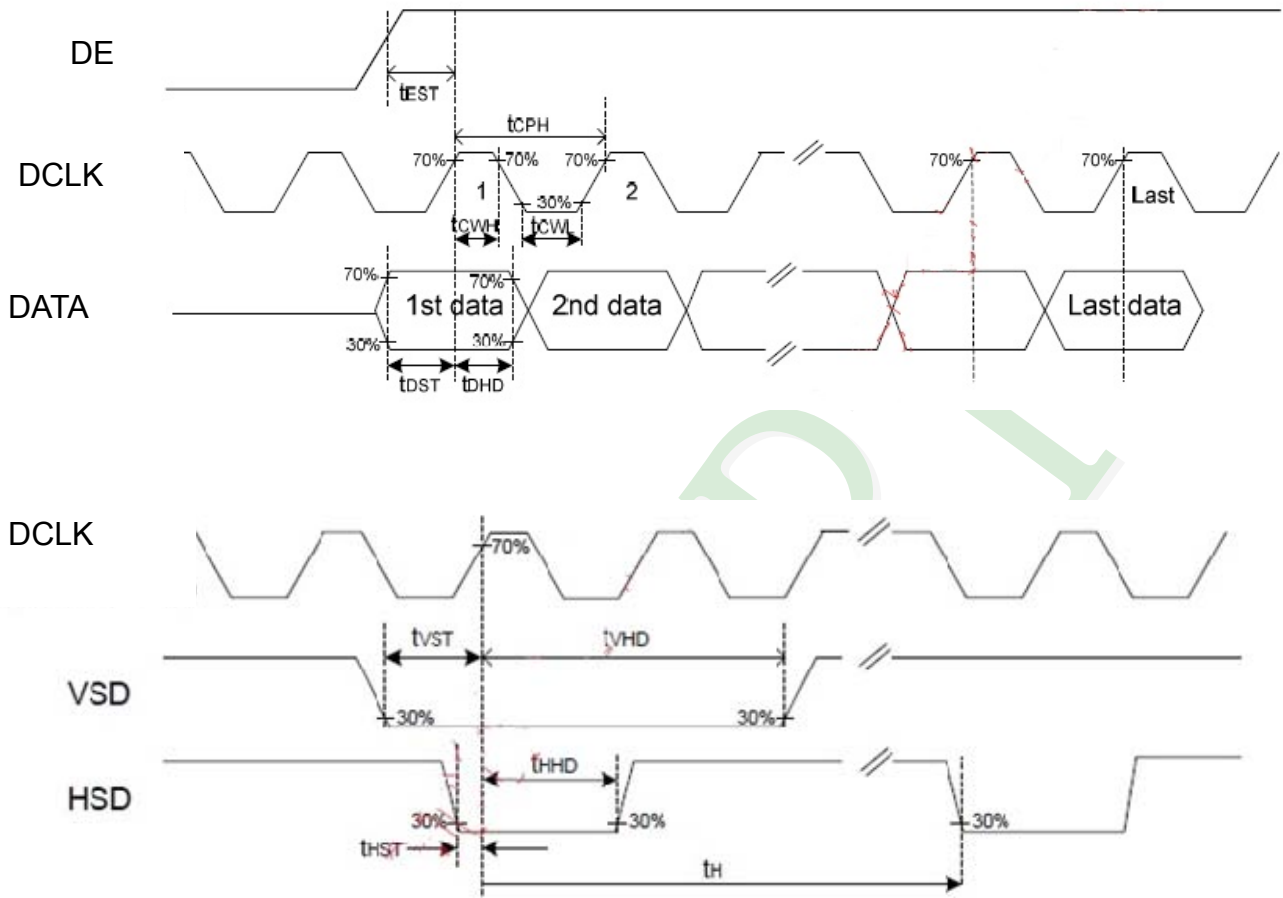

Parameters	Symbol	Spec			Unit	Conditions
		Min.	Typ.	Max.		
VDD Power ON slew rate	tPOR	--	--	20	ms	0V ~ 0.9VDD
RSTB pulse width	trST	10	--	--	us	CLKIN=50MHz
CLKIN cycle time	tCPH	20	--	--	ns	
CLKIN pulse duty	tcWH	40	50	60	%	
VSD setup time	tvST	8	--	--	ns	
VSD hold time	tvHD	8	--	--	ns	
HSD setup time	thST		--	--	ns	
HSD hold time	thHD	8	--	--	ns	
Data setup time	tdST	8	--	--	ns	D0[7:0], D1[7:0], D2[7:0] to CLKIN
Data hold time	tdHD	8	--	--	ns	D0[7:0], D1[7:0], D2[7:0] to CLKIN
DE setup time	teST	8	--	--	ns	
DE hold time	teHD	8	--	--	ns	
Output stable time	tsST	--	--	6	us	10% to 90% target voltage. CL=120pF, R=10KW
CLKIN frequency	fCLK	--	40	50	MHZ	VDD=3.0 ~ 3.6V
CLKIN cycle time	fCLK	20	25	--	ns	
CLKIN pulse duty	tcWH	40	50	60	%	TCLK
Time from HSD to Source output	thSO	--	20	--	CLKIN	
Time from HSD to LD	thLD	--	20	--	CLKIN	Note (2)
Time from HSD to STV	thSTV	--	2	--	CLKIN	
Time from HSD to CKV	thCKV		20	--	CLKIN	
Time from HSD to OEV	thOEV	--	4	--	CLKIN	
LD pulse width	twLD	--	10		CLKIN	Note (2)
CKV pulse width	twCKV	--	66	--	CLKIN	
OEV pulse width	twoEV	--	74	--	CLKIN	

Note: (1) VDD=3.0 ~ 3.6V, VDDA=6.5~13.5V, DGND=AGND=0V, Ta=-20~+85°C

(2) The contents of the data register are transferred to the latch circuit at the rising edge of LD. Then the gray scale voltage is output from the device at the falling edge of LD.

2.3.2 Vertical input timing

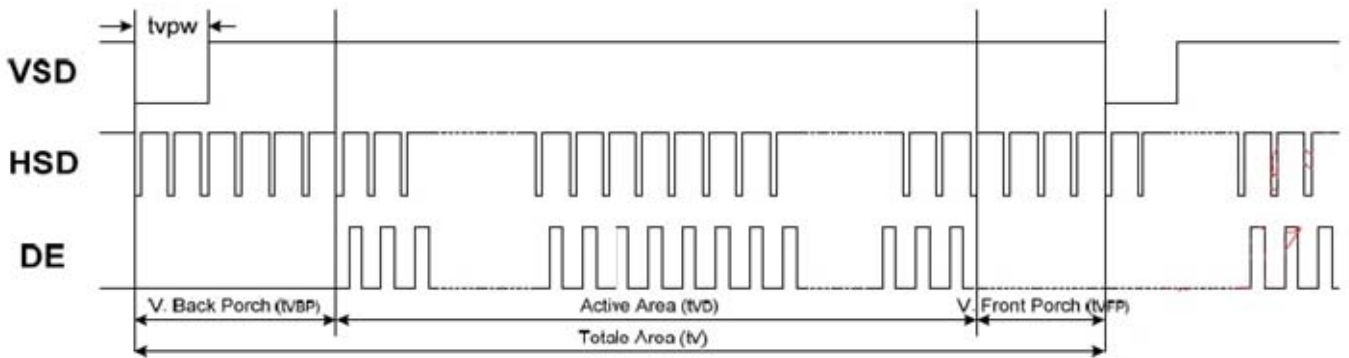

Parameter	Symbol	Value			Unit
		Min	Typ	Max	
Vertical display area	tvd		480		H
VSYNC period time	tv	510	525	650	H
VSYNC pulse width	tpwv	1	-	20	H
VSYNC ack Porch(Blanking)	tvb	23	23	23	H
VSYNC Front Proch	tvfb	7	22	147	H

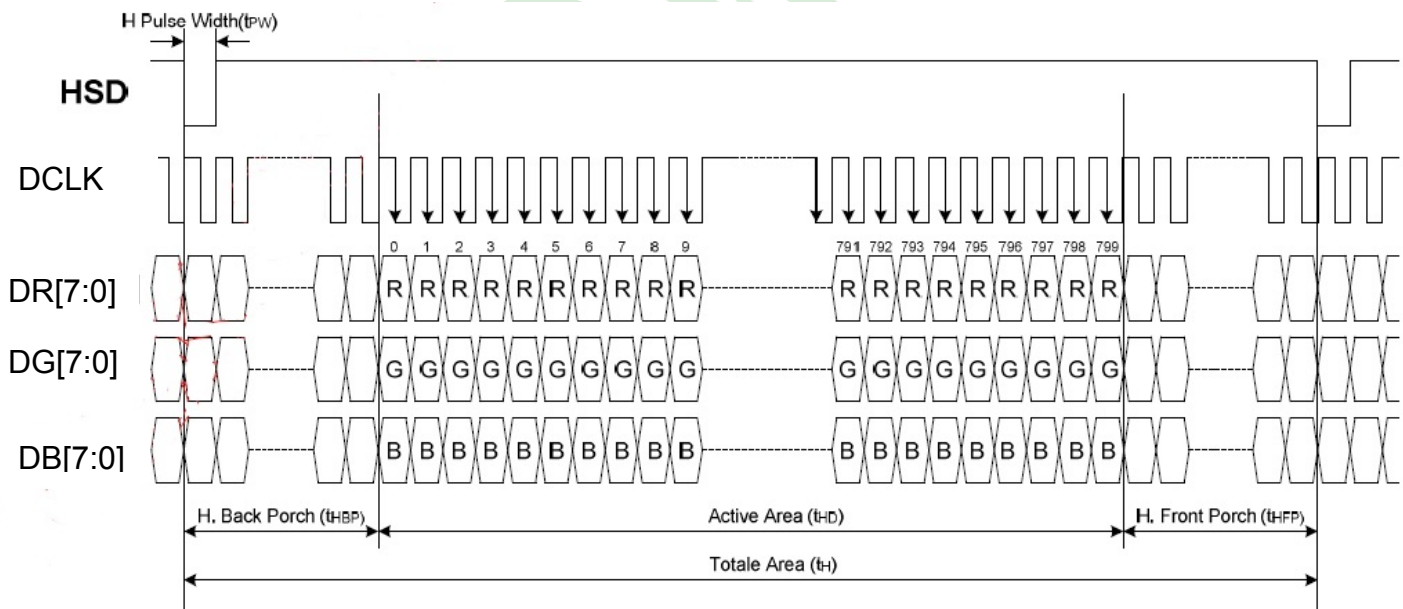

Parameter	Symbol	Value			Unit
		Min	Typ	Max	
Horizontal display area	thd	800			DCLK
DCLK frequency	fclk	-	33.3	50	MHz
1 Horizontal Line	th	862	1056	1200	DCLK
HSD pulse width	Min	-	1	-	
	Typ	-	-	-	
	Max	-	40	-	
HSD Back Porch (Blacking)	thp	46	46	46	
HSD Front Proch	thfb	16	210	354	

3. QUALITY ASSURANCE SYSTEM

3.1 Quality Assurance Flow Chart

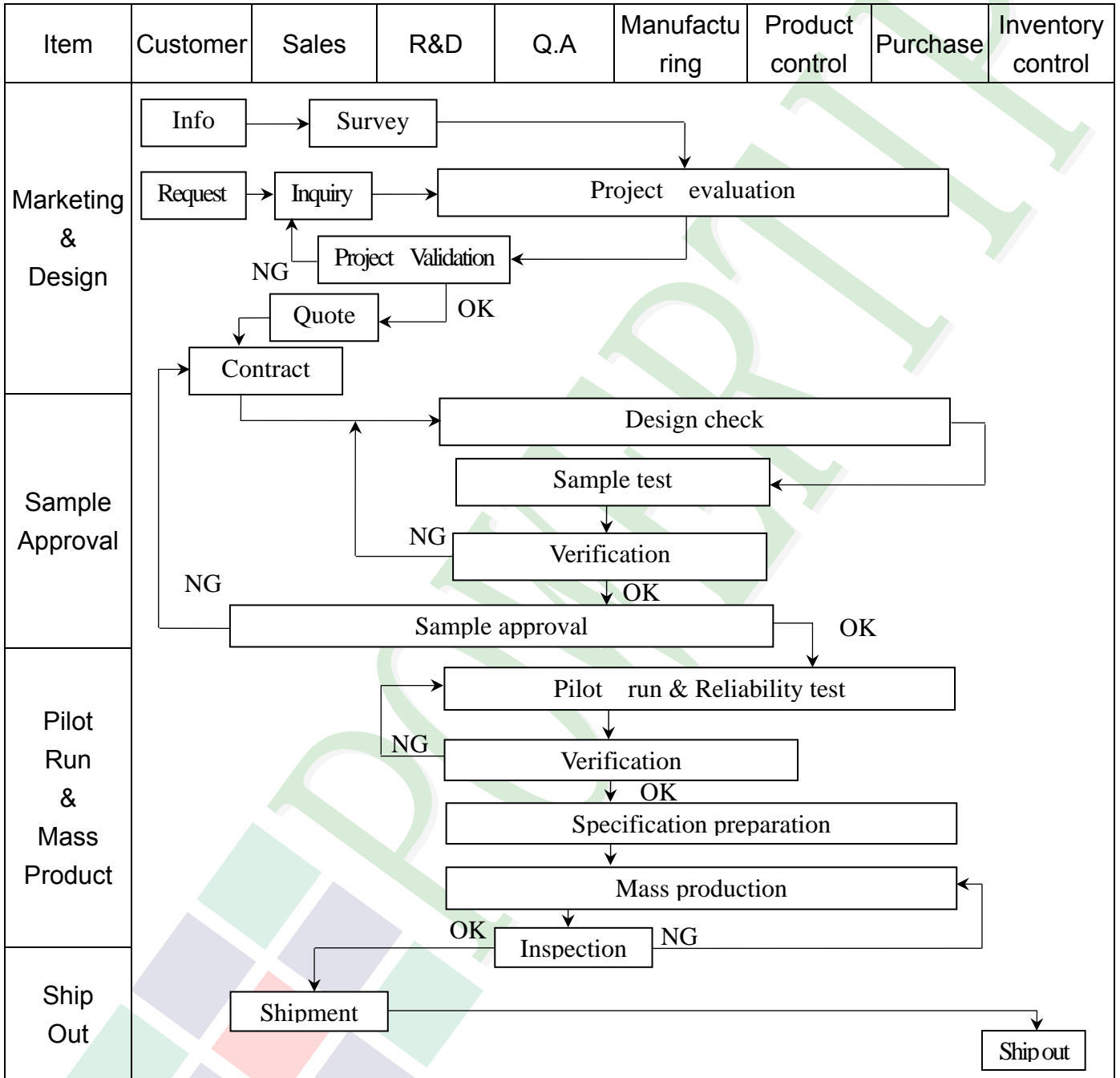

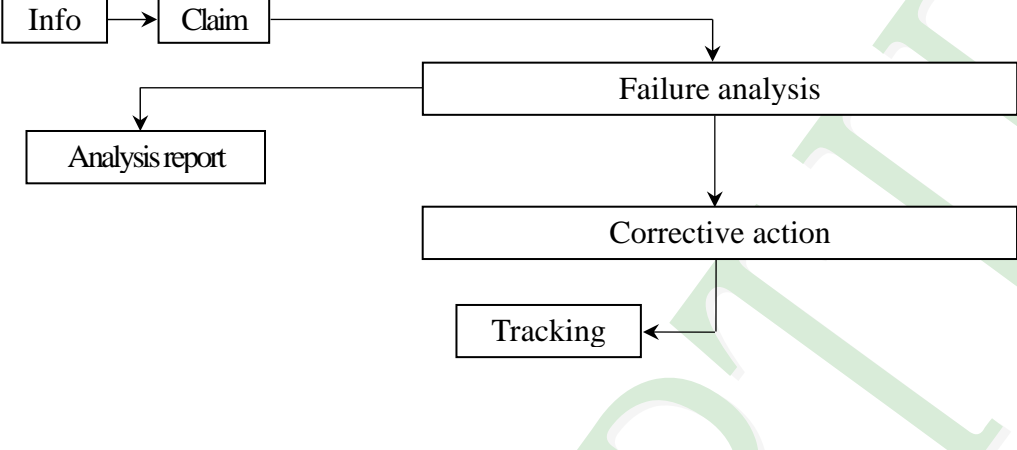
Item	Customer	Sales	R&D	Q.A	Manufacturing	Product control	Purchase	Inventory control
Sales Service	 <pre> graph TD Info[Info] --> Claim[Claim] Claim --> FA[Failure analysis] Claim --> AR[Analysis report] FA --> CA[Corrective action] CA --> Tracking[Tracking] </pre>							
Q.A Activity	1. ISO 9001 Maintenance Activities 3. Equipment calibration 5. Standardization Management				2. Process improvement proposal 4. Education And Training Activities			

3.2. Inspection Specification

- ◆Scope: The document shall be applied to TFT-LCD Module for 3.5" -15" (Ver.B01).
- ◆Inspection Standard: MIL-STD-105E Table Normal Inspection Single Sampling Level II.
- ◆Equipment: Gauge, MIL-STD, Powertip Tester, Sample
- ◆Defect Level: Major Defect AQL: 0. 4; Minor Defect AQL: 1. 5
- ◆OUT Going Defect Level: Sampling.
- ◆Standard of the product appearance test:

a. Manner of appearance test:

- (1). The test best be under 20W×2 fluorescent light(about 300lux ~500lux)
 , and distance of view must be at 30~40 cm.
- (2). The test direction is base on about around 45° of vertical line.

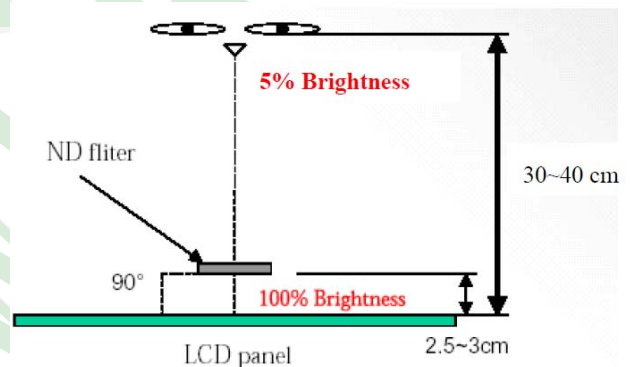
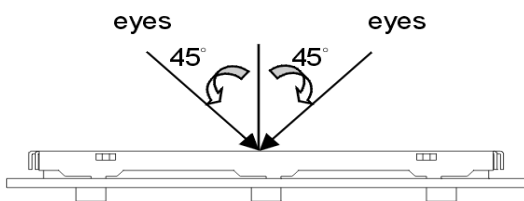

(3). Definition of area.

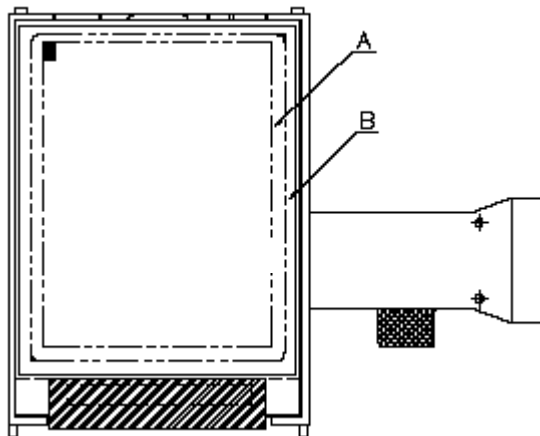

A area: viewing area

B area: Outside of viewing area

(4). Standard of inspection : (Unit : mm)

◆Specification For TFT-LCD Module 3.5" ~15" :
(Ver.B01)

NO	Item	Criterion	Level												
01	Product condition	1. 1The part number is inconsistent with work order of production.	Major												
		1. 2 Mixed product types.	Major												
		1. 3 Assembled in inverse direction.	Major												
02	Quantity	2. 1The quantity is inconsistent with work order of production.	Major												
03	Outline dimension	3. 1Product dimension and structure must conform to structure diagram.	Major												
04	Electrical Testing	4. 1 Missing line character and icon.	Major												
		4. 2 No function or no display.	Major												
		4. 3 Display malfunction.	Major												
		4. 4 LCD viewing angle defect.	Major												
		4. 5 Current consumption exceeds product specifications.	Major												
		4. 6Mura cannot be seen through 5% ND filter at 50% Gray , should be judged by the viewing angle of 90 degree.	Minor												
05	Dot defect (Bright dot, Dark dot) On -display	<table border="1" style="margin-left: auto; margin-right: auto;"> <thead> <tr> <th colspan="2">Item</th> <th>Acceptance (Q'ty)</th> </tr> </thead> <tbody> <tr> <td rowspan="4" style="text-align: center; vertical-align: middle;">Dot Defect</td> <td style="text-align: center;">Bright Dot</td> <td style="text-align: center;">≤ 4</td> </tr> <tr> <td style="text-align: center;">Dark Dot</td> <td style="text-align: center;">≤ 5</td> </tr> <tr> <td style="text-align: center;">Joint Dot</td> <td style="text-align: center;">≤ 3</td> </tr> <tr> <td style="text-align: center;">Total</td> <td style="text-align: center;">≤ 7</td> </tr> </tbody> </table>	Item		Acceptance (Q'ty)	Dot Defect	Bright Dot	≤ 4	Dark Dot	≤ 5	Joint Dot	≤ 3	Total	≤ 7	Minor
		Item		Acceptance (Q'ty)											
Dot Defect	Bright Dot	≤ 4													
	Dark Dot	≤ 5													
	Joint Dot	≤ 3													
	Total	≤ 7													
5. 1 Inspection pattern: full white, full black, Red, Green and blue screens. 5. 2 It is defined as dot defect if defect area $> 1/2$ dot. 5. 3 The distance between two dot defect ≥ 5 mm. 5. 4 Bright dot that can not be seen through 5% ND filter.															

◆Specification For TFT-LCD Module 3.5" ~15" :

(Ver.B01)

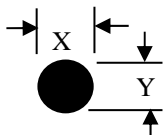
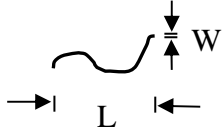
NO	Item	Criterion	Level																																																										
06	Black or white Dot, scratch, contamination Round type  $\Phi = (x + y) / 2$ Line type 	6. 1 Round type (Non-display or display): <table border="1"> <thead> <tr> <th rowspan="2">Dimension (diameter : Φ)</th> <th colspan="2">Acceptance (Q'ty)</th> </tr> <tr> <th>A area</th> <th>B area</th> </tr> </thead> <tbody> <tr> <td>$\Phi \leq 0.25$</td> <td colspan="2">Ignore</td> </tr> <tr> <td>$0.25 < \Phi \leq 0.50$</td> <td>5</td> <td rowspan="3">Ignore</td> </tr> <tr> <td>$\Phi > 0.50$</td> <td>0</td> </tr> <tr> <td>Total</td> <td>5</td> </tr> </tbody> </table> 6. 2 Line type(Non-display or display): <table border="1"> <thead> <tr> <th rowspan="2">module size</th> <th rowspan="2">Length (L)</th> <th rowspan="2">Width (W)</th> <th colspan="2">Acceptance (Q'ty)</th> </tr> <tr> <th>A area</th> <th>B area</th> </tr> </thead> <tbody> <tr> <td rowspan="4">3.5" to less 9"</td> <td>---</td> <td>$W \leq 0.03$</td> <td colspan="2">Ignore</td> </tr> <tr> <td>$L \leq 10.0$</td> <td>$0.03 < W \leq 0.05$</td> <td>4</td> <td rowspan="3">Ignore</td> </tr> <tr> <td>$L \leq 5.0$</td> <td>$0.05 < W \leq 0.10$</td> <td>2</td> </tr> <tr> <td>---</td> <td>$W > 0.10$</td> <td>As round type</td> </tr> <tr> <td colspan="3">Total</td> <td>5</td> <td></td> </tr> <tr> <td rowspan="4">9" to 15"</td> <td>---</td> <td>$W \leq 0.05$</td> <td colspan="2">Ignore</td> </tr> <tr> <td>$L \leq 10.0$</td> <td>$0.05 < W \leq 0.10$</td> <td>5</td> <td rowspan="3">Ignore</td> </tr> <tr> <td>---</td> <td>$W > 0.10$</td> <td>As round type</td> </tr> <tr> <td colspan="3">Total</td> <td>5</td> </tr> </tbody> </table>	Dimension (diameter : Φ)	Acceptance (Q'ty)		A area	B area	$\Phi \leq 0.25$	Ignore		$0.25 < \Phi \leq 0.50$	5	Ignore	$\Phi > 0.50$	0	Total	5	module size	Length (L)	Width (W)	Acceptance (Q'ty)		A area	B area	3.5" to less 9"	---	$W \leq 0.03$	Ignore		$L \leq 10.0$	$0.03 < W \leq 0.05$	4	Ignore	$L \leq 5.0$	$0.05 < W \leq 0.10$	2	---	$W > 0.10$	As round type	Total			5		9" to 15"	---	$W \leq 0.05$	Ignore		$L \leq 10.0$	$0.05 < W \leq 0.10$	5	Ignore	---	$W > 0.10$	As round type	Total			5	Minor
Dimension (diameter : Φ)	Acceptance (Q'ty)																																																												
	A area	B area																																																											
$\Phi \leq 0.25$	Ignore																																																												
$0.25 < \Phi \leq 0.50$	5	Ignore																																																											
$\Phi > 0.50$	0																																																												
Total	5																																																												
module size	Length (L)	Width (W)	Acceptance (Q'ty)																																																										
			A area	B area																																																									
3.5" to less 9"	---	$W \leq 0.03$	Ignore																																																										
	$L \leq 10.0$	$0.03 < W \leq 0.05$	4	Ignore																																																									
	$L \leq 5.0$	$0.05 < W \leq 0.10$	2																																																										
	---	$W > 0.10$	As round type																																																										
Total			5																																																										
9" to 15"	---	$W \leq 0.05$	Ignore																																																										
	$L \leq 10.0$	$0.05 < W \leq 0.10$	5	Ignore																																																									
	---	$W > 0.10$	As round type																																																										
	Total				5																																																								
07	Polarizer Bubble	<table border="1"> <thead> <tr> <th rowspan="2">Dimension (diameter: Φ)</th> <th colspan="2">Acceptance (Q'ty)</th> </tr> <tr> <th>A area</th> <th>B area</th> </tr> </thead> <tbody> <tr> <td>$\Phi \leq 0.25$</td> <td colspan="2">Ignore</td> </tr> <tr> <td>$0.25 < \Phi \leq 0.50$</td> <td>4</td> <td rowspan="3">Ignore</td> </tr> <tr> <td>$0.50 < \Phi \leq 0.80$</td> <td>1</td> </tr> <tr> <td>$\Phi > 0.80$</td> <td>0</td> </tr> <tr> <td>Total</td> <td>5</td> <td></td> </tr> </tbody> </table>	Dimension (diameter: Φ)	Acceptance (Q'ty)		A area	B area	$\Phi \leq 0.25$	Ignore		$0.25 < \Phi \leq 0.50$	4	Ignore	$0.50 < \Phi \leq 0.80$	1	$\Phi > 0.80$	0	Total	5		Minor																																								
Dimension (diameter: Φ)	Acceptance (Q'ty)																																																												
	A area	B area																																																											
$\Phi \leq 0.25$	Ignore																																																												
$0.25 < \Phi \leq 0.50$	4	Ignore																																																											
$0.50 < \Phi \leq 0.80$	1																																																												
$\Phi > 0.80$	0																																																												
Total	5																																																												

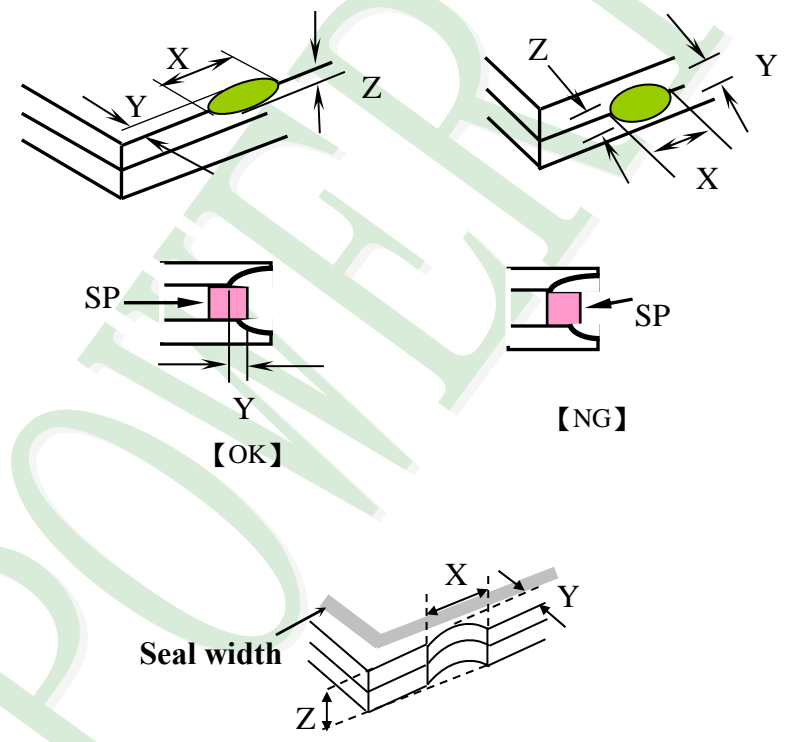
NO	Item	Criterion	Level									
08	The crack of glass	<p>Symbols :</p> <p>X: The length of crack Z: The thickness of crack t: The thickness of glass</p> <p>Y: The width of crack. W: terminal length a: LCD side length</p> <hr/> <p>8.1 General glass chip: 8.1.1 Chip on panel surface and crack between panels:</p>  <p>The diagrams illustrate various crack and chip scenarios. The top two diagrams show chips on the panel surface with labels X (length), Y (width), and Z (thickness). The middle two diagrams show cracks between panels, with labels SP (seal width) and Y (crack width). The left diagram is labeled [OK] and the right is labeled [NG]. The bottom diagram shows a crack between panels with labels X, Y, Z, and Seal width.</p> <table border="1" data-bbox="539 1579 1353 1870"> <thead> <tr> <th>X</th> <th>Y</th> <th>Z</th> </tr> </thead> <tbody> <tr> <td>$\leq a$</td> <td>Crack can't enter viewing area</td> <td>$\leq 1/2 t$</td> </tr> <tr> <td>$\leq a$</td> <td>Crack can't exceed the half of SP width.</td> <td>$1/2 t < Z \leq 2 t$</td> </tr> </tbody> </table>	X	Y	Z	$\leq a$	Crack can't enter viewing area	$\leq 1/2 t$	$\leq a$	Crack can't exceed the half of SP width.	$1/2 t < Z \leq 2 t$	Minor
		X	Y	Z								
$\leq a$	Crack can't enter viewing area	$\leq 1/2 t$										
$\leq a$	Crack can't exceed the half of SP width.	$1/2 t < Z \leq 2 t$										

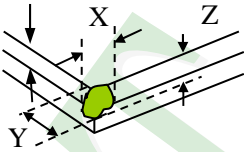
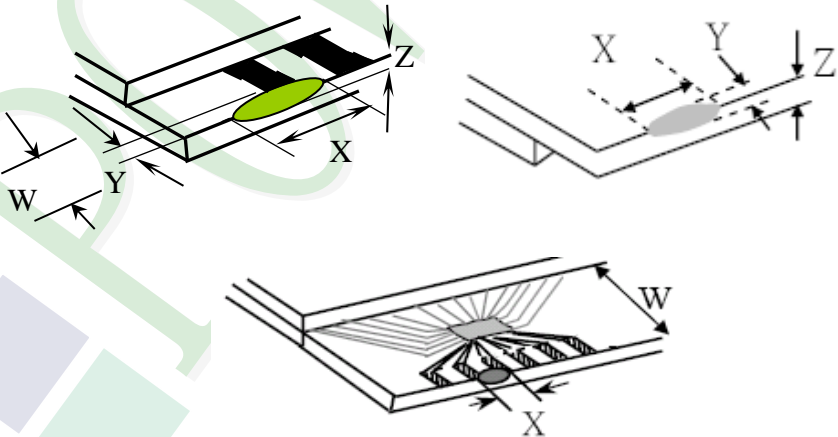
NO	Item	Criterion	Level												
08	The crack of glass	<p>Symbols :</p> <p>X: The length of crack Z: The thickness of crack t: The thickness of glass</p> <p>Y: The width of crack. W: terminal length a: LCD side length</p> <hr/> <p>8.1.2 Corner crack:</p>  <table border="1" data-bbox="520 763 1337 1055"> <thead> <tr> <th>X</th> <th>Y</th> <th>Z</th> </tr> </thead> <tbody> <tr> <td>$\leq 1/5 a$</td> <td>Crack can't enter viewing area</td> <td>$Z \leq 1/2 t$</td> </tr> <tr> <td>$\leq 1/5 a$</td> <td>Crack can't exceed the half of SP width.</td> <td>$1/2 t < Z \leq 2 t$</td> </tr> </tbody> </table>	X	Y	Z	$\leq 1/5 a$	Crack can't enter viewing area	$Z \leq 1/2 t$	$\leq 1/5 a$	Crack can't exceed the half of SP width.	$1/2 t < Z \leq 2 t$				
		X	Y	Z											
$\leq 1/5 a$	Crack can't enter viewing area	$Z \leq 1/2 t$													
$\leq 1/5 a$	Crack can't exceed the half of SP width.	$1/2 t < Z \leq 2 t$													
		<p>8.2 Protrusion over terminal:</p> <p>8.2.1 Chip on electrode pad:</p>  <table border="1" data-bbox="560 1697 1347 1872"> <thead> <tr> <th></th> <th>X</th> <th>Y</th> <th>Z</th> </tr> </thead> <tbody> <tr> <td>Front</td> <td>$\leq a$</td> <td>$\leq 1/2 W$</td> <td>$\leq t$</td> </tr> <tr> <td>Back</td> <td>$\leq a$</td> <td>$\leq W$</td> <td>$\leq 1/2 t$</td> </tr> </tbody> </table>		X	Y	Z	Front	$\leq a$	$\leq 1/2 W$	$\leq t$	Back	$\leq a$	$\leq W$	$\leq 1/2 t$	Minor
	X	Y	Z												
Front	$\leq a$	$\leq 1/2 W$	$\leq t$												
Back	$\leq a$	$\leq W$	$\leq 1/2 t$												

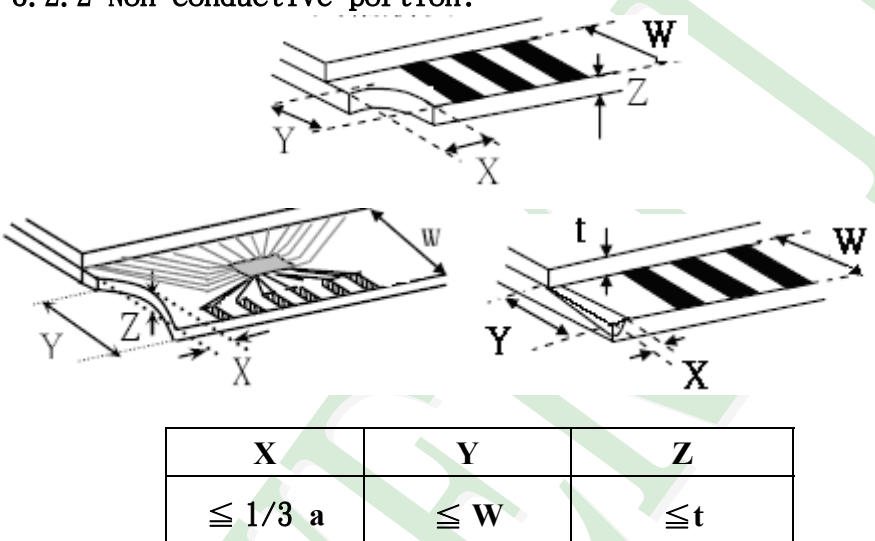
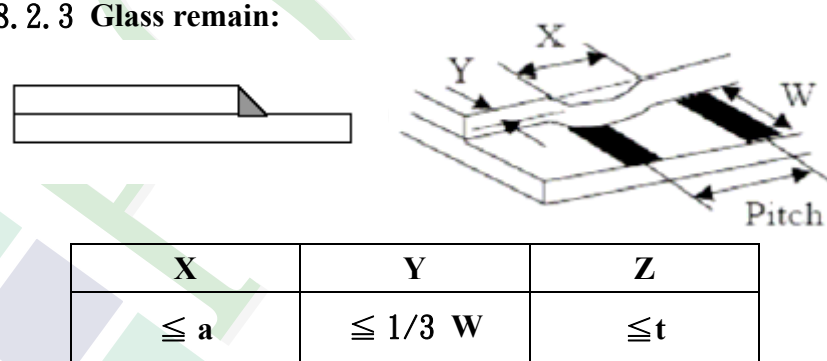
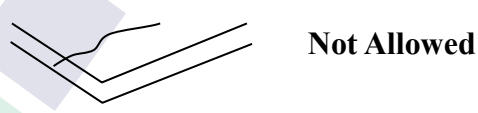
NO	Item	Criterion	Level												
08	The crack of glass	<p>Symbols:</p> <p>X: The length of crack Y: The width of crack. Z: The thickness of crack W: terminal length t: The thickness of glass a: LCD side length</p> <hr/> <p>8.2.2 Non-conductive portion:</p>  <table border="1" style="margin: 10px auto;"> <thead> <tr> <th>X</th> <th>Y</th> <th>Z</th> </tr> </thead> <tbody> <tr> <td>$\leq 1/3 a$</td> <td>$\leq W$</td> <td>$\leq t$</td> </tr> </tbody> </table> <p>⊙ If the chipped area touches the ITO terminal, over 2/3 of the ITO must remain and be inspected according to electrode terminal specifications.</p> <p>8.2.3 Glass remain:</p>  <table border="1" style="margin: 10px auto;"> <thead> <tr> <th>X</th> <th>Y</th> <th>Z</th> </tr> </thead> <tbody> <tr> <td>$\leq a$</td> <td>$\leq 1/3 W$</td> <td>$\leq t$</td> </tr> </tbody> </table> <p>8.2.4 Cracking:</p>  <p style="text-align: center;">Not Allowed</p>	X	Y	Z	$\leq 1/3 a$	$\leq W$	$\leq t$	X	Y	Z	$\leq a$	$\leq 1/3 W$	$\leq t$	Minor
X	Y	Z													
$\leq 1/3 a$	$\leq W$	$\leq t$													
X	Y	Z													
$\leq a$	$\leq 1/3 W$	$\leq t$													

◆Specification For TFT-LCD Module 3.5" ~15" :
(Ver.B01)

NO	Item	Criterion	Level
09	Backlight elements	9. 1 Backlight can't work normally.	Major
		9. 2 Backlight doesn't light or color is wrong.	Major
		9. 3 Illumination source flickers when lit.	Major
10	General appearance	10. 1 Pin type 、 quantity 、 dimension must match type in structure diagram.	Major
		10. 2 No short circuits in components on PCB or FPC.	Major
		10. 3 Parts on PCB or FPC must be: no wrong parts, missing parts or excess parts.	Major
		10. 4 Product packaging must the same as specified on packaging specification sheet.	Minor
		10. 5 The folding and peeled off in polarizer are not acceptable.	Minor
		10. 6 The PCB or FPC between B/L assembled distance(PCB or FPC) is ≤ 1.5 mm.	Minor

4. RELIABILITY TEST

4.1 Reliability Test Condition

(Ver.B01)

NO.	TEST ITEM	TEST CONDITION											
1	High Temperature Storage Test	Keep in $80 \pm 5^{\circ}\text{C}$ 240 hrs											
2	Low Temperature Storage Test	Keep in $-30 \pm 5^{\circ}\text{C}$ 240 hrs											
3	High Temperature / High Humidity Storage Test	Keep in 60°C / 90% R.H duration for 240 hrs (Excluding the polarizer)											
4	Temperature Cycling Storage Test	$ \begin{array}{ccccccc} & -30^{\circ}\text{C} & \rightarrow & +25^{\circ}\text{C} & \rightarrow & 80^{\circ}\text{C} & \rightarrow & +25^{\circ}\text{C} \\ & (30\text{mins}) & & (5\text{mins}) & & (30\text{mins}) & & (5\text{mins}) \\ & \longleftarrow & & & & & & \longrightarrow \\ & & & & & & & 20 \text{ Cycle} \end{array} $											
5	ESD Test	Air Discharge: Apply 2 KV with 5 times Discharge for each polarity +/-	Contact Discharge: Apply 250 V with 5 times discharge for each polarity +/-										
		1. Temperature ambience : $15^{\circ}\text{C} \sim 35^{\circ}\text{C}$ 2. Humidity relative : $30\% \sim 60\%$ 3. Energy Storage Capacitance(Cs+Cd) : $150\text{pF} \pm 10\%$ 4. Discharge Resistance(Rd) : $330\Omega \pm 10\%$ 5. Discharge, mode of operation : Single Discharge (time between successive discharges at least 1 sec) (Tolerance if the output voltage indication : $\pm 5\%$)											
6	Vibration Test (Packaged)	1. Sine wave $10 \sim 55$ Hz frequency (1 min/sweep) 2. The amplitude of vibration : 1.5 mm 3. Each direction (X、Y、Z) duration for 2 Hrs											
7	Drop Test (Packaged)	<table border="1"> <thead> <tr> <th>Packing Weight (Kg)</th> <th>Drop Height (cm)</th> </tr> </thead> <tbody> <tr> <td>0 ~ 45.4</td> <td>122</td> </tr> <tr> <td>45.4 ~ 90.8</td> <td>76</td> </tr> <tr> <td>90.8 ~ 454</td> <td>61</td> </tr> <tr> <td>Over 454</td> <td>46</td> </tr> </tbody> </table>		Packing Weight (Kg)	Drop Height (cm)	0 ~ 45.4	122	45.4 ~ 90.8	76	90.8 ~ 454	61	Over 454	46
		Packing Weight (Kg)	Drop Height (cm)										
0 ~ 45.4	122												
45.4 ~ 90.8	76												
90.8 ~ 454	61												
Over 454	46												
		Drop Direction : ※1 corner / 3 edges / 6 sides each 1time											

◎Result Evaluation Criteria :

Under the display quality test conditions with normal operations with normal operation state.
 Do not change these conditions as such changes may affect practical display function.
 (Normal operation state)

Temperature : $+20 \sim 30^{\circ}\text{C}$

Humidity : $50 \sim 70\%$

Atmospheric pressure : $86 \sim 106\text{Kpa}$

5. PRECAUTION RELATING PRODUCT HANDLING

5.1 SAFETY

- 5.1.1 If the LCD panel breaks , be careful not to get the liquid crystal to touch your skin.
- 5.1.2 If the liquid crystal touches your skin or clothes , please wash it off immediately by using soap and water.

5.2 HANDLING

- 5.2.1 Avoid any strong mechanical shock which can break the glass.
- 5.2.2 Avoid static electricity which can damage the CMOS LSI—When working with the module , be sure to ground your body and any electrical equipment you may be using.
- 5.2.3 Do not remove the panel or frame from the module.
- 5.2.4 The polarizing plate of the display is very fragile. So , please handle it very carefully, do not touch , push or rub the exposed polarizing with anything harder than an HB pencil lead (glass , tweezers , etc.)
- 5.2.5 Do not wipe the polarizing plate with a dry cloth , as it may easily scratch the surface of plate.
- 5.2.6 Do not touch the display area with bare hands , this will stain the display area.
- 5.2.7 Do not use ketonics solvent & aromatic solvent. Use with a soft cloth soaked with a cleaning naphtha solvent.
- 5.2.8 To control temperature and time of soldering is $320 \pm 10^{\circ}\text{C}$ and 3-5 sec.
- 5.2.9 To avoid liquid (include organic solvent) stained on LCM
- 5.2.10 Caution! (LCM products with Capacitive Touch Panel)
 - Strong EMI-sources such as switch-mode power supplies (SMPS) can lead to touch malfunction (e.g. ghost-touches).
 - Therefore, the touch needs to be thoroughly tested inside the target application.
- 5.2.11 Caution: Continuously displaying same static image will result in high possibility of image sticking/image burn-in effect due to TFT panel characteristic.

5.3 STORAGE

- 5.3.1 Store the panel or module in a dark place where the temperature is $25^{\circ}\text{C} \pm 5^{\circ}\text{C}$ and the humidity is below 65% RH.
- 5.3.2 Do not place the module near organics solvents or corrosive gases.
- 5.3.3 Do not crush , shake , or jolt the module.

5.4 TERMS OF WARRANTY

- 5.4.1 Applicable warrant period
 - The period is within thirteen months since the date of shipping out under normal using and storage conditions.
- 5.4.2 Unaccepted responsibility
 - This product has been manufactured to your company's specification as a part for use in your company's general electronic products. It is guaranteed to perform according to delivery specifications. For any other use apart from general electronic equipment, we cannot take responsibility if the product is used in nuclear power control equipment, aerospace equipment , fire and security systems or any other applications in which there is a direct risk to human life and where extremely

A

B

C

D

E

F

G

H

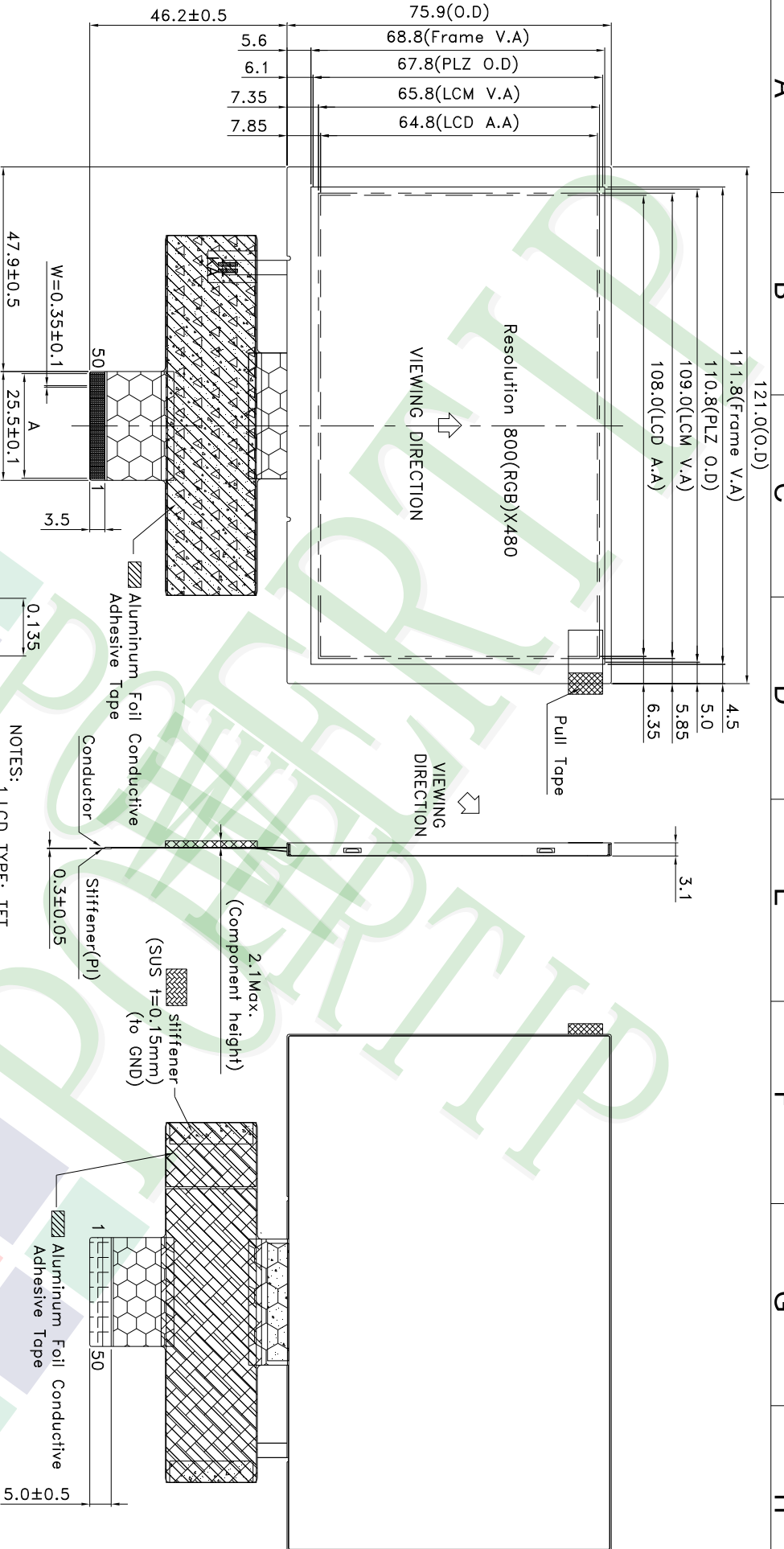

PART NO.: PH800480T33-IHA

DRAWING NAME: LMD-PH800480T33-IHA

久正光电股份有限公司
POWER TIP TECHNOLOGY CORPORATION

Design Kevin Lin

Check Clare

Approve Rex

Surface (3)

Material

Tolerance (mm)

Precision Level

TITLE: LCD MODULE DRAWING

Design

Kevin Lin

Check Clare

Approve Rex

Unit

Material

Tolerance (mm)

Precision Level

DATE: 2020/04/08

Design

Kevin Lin

Check Clare

Approve Rex

Unit

Material

Tolerance (mm)

Precision Level

DATE: 2020/04/08

Design

Kevin Lin

Check Clare

Approve Rex

Unit

Material

Tolerance (mm)

Precision Level

DATE: 2020/04/08

Design

Kevin Lin

Check Clare

Approve Rex

Unit

Material

Tolerance (mm)

Precision Level

DATE: 2020/04/08

Design

Kevin Lin

Check Clare

Approve Rex

Unit

Material

Tolerance (mm)

Precision Level

REV: NEW DRAWING

REV BY: Kevin Lin

REVISER: Kevin Lin

DATE: 2020/04/08

DATE: 2020/04/08

Design

Kevin Lin

Check Clare

Approve Rex

Unit

Material

Tolerance (mm)

Precision Level

PT-A-054-01

1. 包裝材料規格表 (Packaging Material) : (per carton)

No.	Item	Model	Dimensions (mm)	1Pcs Weight	Quantity	Total Weight
1	成品 (LCM)	PH800480T033-IHA	121.0 X 75.9	0.059	3600	212.4
2	多層薄膜(1)POF	OTFILM0BA03ABA	19"X350X0.015	—	1050	—
3	舒美墊(3) EPE	FOAM000000180	130.0 X 90.0 X 1	0.0002	3600	0.72
4	TRAY 盤 (2)Tray	TYSG000000187	352 X 260 X 12.8	0.0965	1050	101.325
5	舒美墊(4) EPE	FOAM000000047	350 X 255 X 5	0.011	150	1.65
6	內盒(3)Product Box	BX36627063ABBA	383 X 270 X 66	0.182	150	27.3
7	保利龍板(5)Polylon board	OTPLB00PL08ABA	550 X 393 X 20	0.0284	50	1.42
8	外紙箱(6)Carton	BX57041027CCBA	570 X 410 X 265	1.0	25	25.0
9	棧板(7)PALLET	OTPALLET005ABA	1200 X 1000 X 145	8	1	8

2. 總重量 (Total Weight) : 377.82 Kg±10%

3. 單箱數量規格表 (Packaging Specifications and Quantity) :

(1) LCM quantity per box : no per tray	4	x no of tray	6	=	24
(2) Total LCM quantity in carton : quantity per box	24	x no of boxes	6	=	144
(3) Total LCM quantity in pallet : quantity per carton	144	x no. of cartons	25	=	3600

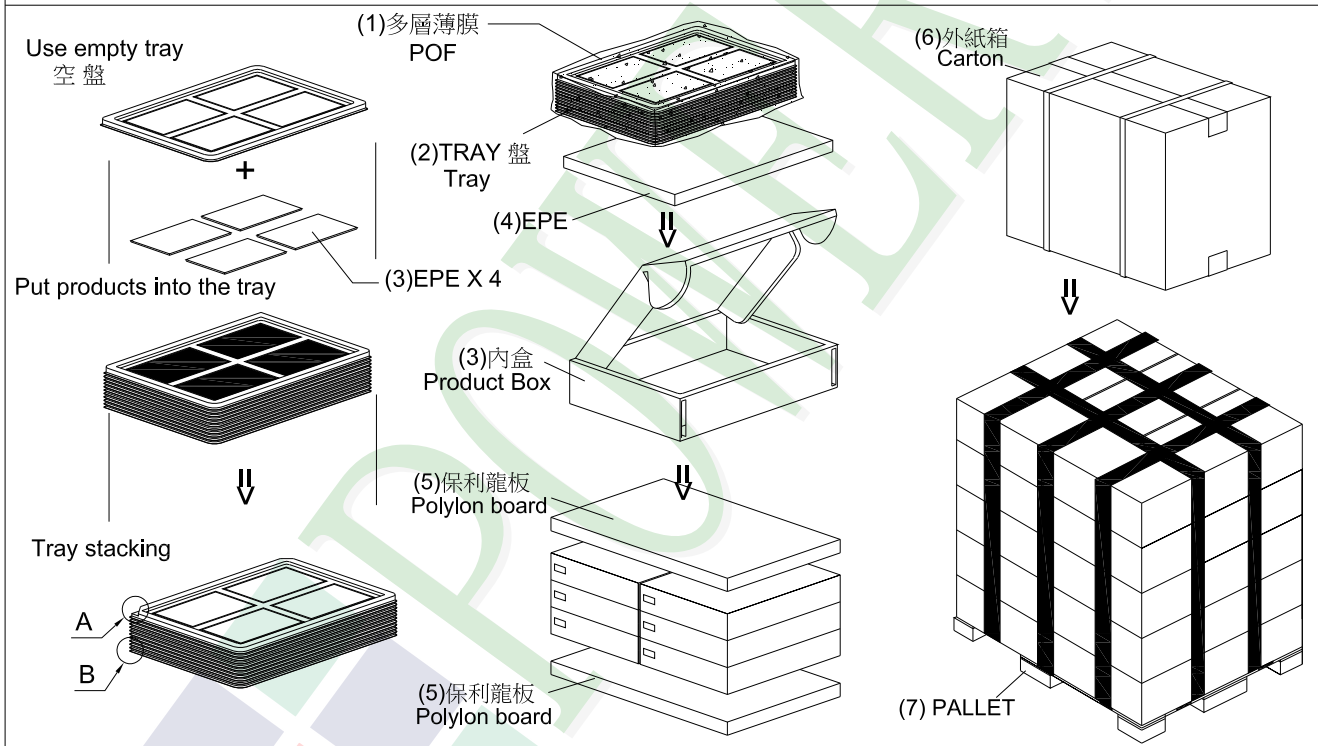

特記事項 (REMARK)

<p>4. TRAY 盤相疊時, 需旋轉 180 度, 請詳見 B 視圖 Rotate tray 180 degrees and place on top of stack. Check the tray stack using Fig. B.</p>	<p>5. 外購 Tray: TY00000000308 自製 Tray: TYSG000000187</p>	
--	---	--

X-ON Electronics

Largest Supplier of Electrical and Electronic Components

Click to view similar products for [TFT Displays & Accessories category](#):

Click to view products by [Powertip manufacturer](#):

Other Similar products are found below :

[OAI-80038AA-2013-A](#) [HDA430T-3G1H](#) [NB-ATT01](#) [TCG104SVLQAPNN-AN20](#) [OAI-80038AA-2008-A](#) [315-U004B15300](#) [EIC-LCD-1080P](#) [NL10276BC20-18C](#) [DEM 128160D](#) [TMH-PW-N](#) [RFE43BU-AIW-DNG](#) [EA WF050-40S](#) [EA WF050-40ST](#) [RFC350X-AWW-DNG](#) [RFS390E-AWW-DNN](#) [DEM 480272G2](#) [VMX-PW-N \(A-TOUCH\)](#) [PH800480T013-ICA](#) [DEM 1024600N](#) [VMX-PW-N \(C-TOUCH\)](#) [DEM 1024600P](#) [VMH-PW-N \(C-TOUCH\)](#) [SM-RVT50HQHNWCA0](#) [DEM 240280A](#) [VMH-PW-N](#) [DEM 170320A](#) [VMH-PW-N](#) [PH240320T068-LAB08](#) [DEM 800480T1](#) [TMH-PW-N](#) [PH128128T041-LAA07](#) [PH480272T005-IAC02](#) [DEM 1024600P](#) [VMH-PW-N \(A-TOUCH\)](#) [DEM 800480T1](#) [TMH-PW-N \(C-TOUCH\)](#) [DEM 800480Q4](#) [VMX-PW-N](#) [DEM 800480T1](#) [TMH-PW-N \(A-TOUCH\)](#) [PH320240T-023-I02Q](#) [PH128800T004-ZZA01](#) [RFE430W-1YW-DBS](#) [DEM 1024600N](#) [VMX-PW-N \(A-TOUCH\)](#) [PH240320T074-ZAA01](#) [DEM 480480D](#) [VMX-PW-N \(C-TOUCH\)](#) [SM-RVT50HQSNWN00](#) [SM-RVT50HQHNWC00](#) [PH800480T033-ICB01](#) [RFE430W-AWW-DNN](#) [DEM 096096A](#) [VMH-PW-N](#) [RL0F00050000FGAAASA01](#) [SM-RVT50HQSNWCA0](#) [SM-RVT50HQSNWC00-B](#) [PH320240T028-ZEA01](#) [RFE430W-1YW-DBN](#) [SM-RVT50HQHNWC00-B](#) [DEM 120240A](#) [VMH-PW-N](#) [DEM 268800A](#) [VMH-PW-N](#) [RFF700B4-AIW-DNS](#) [DEM 800480O1](#) [VMH-PW-N](#)