

Description

The PESDUC2XD3V3BF protects sensitive semiconductor components from damage or upset due to electrostatic discharge (ESD) and other voltage induced transient events. They feature large cross-sectional area junctions for conducting high transient currents, offer desirable electrical characteristics for board level protection, such as fast response time, low operating voltage. It gives designer the flexibility to protect one unidirectional line in applications where arrays are not practical.

Feature

- DFN0603-2L package
- Replacement for MLV(0201)
- Bidirectional configurations
- Response time is typically < 1 ns
- Low clamping voltage
- RoHS compliant
- Transient protection for data lines to
IEC 61000-4-2(ESD) $\pm 25\text{kV}$ (air), $\pm 25\text{kV}$ (contact);
IEC 61000-4-4 (EFT) 40A (5/50ns)

Applications

- Cellular phones
- Portable devices
- Digital cameras
- Power supplies

Mechanical Characteristics

- Mounting position: Any
- Qualified max reflow temperature: 260°C
- Device meets MSL 1 requirements
- DFN0603-2L without plating



DFN0603-2L(Bottom View)

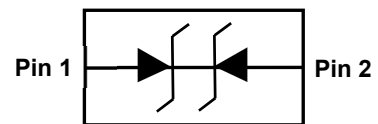

Circuit Diagram



Marking (Top View)

Electronics Parameter

Symbol	Parameter
V_{RWM}	Peak Reverse Working Voltage
I_R	Reverse Leakage Current @ V_{RWM}
V_{BR}	Breakdown Voltage @ I_T
I_T	Test Current
I_{PP}	Maximum Reverse Peak Pulse Current
V_C	Clamping Voltage @ I_{PP}
P_{PP}	Peak Pulse Power
C_J	Junction Capacitance
I_F	Forward Current
V_F	Forward Voltage @ I_F

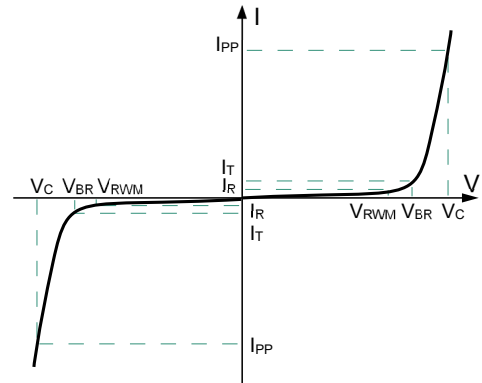

Electrical characteristics per line@25°C (unless otherwise specified)

Parameter	Symbol	Conditions	Min.	Typ.	Max.	Units
Peak Reverse Working Voltage	V_{RWM}				3.3	V
Breakdown Voltage	V_{BR}	$I_T = 1\text{mA}$	4.8			V
Reverse Leakage Current	I_R	$V_{RWM} = 3.3\text{V}$ $T=25^\circ\text{C}$			1	μA
Clamping Voltage ¹⁾	V_C	TLP = 16A $t_P = 100\text{ns}$		24		V
Dynamic Resistance ¹⁾	R_{DYN}			0.9		Ω
Clamping Voltage ²⁾	V_C	$I_{PP} = 1\text{A}$ $t_P = 8/20\mu\text{s}$		9.5	11	V
Clamping Voltage ²⁾	V_C	$I_{PP} = 5\text{A}$ $t_P = 8/20\mu\text{s}$		19	21	V
Junction Capacitance	C_j	$V_R=0\text{V}$ $f = 1\text{MHz}$		0.25	0.35	pF

Notes:

- 1) TLP parameter: $Z_0=50\Omega$, $t_p=100\text{ns}$, $t_r=2\text{ns}$, averaging window from 60ns to 80ns. R_{DYN} is calculated from 4A to 16A.
- 2) Non-repetitive current pulse, according to IEC61000-4-5.

Absolute maximum rating@25°C

Rating	Symbol	Value	Units
Peak Pulse Power ($t_p=8/20 \mu\text{s}$)	P_{PP}	90	W
Peak Pulse Current ($t_p=8/20 \mu\text{s}$)	I_{PP}	5	A
Operating Temperature	T_J	-55 to 150	$^\circ\text{C}$
Storage Temperature	T_{STG}	-55 to 150	$^\circ\text{C}$
ESD Protection-Contact Discharge	V_{ESD}	± 25	kV
ESD Protection-Air Discharge	V_{ESD}	± 25	kV

Typical Characteristics

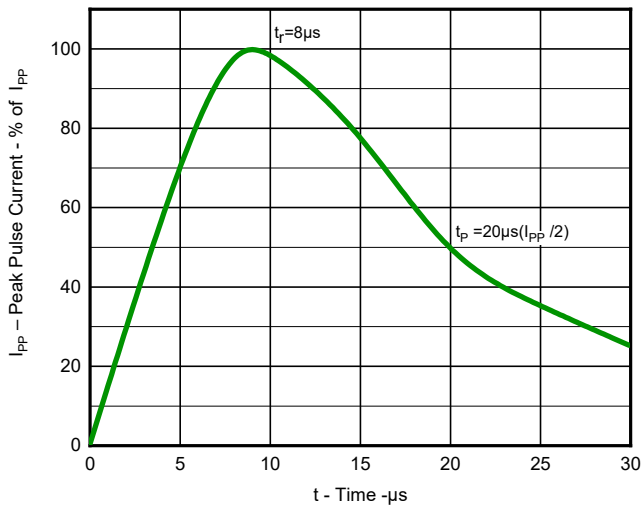

Fig 1. Pulse Waveform(8/20 μs)

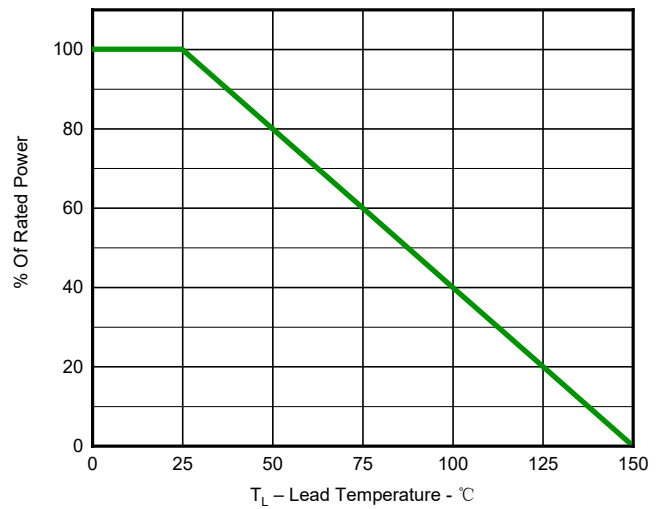

Fig 2. Power Derating Curve

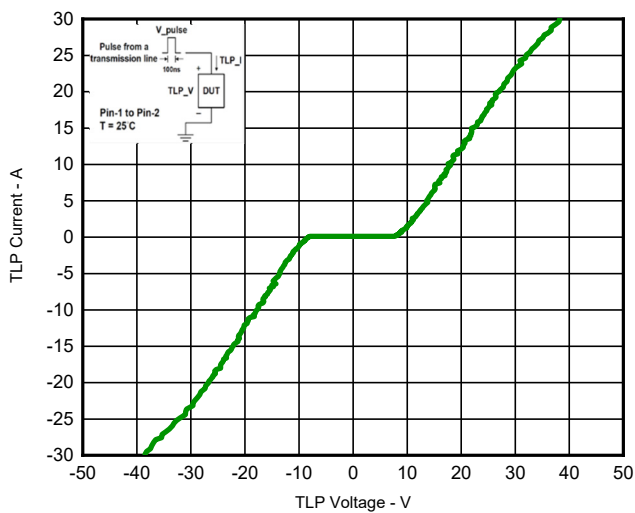

Fig 3. TLP Measurement

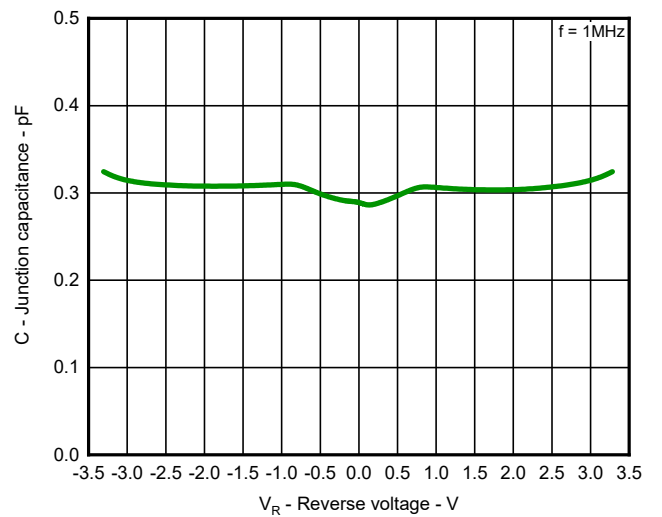

Fig 4. Capacitance vs. Reverse voltage

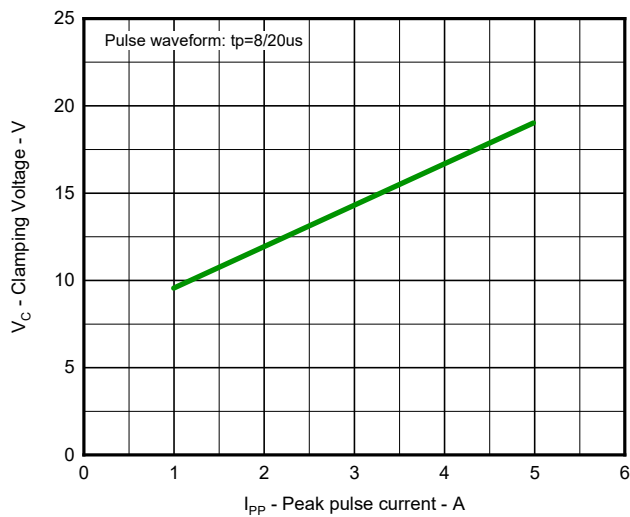

Fig 5. Clamping voltage vs. Peak pulse current

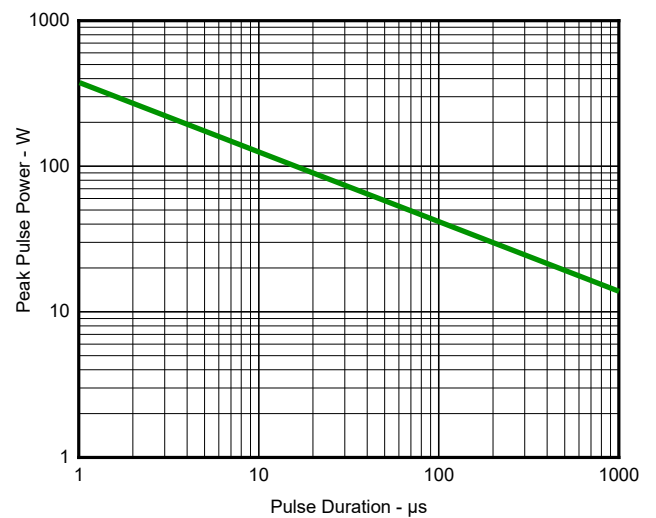

Fig 6. Non Repetitive Peak Pulse Power vs. Pulse time

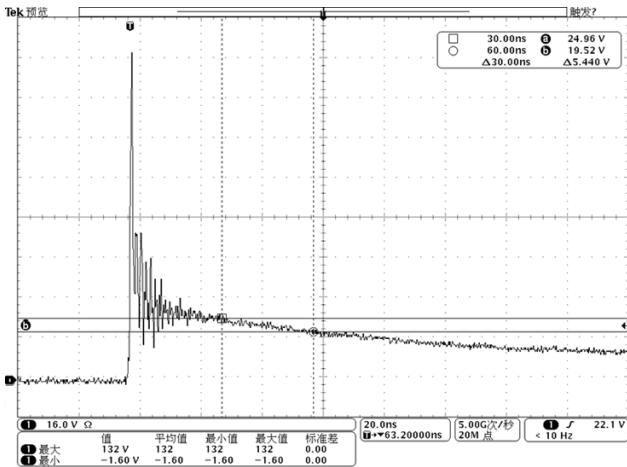

Fig 7.ESD Clamping voltage (IEC61000-4-2 +8kV contact)

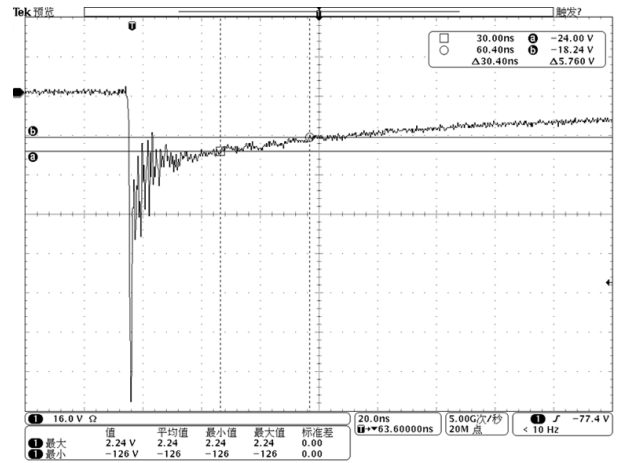
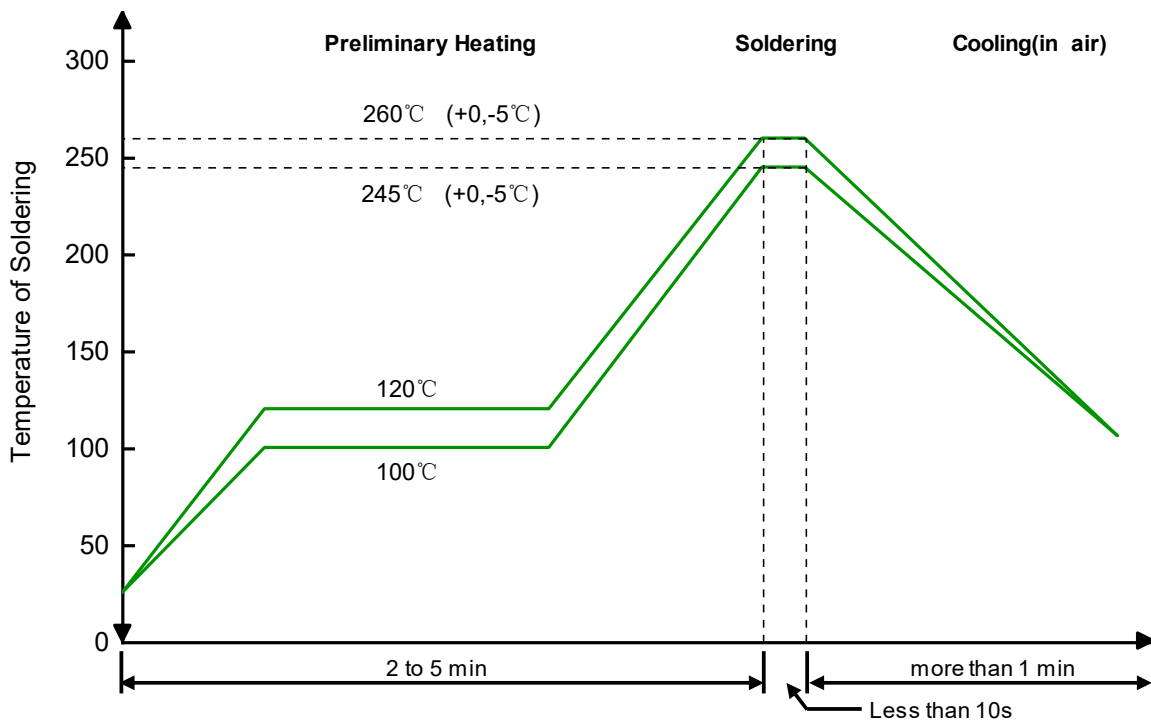

Fig 8.ESD Clamping voltage (IEC61000-4-2 -8kV contact)

Solder Reflow Recommendation



Remark: Pb free for 260°C; Pb for 245°C.

PCB Design

For TVS diodes a low-ohmic and low-inductive path to chassis earth is absolutely mandatory in order to achieve good ESD protection. Novices in the area of ESD protection should take following suggestions to heart:

- Do not use stubs, but place the cathode of the TVS diode directly on the signal trace.
- Do not make false economies and save copper for the ground connection.
- Place via holes to ground as close as possible to the anode of the TVS diode.
- Use as many via holes as possible for the ground connection.
- Keep the length of via holes in mind! The longer the more inductance they will have.

Product dimension (DFN0603-2L)

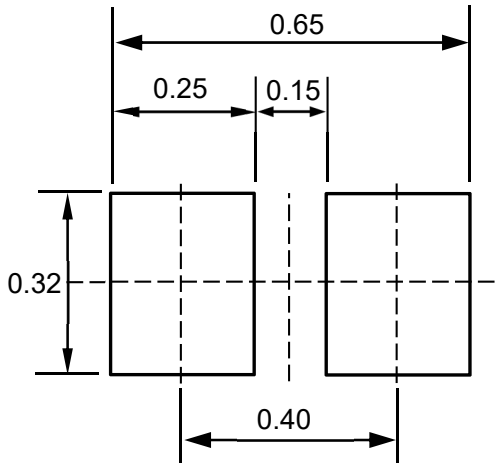
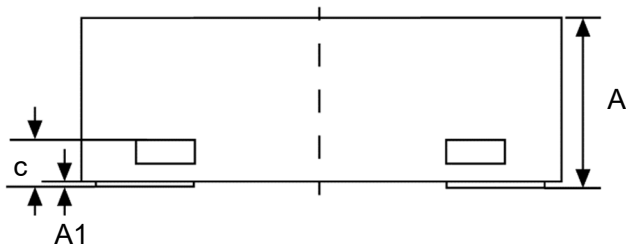
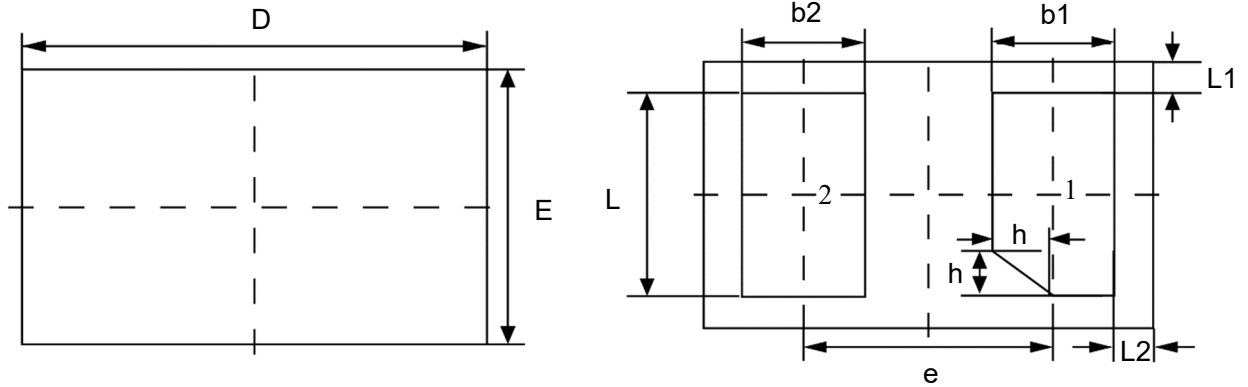

Dim	Millimeters		
	MIN	Typ.	MAX
A	0.28	0.30	0.35
A1	0	0.02	0.05
b1	0.13	0.18	0.23
b2	0.14	0.19	0.24
c	0.05	0.1	0.15
D	0.55	0.60	0.65
e	0.35BSC		
L1	0.025BSC		
L2	0.035BSC		
E	0.25	0.30	0.35
L	0.20	0.25	0.30
h	0	0.05	0.10

Unit:mm

Suggested PCB Layout

Ordering information

Device	Package	Reel	Shipping
PESDUC2XD3V3BF	DFN0603-2L (Pb-Free)	7"	12000 / Tape & Reel

Load with information

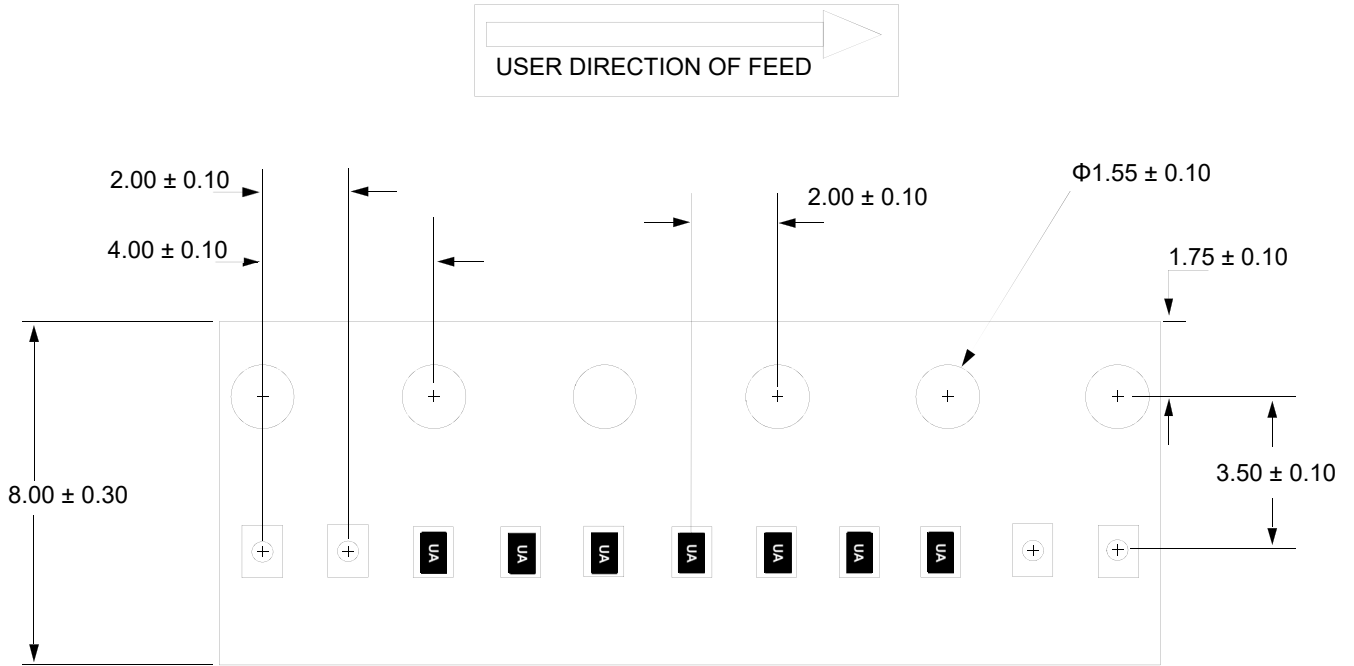

Unit: mm

IMPORTANT NOTICE

 and **Prisemi**[®] are registered trademarks of **Prisemi Electronics Co., Ltd** (Prisemi). Prisemi reserves the right to make changes without further notice to any products herein. Prisemi makes no warranty, representation or guarantee regarding the suitability of its products for any particular purpose, nor does Prisemi assume any liability arising out of the application or use of any product or circuit, and specifically disclaims any and all liability, including without limitation special, consequential or incidental damages. "Typical" parameters which may be provided in Prisemi data sheets and/or specifications can and do vary in different applications and actual performance may vary over time. All operating parameters, including "Typicals" must be validated for each customer application by customer's technical experts. Prisemi does not convey any license under its patent rights nor the rights of others. The products listed in this document are designed to be used with ordinary electronic equipment or devices, Should you intend to use these products with equipment or devices which require an extremely high level of reliability and the malfunction of which would directly endanger human life (such as medical instruments, aerospace machinery, nuclear-reactor controllers, fuel controllers and other safety devices), please be sure to consult with our sales representative in advance.

Website: <http://www.prisemi.com>

For additional information, please contact your local Sales Representative.

©Copyright 2009, Prisemi Electronics

 **Prisemi**[®] is a registered trademark of Prisemi Electronics.

All rights are reserved.

X-ON Electronics

Largest Supplier of Electrical and Electronic Components

Click to view similar products for [ESD Suppressors / TVS Diodes](#) category:

Click to view products by [Prisemi](#) manufacturer:

Other Similar products are found below :

[NTE4902](#) [P4SMAJ15A](#) [P4SMAJ26A](#) [SMAJ400CA-TP](#) [TGL34-47CA](#) [ESDAULC45-1BF4](#) [SM1605E3/TR13](#) [SMF20A-TP](#) [P4SMAJ12A](#)
[CPDUR24V-HF](#) [CPDQC5V0USP-HF](#) [CPDQC5V0-HF](#) [MPLAD30KP280A](#) [MPLAD30KP45CAE3](#) [MMBZ27VCLQ-7-F](#) [MMAD1108/TR13](#)
[MPLAD30KP24A](#) [MPLAD30KP30CAE3](#) [ACPDQC5V0R-HF](#) [DFLT170A-7](#) [NTE4900](#) [NTE4926](#) [NTE4938](#) [JANTX1N6144A](#)
[JANTX1N6057A](#) [SMF22A-TP](#) [SMF12A-TP](#) [SLVU2.8-TP](#) [SMLJ6.5CA-TP](#) [SMAJ6.5CA-TP](#) [MMAD1108E3/TR13](#) [JANTX1N6160A](#)
[D5V0M1U2LP3-7](#) [SMAJ400A-TP](#) [AOZ8811DT-03](#) [AOZ8831DI-05](#) [AOZ8831DT-03](#) [SMAJ188CA](#) [3SMC33CA BK](#) [CPDQC3V3C-HF](#)
[CPDQC12VE-HF](#) [GRPADATAJANTX1N6041A](#) [MPLAD30KP170CA](#) [82357120100](#) [5.0SMLJ15CA-TP](#) [5KP18A-TP](#) [P6KE8.2A-TP](#)
[MPLAD30KP43CAE3](#) [SMAJ43A-TP](#) [D26V0H1U2LP16-7](#)