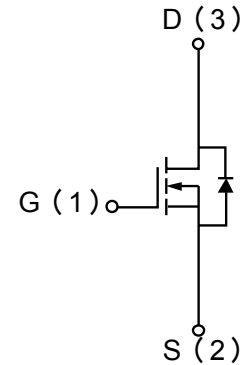

**Description**

The MOSFET provide the best combination of fast switching, low on-resistance and cost-effectiveness.

MOSFET Product Summary		
V <sub>DS</sub> (V)	R <sub>DS(on)</sub> (Ω)	I <sub>D</sub> (A)
20	0.043@ V <sub>GS</sub> =4.5V	3

**Electrical characteristics per line@25°C ( unless otherwise specified)**

Parameter	Symbol	Conditions	Min.	Typ.	Max.	Units
<b>OFF/ON CHARACTERISTICS</b>						
Drain-Source Breakdown Voltage	BV <sub>DSS</sub>	I <sub>D</sub> =250μA, V <sub>GS</sub> =0V	20		-	V
Zero Gate Voltage Drain Current	I <sub>DSS</sub>	V <sub>DS</sub> =20V, V <sub>GS</sub> =0V	-	-	1	μA
Gate-Body Leakage Current	I <sub>GSS</sub>	V <sub>DS</sub> =0V, V <sub>GS</sub> =±8V	-	-	±100	nA
Gate Threshold Voltage	V <sub>GS(th)</sub>	V <sub>DS</sub> =V <sub>GS</sub> , I <sub>D</sub> =250μA	0.6	-	1.2	V
Static Drain-Source On-Resistance <sup>2</sup>	R <sub>DS(ON)</sub>	V <sub>GS</sub> =4.5V, I <sub>D</sub> =2.8A	-	0.043	0.060	Ω
		V <sub>GS</sub> =2.5V, I <sub>D</sub> =2.0A	-	0.052	0.115	Ω
<b>DYNAMIC PARAMETERS</b>						
Input Capacitance	C <sub>ISS</sub>	V <sub>GS</sub> =0V, V <sub>DS</sub> =10V, f=1MHz	-	450		pF
Output Capacitance	C <sub>OSS</sub>		-	70		pF
Reverse Transfer Capacitance	C <sub>RSS</sub>		-	43		pF
<b>SWITCHING PARAMETERS</b>						
Turn-On Delay Time	t <sub>d(on)</sub>	V <sub>DS</sub> =10V, V <sub>GS</sub> =4.5V, R <sub>G</sub> =6Ω, I <sub>D</sub> =1A	-	7	15	ns
Turn-Off Delay Time	t <sub>d(off)</sub>		-	16	60	ns
Turn-On Rise Time	Tr		-	55	80	ns
Turn-On Fall Time	Tf		-	20	25	ns
Total Gate Charge	Qg(10)	V <sub>DS</sub> =10V, V <sub>GS</sub> =4.5V, I <sub>D</sub> =3.6A		5.2	10	nC
Gate-Source Charge	Qgs			0.65		nC
Gate-Drain Charge	Qgd			1.5		nC
Drain-Source Diode Forward Voltage	V <sub>SD</sub>	V <sub>GS</sub> =0V, I <sub>S</sub> =1.0A		0.76	1.2	V
Maximum Continuous rain-Source Diode Forward Current	I <sub>S</sub>				1.6	A

Absolute maximum rating@25°C

Parameter		Symbol	Value	Units	
Drain-Source Voltage		$V_{DS}$	20	V	
Gate-Source Voltage		$V_{GS}$	±8	V	
Drain Current	Continuous	$I_D$	3	A	
	Pulsed	$I_D$	9	A	
Total Power Dissipation		$P_D$	1.25	W	
Operating Junction Temperature Range		$T_J$	-55 to 150	°C	
Thermal Characteristics					
Parameter		Symbol	Typ	Max	Units
Maximum Junction-to-Ambient A	t≤10s	$\theta_{JA}$	-	100	°C/W

Typical Characteristics

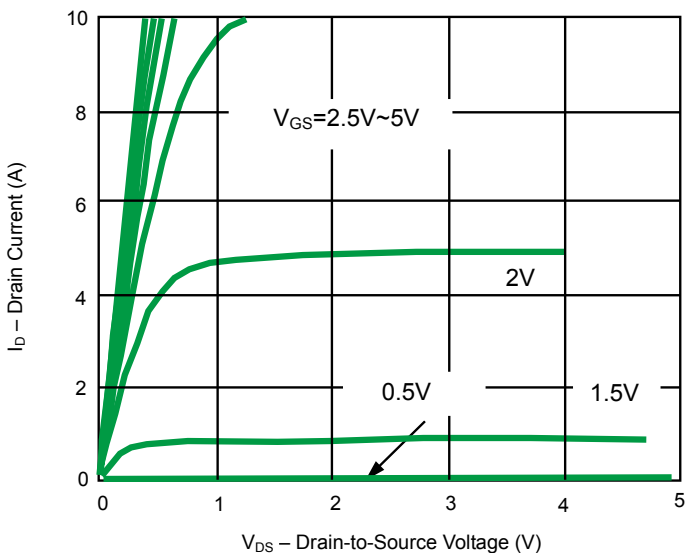

Fig 1. Output Characteristics

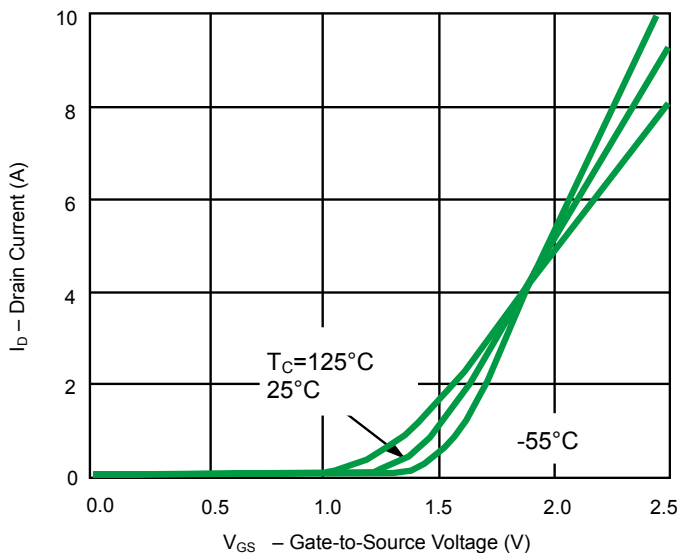

Fig 2. Transfer Characteristics

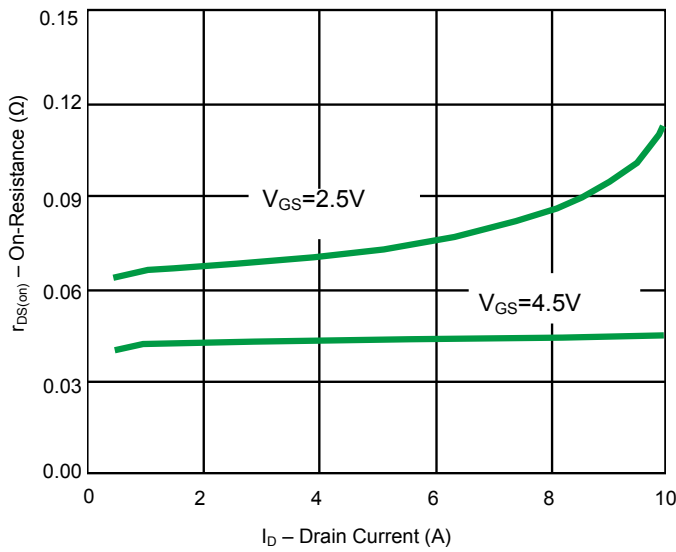

Fig 3. On-Resistance vs. Drain Current

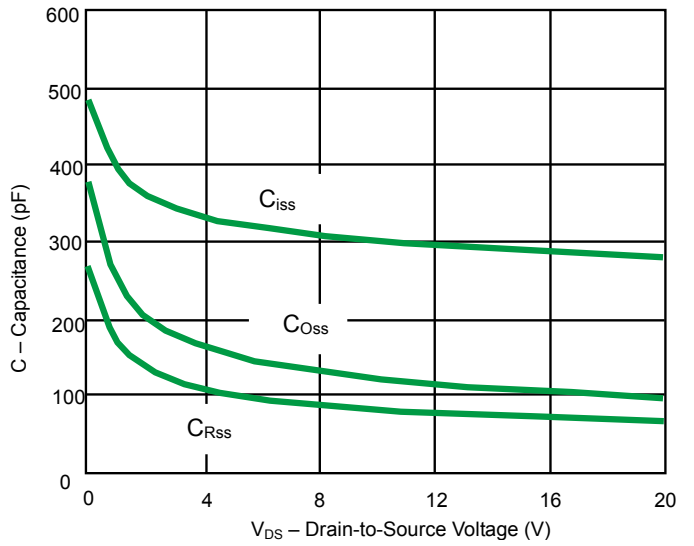

Fig 4. Capacitance Characteristics

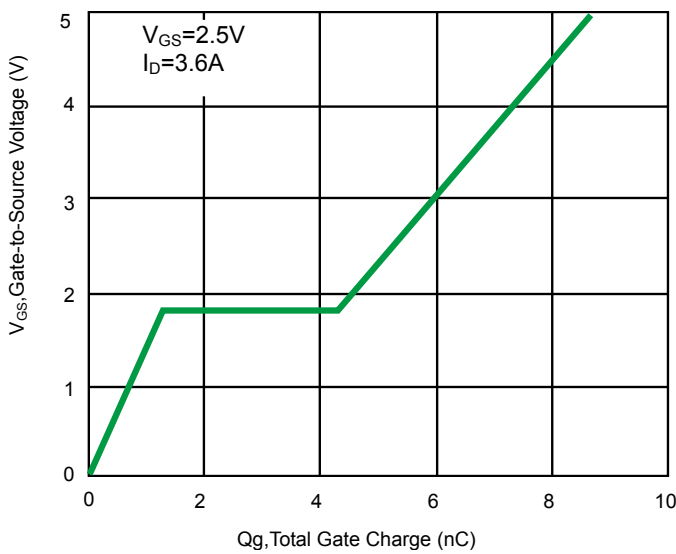

Fig 5. Gate Charge Characteristics

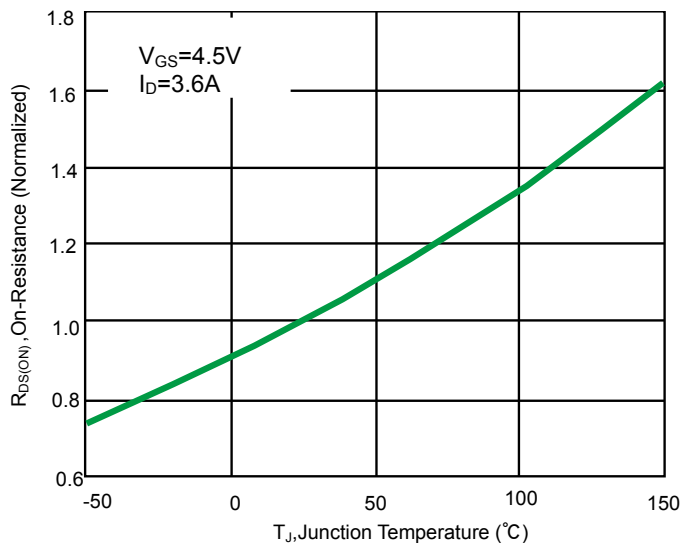

Fig 6. On-Resistance vs. Junction Temperature

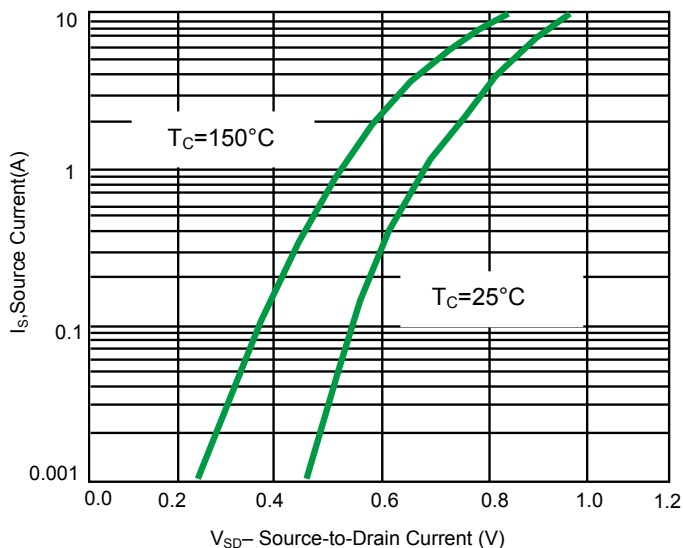

Fig 7. Source-Drain Diode Forward Voltage

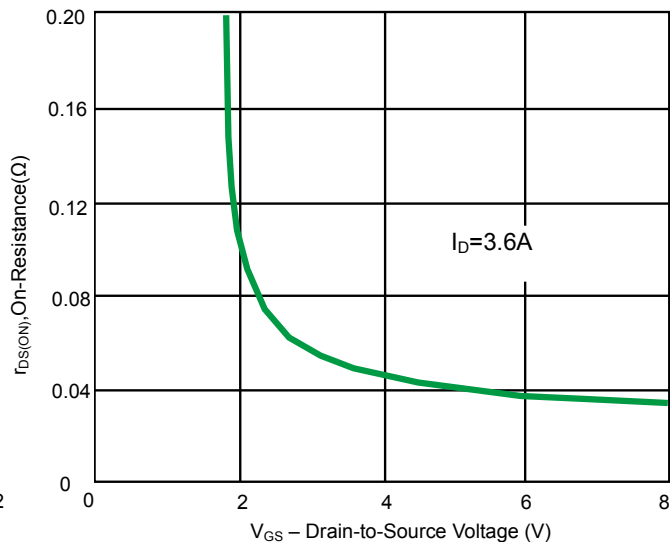

Fig 8. On-Resistance vs. Gate-to-Source Voltage

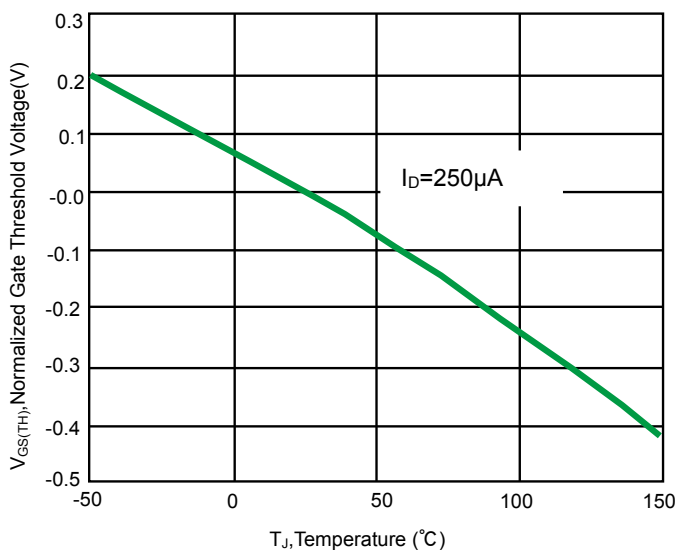

Fig 9. Normalized Gate Threshold Voltage vs. Temperature

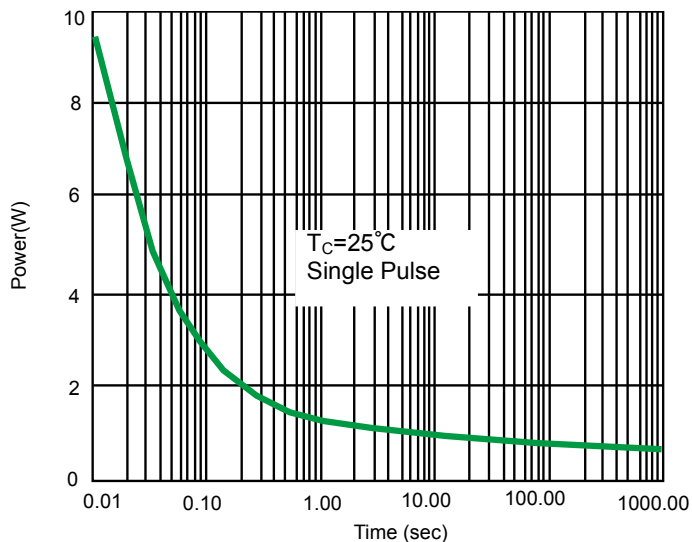
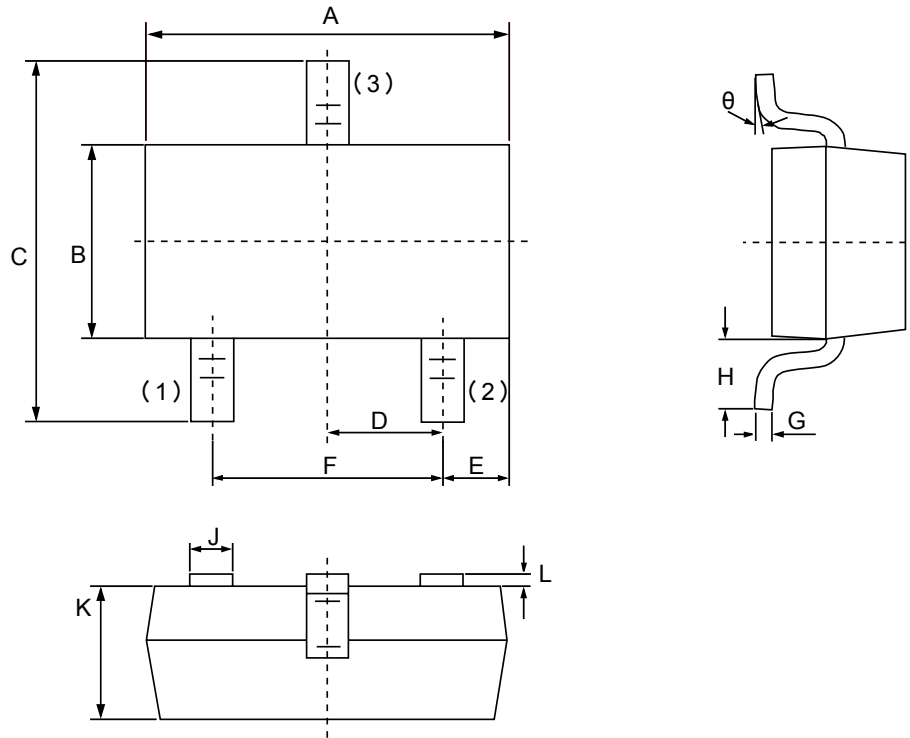



Fig 10. Single Pulse Power

Product dimension(SOT-23)



Dim	Millimeters		Inches	
	MIN	MAX	MIN	MAX
A	2.80	3.00	0.1102	0.1197
B	1.20	1.40	0.0472	0.0551
C	2.10	2.50	0.0830	0.0984
D	0.89	1.02	0.0350	0.0401
E	0.45	0.60	0.0177	0.0236
F	1.78	2.04	0.0701	0.0807
G	0.085	0.177	0.0034	0.0070
H	0.45	0.60	0.0180	0.0236
J	0.37	0.50	0.0150	0.0200
K	0.89	1.11	0.0350	0.0440
L	0.013	0.100	0.0005	0.0040
θ	0°	10°	0°	10°

**IMPORTANT NOTICE**

 and **Prisemi**<sup>®</sup> are registered trademarks of **Prisemi Electronics Co., Ltd (Prisemi)** ,Prisemi reserves the right to make changes without further notice to any products herein. Prisemi makes no warranty, representation or guarantee regarding the suitability of its products for any particular purpose, nor does Prisemi assume any liability arising out of the application or use of any product or circuit, and specifically disclaims any and all liability, including without limitation special, consequential or incidental damages. “Typical” parameters which may be provided in Prisemi data sheets and/or specifications can and do vary in different applications and actual performance may vary over time. All operating parameters, including “Typicals” must be validated for each customer application by customer’s technical experts. Prisemi does not convey any license under its patent rights nor the rights of others. The products listed in this document are designed to be used with ordinary electronic equipment or devices, Should you intend to use these products with equipment or devices which require an extremely high level of reliability and the malfunction of with would directly endanger human life (such as medical instruments, aerospace machinery, nuclear-reactor controllers, fuel controllers and other safety devices), please be sure to consult with our sales representative in advance.

Website: <http://www.prisemi.com>

For additional information, please contact your local Sales Representative.

©Copyright 2009, Prisemi Electronics

 **Prisemi**<sup>®</sup> is a registered trademark of Prisemi Electronics.

All rights are reserved.

## X-ON Electronics

Largest Supplier of Electrical and Electronic Components

*Click to view similar products for [MOSFET](#) category:*

*Click to view products by [Prisemi](#) manufacturer:*

Other Similar products are found below :

[614233C](#) [648584F](#) [IRFD120](#) [IRFF430](#) [JANTX2N5237](#) [2N7000](#) [FCA20N60\\_F109](#) [FDZ595PZ](#) [2SK2267\(Q\)](#) [2SK2545\(Q,T\)](#) [405094E](#)  
[423220D](#) [MIC4420CM-TR](#) [VN1206L](#) [614234A](#) [715780A](#) [SSM6J414TU,LF\(T](#) [751625C](#) [PSMN4R2-30MLD](#) [TK31J60W5,S1VQ\(O](#)  
[2SK2614\(Te16L1,Q\)](#) [DMN1017UCP3-7](#) [EFC2J004NUZTDG](#) [FCAB21350L1](#) [P85W28HP2F-7071](#) [DMN1053UCP4-7](#) [NTE2384](#) [NTE2969](#)  
[NTE6400A](#) [DMN61D9UWQ-13](#) [US6M2GTR](#) [DMN31D5UDJ-7](#) [SSM6P54TU,LF](#) [DMP22D4UFO-7B](#) [IPS60R3K4CEAKMA1](#)  
[DMN1006UCA6-7](#) [DMN16M9UCA6-7](#) [STF5N65M6](#) [STU5N65M6](#) [C3M0021120D](#) [DMN13M9UCA6-7](#) [BSS340NWH6327XTSA1](#)  
[MCM3400A-TP](#) [DMTH10H4M6SPS-13](#) [IPS60R1K0PFD7SAKMA1](#) [IPS60R360PFD7SAKMA1](#) [IPS60R600PFD7SAKMA1](#)  
[IPS60R210PFD7SAKMA1](#) [DMN2990UFB-7B](#) [ISZ040N03L5ISATMA1](#)