

### Description

The PTVSHC3N18VU transient voltage suppressor is designed to replace multilayer varistors (MLVs) in portable applications such as cell phones, notebook computers, and PDA's. They feature large cross-sectional area junctions for conducting high transient currents, offer desirable electrical characteristics for board level protection, such as fast response time, lower operating voltage, lower clamping voltage and no device degradation when compared to MLVs. The PTVSHC3N18VU protects sensitive semiconductor components from damage or upset due to electrostatic discharge (ESD) and other voltage induced transient events. The PTVSHC3N18VU is available in a DFN2×2-3L package with working voltages of 18 volt.

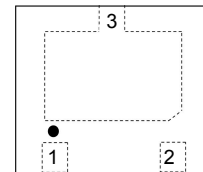

**Pin configuration**

### Feature

- 4000W Peak pulse power per line ( $t_p = 8/20\mu s$ )
- DFN2×2-3L package
- Response time is typically < 1 ns
- Protect one I/O or power line
- Low clamping Voltage
- RoHS compliant
- Transient protection for data lines to  
IEC 61000-4-2(ESD)±30KV(air), ±30KV(contact);  
IEC 61000-4-4 (EFT) 80A (5/50ns),  
IEC 61000-4-5 (Lightning) 138A (8/20us)

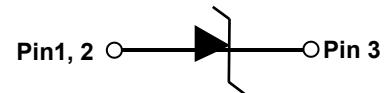

**Circuit Diagram**

### Applications

- Cell phone handsets and accessories
- Personal digital assistants (PDA's)
- Notebooks, desktops, and servers
- Portable instrumentation
- Cordless phones
- Digital cameras
- Peripherals
- MP3 players

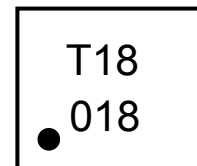

**Marking (Top View)**

### Mechanical Characteristics

- Lead finish:100% matte Sn(Tin)
- Mounting position: Any
- Qualified max reflow temperature:260°C
- Device meets MSL 3 requirements
- Pure tin plating: 7 ~ 17 um

Electronics Parameter

| Symbol    | Parameter                           |
|-----------|-------------------------------------|
| $V_{RWM}$ | Peak Reverse Working Voltage        |
| $I_R$     | Reverse Leakage Current @ $V_{RWM}$ |
| $V_{BR}$  | Breakdown Voltage @ $I_T$           |
| $I_T$     | Test Current                        |
| $I_{PP}$  | Maximum Reverse Peak Pulse Current  |
| $V_C$     | Clamping Voltage @ $I_{PP}$         |
| $P_{PP}$  | Peak Pulse Power                    |
| $C_J$     | Junction Capacitance                |
| $I_F$     | Forward Current                     |
| $V_F$     | Forward Voltage @ $I_F$             |

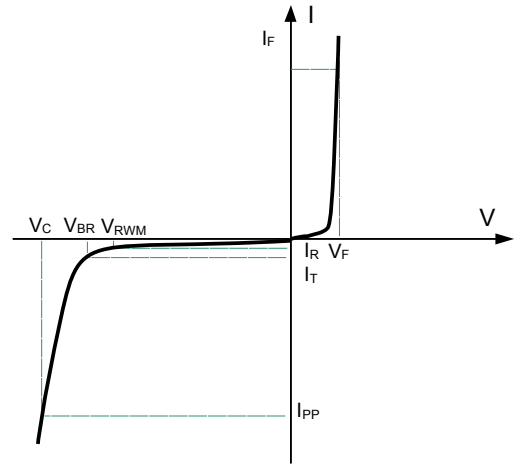

Electrical characteristics per line@25°C ( unless otherwise specified)

| Parameter                    | Symbol    | Conditions                                     | Min. | Typ. | Max. | Units         |
|------------------------------|-----------|--|------|------|------|---------------|
| Peak Reverse Working Voltage | $V_{RWM}$ |  |      |      | 18   | V             |
| Breakdown Voltage            | $V_{BR}$  | $I_t = 1\text{mA}$                             | 19   | 20   | -    | V             |
| Reverse Leakage Current      | $I_R$     | $V_{RWM} = 18\text{V}$                         |      |      | 1    | $\mu\text{A}$ |
| Clamping Voltage             | $V_C$     | $I_{PP} = 30\text{A}$ $t_p = 8/20\mu\text{s}$  |      | 24   | 26   | V             |
| Clamping Voltage             | $V_C$     | $I_{PP} = 138\text{A}$ $t_p = 8/20\mu\text{s}$ |      | 31   | 33   | V             |
| Junction Capacitance         | $C_j$     | $V_R = 0\text{V}$ $f = 1\text{MHz}$            | 700  | 900  | 1100 | pF            |

Notes : Measured from pin 3 to pin 1 and pin 2.

Absolute maximum rating@25°C

| Rating   | Symbol    | Value        | Units              |
|--|-----------|--------------|--------------------|
| Peak Pulse Power ( $t_p = 8/20\mu\text{s}$ )   | $P_{pp}$  | 4000         | W                  |
| Peak Pulse Current ( $t_p = 8/20\mu\text{s}$ ) | $I_{pp}$  | 138          | A                  |
| Lead Soldering Temperature                     | $T_L$     | 260 (10 sec) | $^{\circ}\text{C}$ |
| Operating Temperature                          | $T_J$     | -55 to 150   | $^{\circ}\text{C}$ |
| Storage Temperature                            | $T_{STG}$ | -55 to 150   | $^{\circ}\text{C}$ |

Typical Characteristics

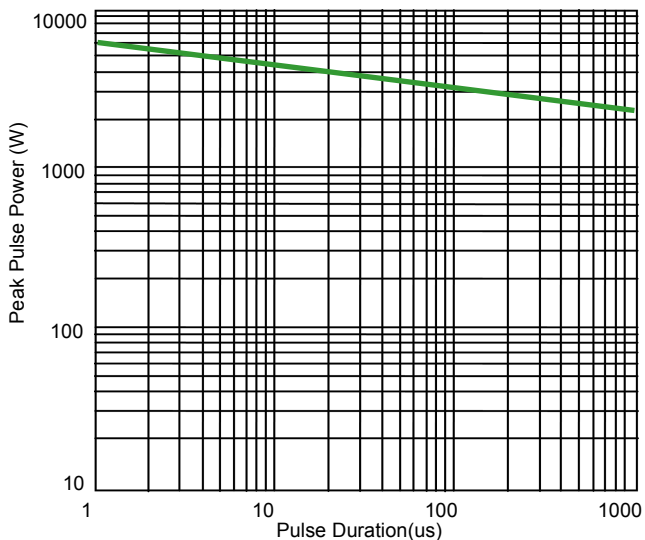
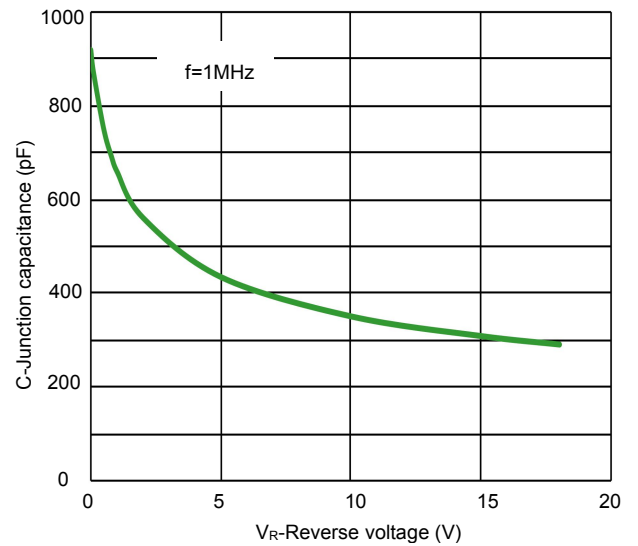
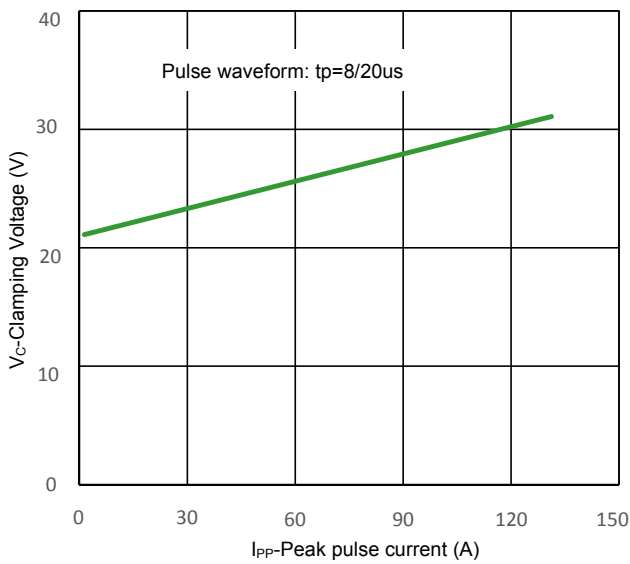
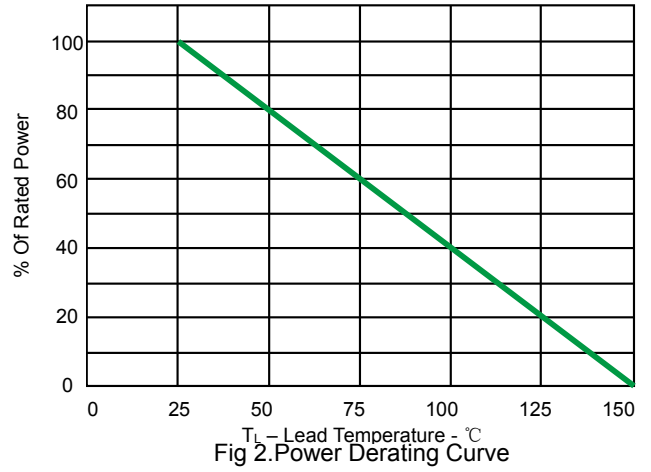
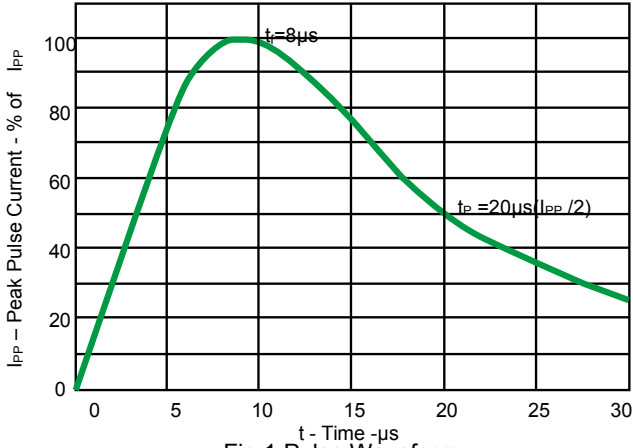

## Solder Reflow Recommendation

Peak Temp=257°C, Ramp Rate=0.802deg. °C/sec

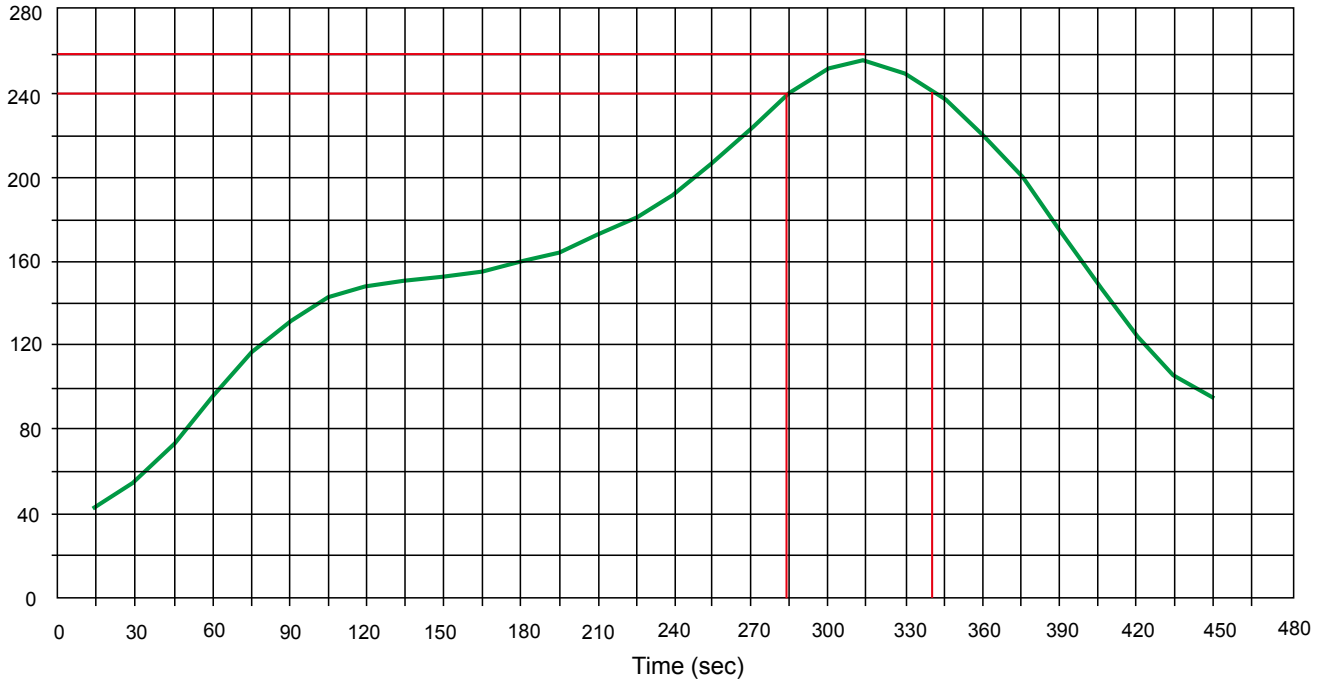

## PCB Design

For TVS diodes a low-ohmic and low-inductive path to chassis earth is absolutely mandatory in order to achieve good ESD protection. Novices in the area of ESD protection should take following suggestions to heart:

- Do not use stubs, but place the cathode of the TVS diode directly on the signal trace.
- Do not make false economies and save copper for the ground connection.
- Place via holes to ground as close as possible to the anode of the TVS diode.
- Use as many via holes as possible for the ground connection.
- Keep the length of via holes in mind! The longer the more inductance they will have.

Product dimension (DFN2×2-3L)

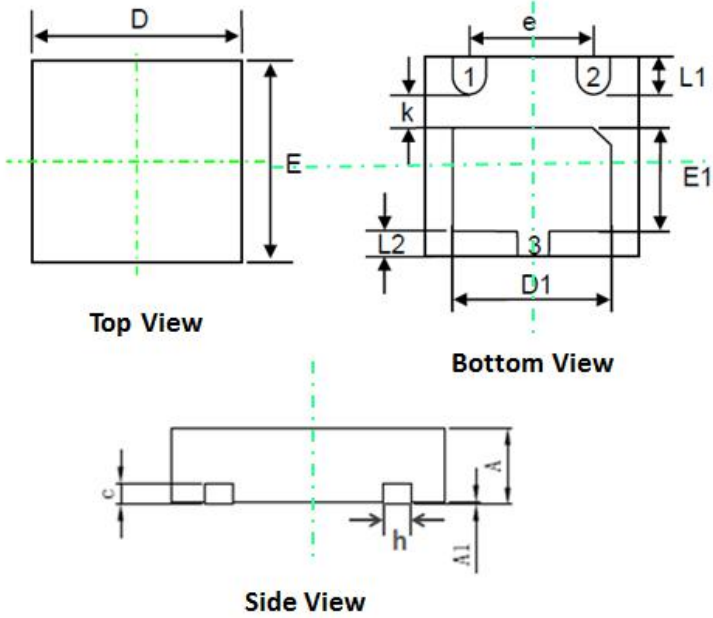

| Dim | Millimeters |      |      |
|-----|-------------|------|------|
|     | MIN         | Typ. | MAX  |
| A   | 0.50        | 0.58 | 0.66 |
| D   | 1.90        | 2.00 | 2.10 |
| D1  | 1.40        | 1.50 | 1.60 |
| E   | 1.90        | 2.00 | 2.10 |
| E1  | 0.95        | 1.05 | 1.15 |
| e   | 1.30BSC     |      |      |
| L1  | 0.35        | 0.40 | 0.45 |
| k   | 0.20        | 0.30 | 0.40 |
| L2  | 0.20        | 0.25 | 0.30 |
| h   | 0.25        | 0.30 | 0.35 |
| c   | 0.15BSC     |      |      |
| A1  | 0.00        | 0.02 | 0.05 |

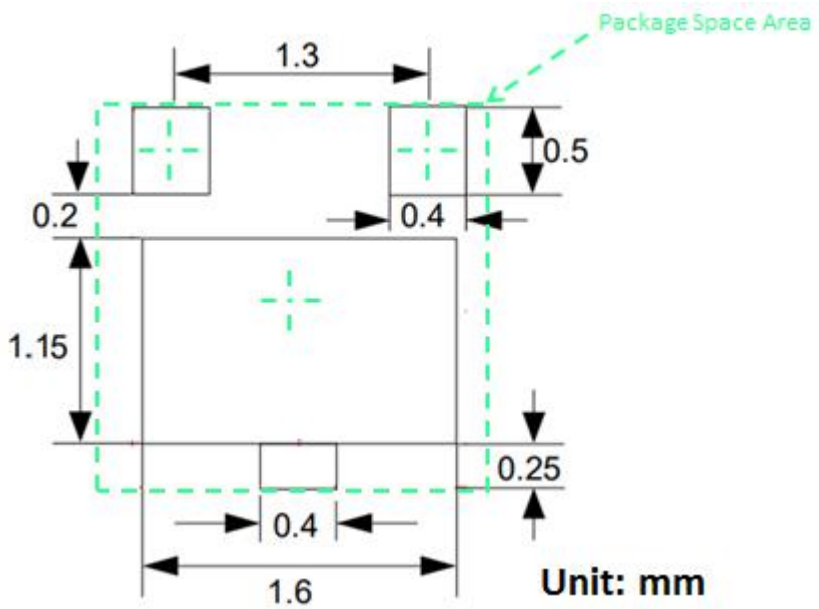

Unit: mm

Ordering information

| Device       | Package             | Reel | Shipping           |
|--------------|---------------------|------|--------------------|
| PTVSHC3N18VU | DFN2×2-3L (Pb-Free) | 7"   | 3000 / Tape & Reel |

Load with information

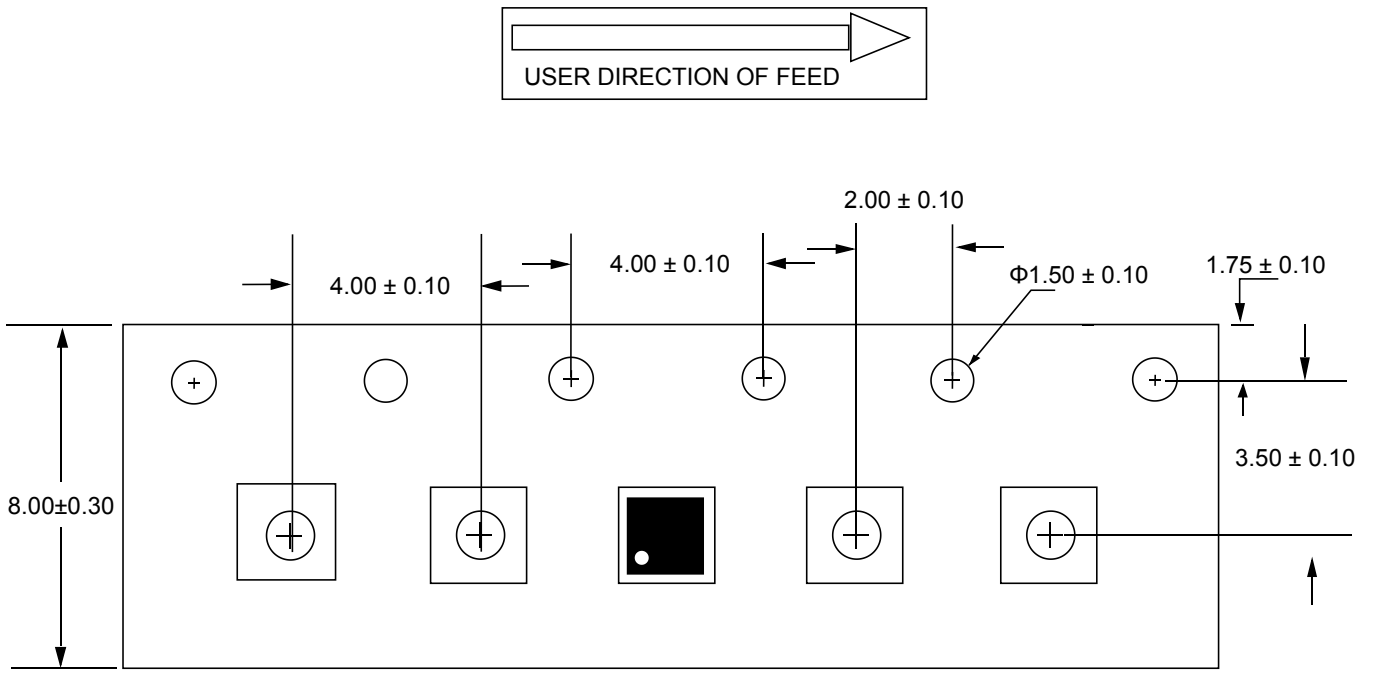

Unit: mm

**IMPORTANT NOTICE**

 and **Prisemi**<sup>®</sup> are registered trademarks of **Prisemi Electronics Co., Ltd (Prisemi)** ,Prisemi reserves the right to make changes without further notice to any products herein. Prisemi makes no warranty, representation or guarantee regarding the suitability of its products for any particular purpose, nor does Prisemi assume any liability arising out of the application or use of any product or circuit, and specifically disclaims any and all liability, including without limitation special, consequential or incidental damages. “Typical” parameters which may be provided in Prisemi data sheets and/or specifications can and do vary in different applications and actual performance may vary over time. All operating parameters, including “Typicals” must be validated for each customer application by customer’s technical experts. Prisemi does not convey any license under its patent rights nor the rights of others. The products listed in this document are designed to be used with ordinary electronic equipment or devices, Should you intend to use these products with equipment or devices which require an extremely high level of reliability and the malfunction of with would directly endanger human life (such as medical instruments, aerospace machinery, nuclear-reactor controllers, fuel controllers and other safety devices), please be sure to consult with our sales representative in advance.

Website: <http://www.prisemi.com>

For additional information, please contact your local Sales Representative.

©Copyright 2009, Prisemi Electronics

 **Prisemi**<sup>®</sup> is a registered trademark of Prisemi Electronics.

All rights are reserved.

## X-ON Electronics

Largest Supplier of Electrical and Electronic Components

*Click to view similar products for [ESD Suppressors / TVS Diodes](#) category:*

*Click to view products by [Prisemi](#) manufacturer:*

Other Similar products are found below :

[NTE4902](#) [P4SMAJ15A](#) [P4SMAJ26A](#) [SMAJ400CA-TP](#) [TGL34-47CA](#) [ESDAULC45-1BF4](#) [SM1605E3/TR13](#) [SMF20A-TP](#) [P4SMAJ12A](#)  
[CPDUR24V-HF](#) [CPDQC5V0USP-HF](#) [CPDQC5V0-HF](#) [MPLAD30KP45CAE3](#) [MMBZ27VCLQ-7-F](#) [MMAD1108/TR13](#) [MPLAD30KP24A](#)  
[ACPDQC5V0R-HF](#) [DFLT170A-7](#) [NTE4900](#) [NTE4926](#) [NTE4938](#) [SMF22A-TP](#) [SMF12A-TP](#) [SLVU2.8-TP](#) [SMLJ6.5CA-TP](#) [SMAJ6.5CA-](#)  
[TP](#) [MMAD1108E3/TR13](#) [D5V0M1U2LP3-7](#) [SMAJ400A-TP](#) [AOZ8811DT-03](#) [AOZ8831DI-05](#) [AOZ8831DT-03](#) [SMAJ188CA](#) [3SMC33CA](#)  
[BK](#) [CPDQC3V3C-HF](#) [CPDQC12VE-HF](#) [MPLAD30KP170CA](#) [82357120100](#) [5.0SMLJ15CA-TP](#) [5KP18A-TP](#) [P6KE8.2A-TP](#)  
[MPLAD30KP43CAE3](#) [SMAJ43A-TP](#) [D5V0F6U8LP33-7](#) [TVS5501V10MUT5G](#) [5.0SMLJ24CA-TP](#) [SMAJ110CA-TP](#) [MPLAD15KP75CAE3](#)  
[MMAD1103e3/TR13](#) [DFLT40AQ-7](#)