

ALKALINE-MANGANESE DIOXIDE BATTERY

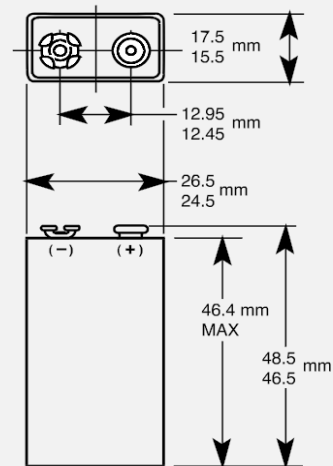

Size: 9V (6LR61) PX1604



Dimensions shown are IEC standards

KEY FEATURES

- Reliable Performance
- Excellent resistance to corrosion
- Designed to meet all major quality, safety and environmental standards:
 - Safety: IEC 60086-5
 - ANSI C 18.1M, Part-2
 - EU Battery Directive
 - Quality: ISO 14001 and 9001, Duracell World Class Continuous Improvement Program

TYPICAL APPLICATIONS

- Carbon Monoxide Detectors
- Smoke Detectors
- Multimeters
- Medical Devices
- Microphones

ELECTRICAL CHARACTERISTICS

- Nominal capacity (2 mA Cont., 5V cut-off) 628 mAh
- Typical Voltage (at + 20 °C) 9 V
- AC Impedance @ 1kHz 1,692 mΩ

PHYSICAL CHARACTERISTICS

- Typical weight 45.3 g (1.6 oz)
- Typical volume 22.8 cm³ (1.4 in³)
- Terminals Miniature snap

OPERATING & STORAGE CONDITIONS

- Operating temperature range -20°C to 54°C (-4°F to 130°F)
- Recommended Storage (storage area should be clean, cool, dry and ventilated) 5°C to 30°C (41°F to 86°F)

TYPICAL PERFORMANCE

Constant Current

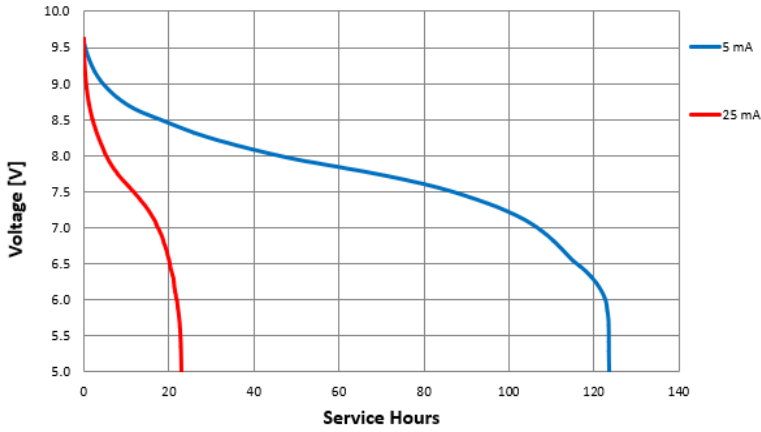

Constant Current

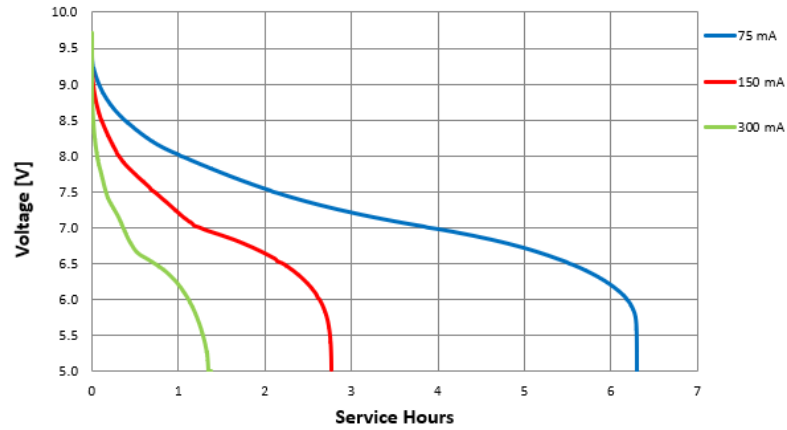

Constant Resistance

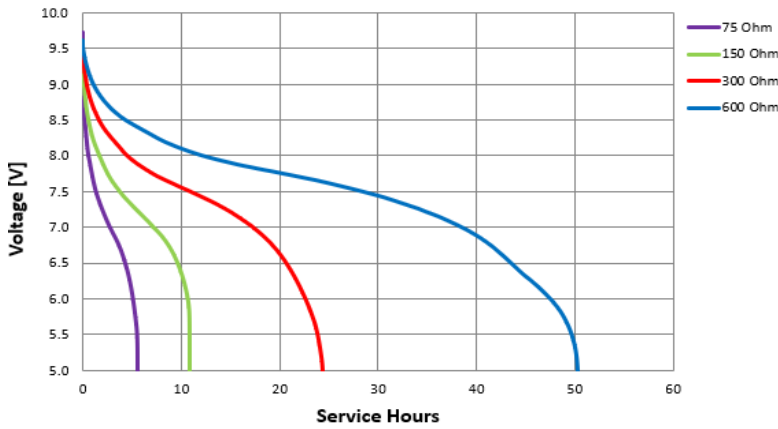

Constant Power

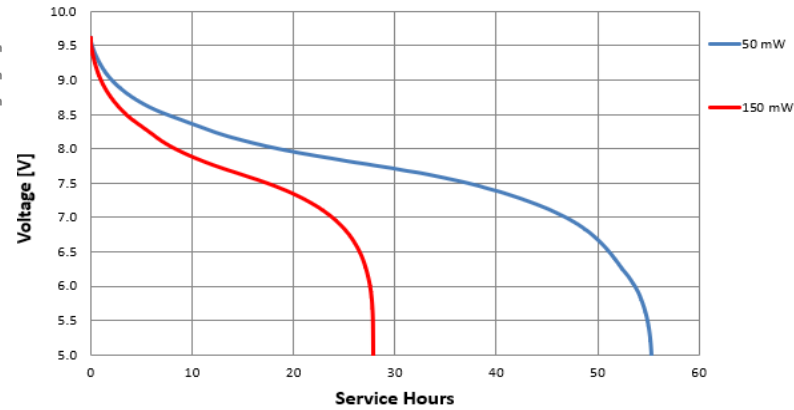

Constant Power

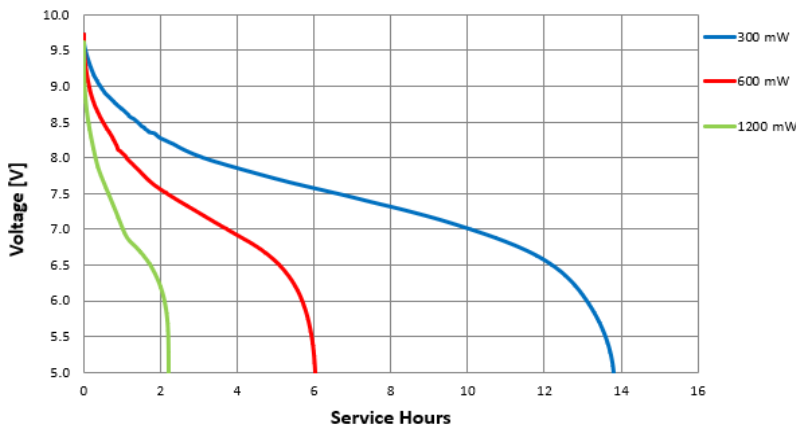

Constant Temperature - 75 mA

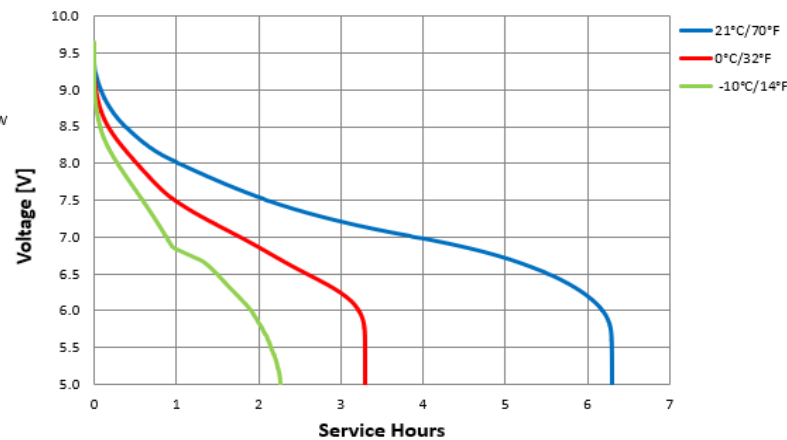

Delivered capacity is dependent on the applied load, operating temperature and cut-off voltage. Please refer to the charts and discharge data shown for examples of the energy/service life that the battery will provide for various load conditions.

This data is subject to change. Performance information is typical. Contact Duracell for the latest information.

X-ON Electronics

Largest Supplier of Electrical and Electronic Components

Click to view similar products for [Cylindrical Battery Contacts, Clips, Holders & Springs](#) category:

Click to view products by [PROCELL](#) manufacturer:

Other Similar products are found below :

[753-00001](#) [12BH36A-GR](#) [200](#) [183](#) [270](#) [QX3506](#) [5220](#) [5230](#) [1055](#) [1088](#) [5250](#) [166](#) [591](#) [1044](#) [KT0008](#) [1119](#) [254TR](#) [5207](#) [1121](#) [246](#)
[4027003022001-PK](#) [12BHC186P2-GR](#) [9V \(6LR61\)](#) [PX1604](#) [GP24E](#) [OKY3399-1](#) [PCM-F04S40 DALY](#) [5000394132023](#) [PCM-F04S30](#)
[DALY](#) [PCM-F08S40 DALY](#) [PCM-F08S60 DALY](#) [PCM-L13S20 DALY](#) [1012](#) [1020](#) [1023](#) [1024](#) [1075](#) [1077](#) [1080](#) [1090](#) [1095](#) [1096](#) [1097](#)
[1098](#) [1109](#) [1126](#) [1127](#) [1128](#) [1162](#) [1173](#) [147](#)