

產品編碼 P/N	PDSQAT-series	測試設備 TEST INSTRUMENT	Keysight:E4991B Chroma:16502 3302
產品系列 Series	扁平线共模电感	測試頻率 TEST FREQUENCY	1KHZ / 0.3V

客戶名稱
Customer :

客戶編碼
Customer P/N :

產品系列
Series : 扁平线共模电感
SQ Common Mode Chokes

產品編碼
Supply P/N : PDSQAT-series

發版號
Version : A2.0

承認日期
Endorsement Date : 2022-9-15

備註
Note :

譜羅德電子科技（深圳）有限公司 PuLuoDe Electronic Technology (Shenzhen) Co. LTD	
製作 APPROVED	Ben
審查 CHECKED	Yuki
確認 PREPARED	Peter

客戶承認

Customer Approval

客戶簽章



產品編碼 P/N	PDSQAT-series	測試設備 TEST INSTRUMENT	Chroma 3302 16502
產品系列 Series	扁平线共模电感	測試頻率 TEST FREQUENCY	100KHZ / 1V

产品特点

Features

- ☐ 寄生电容极低，电磁干扰抑制效果好
Low Parasitic capacitance, EMI suppression effect is best
- ☐ 立式和卧式2种封装，便于PCB结构拓扑
Both vertical and horizontal packages facilitate PCB structure topologies
- ☐ 成本低，可替代磁环共模电感
Low cost, can replace the common mode inductor of magnetic ring
- ☐ 额定电流最高可达10A
Rated current up to 10A MAX



編碼解釋

Code interpretation

PDSQAT	1212	103	M	L	B
類別碼	尺寸系列	感值	精度	立式	带底座
Category code	Dimension	Inductance	Tolerance	Vertical type	Base

- ◎ 規格參數基於環境溫度25℃取得
All test Data is referenced to 25℃ ambient
- ◎ 電感工作環境溫度：-40℃ ~ 105℃
Operating temperature range -40℃ to +105℃
- ◎ 加載額定電流電流會使電感溫度上升大約 40℃ (電感初始溫度+上升溫度=電感最終溫度)
Typical rated current would cause an approximately ΔT of 40℃
- ◎ 務必考慮最終的產品設計，元器件佈局，線路板走線，以及使用環境過程中，電感最終溫度不得超過105℃
The operating temperature of inductance do not exceed 105℃
- ◎ 使用電感時，請查閱第145頁注意事項
The announcements is on page 15



產品編碼 P/N	PDSQAT-series	測試設備 TEST INSTRUMENT	Keysight:E4991B Chroma:16502 3302
產品系列 Series	扁平线共模电感	測試頻率 TEST FREQUENCY	1KHZ / 0.3V

封裝尺寸 (mm)

Dimension

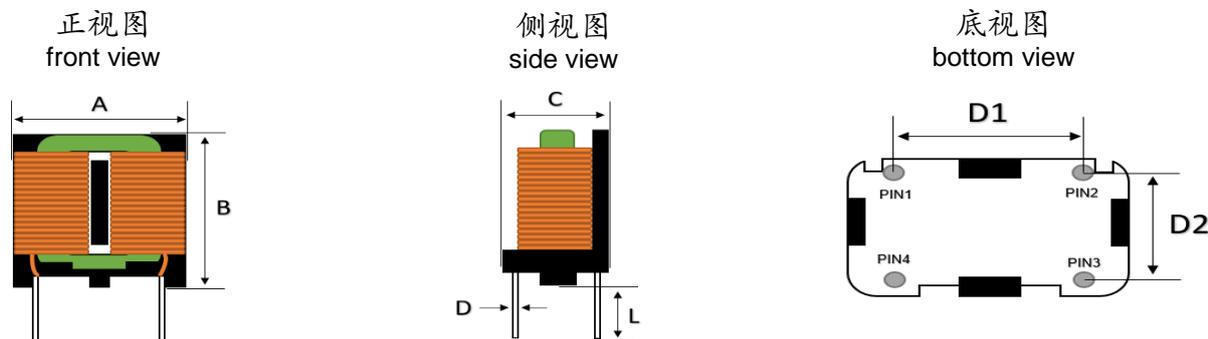

系列	封裝尺寸 Dimension							MPQ
封裝尺寸 Dimension	A	B	C	D	L	D1	D2	154pcs/托盤
	18 Max	18 Max	11 Max	0.6±0.1	3.0 Min	8.0±0.5	6.0±0.5	

編碼解釋

Code interpretation

PDSQAT	1212	103	M	L	B
類別碼	尺寸系列	感值	精度	立式	帶底座
Category code	Dimension	Inductance	Tolerance	Vertical type	Base

電氣參數

Electrical Characteristics

產品編碼 P/N	@ 25 °C Ambient Temperature					
	感值 Inductance	精度 Tolerance	DCR	額定電流 rated current	絕緣電阻 IR	耐壓 HI-POT
	N1/N2	N1/N2	mΩ	A	MΩ	AC 1KV
	mH	mH(Min)	Max	A	Min	AC/60Hz 1mA 3Sec
PDSQAT1212-502MLB	5	4	50	3	100	AC/60Hz 1mA 3Sec
PDSQAT1212-103MLB	10	8	120	2.5	100	
PDSQAT1212-203MLB	20	15	180	2	100	
PDSQAT1212-303MLB	30	24	210	1.8	100	

- ◎ 規格參數基於環境溫度25°C取得
All test Data is referenced to 25°C ambient
- ◎ 電感工作環境溫度：-40°C ~ 105°C
Operating temperature range -40 °C to +105 °C
- ◎ 加載額定電流會使電感溫度上升大約 40°C (電感初始溫度+上升溫度=電感最終溫度)
Typical rated currentt would cause an approximately ΔT of 40°C
- ◎ 務必考慮最終的產品設計，元器件佈局，線路板走線，以及使用環境過程中，電感最終溫度不得超過105°C
The operating temperature of inductance do not exceed 105°C
- ◎ 使用電感時，請查閱第14頁注意事項
The announcements is on page 15



產品編碼 P/N	PDSQAT-series	測試設備 TEST INSTRUMENT	Keysight:E4991B Chroma:16502 3302
產品系列 Series	扁平线共模电感	測試頻率 TEST FREQUENCY	1KHZ / 0.3V

封裝尺寸 (mm)

Dimension

正视图
front view

側视图
side view

底视图
bottom view

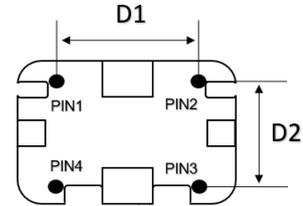
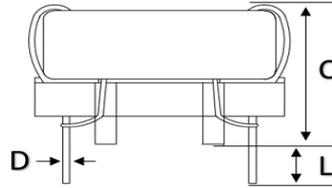
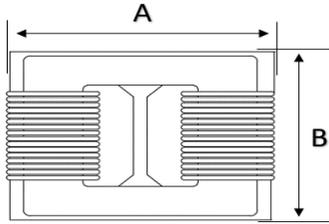

系列	封裝尺寸 Dimension							MPQ
封裝尺寸 Dimension	A	B	C	D	L	D1	D2	198pcs/托盤
	18 Max	15 Max	12 Max	0.7±0.1	3.0 Min	13±0.5	10±0.5	

編碼解釋

Code interpretation

PDSQAT	1212	103	M	W	B
類別碼	尺寸系列	感值	精度	卧式	帶底座
Category code	Dimension	Inductance	Tolerance	Horizontal type	Base

電氣參數

Electrical Characteristics

產品編碼 P/N	@ 25 °C Ambient Temperature					
	感值 Inductance	精度 Tolerance	DCR	額定電流 rated current	絕緣電阻 IR	耐壓 HI-POT
	N1/N2 mH	N1/N2 mH(Min)	mΩ Max	A	MΩ Min	AC 1KV
PDSQAT1212-502MWB	5	4	50	3	100	AC/60Hz 1mA 3Sec
PDSQAT1212-103MWB	10	8	120	2.5	100	
PDSQAT1212-203MWB	20	15	180	2	100	
PDSQAT1212-303MWB	30	24	210	1.8	100	

- ◎ 規格參數基於環境溫度25°C取得
All test Data is referenced to 25°C ambient
- ◎ 電感工作環境溫度：-40°C ~ 105°C
Operating temperature range -40 °C to +105 °C
- ◎ 加載額定電流會使電感溫度上升大約 40°C (電感初始溫度+上升溫度=電感最終溫度)
Typical rated currentt would cause an approximately ΔT of 40°C
- ◎ 務必考慮最終的產品設計，元器件佈局，線路板走線，以及使用環境過程中，電感最終溫度不得超過105°C
The operating temperature of inductance do not exceed 105°C
- ◎ 使用電感時，請查閱第14頁注意事項
The announcements is on page 15



產品編碼 P/N	PDSQAT-series	測試設備 TEST INSTRUMENT	Keysight:E4991B Chroma:16502 3302
產品系列 Series	扁平线共模电感	測試頻率 TEST FREQUENCY	1KHZ / 0.3V

封裝尺寸 (mm)

Dimension

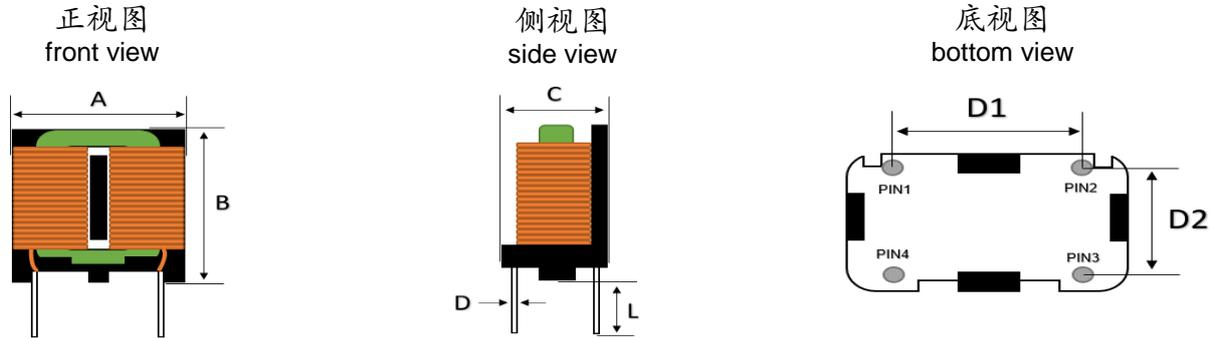

系列	封裝尺寸 Dimension							MPQ
封裝尺寸 Dimension	A	B	C	D	L	D1	D2	90pcs/托盘
	23.5 Max	21.5 Max	15 Max	0.8±0.1	3.0 Min	12.8±0.5	10.0±0.5	

編碼解釋

Code interpretation

PDSQAT	1515	103	M	L	B
類別碼	尺寸系列	感值	精度	立式	帶底座
Category code	Dimension	Inductance	Tolerance	Vertical type	Base

電氣參數

Electrical Characteristics

產品編碼 P/N	@ 25 °C Ambient Temperature					
	感值 Inductance	精度 Tolerance	DCR	額定電流 rated current	絕緣電阻 IR	耐壓 HI-POT
	N1/N2 mH	N1/N2 mH(Min)	mΩ Max	A	MΩ Min	AC 1KV
PDSQAT1515-302MLB	3	2.7	30	6	100	AC/60Hz 1mA 3Sec
PDSQAT1515-502MLB	5	4	50	5	100	
PDSQAT1515-103MLB	10	8	50	4.5	100	
PDSQAT1515-153MLB	15	12	75	3.5	100	
PDSQAT1515-203MLB	20	15	130	3	100	
PDSQAT1515-303MLB	30	24	180	2.5	100	

- ◎ 規格參數基於環境溫度25°C取得
All test Data is referenced to 25°C ambient
- ◎ 電感工作環境溫度：-40°C ~ 105°C
Operating temperature range -40 °C to +105 °C
- ◎ 加載額定電流會使電感溫度上升大約 40°C (電感初始溫度+上升溫度=電感最終溫度)
Typical rated currentt would cause an approximately ΔT of 40°C
- ◎ 務必考慮最終的產品設計，元器件佈局，線路板走線，以及使用環境過程中，電感最終溫度不得超過105°C
The operating temperature of inductance do not exceed 105°C
- ◎ 使用電感時，請查閱第14頁注意事項
The announcements is on page 15



產品編碼 P/N	PDSQAT-series	測試設備 TEST INSTRUMENT	Keysight:E4991B Chroma:16502 3302
產品系列 Series	扁平线共模电感	測試頻率 TEST FREQUENCY	1KHZ / 0.3V

封裝尺寸 (mm)

正视图
front view

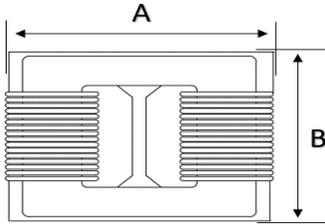

側视图
side view

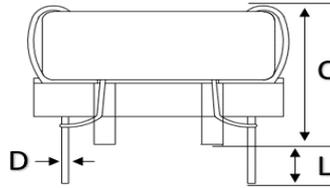

底视图
bottom view

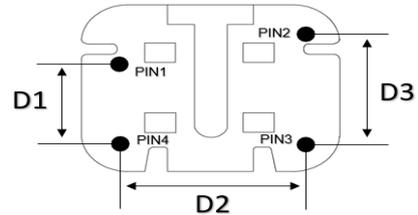

系列	封裝尺寸 Dimension								MPQ
封裝尺寸 Dimension	A	B	C	D	L	D1	D2	D3	120pcs/托盘
	22 Max	17.0 Max	15.5 Max	0.8±0.1	3.0 Min	9.0±0.5	17.0±0.5	12.6±0.5	

編碼解釋

Code interpretation

PDSQAT	1515	103	M	W	B
類別碼	尺寸系列	感值	精度	卧式	带底座
Category code	Dimension	Inductance	Tolerance	Horizontal type	Base

電氣參數

Electrical Characteristics

產品編碼 P/N	@ 25 °C Ambient Temperature					
	感值 Inductance	精度 Tolerance	DCR	額定電流 rated current	絕緣電阻 IR	耐壓 HI-POT
	N1/N2 mH	N1/N2 mH(Min)	mΩ Max	A	MΩ Min	AC 1.5KV
PDSQAT1515-302MWB	3	2.7	30	6	100	AC/60Hz 1mA 3Sec
PDSQAT1515-502MWB	5	4	50	5	100	
PDSQAT1515-103MWB	10	8	50	4.5	100	
PDSQAT1515-153MWB	15	12	75	3.5	100	
PDSQAT1515-203MWB	20	15	130	3	100	
PDSQAT1515-303MWB	30	24	180	2.5	100	

- ◎ 規格參數基於環境溫度25°C取得
All test Data is referenced to 25°C ambient
- ◎ 電感工作環境溫度：-40°C ~ 105°C
Operating temperature range -40 °C to +105 °C
- ◎ 加載額定電流會使電感溫度上升大約 40°C (電感初始溫度+上升溫度=電感最終溫度)
Typical rated current would cause an approximately ΔT of 40°C
- ◎ 務必考慮最終的產品設計，元器件佈局，線路板走線，以及使用環境過程中，電感最終溫度不得超過105°C
The operating temperature of inductance do not exceed 105°C
- ◎ 使用電感時，請查閱第14頁注意事項
The announcements is on page 15



產品編碼 P/N	PDSQAT-series	測試設備 TEST INSTRUMENT	Keysight:E4991B Chroma:16502 3302
產品系列 Series	扁平线共模电感	測試頻率 TEST FREQUENCY	1KHZ / 0.3V

封裝尺寸 (mm)

Dimension

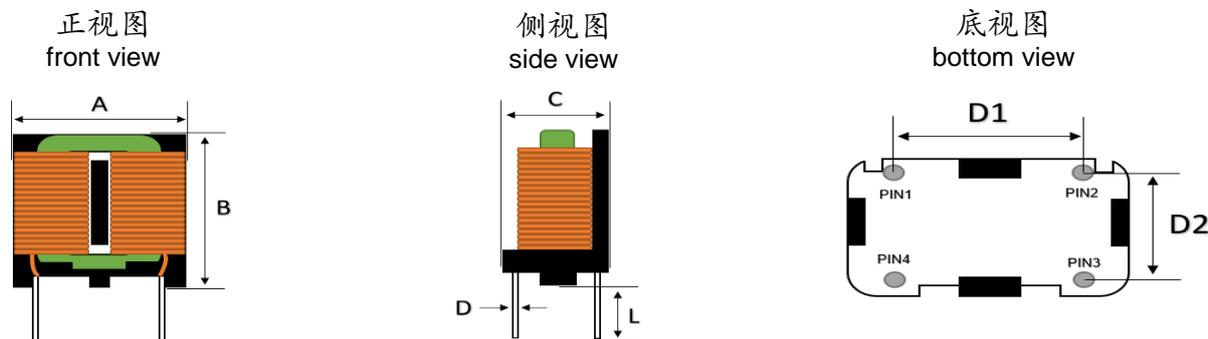

系列	封裝尺寸 Dimension							MPQ
封裝尺寸 Dimension	A	B	C	D	L	D1	D2	90pcs/托盘
	24 Max	25 Max	14.5 Max	0.8±0.1	3.0 Min	12.8±0.5	10.0±0.5	

編碼解釋

Code interpretation

PDSQAT	1918	103	M	L	B
類別碼	尺寸系列	感值	精度	立式	帶底座
Category code	Dimension	Inductance	Tolerance	Vertical type	Base

電氣參數

Electrical Characteristics

產品編碼 P/N	@ 25 °C Ambient Temperature					
	感值 Inductance	精度 Tolerance	DCR	額定電流 rated current	絕緣電阻 IR	耐壓 HI-POT
	N1/N2 mH	N1/N2 mH(Min)	mΩ Max	A	MΩ Min	AC 1KV
PDSQAT1918-103MLB	10	8	50	5	100	AC/60Hz 1mA 3Sec
PDSQAT1918-153MLB	15	12	60	4	100	
PDSQAT1918-203MLB	20	16	75	3.5	100	
PDSQAT1918-303MLB	30	24	95	3	100	

- ◎ 規格參數基於環境溫度25°C取得
All test Data is referenced to 25°C ambient
- ◎ 電感工作環境溫度：-40°C ~ 105°C
Operating temperature range -40 °C to +105 °C
- ◎ 加載額定電流會使電感溫度上升大約 40°C (電感初始溫度+上升溫度=電感最終溫度)
Typical rated currentt would cause an approximately ΔT of 40°C
- ◎ 務必考慮最終的產品設計，元器件佈局，線路板走線，以及使用環境過程中，電感最終溫度不得超過105°C
The operating temperature of inductance do not exceed 105°C
- ◎ 使用電感時，請查閱第14頁注意事項
The announcements is on page 15



產品編碼 P/N	PDSQAT-series	測試設備 TEST INSTRUMENT	Keysight:E4991B Chroma:16502 3302
產品系列 Series	扁平线共模电感	測試頻率 TEST FREQUENCY	1KHZ / 0.3V

封装尺寸 (mm)

正视图
front view

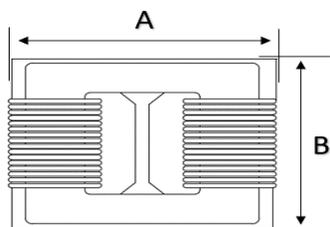

侧视图
side view

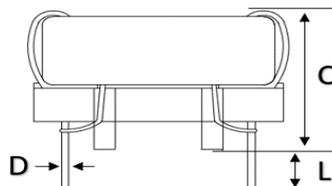

底视图
bottom view

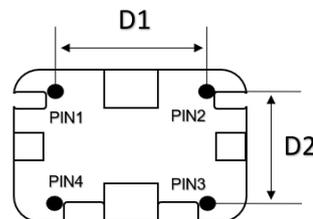

系列	封装尺寸 Dimension							MPQ
封装尺寸 Dimension	A	B	C	D	L	D1	D2	88pcs/托盘
	24 Max	24 Max	16 Max	0.7±0.1	3.0 Min	13±0.5	10±0.5	

編碼解釋

Code interpretation

PDSQAT	1918	103	M	W	B
類別碼	尺寸系列	感值	精度	卧式	带底座
Category code	Dimension	Inductance	Tolerance	Horizontal type	Base

電氣參數

Electrical Characteristics

產品編碼 P/N	@ 25 °C Ambient Temperature					
	感值 Inductance	精度 Tolerance	DCR	額定電流 rated current	絕緣電阻 IR	耐壓 HI-POT
	N1/N2 mH	N1/N2 mH(Min)	mΩ Max	A	MΩ Min	AC 1.5KV
PDSQAT1918-103MWB	10	8	50	5	100	AC/60Hz 1mA 3Sec
PDSQAT1918-153MWB	15	12	60	4	100	
PDSQAT1918-203MWB	20	16	75	3.5	100	
PDSQAT1918-303MWB	30	24	95	3	100	

- ◎ 規格參數基於環境溫度25°C取得
All test Data is referenced to 25°C ambient
- ◎ 電感工作環境溫度：-40°C ~ 105°C
Operating temperature range -40 °C to +105 °C
- ◎ 加載額定電流會使電感溫度上升大約 40°C (電感初始溫度+上升溫度=電感最終溫度)
Typical rated currentt would cause an approximately ΔT of 40°C
- ◎ 務必考慮最終的產品設計，元器件佈局，線路板走線，以及使用環境過程中，電感最終溫度不得超過105°C
The operating temperature of inductance do not exceed 105°C
- ◎ 使用電感時，請查閱第14頁注意事項
The announcements is on page 15



產品編碼 P/N	PDSQAT-series	測試設備 TEST INSTRUMENT	Keysight:E4991B Chroma:16502 3302
產品系列 Series	扁平线共模电感	測試頻率 TEST FREQUENCY	1KHZ / 0.3V

封裝尺寸 (mm)

Dimension

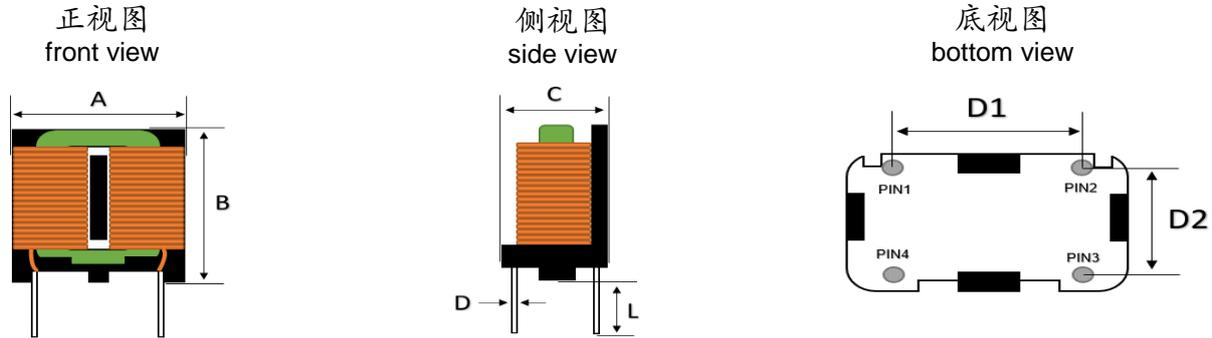

系列	封裝尺寸 Dimension							MPQ
封裝尺寸 Dimension	A	B	C	D	L	D1	D2	72pcs/托盘
	24 Max	31.5 Max	15 Max	0.8±0.1	3.0 Min	12.8±0.5	10.0±0.5	

編碼解釋

Code interpretation

PDSQAT 類別碼 Category code	2418 尺寸系列 Dimension	103 感值 Inductance	M 精度 Tolerance	L 立式 Vertical type	B 帶底座 Base
---------------------------------------	----------------------------------	--------------------------------	-----------------------------	---------------------------------	-------------------------

電氣參數

Electrical Characteristics

產品編碼 P/N	@ 25 °C Ambient Temperature					
	感值 Inductance	精度 Tolerance	DCR	額定電流 rated current	絕緣電阻 IR	耐壓 HI-POT
	N1/N2 mH	N1/N2 mH(Min)	mΩ Max	A	MΩ Min	AC 1KV
PDSQAT2418-202MLB	2	2	16	10	100	AC/60Hz 1mA 3Sec
PDSQAT2418-103MLB	10	8	36	6.5	100	
PDSQAT2418-153MLB	15	12	45	5.5	100	
PDSQAT2418-203MLB	20	16	60	4.5	100	
PDSQAT2418-303MLB	30	24	75	4	100	

- ◎ 規格參數基於環境溫度25°C取得
All test Data is referenced to 25°C ambient
- ◎ 電感工作環境溫度：-40°C ~ 105°C
Operating temperature range -40 °C to +105 °C
- ◎ 加載額定電流會使電感溫度上升大約 40°C (電感初始溫度+上升溫度=電感最終溫度)
Typical rated currentt would cause an approximately ΔT of 40°C
- ◎ 務必考慮最終的產品設計，元器件佈局，線路板走線，以及使用環境過程中，電感最終溫度不得超過105°C
The operating temperature of inductance do not exceed 105°C
- ◎ 使用電感時，請查閱第14頁注意事項
The announcements is on page 15



產品編碼 P/N	PDSQAT-series	測試設備 TEST INSTRUMENT	Keysight:E4991B Chroma:16502 3302
產品系列 Series	扁平线共模电感	測試頻率 TEST FREQUENCY	1KHZ / 0.3V

封裝尺寸 (mm)

Dimension

正视图
front view

側视图
side view

底视图
bottom view

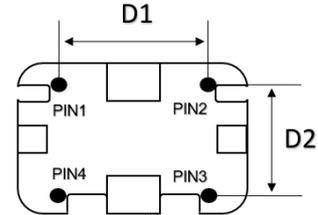
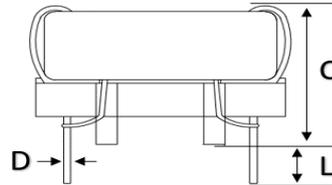
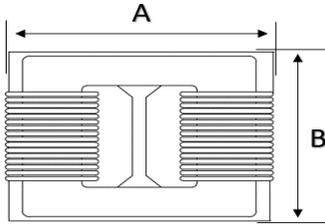

系列	封裝尺寸 Dimension							MPQ
封裝尺寸 Dimension	A	B	C	D	L	D1	D2	86pcs/托盘
	27 Max	24 Max	16 Max	0.8±0.1	3.0 Min	21.0±0.5	17.0±0.5	

編碼解釋

Code interpretation

PDSQAT	2418	103	M	W	B
類別碼	尺寸系列	感值	精度	卧式	带底座
Category code	Dimension	Inductance	Tolerance	Horizontal type	Base

電氣參數

Electrical Characteristics

產品編碼 P/N	@ 25 °C Ambient Temperature					
	感值 Inductance	精度 Tolerance	DCR	額定電流 rated current	絕緣電阻 IR	耐壓 HI-POT
	N1/N2 mH	N1/N2 mH(Min)	mΩ Max	A	MΩ Min	AC 1.5KV
PDSQAT2418-202MWB	2	2	16	10	100	AC/60Hz 1mA 3Sec
PDSQAT2418-103MWB	10	8	36	6.5	100	
PDSQAT2418-153MWB	15	12	45	5.5	100	
PDSQAT2418-203MWB	20	16	60	4.5	100	
PDSQAT2418-303MWB	30	24	75	4	100	

- ◎ 規格參數基於環境溫度25°C取得
All test Data is referenced to 25°C ambient
- ◎ 電感工作環境溫度：-40°C ~ 105°C
Operating temperature range -40 °C to +105 °C
- ◎ 加載額定電流會使電感溫度上升大約 40°C (電感初始溫度+上升溫度=電感最終溫度)
Typical rated currentt would cause an approximately ΔT of 40°C
- ◎ 務必考慮最終的產品設計，元器件佈局，線路板走線，以及使用環境過程中，電感最終溫度不得超過105°C
The operating temperature of inductance do not exceed 105°C
- ◎ 使用電感時，請查閱第14頁注意事項
The announcements is on page 15



產品編碼 P/N	PDSQAT-series	測試設備 TEST INSTRUMENT	Keysight:E4991B Chroma:16502 3302
產品系列 Series	扁平线共模电感	測試頻率 TEST FREQUENCY	1KHZ / 0.3V

电路图 Schematic

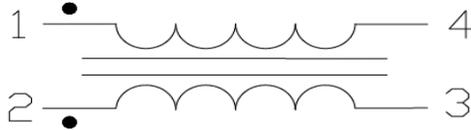

◎ 电感内置两组线圈
Inductor Contents Two (2) Set(s) of Coil

◎ 查看电感铜线线径请联系谱罗德索取单颗规格书
To check the diameter of copper wire, please contact PROD

内部構造 Internal Structure

NO.	材料 ITEM	材質規格 Material	製造商 Manufacturer	UL NO.
1	磁芯/Core	SQ1212/1515/1918/2418	Shandong Wuhuan (或等同廠商規格)	N.A
2	铜线/Wire	UEWH 180°C	SONG TIAN (或等同廠商規格)	E318511
3	底座/Base	T375HF	CHANG CHUN PLASTICS (或等同廠商規格)	E59481
4	凡立水/Varnish	DB-809-1	DABANG MAGNETIC (或等同廠商規格)	E337004
5	锡条/Sn	LEAD FREE SOLDER	CHENG NAN (或等同廠商規格)	N.A

焊接溫度 (推荐)

Recommended Soldering Temperature Graph

TEMPERATURE (°C)

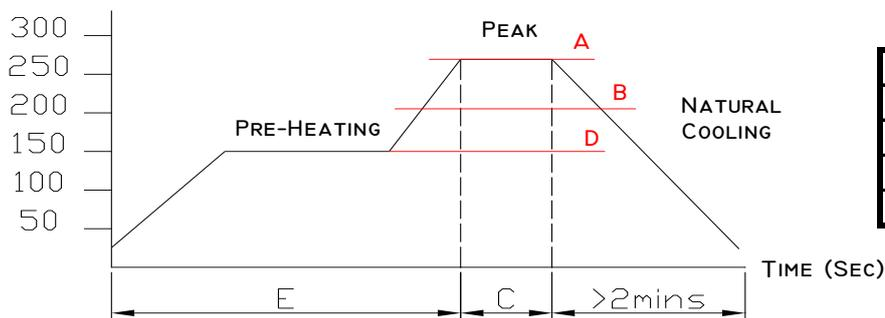

產品編碼 P/N	PDSQAT1212-203MLB	測試設備 TEST INSTRUMENT	Chroma: 3302 16502
產品系列 Series	扁平线共模电感	測試頻率 TEST FREQUENCY	1KHZ / 0.3V

内盒包装

MPQ packaging

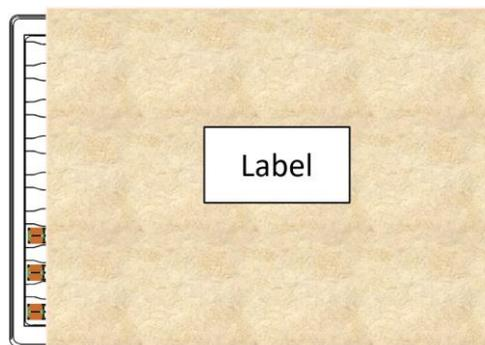
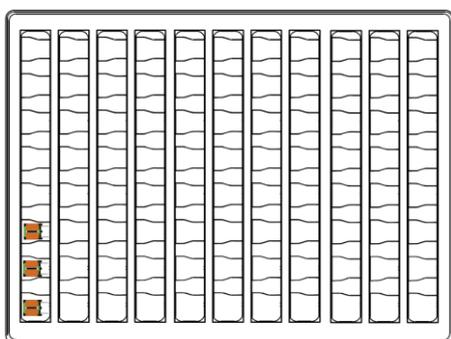

产品使用吸塑盒包装，每托盘顶部放一块纸板
Packging in plastic trays, Place a piece of cardboard on top of every trays

外箱

full container load

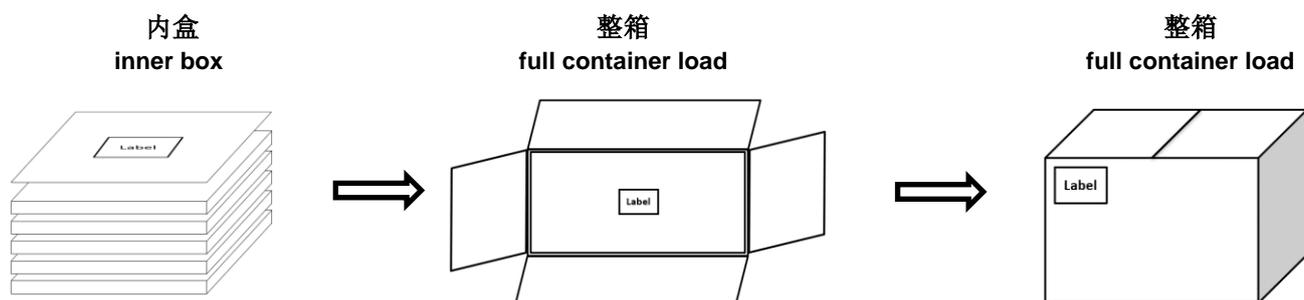

每箱内装10小盒
10 little boxes fill a whole case

尺寸与重量

Size and Weight

	单颗产品 single	内盒 inner box	整箱 full container load
尺寸 Size	N.A	40x29x12 cm	41x30x20 cm
净重 net weight	请向PROD索取单颗规格书查看产品重量		
毛重 gross weight			



注意事項

使用本產品時，請注意以下事項

- ◎ 產品保存期限為12個月，保存條件：溫度5~40℃，濕度10~75%RH以內，超過保存期限可能會使產品端子電極發生氧化。
- ◎ 請勿在極端環境下使用和保存（高鹽，強酸，強鹼，強輻射等）。
- ◎ 產品焊接前，請進行預熱；預熱溫度與焊接溫度之間溫差建議控制在150℃以內。
- ◎ 產品焊接後需重新拆卸焊接修正時，請遵循規格書規定的條件範圍；過高的加熱溫度以及反復的拆卸可能會導致產品失效。
- ◎ 產品請勿接觸清洗劑，酒精等液體，這會侵蝕產品本體，從而導致產品失效。
- ◎ 產品焊接到線路板後，請注意不可因線路板整體變形或局部變形而施加給電感剩餘應力，這可能會導致電感發生破裂，脫落，以致失效。
- ◎ 產品通電後溫度會隨電流的增大而上升，設計時請務必考慮留有餘量。
- ◎ 過高的靜電會對產品產生永久性損害，請注意靜電防護。
- ◎ 產品通電過程請勿觸摸產品任何部位，防止觸電。
- ◎ 本產品作為磁性產品，設計時請務必考慮周邊元器件與本產品可能產生的相互影響。
- ◎ 本產品適用於一般電子設備，如：AV設備，通信設備，家電產品，娛樂設備，電腦設備，個人設備，辦公設備，計測設備，工業機器人等。且該一般電子設備需在常規的操作和使用方法環境下使用。對於需要高度安全性和可靠性的，或者因本產品失效造成設備故障，誤操作，運轉不良等危及到人的生命身體及財產安全，以及對社會產生較大不良影響的特殊用途，設計使用前務必同本公司溝通，設計使用者如在未取得我司書面同意狀況下使用造成任何後果，我司不予承擔。特殊用途包含但不限定如下清單：
 - 1 軍用設備
 - 2 運輸設備（汽車，軌道交通產品，船舶等）
 - 3 航空，航太設備
 - 4 發電控制設備
 - 5 核動力相關設備
 - 6 爆炸引燃控制設備
 - 7 交通控制設備
 - 8 關係到國防安全的設備
 - 9 其他被認定為特殊用途的設備





ANNOUNCEMENTS

Please read this before using the product.

- © The product storage life is 12 months, Storage Temperature: TEMP.5~40°C; RH10%~75%. Please use the product within the warranty period
- © Do not use or store in locations where there are conditions such as gas corrosion (salt, acid, alkali, radiation etc.) .
- © Before soldering, be sure to preheat components:The preheating temperature should be set so that The temperature difference between the solder temperature and chip temperature does not exceed 150° C.
- © Soldering corrections after mounting should be within the range of the conditions determined in the specifications. If overheated, a short circuit, performance deterioration, or lifespan shortening may occur. Repeated disassembly may invalidate the inductance
- © The cleaning agent can not be used for these products. This may corrode the inductor
- © When embedding a printed circuit board where a chip is mounted to a set, be sure that residual stress is not given to the chip due to the overall distortion of the printed circuit board and partial distortion such as at screw tightening portions.
- © Self heating (Rated Current or Irms) occurs when the power is turned ON, so the tolerance should be sufficient for the set thermal design.
- © Too high static electricity will cause permanent damage to the product, please pay attention to electrostatic protection.
- © As a magnetic product, the design must consider the possible interaction between peripheral components and the product.
- © The products listed on this catalog are intended for use in general electronic equipment (AV equipment, telecommunications equipment, home appliances, amusement equipment, computer equipment, personal equipment, office equipment, measurement equipment, industrial robots) under a normal operation and use condition.
The products are not designed or warranted to meet the requirements of the applications listed below, whose performance and/or quality require a more stringent level of safety or reliability, or whose failure, malfunction or trouble could cause serious damage to society, person or property.
If you intend to use the products in the applications listed below or if you have special requirements exceeding the range or conditions set forth in the each catalog, please contact PROD. Otherwise, PROD will not bear the serious consequences caused by product quality problems

- | | |
|--|---|
| 1 Military equipment | 8 Medical equipment |
| 2 Transportation equipment (cars, trains, ships, etc.) | 9 Other applications that are not considered general-purpose applications |
| 3 Aerospace/aviation equipment | |
| 4 Power-generation control equipment | |
| 5 Atomic energy-related equipment | |
| 6 Explosive ignition control equipment | |
| 7 Transportation control equipment | |



X-ON Electronics

Largest Supplier of Electrical and Electronic Components

Click to view similar products for [Common Mode Chokes / Filters](#) category:

Click to view products by [PROD Technology](#) manufacturer:

Other Similar products are found below :

[PE-64683](#) [RD5122-6-9M6](#) [ST6118T-R](#) [FE3X025-10-7NL](#) [T8114NLT](#) [TCM0806G-350-2P-T](#) [TCM0806G-650-2P-T](#) [IND-0110](#)
[UAL21VR0802000](#) [UALSC023000000](#) [UALSC1020JH000](#) [UALSU10VD20010](#) [UALSU9VD070100](#) [36-00037](#) [CM7060M132R-10](#)
[UALW21HS072450](#) [UALSU9H0208000](#) [UAL24VK06450CH](#) [PLT10HH501100PNB](#) [PLT10HH401100PNB](#) [PLT10HH1026R0PNB](#) [36-](#)
[00029-01](#) [PE-67531](#) [TLH10UB](#) [113 OR5](#) [2752045447](#) [CM8663Z161B-10](#) [7351V](#) [CMF16-153131](#) [T8116NLT](#) [CMS2-10-R](#) [FE2X10-4-2NL](#)
[T8003NLT](#) [CTX01-13663](#) [CTX66-19521-R](#) [RC212-0.5-10M](#) [RC112-0.4-15M](#) [RC212-0.6-6M8](#) [RC212-0.4-15M](#) [RC112-0.3-30M](#) [4534-3](#)
[WTCF2012Z0M751PB](#) [PH9408.814NLT](#) [B82498B3221J000](#) [PAC6006.364NLT](#) [PAC6006.444NLT](#) [PAC6006.204NLT](#) [PH9407.204NLT](#)
[PAC6006.264NLT](#) [PH9408.105NLT](#) [PH9408.494NLT](#)