

ProLight PE8A-FFTE-WERGBVD
0.4W 4 in 1 RGBV Power LED
Technical Datasheet
Version: 1.1

ProLight Opto ® PE8A Series

Features

- R, G, B, V four color in one Package
- Good color uniformity
- Lead free reflow soldering
- RoHS compliant
- No UV
- Moisture Sensitivity Level - JEDEC Level 5a

Main Applications

- Indoor and Outdoor display
- Outdoor Lighting for Amusement
- Consumer Electronics

Introduction

- PE8A-FFTE-WERGBVD colorful series is a color changeable LED with maximum 4 color chips in one package. It's creating a small optical source for excellent optical control and efficient color mixing.
- PE8A-FFTE-WERGBVD colorful series is much suitable for the application of color- changing lighting , indoor and outdoor display , and entertainment lighting.

Emitter Mechanical Dimensions

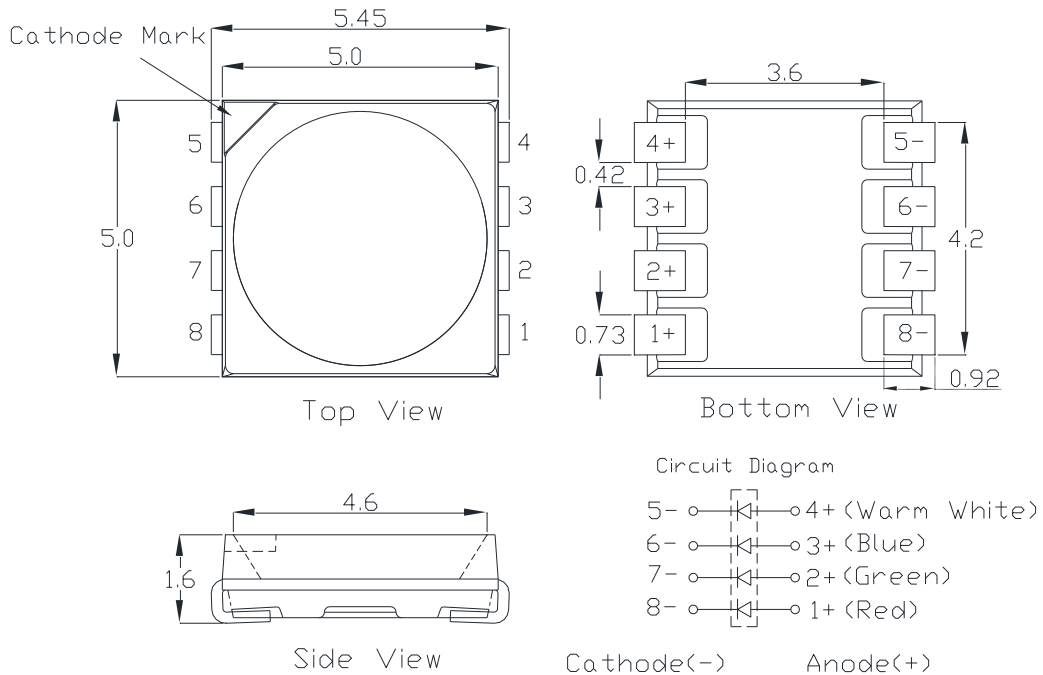

Notes:

1. The cathode side of the device is denoted by the chamfer on the part body.
2. Drawing not to scale.
3. All dimensions are in millimeters.
4. Unless otherwise indicated, tolerances are $\pm 0.10\text{mm}$.
5. Please do not bend the leads of the LED, otherwise it will damage the LED.
6. **Please do not use a force of over 0.3kgf impact or pressure on the lens of the LED, otherwise it will cause a catastrophic failure.**

*The appearance and specifications of the product may be modified for improvement without notice.

Intensity Characteristics, $T_j = 25^\circ\text{C}$

Radiation Pattern	Color	Part Number Emitter	Test Current (mA)	Luminous Intensity (mcd) or Flux Φ_v (lm)		CRI Min.
				Min.	Typ.	
Lambertian	Red	PE8A-FFTE-WERGBVD	20	770 mcd	900 mcd	-
	Green		20	1550 mcd	1850 mcd	-
	Blue		20	330 mcd	400 mcd	-
	Warm White		60	18 lm	20 lm	80

- ProLight maintains a tolerance of $\pm 10\%$ on intensity and flux measurements.

Electrical Characteristics, $T_j = 25^\circ\text{C}$

Color	Test Current (mA)	Forward Voltage V_F (V)		
		Min.	Typ.	Max.
Red	20	1.90	2.20	2.50
Green	20	2.80	3.00	3.40
Blue	20	2.80	3.00	3.40
Warm White	60	2.90	3.15	3.50

- ProLight maintains a tolerance of $\pm 0.1\text{V}$ for Voltage measurements.

Optical Characteristics, $T_j = 25^\circ\text{C}$

Color	Test Current (mA)	Dominant Wavelength λ_D or Color Temperature CCT			Total included Angle (degrees) $\theta_{0.90V}$	Viewing Angle (degrees) $2\theta_{1/2}$
		Min.	Typ.	Max.		
Red	20	619 nm	622 nm	624 nm	160	115
Green	20	521 nm	524 nm	526 nm	160	115
Blue	20	465 nm	468 nm	470 nm	160	115
Warm White	60	2850 K	3050 K	3250 K	160	115

- ProLight maintains a tolerance of $\pm 1\text{nm}$ for dominant wavelength measurements.
- ProLight maintains a tolerance of $\pm 5\%$ for CCT measurements.

Absolute Maximum Ratings

Parameter	Red	Green	Blue	Warm White
DC Forward Current (mA)	20	20	20	60
Peak Pulsed Forward Current (mA)	30	30	30	90
(less than 1/10 duty cycle@1KHz)				
ESD Sensitivity (HBM per MIL-STD-883E Method 3015.7)	> ±500V			
LED Junction Temperature	105°C			
Operating Board Temperature at Maximum DC Forward Current	-40°C - 85°C			
Storage Temperature	-40°C - 85°C			
Allowable Reflow Cycles	2			
Reverse Voltage	Not designed to be driven in reverse bias			

Photometric Luminous Intensity Bin Structure at 20mA

Color	Bin Code	Minimum Luminous Intensity (mcd)	Maximum Luminous Intensity (mcd)
Red	A	770	1000
	B	1000	1300
Green	A	1550	2000
	B	2000	2600
Blue	A	330	430
	B	430	560

- ProLight maintains a tolerance of $\pm 10\%$ on Intensity measurements.

Photometric Luminous Flux Bin Structure at 60mA

Color	Bin Code	Minimum Photometric Flux (lm)	Maximum Photometric Flux (lm)
Warm White	A	18	23
	B	23	29

- ProLight maintains a tolerance of $\pm 10\%$ on flux measurements.

Dominant Wavelength Bin Structure at 20mA

Color	Bin Code	Minimum Dominant Wavelength (nm)	Maximum Dominant Wavelength (nm)
Red	4	619	624
Green	1	521	526
Blue	2	465	470

- ProLight maintains a tolerance of $\pm 1\text{nm}$ for dominant wavelength measurements.

Color Bin at 60mA

Warm White Binning Structure Graphical Representation

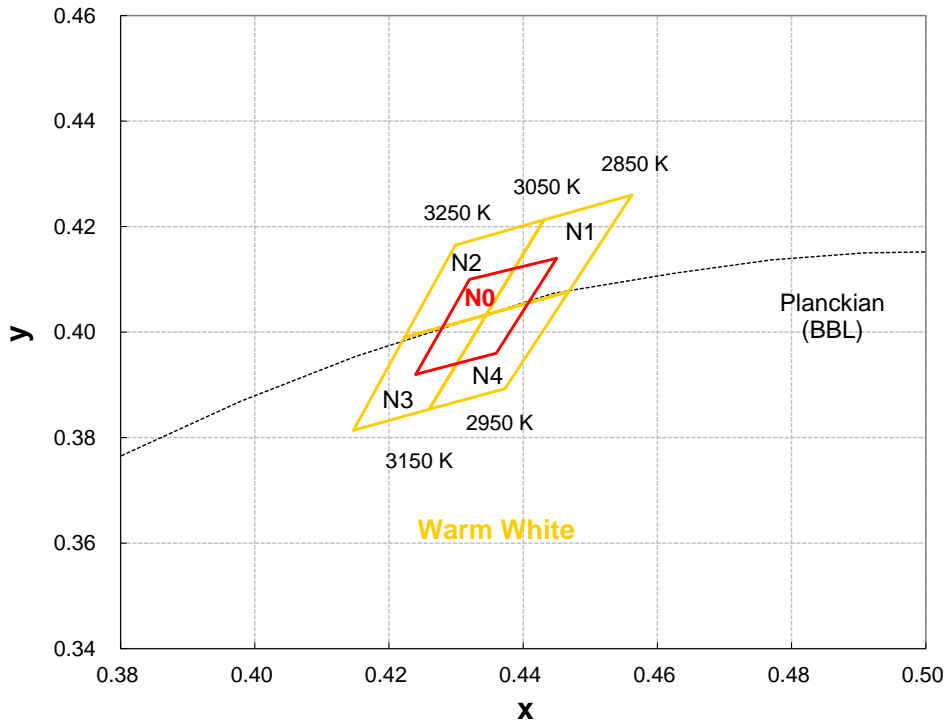

Warm White Bin Structure

Bin Code	x	y	Typ. CCT (K)	Bin Code	x	y	Typ. CCT (K)
N0	0.4240	0.3920	3050	N2	0.4299	0.4165	3150
	0.4320	0.4100			0.4431	0.4213	
	0.4450	0.4140			0.4345	0.4033	
	0.4360	0.3960			0.4223	0.3990	
N1	0.4431	0.4213	2950	N3	0.4223	0.3990	3150
	0.4562	0.4260			0.4345	0.4033	
	0.4468	0.4077			0.4260	0.3854	
	0.4345	0.4033			0.4147	0.3814	
N4	0.4345	0.4033	2950				
	0.4468	0.4077					
	0.4373	0.3893					
	0.4260	0.3854					

- Tolerance on each color bin (x , y) is ± 0.01

Note:

1. Although several bins are outlined, product availability in a particular bin varies by production run and by product performance. Not all bins are available in all colors.
2. ProLight **SmartBin** is working to make the color bin smarter, by selecting that intelligence is infused into major **N0** bin with minor N1-N4 bins and processes that make assembly easy

Color Spectrum, $T_j = 25^\circ\text{C}$

1. Blue 、 Green 、 Red

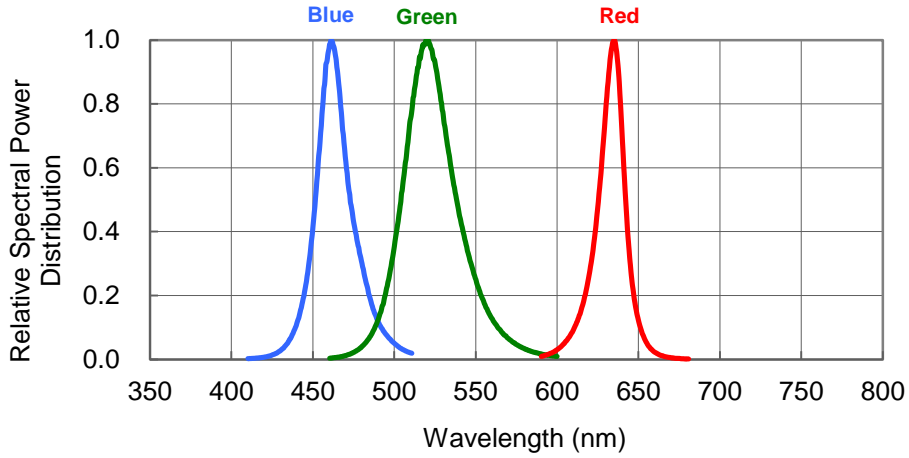

2. Warm White

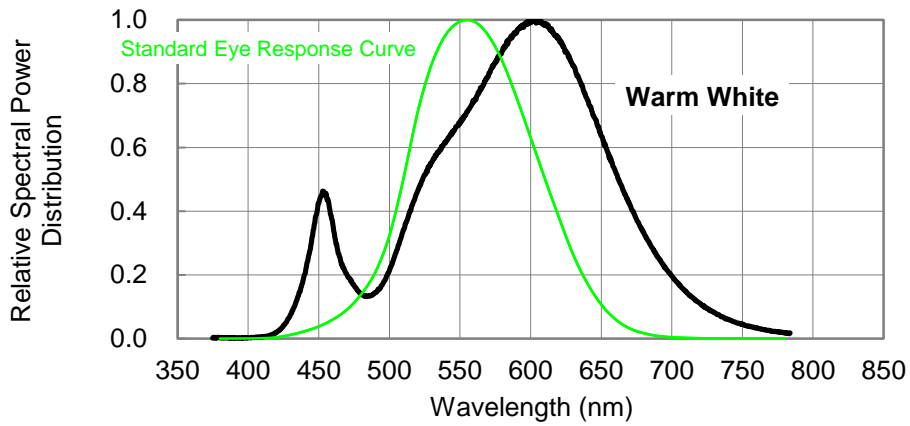

Light Output Characteristics

Relative Light Output vs. Junction Temperature

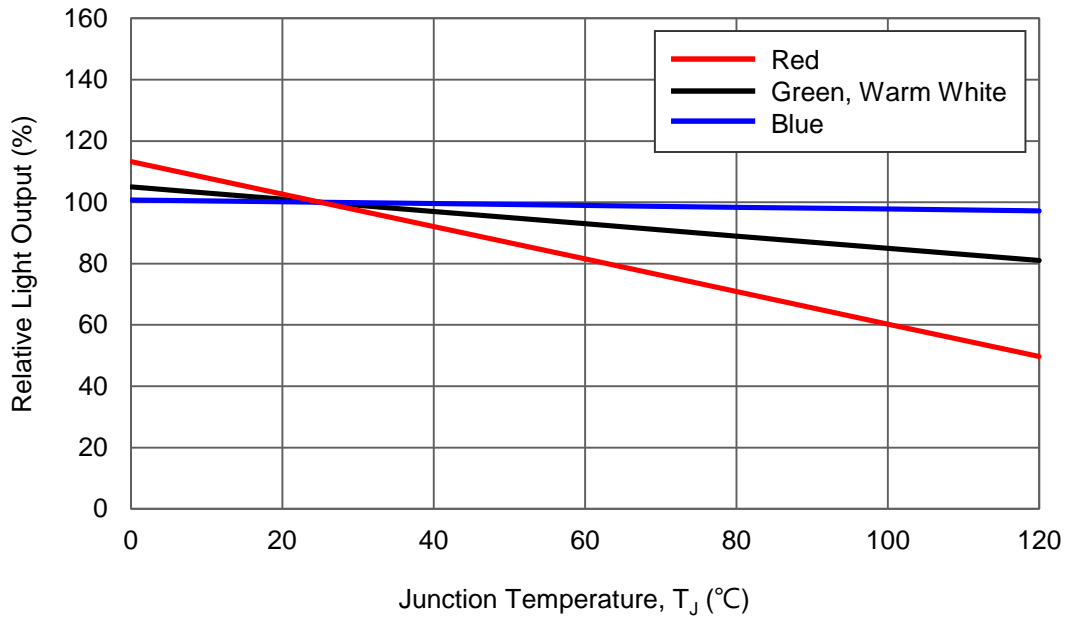

Forward Current Characteristics, $T_j = 25^\circ\text{C}$

1. Forward Voltage vs. Forward Current

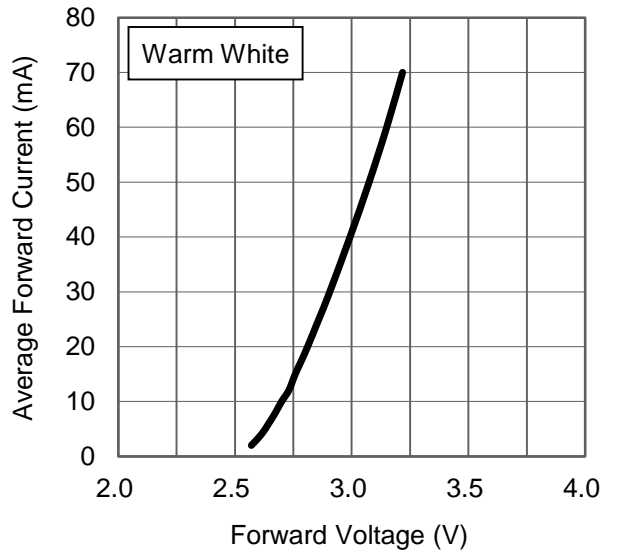
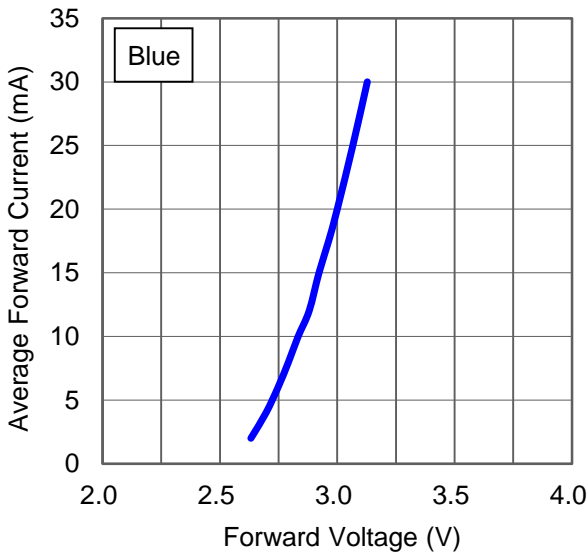
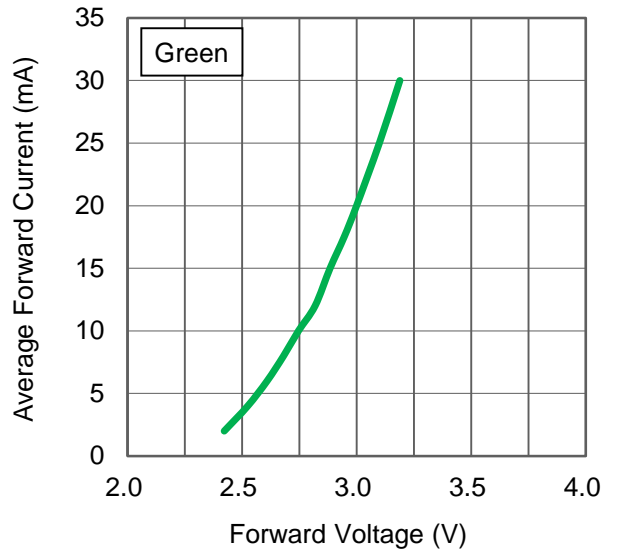
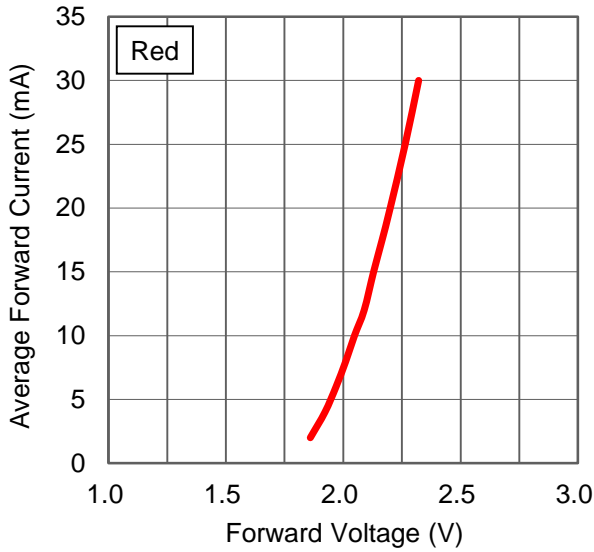

Forward Current Characteristics, $T_j = 25^\circ\text{C}$

2. Forward Current vs. Normalized Relative Luminous Flux

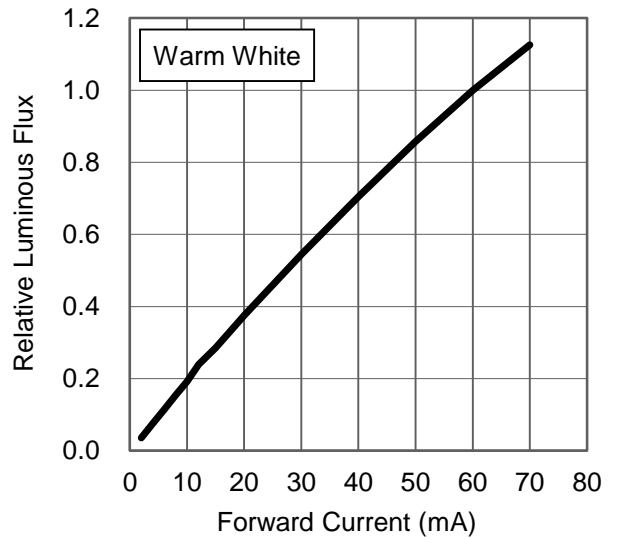
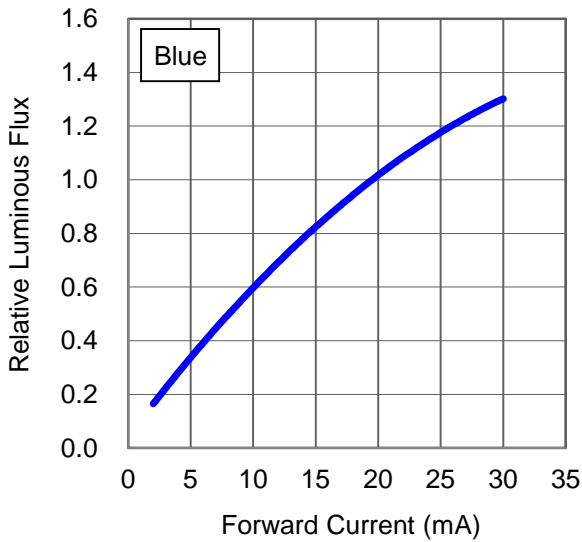
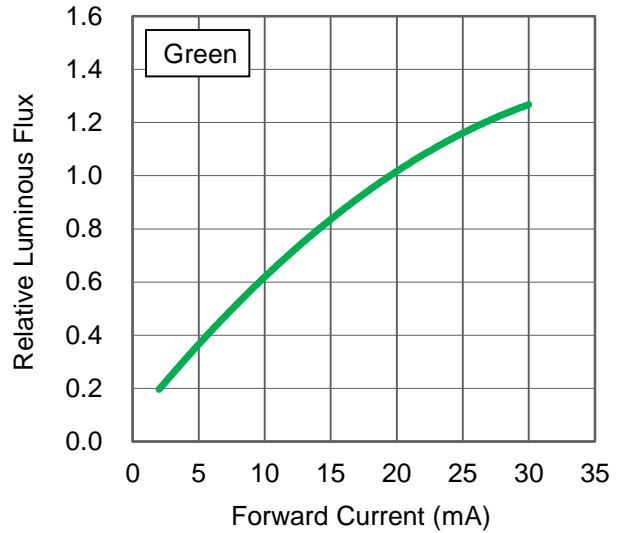
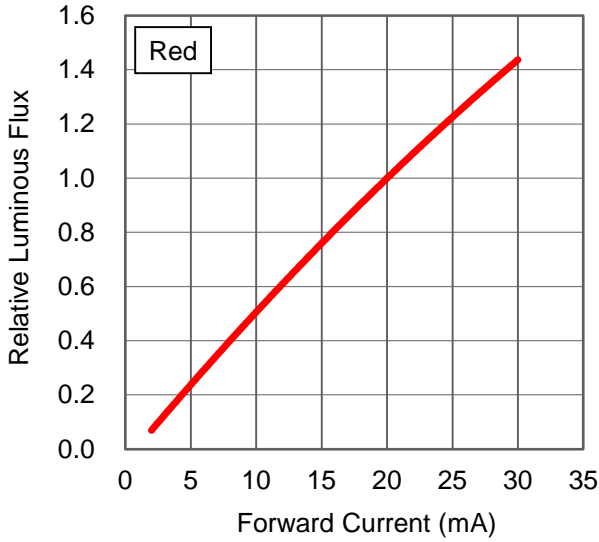

Typical Representative Spatial Radiation Pattern

Lambertian Radiation Pattern

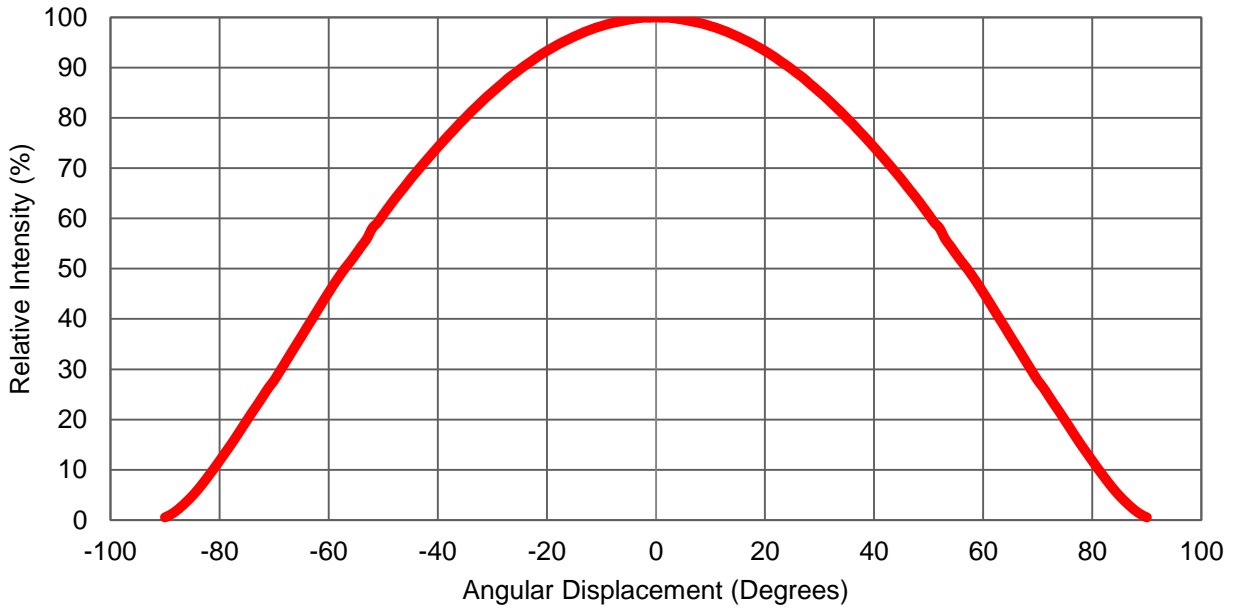

Moisture Sensitivity Level - JEDEC Level 5a

Level	Floor Life		Soak Requirements			
			Standard		Accelerated Environment	
	Time	Conditions	Time (hours)	Conditions	Time (hours)	Conditions
5a	24 hours	≤30°C / 60% RH	48 +2/-0	30°C / 60% RH	10 +0.5/-0	60°C / 60% RH

- The standard soak time includes a default value of 24 hours for semiconductor manufacture's exposure time (MET) between bake and bag and includes the maximum time allowed out of the bag at the distributor's facility.
- Table below presents the moisture sensitivity level definitions per IPC/JEDEC's J-STD-020C.

Level	Floor Life		Soak Requirements			
			Standard		Accelerated Environment	
	Time	Conditions	Time (hours)	Conditions	Time (hours)	Conditions
1	Unlimited	≤30°C / 85% RH	168 +5/-0	85°C / 85% RH	NA	NA
2	1 year	≤30°C / 60% RH	168 +5/-0	85°C / 60% RH	NA	NA
2a	4 weeks	≤30°C / 60% RH	696 +5/-0	30°C / 60% RH	120 +1/-0	60°C / 60% RH
3	168 hours	≤30°C / 60% RH	192 +5/-0	30°C / 60% RH	40 +1/-0	60°C / 60% RH
4	72 hours	≤30°C / 60% RH	96 +2/-0	30°C / 60% RH	20 +0.5/-0	60°C / 60% RH
5	48 hours	≤30°C / 60% RH	72 +2/-0	30°C / 60% RH	15 +0.5/-0	60°C / 60% RH
5a	24 hours	≤30°C / 60% RH	48 +2/-0	30°C / 60% RH	10 +0.5/-0	60°C / 60% RH
6	Time on Label (TOL)	≤30°C / 60% RH	Time on Label (TOL)	30°C / 60% RH	NA	NA

Recommended Solder Pad Design

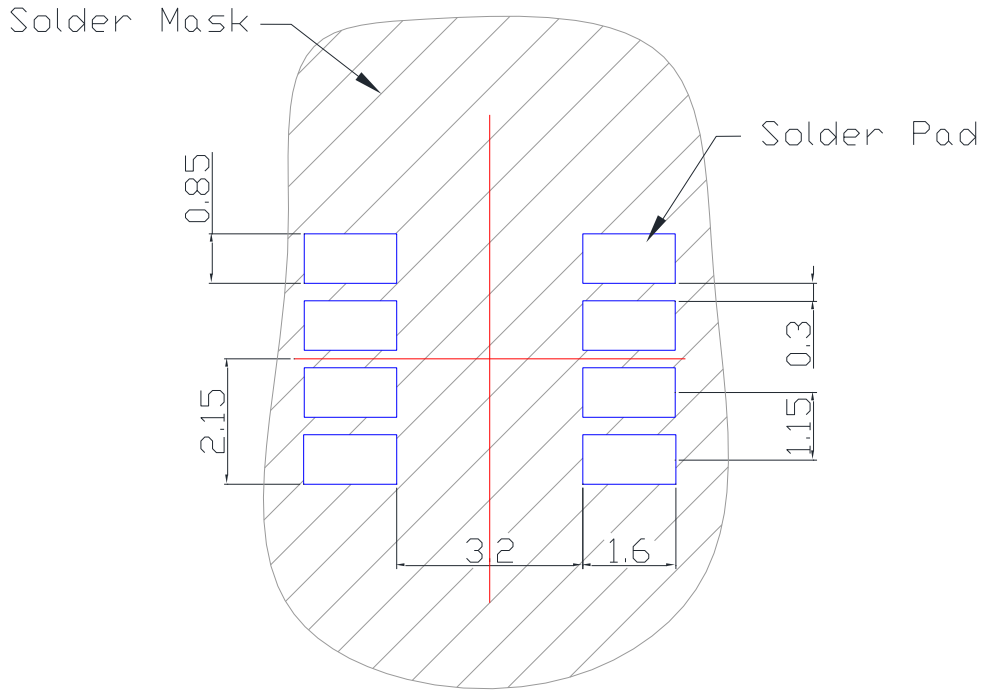

- All dimensions are in millimeters.

Reflow Soldering Condition

Soldering Conditions

Reflow Soldering Profile for lead free soldering

Preconditioning acc. to JEDEC Level 5a

(acc. to J-STD-020D.01)

Profile Feature	Pb-Free Assembly	
	Recommendation	Max. Ratings
Ramp-up Rate to Preheat (25°C to 150°C)	2°C/sec.	3°C/sec. max.
Time t_s from T_{smin} to T_{smax} (150°C to 200°C)	100 sec.	60-120 sec.
Ramp-up Rate to Peak (180°C to T_p)	2°C/sec.	3°C/sec. max.
Liquidus Temperature T_L	217°C	
Time t_L above T_L	80 sec.	100 sec. max.
Peak Temperature T_p	245°C	250°C max.
Time t_p within 5°C of the specified peak temperature ($T_p - 5^\circ\text{C}$)	20 sec.	10-30 sec.
Ramp-down Rate (T_p to 100°C)	3°C/sec.	6°C/sec. max.
Time 25°C to Peak temperature		8 minutes max.

All temperatures refer to the center of the package, measured on the top of the component

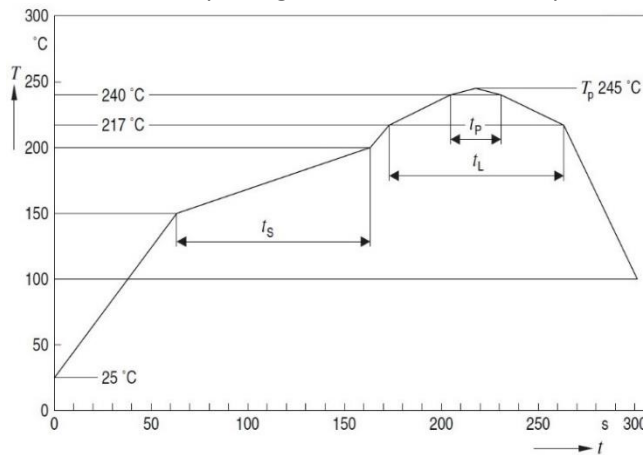

- Do not perform reflow soldering more than twice. Observe necessary precautions of handling moisture-sensitive devices as stated in the following section.
- Do not apply any pressure or force on the LED during reflow and after reflow when the LED is still hot.
- Use reflow soldering to solder the LED. Use hand soldering only for rework if unavoidable, but it must be strictly controlled to following conditions :

(1) Soldering iron tip temperature = 315°C maximum	(3) Number of cycles = 1 only
(2) Soldering duration = 3s maximum	(4) Power of soldering iron = 50W maximum
- Do not touch the LED package body with the soldering iron except for the soldering terminals, because it may cause damage to the LED.
- Confirm beforehand whether the functionality and performance of the LED is affected by soldering with hand soldering.

Emitter Reel Packaging

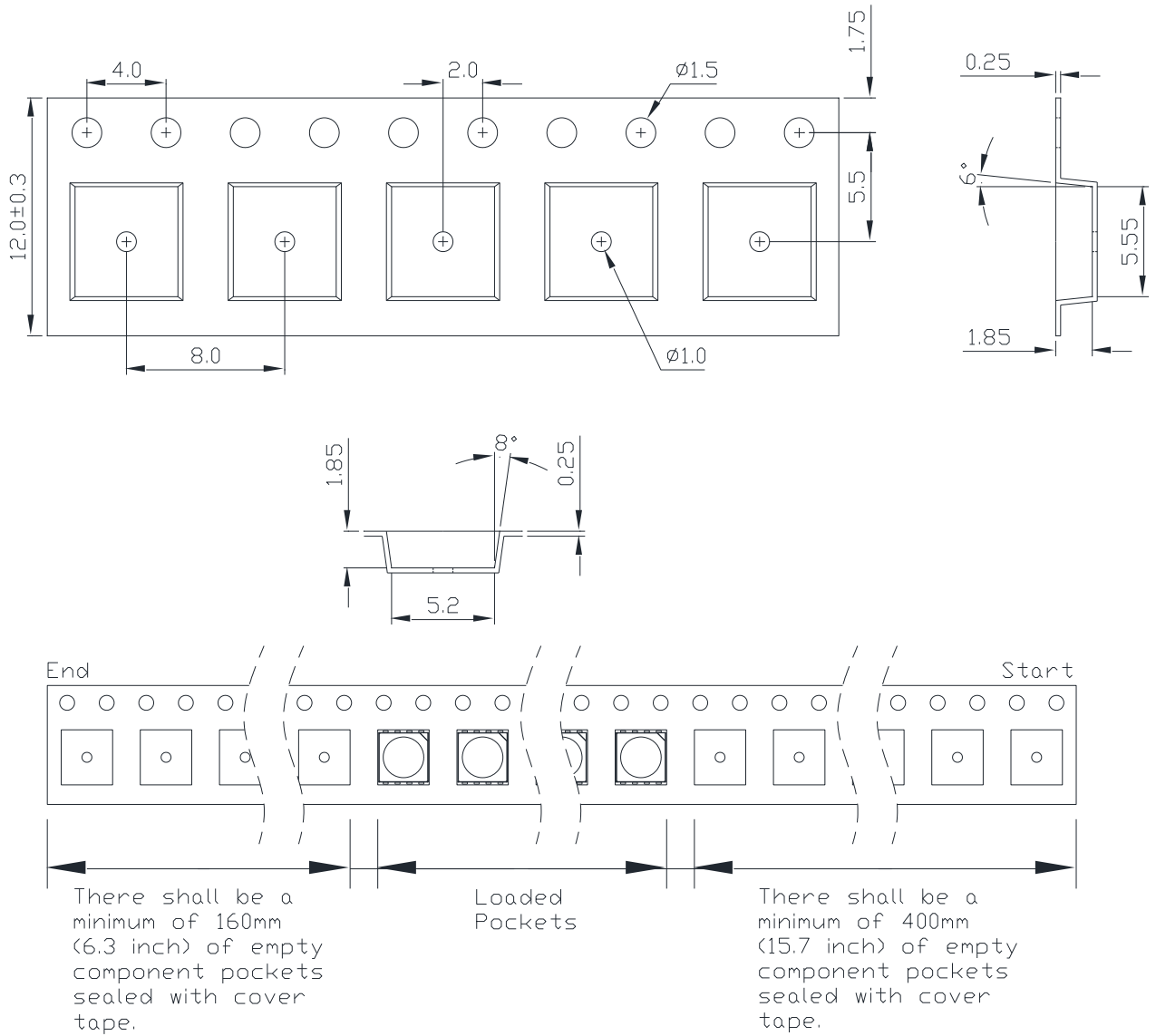

Notes:

1. Drawing not to scale.
2. All dimensions are in millimeters.
3. Unless otherwise indicated, tolerances are ± 0.10 mm.

Emitter Reel Packaging

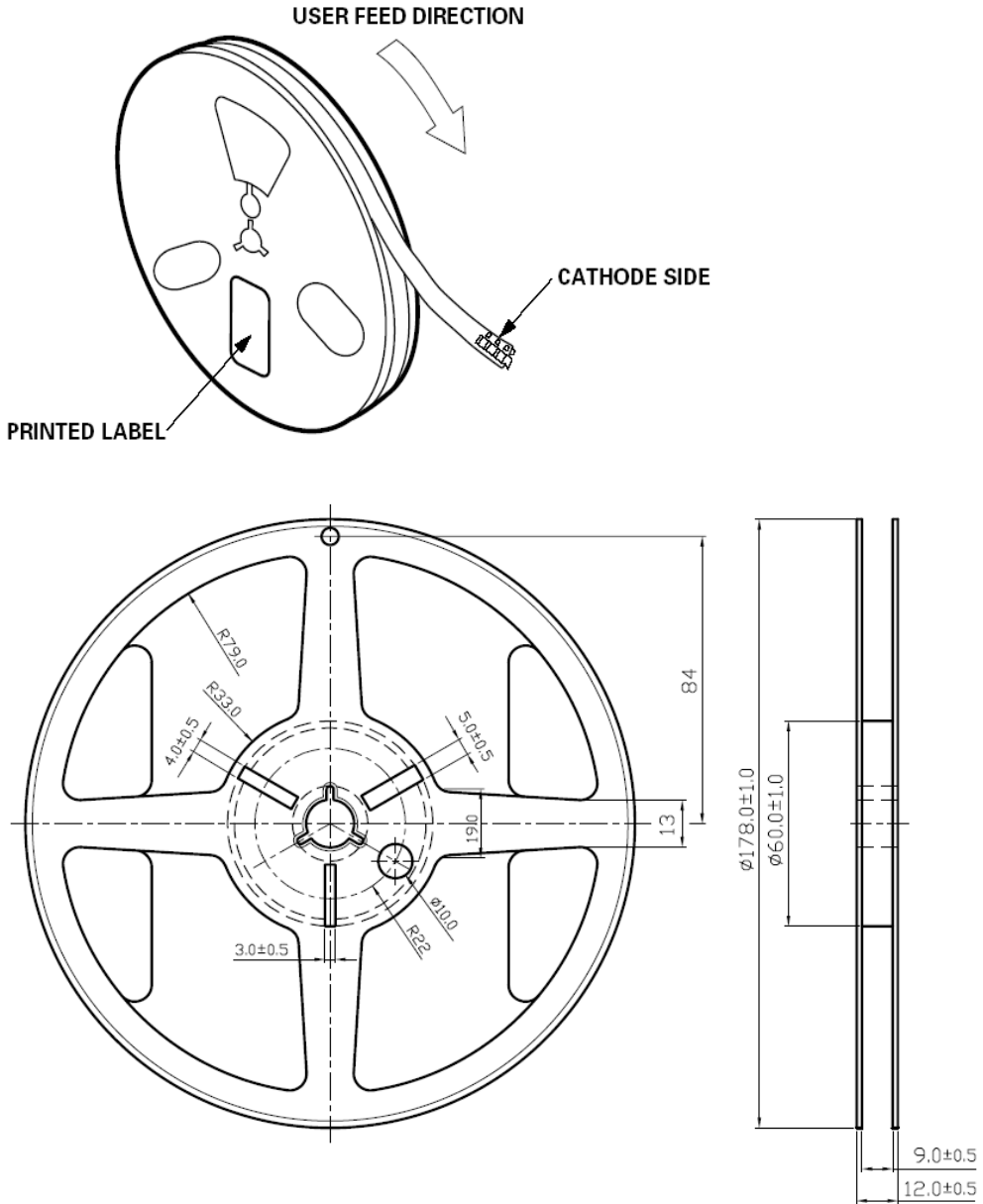

Notes:

1. Empty component pockets sealed with top cover tape.
2. 1000 pieces per reel.
3. Drawing not to scale.
4. All dimensions are in millimeters.

Handling of Moisture-Sensitive Devices

- Before use :
 - (1) An unopened moisture barrier bag (MBB) can be stored at $<40^{\circ}\text{C}/90\% \text{RH}$ for 12 months. If the actual shelf life has exceeded 12 months and the humidity indicator card (HIC) indicates that baking is not required, it is safe to reflow the LEDs per the original MSL rating.
 - (2) Do not open the MBB prior to assembly (for example, for IQC). If unavoidable, the MBB must be properly resealed with fresh desiccant and HIC. The exposed duration must be taken in as floor life.
- Control after opening the MBB :
 - (1) Read the HIC immediately upon opening of MBB.
 - (2) Keep the LEDs at $< 30^{\circ}\text{C}/60\% \text{RH}$ at all times, and complete all high temperature-related processes, including soldering, curing, or rework within 24 hours.
- Control for unfinished reel :

Store unused LEDs in a sealed MBB with desiccant or a desiccator at $<5\% \text{RH}$.
- Control of assembled boards :

If the PCB soldered with the LEDs is to be subjected to other high-temperature processes, store the PCB in a sealed MBB with desiccant or desiccator at $<5\% \text{RH}$ to ensure that all LEDs have not exceeded their floor life of 24 hours.
- Baking is required if :
 - (1) The HIC indicator indicates a change in color for 10% and 5%, as stated on the HIC.
 - (2) The LEDs are exposed to conditions of $> 30^{\circ}\text{C}/60\% \text{RH}$ at any time.
 - (3) The LED's floor life exceeded 24 hours.

The recommended baking condition is: $65^{\circ}\text{C} \pm 5^{\circ}\text{C}$ for 24 hours.
Baking can only be done once.
- Storage :

The soldering terminals of these LEDs are silver plated. If the LEDs are exposed in ambient environments for too long, the silver plating might be oxidized, thus affecting its solderability performance. As such, keep unused LEDs in a sealed MBB with desiccant or in a desiccator at $< 5\% \text{RH}$.

Handling of Silicone Lens LEDs

Notes for handling of silicone lens LEDs

- Please do not use a force of over 0.3kgf impact or pressure on the silicone lens, otherwise it will cause a catastrophic failure.
- The LEDs should only be picked up by making contact with the sides of the LED body.
- Avoid touching the silicone lens especially by sharp tools such as Tweezers.
- Avoid leaving fingerprints on the silicone lens.
- Please store the LEDs away from dusty areas or seal the product against dust.
- When populating boards in SMT production, there are basically no restrictions regarding the form of the pick and place nozzle, except that mechanical pressure on the silicone lens must be prevented.
- Please do not mold over the silicone lens with another resin. (epoxy, urethane, etc)

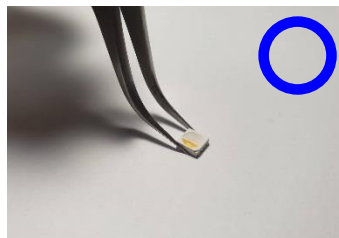
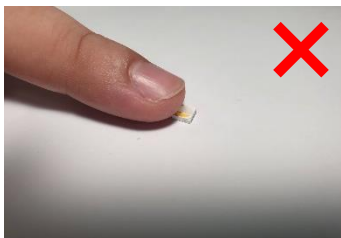

X-ON Electronics

Largest Supplier of Electrical and Electronic Components

Click to view similar products for [Prolight manufacturer](#):

Other Similar products are found below :

[PACC-18FWL-BC8P](#) [PACD-40FNL-BCGP](#) [PACD-40FVL-DCGP](#) [PACE-28FNL-BC4P](#) [PACE-28FVL-BC4P](#) [PACE-28FWL-BC4P](#) [PACF-57FWL-BC8P](#) [PACG-110FVL-BCGP](#) [PACJ-28FNL-EC4N](#) [PACJ-28FVL-DC4N](#) [PACJ-28FWL-BC4N](#) [PACJ-28FWL-DC4N](#) [PACK-35FNL-EC5N](#) [PACK-35FWL-BC5N](#) [PACK-57FNL-BC8N](#) [PACK-57FNL-EC8N](#) [PACK-57FVL-BC8N](#) [PACK-57FVL-EC8N](#) [PACK-57FWL-BC8N](#) [PACL-115FVL-BCGN](#) [PACL-115FVL-ECGN](#) [PASB-16FNL-EC2NS40](#) [PASB-16FVL-EC2NS27](#) [PASB-16FVL-EC2NS30](#) [PASQ-17FVL-D2030](#) [PB2D-1CLA-TC](#) [PB2D-1JLA-TC](#) [PB2D-3JLA-G](#) [PB2D-3JLA-GM](#) [PB2D-UCLA-TC](#) [PBED-15F4E-A](#) [PBLA-3CLA-TC](#) [PBLB-1CQA-TCL](#) [PBLB-3LTE](#) [PBLB-3LTE-RGBN](#) [PBSD-10JLA-G](#) [PBSD-10JLA-GM](#) [PBSD-10JLA-GS](#) [PBSD-10KLA-G](#) [PBSD-10KLA-GS](#) [PBSD-12JLA-KC](#) [PBVF-31FWU-F9G](#) [PC8N-5L4E-C](#) [PC8N-5LTS-C](#) [PDSJ-15FQL-D2748](#) [PDSJ-25FQL-D2748](#) [PDSJ-35FQL-D1840M](#) [PDSJ-35FQL-D2748](#) [PDSJ-40FQL-D2030](#) [PDSQ-10FVL-D1930](#)