

**1 COMBINATION SPANNERS**

• КОМБИНИРОВАННЫЕ ГАЕЧНЫЕ РОЖКОВО-НАКИДНЫЕ КЛЮЧИ • MAULRINGSCHLÜSSEL

PROLINE HD®

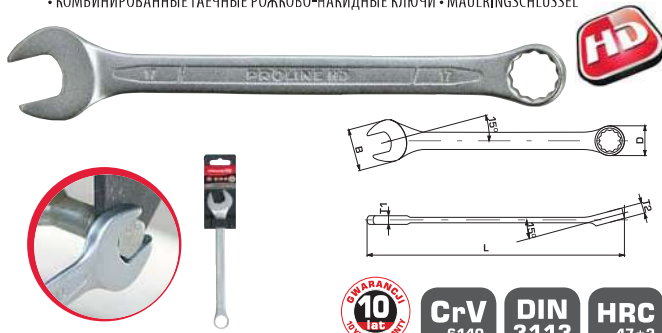

CrV 6140

DIN 3113

HRC 47±2

- Forged • Chromium-plated • Satin • Meet the dimension-related requirements of German DIN 3113 standard • The maximum torque is 60% higher than in German DIN 899 and in US ANSI standard

Code	Size (mm)	L (mm)	B (mm)	D (mm)	T1 (mm)	T2 (mm)	BOX	CUB
35606	6	109	14.5	10.2	3.5	5.3	x	15/90
35607	7	110	16.3	11.2	3.6	5.3	x	15/90
35608	8	120	18.7	12.7	4.0	5.8	x	15/90
35609	9	130	20.8	14.0	4.1	6.6	x	15/90
35610	10	140	22.7	15.1	4.6	7.0	x	15/90
35611	11	159	24.7	16.7	5.0	7.5	x	15/90
35612	12	160	27.2	17.9	5.1	8.1	x	15/90
35613	13	170	28.8	19.7	5.8	8.7	x	15/90
35614	14	180	31.4	20.6	6.0	9.0	x	15/90
35615	15	199	33.3	22.2	6.4	9.3	x	15/90
35616	16	200	35.1	23.7	6.6	10.0	x	15/60
35617	17	210	37.6	24.9	6.8	11.0	x	15/60
35618	18	220	39.6	26.5	7.6	11.5	x	15/60
35619	19	230	41.4	27.9	7.8	12.2	x	15/60
35620	20	240	44.2	29.7	8.1	12.5	x	15/60
35621	21	250	46.2	30.7	8.4	12.8	x	10/40
35622	22	260	48.3	32.1	8.8	13.2	x	10/40
35623	23	270	49.9	33.5	9.0	13.5	x	10/40
35624	24	280	51.5	34.2	9.4	13.5	x	10/40
35625	25	290	54.7	36.7	9.6	14.3	x	10/40
35626	26	300	56.4	37.2	9.8	15.0	x	10/40
35627	27	310	58.8	39.5	10.2	16.5	x	10/40
35628	28	320	59.5	40.6	10.6	17.0	x	10/40
35629	29	339	61.0	41.6	10.8	17.5	x	5/20
35630	30	340	63.1	43.2	11.1	18.5	x	5/20
35632	32	360	67.4	44.7	11.6	19.5	x	5/20
35634	34	470	69.8	48.7	12.6	19.5	x	2/8
35636	36	510	73.8	52.7	13.6	20.5	x	2/8
35638	38	439	73.8	52.7	13.6	20.5	x	2/8
35641	41	550	83.8	60.7	15.6	21.5	x	3/6
35646	46	549	93.5	69.5	17.2	22.5	x	3/6
35650	50	549	98.8	73.7	17.5	22.5	x	3/6

**2 COMBINATION SPANNER SETS**

• НАБОРЫ КОМБИНИРОВАННЫХ ГАЕЧНЫХ РОЖКОВЫХ КЛЮЧЕЙ • MAULRINGSCHLÜSSELSÄTZE

PROLINE HD®



CrV 6140

DIN 3113

HRC 47±2

- Forged • Chromium-plated • Satin • Meet the dimension-related requirements of German DIN 3113 standard • The maximum torque is 60% higher than in German DIN 899 and in US ANSI standard
- **12 pcs.:** 6, 8, 9, 10, 12, 13, 14, 15, 17, 18, 19, 22 mm • **24 pcs.:** 6, 7, 8, 9, 10, 11, 12, 13, 14, 15, 16, 17, 18, 19, 20, 21, 22, 23, 24, 26, 27, 28, 30, 32 mm

Code	Quantity (pcs)	Range (mm)	BOX	CUB
35662	12	6 - 22	x	10
35664	24	6 - 32	x	8

**3 DOUBLE OPEN END SPANNERS**

• КЛЮЧИ ГАЕЧНЫЕ РОЖКОВЫЕ • MAULSCHLÜSSEL

PROLINE HD®



CrV 6140

DIN 3110

HRC 47±2

- Forged • Chromium-plated • Satin • Meet the dimension-related requirements of German DIN 3110 standard • The maximum torque is 60% higher than in German DIN 899 and in US ANSI standard

Code	Size (mm)	L (mm)	B1 (mm)	B2 (mm)	T (mm)	BOX	CUB
34006	6 x 7	123	14.2	17.4	3.4	x	10/60
34008	8 x 9	140	18.1	21.3	3.7	x	10/60
34009	8 x 10	145	18.1	21.3	4.2	x	10/60
34010	10 x 11	156	22.1	25.6	4.7	x	10/60
34012	12 x 13	172	27.6	30.1	5.2	x	10/60
34013	10 x 13	174	26.5	30.1	5.2	x	10/60
34014	14 x 15	190	31.6	33.6	5.7	x	10/60
34016	16 x 17	204	36.1	38.1	6.2	x	10/40
34019	17 x 19	223	40.1	42.1	6.7	x	10/40
34018	18 x 19	221	40.1	42.1	6.8	x	10/40
34022	19 x 22	236	44.1	48.1	7.5	x	10/40
34020	20 x 22	237	44.1	48.1	7.5	x	10/40
34021	21 x 23	246	44.1	50.1	7.7	x	10/40
34024	24 x 27	263	53.1	57.6	8.4	x	10/40
34025	25 x 28	267	53.1	57.6	8.4	x	10/40
34027	27 x 32	294	62.1	68.1	9.4	x	10/40
34030	30 x 32	294	64.1	68.1	9.4	x	10/40

**4 DOUBLE OPEN END SPANNER SETS**

• НАБОРЫ ГАЕЧНЫХ РОЖКОВЫХ КЛЮЧЕЙ • MAULSCHLÜSSELSÄTZE

PROLINE HD®



- Forged • Chromium-plated
- Satin • Meet the dimension-related requirements of German DIN 3110 standard • The maximum torque is 60% higher than in German DIN 899 and in US ANSI standard • **6 pcs.:** 6x7, 8x9, 10x11, 12x13, 14x15, 16x17 mm
- **8 pcs.:** 6x7, 8x9, 10x11, 12x13, 14x15, 16x17, 18x19, 20x22 mm



CrV 6140

DIN 3110

HRC 47±2

Code	Quantity (pcs)	Range (mm)	BOX	CUB
34036	6	6x7 - 16x17	x	30
34038	8	6x7 - 20x22	x	20

PROLINE  
LAHTI PRO  
MEGA  
JUCO  
OTHER BRANDS  
ENDI  
KILINGSPOR  
EXPRESS  
ACTION CAN  
TRYTON  
VALICAN

PROLINE

LANITI PRO

MEGA

JUCO

OTHER BRANDS

ERDI

KLINGSPOR

EXPRESS

ACTION CAN

TRAYTON

VULCAN

### 1 DOUBLE OPEN END SPANNERS FOR MICROMECHANICAL WORKS

• РОЖКОВЫЕ ГАЕЧНЫЕ КЛЮЧИ ДЛЯ МИКРОМЕХАНИКИ  
• DOPPELMAULSCHLÜSSEL FÜR MIKROMECHANISCHE ARBEITEN

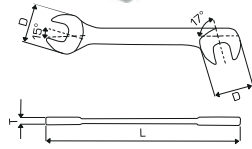

**10** YEAR WARRANTY  
**CrV** 6140 **HRC** 46±2

• Forged • Chromium-plated • Satin • Heads of the same size tilted 75° and 15° and a short, thin handle enable to work in places difficult to reach

Code	Size (mm)	L (mm)	D (mm)	T (mm)		
34054	4	70	10.0	2.4	x	20/200
34055	5	75	13.0	2.4	x	20/200
34056	6	80	15.0	2.7	x	20/200
34057	7	80	15.0	2.7	x	20/200
34058	8	90	18.5	3.0	x	20/200
34059	9	90	18.5	3.0	x	20/200
34060	10	100	22.0	3.0	x	20/200
34061	11	100	22.0	3.0	x	20/200
34062	12	120	27.0	3.5	x	20/200
34063	13	120	27.0	3.5	x	20/200
34064	14	120	27.0	3.5	x	20/100
34065	15	139.4	32.5	4.8	x	20/100
34066	16	139.4	32.5	4.8	x	10/100
34067	17	139.4	32.5	4.8	x	10/100

### 2 STRAIGHT RING SPANNERS

• КЛЮЧИ НАКИДНЫЕ ПРЯМЫЕ • GERADE RINGSCHLÜSSEL

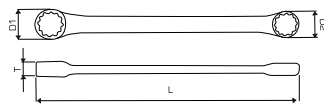

**10** YEAR WARRANTY  
**CrV** 6140 **DIN** 837 **HRC** 46±2

• Forged • Chromium-plated • Satin

Code	Size (mm)	L (mm)	C (mm)	B (mm)	C' (mm)		
36606	6 x 7	120	12.0	10.8	5.5	x	20/200
36608	8 x 9	135	16.5	13.2	6.5	x	20/200
36610	10 x 11	150	19.8	16.5	7.5	x	20/200
36612	12 x 13	165	22.0	19.8	8.5	x	20/100
36614	14 x 15	185	25.0	22.0	8.5	x	20/100
36616	16 x 17	210	26.5	25.0	9.5	x	20/100
36618	18 x 19	225	28.6	27.6	10.5	x	10/50
36620	20 x 22	240	33.6	30.5	12.5	x	5/50
36621	21 x 23	255	35.2	32.0	12.5	x	5/50
36624	24 x 26	270	39.2	36.5	12.5	x	5/40
36625	25 x 28	285	41.4	37.8	13.5	x	5/40
36630	30 x 32	335	48.0	45	14.5	x	5/20

### 3 RING SPANNERS

• КЛЮЧИ ГАЕЧНЫЕ НАКИДНЫЕ ИЗОГНУТЫЕ  
• GERADE RINGSCHLÜSSEL

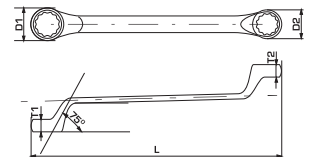

**10** YEAR WARRANTY  
**CrV** 6140 **DIN** 838 **HRC** 47±2

• Forged • Chromium-plated • Satin • Meet the dimension-related requirements of German DIN 3110 standard • The maximum torque is 60% higher than in German DIN 899 and in US ANSI standard

Code	Size (mm)	L (mm)	D1 (mm)	D2 (mm)	T1 (mm)	T2 (mm)		
36006	6 x 7	167	12.0	10.5	6.0	5.3	x	5/30
36008	8 x 9	182	15.0	13.5	7.0	6.3	x	5/30
36010	10 x 11	198	18.0	16.5	8.5	7.3	x	5/30
36012	12 x 13	217	21.0	19.5	9.0	8.7	x	5/20
36014	14 x 15	239	23.5	22.0	9.5	9.0	x	5/20
36016	16 x 17	204	26.5	25.5	11.0	10.5	x	5/20
36018	18 x 19	290	29.5	27.3	12.0	11.0	x	5/20
36020	20 x 22	316	34.5	31.5	13.0	12.0	x	5/20
36021	21 x 23	316	35.0	32.0	13.0	12.0	x	5/20
36024	24 x 27	345	41.2	37.2	14.1	12.5	x	2/8
36025	25 x 28	345	43.0	39.5	14.5	13.5	x	2/8
36030	30 x 32	360	48.5	45.3	16.5	15.0	x	2/8

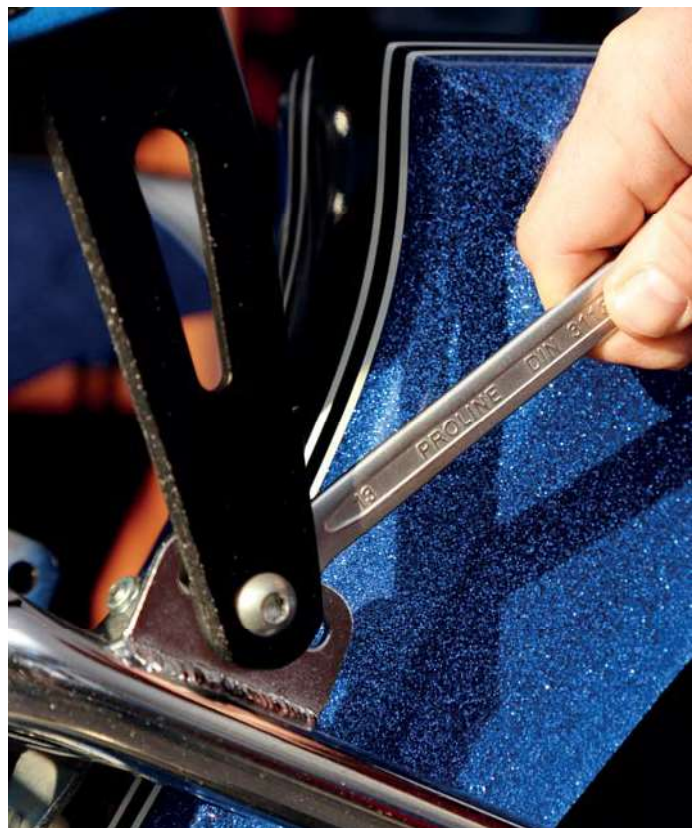

**1 'C' TYPE RING SPANNERS**

• КЛЮЧИ ГАЕЧНЫЕ НАКИДНЫЕ ИЗГНУТЫЕ (СТАРТЕРНЫЕ) • RINGSCHLÜSSEL TYP C

PROLINE HD®

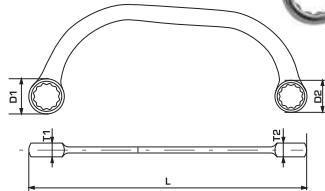

**CrV**  
6140 **HRC**  
46±2

• Forged • Chromium-plated • Satin

Code	Size (mm)	L (mm)	D1 (mm)	D2 (mm)	T1 (mm)	T2 (mm)		
36068	8 x 10	137	14.3	15.6	6.5	6.2	x	10/200
36070	10 x 12	141	18.2	15.6	6.6	6.5	x	10/200
36071	11 x 13	166	21.0	18.2	8.2	8.0	x	10/100
36073	13 x 15	190	25.0	22.0	9.2	8.2	x	10/100
36074	14 x 17	190	25.0	22.0	9.2	8.2	x	10/100
36079	19 x 22	256	32.5	28.6	11.1	10.1	x	6/60

**2 FLARE NUT SPANNERS**

• КЛЮЧИ ГАЕЧНЫЕ НАКИДНЫЕ С РАЗРЕЗОМ • DOPPELRINGSCHLÜSSEL

PROLINE HD®

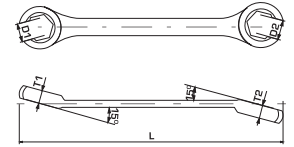

**CrV**  
6140 **DIN**  
3118 **HRC**  
46±2

• Forged • Chromium-plated • Satin

Code	Size (mm)	L (mm)	D1 (mm)	D2 (mm)	T1 (mm)	T2 (mm)		
36046	6 x 8	126	4.5	6.0	6.6	8.2	x	10/200
36048	8 x 9	145	6.0	6.5	7.0	8.5	x	10/200
36049	9 x 11	152	6.5	8.5	8.5	9.0	x	10/200
36050	10 x 12	152	7.0	9.0	8.5	9.0	x	10/200
36052	12 x 13	165	9.0	10.0	9.0	10.5	x	10/200
36053	13 x 14	178	10.0	11.0	9.5	11.0	x	10/100
36055	15 x 17	196	12.0	14.0	11.0	12.0	x	10/100
36059	19 x 21	233	15.0	16.0	14.0	16.0	x	10/60
36062	22 x 24	252	17.0	18.0	16.0	17.0	x	10/80

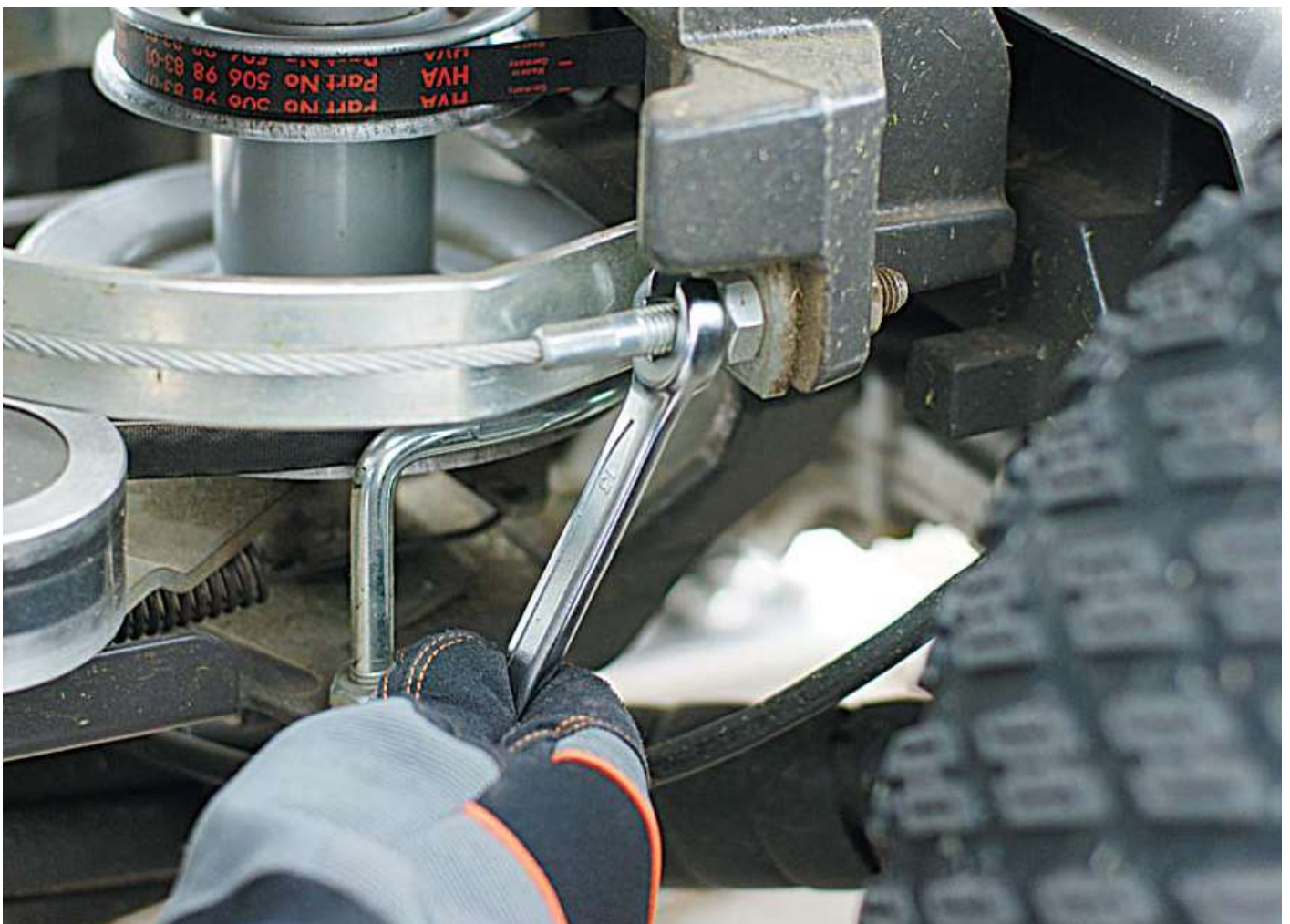

PROLINE

LANITI PRO

MEGA

JUCO

OTHER BRANDS

ERDI

KLINGSPOR

EXPRESS

ACTION CAN

TRYTON

VULCAN

### 1 RING TORX SPANNERS

• КЛЮЧИ НАКИДНЫЕ TORX • RING-TORXSCHLÜSSEL

PROLINE HD®

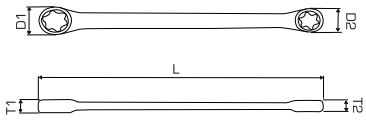

**10** years warranty  
CrV 6140 HRC 46±2

• Forged • Chromium-plated • Satin

Code	Size (mm)	L (mm)	D1 (mm)	D2 (mm)	T1 (mm)	T2 (mm)	BOX	BOX
36686	E6 x E8	113	11.2	9.2	5.6	4.6	x	20/200
36690	E10 x E12	142	16.7	14.4	7.8	6.5	x	20/200
36694	E14 x E18	182	21.2	17.2	9.8	8.2	x	20/200
36695	E20 x E24	224	28.7	24.8	13.0	11.0	x	10/100

### 2 RING TORX SPANNERS

• НАБОР КЛЮЧЕЙ НАКИДНЫХ TORX • RING-TORXSCHLÜSSEL

PROLINE HD®



• Forged • Chromium-plated • Satin  
• 4 pcs.: E6xE8, E10xE12, E14xE18, E20xE24 mm

**10** years warranty  
CrV 6140 HRC 46±2



Code	Quantity (pcs)	Range (mm)	BOX	BOX
36680	4	E6 x E8 - E20 x E24	x	10

### 3 FLEXIBLE SOCKET COMBINATION SPANNERS

• КЛЮЧИ ГАЕЧНЫЕ КОМБИНИРОВАННЫЕ РОЖКОВО-ТОРЦЕВЫЕ ШАРНИРНЫЕ • FLEXIBLE STECKSCHLÜSSEL-KOMBINATIONSSCHLÜSSEL

PROLINE HD®

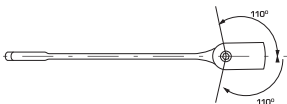
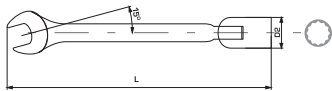

**10** years warranty  
CrV 6140 HRC 44±2

• Forged • Chromium-plated • Satin • Ground heads  
• Socket: 50BV30 • Head range of motion: 220° ±5°

Code	Size (mm)	L (mm)	D2 (mm)	BOX	BOX
36090	10	180	15	x	30/120
36093	13	210	19	x	25/100
36097	17	235	24	x	25/50
36099	19	235	26	x	25/50

### 4 FLEXIBLE SOCKET SPANNERS

• КЛЮЧИ ШАРНИРНО-ТОРЦЕВЫЕ • FLEXIBLE STECKSCHLÜSSEL

PROLINE HD®



**10** years warranty  
CrV 6140 HRC 44±2

• Forged • Chromium-plated • Satin • Ground heads • Socket: 50BV30  
• Head range of motion: 220° ±5°

Code	Size (mm)	L (mm)	D1 (mm)	D2 (mm)	BOX	BOX
36136	6 x 7	180	9.5	10.9	x	25/100
36138	8 x 9	180	13.0	14.0	x	25/100
36140	10 x 11	200	15.0	16.0	x	25/100
36142	12 x 13	220	18.0	19.0	x	30/120
36144	14 x 15	242	20.0	22.0	x	25/100
36146	16 x 17	254	24.0	24.0	x	25/50
36147	17 x 19	260	24.0	26.0	x	30/60
36148	18 x 19	275	26.0	26.0	x	25/50
36150	20 x 22	305	28.0	30.5	x	12/24
36151	21 x 23	305	29.8	33.0	x	12/24
36154	24 x 27	335	33.0	37.0	x	12/24
36160	30 x 32	350	40.0	42.0	x	6/12

### 5 FLEXIBLE SOCKET SPANNER SET

• НАБОР ГАЕЧНЫХ НАКИДНЫХ ИЗОГНУТЫХ (СТАРТЕРНЫХ) КЛЮЧЕЙ • FLEXIBLER STECKSCHLÜSSEL-SÄTZE

PROLINE HD®



• Forged • Chromium-plated • Satin  
• Ground heads • Socket: 50BV30  
• Head range of motion: 220° ±5°  
• 6 pcs.: 8x9, 10x11, 12x13, 14x15, 16x17, 18x19 mm



**10** years warranty  
CrV 6140 HRC 44±2

Code	Quantity (pcs)	Range (mm)	BOX	BOX
36166	6	8x9 - 18x19	x	12

**1 FLEXIBLE TORX SOCKET SPANNERS**

- КЛЮЧИ КОМБИНИРОВАННЫЕ ТОРЦЕВЫЕ- TORX ШАРНИРНЫЕ
- FLEXIBLE TORX-STECKSCHLÜSSEL

PROLINE HD®

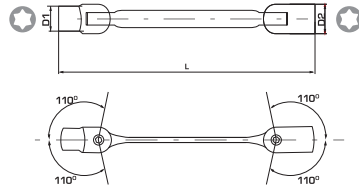

CrV  
6140

HRC  
44±2

- Forged • Chromium-plated • Satin • Socket: 50BV30 • Head range of motion: 220° ±5°

Code	Size (mm)	L (mm)	D1 (mm)	D2 (mm)		
36116	E6 x E8	182	8.3	9.9	x	25/100
36120	E10 x E12	200	12.0	15.0	x	25/100
36124	E14 x E16	220	16.3	19.0	x	25/100
36128	E18 x E20	240	20.5	22.0	x	25/50
36132	E22 x E24	258	25.0	26.0	x	25/50

**2 FLEXIBLE TORX SPANNERS**

- КЛЮЧИ ШАРНИРНЫЕ TORX • FLEXIBLE TORX-SCHLÜSSEL

PROLINE HD®

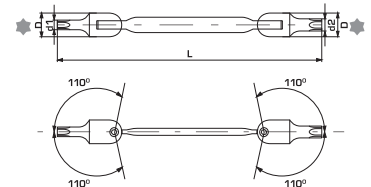

CrV  
6140

HRC  
44±2

- Forged • Chromium-plated • Satin • TORX: 8660V
- Head range of motion: 220° ±5°

Code	Size (mm)	L (mm)	d1 (mm)	d2 (mm)	D (mm)		
36106	T15 x T20	220	3.26	3.8	15	x	25/100
36107	T25 x T27	220	4.40	5.0	15	x	25/100
36108	T30 x T40	220	5.48	6.6	15	x	25/100
36109	T45 x T50	240	7.70	8.8	18	x	25/50
36110	T55 x T60	240	11.17	13.2	18	x	25/50



**3 FLEXIBLE TORX SPANNER SET**

- НАБОР КЛЮЧЕЙ ШАРНИРНЫХ TORX • FLEXIBLER TORX-SCHLÜSSELSATZ

PROLINE HD®



CrV  
6140

HRC  
44±2

- Forged • Chromium-plated • Satin • Head range of motion: 220° ±5° • The maximum torque is 30% higher than in German DIN 896 standard
- 5 pcs.: T15xT20, T25xT27, T30xT40, T45xT50, T55xT60

Code	Quantity (pcs)	Range (mm)		
36105	5	T15xT20 - T55xT60	x	12

## X-ON Electronics

Largest Supplier of Electrical and Electronic Components

*Click to view similar products for [Screwdrivers, Nut Drivers & Socket Drivers](#) category:*

*Click to view products by [Proline](#) manufacturer:*

Other Similar products are found below :

[1406504-2](#) [2-21006-8](#) [27850](#) [CE-16-03400-00-HNDLE-TORQ](#) [30246](#) [323451-000](#) [46722](#) [16538](#) [XW4Z-00B](#) [96025](#) [96030](#) [96560](#) [96703](#)  
[96430](#) [31830](#) [92270](#) [96012](#) [96436](#) [96536](#) [92064](#) [92008](#) [72820](#) [92005](#) [76070](#) [96520](#) [92040](#) [36372](#) [96416](#) [92024](#) [96420](#) [76005](#) [96570](#)  
[72823](#) [96325](#) [96525](#) [96720](#) [31832](#) [76019](#) [92004](#) [76007](#) [92069](#) [92020](#) [76021](#) [96523](#) [96510](#) [96427](#) [96425](#) [96415](#) [96320](#) [92073](#)