

MLCC



CHIP-R



COIL



ABOUT PDC

Milestone 歷史沿革



1990	PDC former parent company, Taiwan Cement, merged with Mei Da Mei and founded PDC in Nantou. 台泥集團購買美大美電子公司，信昌電子陶瓷正式成立。
1995	PDC merged with Taiwan Precision Material Corporation. 信昌電子陶瓷併購台灣精密材料公司。
2002	Public Listed in OTC. 信昌電子陶瓷正式上櫃。
2005	PDC was strategically allied with Wasin Tech. 與華新科技(股)公司策略聯盟。
2007	To be strategically allied with Frontier, and setting up new production lines, Magnetic components. 與弘電電子工業(股)公司策略聯盟，生產磁性材料元件。
2008	Positioned as Specialty and Material BG in PSA Group. 集團推動 PSA 被動系統聯盟企業識別，信昌電子陶瓷定位為特殊品及材料事業群。

Core Technology 關鍵技術



1988	Manufacturing and developing ceramic dielectric materials. 生產製造圓板電容粉末、開發。
1990	Manufacturing Multilayer Ceramic Capacitors. 生產製造積層陶瓷晶片電容。
1995	Manufacturing Ceramic Chip Resistors and Ceramic Chip Coil 生產陶瓷晶片電阻、陶瓷晶片電感。
2001	As the 1 st manufacturer and provider in Taiwan for ceramic dielectric powders and multilayer ceramic chip capacitors (MLCC). 臺灣第一家自行供給晶片電容器介電瓷粉之被動元件廠商。
2001	With self-made conducting dielectric powder, controlling the complete key technology from material to manufacture. 自製半導體介電瓷粉，掌握由材料至製程的完整關鍵性技術。
2007	Manufacturing magnetic components. 生產磁性材料元件。

Brand Value 品牌價值



2001	The first supplier in Asia to get SEMKO product safety certificate. 亞洲第一家獲得 SEMKO 安全規格認證之供應商。
2003	ISO 9001 certificated. 獲 ISO 9001 驗證通過。
2004	Industrial Sustainable Excellence Award. 榮獲經濟部工業局工業精銳獎。
2004	TS16949、ISO 14000 and OHSAS 18000 certificated. 獲 TS16949、ISO 14000 及 OHSAS 18000 驗證。
2007	Common Wealth Magazine Top 1000 Manufacturers in Taiwan Ranked in No. 705. 天下雜誌 1000 大製造業排名第 705 名。
2008	IECQ QC080000 HSF certificated. 獲 IECQ QC080000 HSF 驗證。 Common Wealth Magazine Top 1000 Manufacturers in Taiwan Ranked in No. 682. 天下雜誌 1000 大製造業排名第 682 名。
2009	Common Wealth Magazine Top 1000 Manufacturers in Taiwan Ranked in No. 677. 天下雜誌 1000 大製造業排名第 677 名。
2012	Recognition of Winning the Silver Invention Award for Copper or Its Alloy Cofirable Dielectric Ceramics. 榮獲國家發明創作獎 - 發明獎銀牌「可與銅及其合金進行共燒製作的介電陶瓷組成物」
2013	SMD High Voltage Chip Resistor passed UL Safety certification in 2013 電阻產品取得安規認證證書
2015	MLCC product have obtained the IECQ certificate & the certificate of AS9100 management system for the aerospace industry. 通過 IECQ 第三方認證及 AS9100 航太工業管理系統驗證。
2016	Aerospace Quality Management Systems AS 9100 certificated. 晶片電容取得車規第三方認證
2019	PDC was selected fastest growing Top 100 companies in 2019 by commonwealth magazine PDC 榮獲天下雜誌 2019 年成長 100 強企業

Market Performance 市場表現



The only local manufacturer in Taiwan with the capability in specialty products includes multiple-layer ceramic capacitors, chip resistors, and coils.
國內唯一可全數提供特殊電容、電感、電阻之被動元件供應商。
The only local manufacturer in Taiwan entered the supply chain of Japan market.
國內唯一打入日本供應鏈之廠商。

Introduction

Prosperity Dielectrics Co., Ltd. (PDC) was founded in 1990 as the 1st local manufacturer and exporter in Taiwan for ceramic dielectric powders and multiple-layer ceramic chip capacitors (MLCCs). PDC joined to Walsin Technology Corporation (WTC) as an allied company in September 2005, and incorporated Frontier to create solid synergy in 2008. Our product lines expand to SMD magnetic chips, power chokes, coils and transformers.

信昌電子陶瓷成立於 1990 年，為國內少數能自行供給瓷粉原料並同時銷售積層陶瓷電容的被動元件廠商，更是唯一有能力由上游初發原料，向下垂直整合至被動晶片元件的廠商。2005 年信昌電陶與華新集團進行策略聯盟、2008 年正式合併弘電電子，將銷售範圍從介電瓷粉、半導體陶瓷電容器瓷片、積層陶瓷電容、晶片電阻延伸到線圈，成為國內唯一可全數提供特殊電容、電感、電阻之被動元件供應商。

Support You Forward

With niche technology of key materials, PDC can meet the market requirements. The integration of researching and developing from materials to the customer-required components can shorten the time of mass production. To progressively make plans for each product to be with high added value functions, such as Mid and high voltage, high precision, large size capacitors, and high power, high precision, low resistance resistors or other high added value products. In the future, combine with core material technology and advance high frequency and high capacitance further.

由於掌握關鍵性材料的技術利基，信昌電陶可配合市場需求，由材料研發著手，向下整合開發客戶所需要的電子元件，縮短量產時效，並積極規劃各項產品朝高附加價值的零件功能領域邁進，如：中高壓、高精度、大尺寸之晶片電容器及高功率、高精度與低阻值之晶片電阻器等高附加價值產品。未來更將結合材料核心技术，進軍高頻及高容領域。

At present, PDC has developed ceramic dielectric powder used by NME and BME manufacturing process. Self-applied mass production and external sale are simultaneously carried out to improve the proportion to the supply of internal high-level MLCC materials. By the strategy of vertical production capability from ceramic dielectric powder material to MLCC finished goods, bring the high performance of vertical integration.

目前信昌電陶貴金屬製程及卑金屬製程 (BME) 使用的晶片電容器介電瓷粉已陸續開發完成，量產自用與對外銷售並行展開，提升國內高階積層電容瓷粉原料自主供應比率。藉由原料往下游整合至晶片電容器成品的延伸策略，發揮上下垂直整合的高度營運績效。

For the past few years, to extend the production capability of magnetic components series, PDC gradually set up the manufacturing equipments for coil and transformer in Yongzhou and Shenzhen Plant. The improvement of the production capability is able to increase the sales performance.

近年來，為了擴展磁性元件系列產品的產能，信昌電陶陸續在中國永州廠、深圳廠增置電感、變壓器相關製造設備，藉由產能提升，大幅拉升業績。

Vertical integration & Complete key technology:

- Material (Ceramic Dielectric Powder)
- Semi-finished good (Semiconducting Ceramic Chip Capacitor)
- Finished goods (Chip Capacitor, Chip resistor, Coil)

上下游垂直整合，掌握完整關鍵性技術：

- 原料 (介電瓷粉)
- 半成品 (半導體陶瓷電容瓷片)
- 成品 (晶片電容、晶片電阻、線圈)

Business Operation 經營模式分析

- Vertical integration to improve competitiveness.
- Building strategic alliances to strengthen competitiveness.
- Expanding Western and Japanese markets, cultivation high-end products.
- Moving into Chinese market to expand market share.
- 垂直整合發展，擺脫同業競爭
- 運用策略聯盟，產品水平延伸
- 拓展歐美日市場，深耕高階產品
- 跨足中國市場，擴大市佔率

Branding Strategy 品牌經營策略

- Developing specialized products market.
- Enhancing brand value with continuing innovation and R&D ability.
- Improving competitiveness through vertical integration.
- Satisfying customer's need through extending product lines.
- 深耕被動元件特殊品市場及其上游材料產業高階產品
- 持續創新研發能力，提升品牌價值
- 產品垂直整合，強化競爭優勢
- 產品水平延伸，滿足客戶一次購足

Key to the Success 關鍵成功因素

- The only local manufacturer with vertical production capability from ceramic dielectric powder material to multiple-layer ceramic chip capacitors.
- Differentiating marketing strategy with niche product.
- Diversifying product lines to expand customer base.
- Continuing innovation and R&D ability.
- Focusing core competence with PSA group support.
- 國內唯一有能力由上游初發原料，向下垂直整合至被動晶片元件的廠商，掌握材料與製程的完整關鍵性技術
- 利基產品差異化與行銷差異化策略
- 產品線多元發展，擴大客戶群
- 持續創新與研發，開發新產品與導入新製程
- 共享集團資源，聚焦核心競爭力

Characteristics 企業特色

- PDC is the domestic manufacturer devoting to ceramic dielectric materials.
- 為國內廠商對介電瓷粉材料研發投資最深者

Notice for PDC Products

❑ Please read this notice before using the PROSPERITY DIELECTRICS CO., LTD.. products.

- Product information in this catalog is updated in Mar. 2020. All of the contents specified herein are subjected to change without notice due to technical improvements, etc. Therefore, please check for the latest information carefully before practical application or usage of the Products.
Please note that PROSPERITY DIELECTRICS CO., LTD. shall not be responsible for any defective which is caused by using products without the spec instruction.
- Please contact PROSPERITY DIELECTRICS CO., LTD. for further details of product specifications as the individual specification is available.
- Please conduct validation and verification of products in actual condition of mounting and operating environment before commercial shipment of the equipment.
- All electronic components listed in this catalog are developed, designed and intended for use in general electronics equipment.(for AV, office automation, household, office supply, information service, telecommunications, (such as mobile phone or PC) etc.). Before incorporating the components or devices into any equipment in the field such as transportation,(automotive control, train control, ship control), transportation signal, disaster prevention, medical, public information network (telephone exchange, base station) etc. which may have direct influence to harm or injure a human body, please contact PROSPERITY DIELECTRICS CO., LTD. for more detail in advance.
- Do not incorporate the products into any equipment in fields such as aerospace, aviation, nuclear control, submarine system, military, etc. where higher safety and reliability are especially required.
- In addition, even electronic components or functional modules that are used for the general electronic equipment, if the equipment or the electric circuit require high safety or reliability function or performances, a sufficient reliability evaluation check for safety shall be performed before commercial shipment and moreover, due consideration to install a protective circuit is strongly recommended at customer's design stage.
- The contents of this catalog are applicable to the products which are purchased from our sales offices or distributors (so called "PDC's official sales channel").
- It is only applicable to the products purchased from any of PDC's official sales channel.
- Please note that PROSPERITY DIELECTRICS CO., LTD. shall have no responsibility for any controversies or disputes that may occur in connection with a third party's intellectual property rights and other related rights arising from your usage of products in this catalog. PROSPERITY DIELECTRICS CO., LTD. grants no license for such rights.
- The information of this specification is for reference. For more detailed specification, please refer to the official qualified data.

有關本公司產品的注意事項

❑ 請務必在使用本公司產品目錄之前閱讀。

- 本注意事項中記載的內容是2020年3月現在的內容。本產品目錄記載的內容由於產品的改良等原因發生變更時，恕不另行通知。在您定購我司產品之前請確認最新的產品資訊。
當您於《產品規格書》以外使用我司產品時，所引起應用設備的瑕疵我司將不承擔任何責任。
- 有關詳細產品規格我們準備有《產品規格書》，請向我司諮詢相關事宜。
- 在您使用我司產品時，請務必進行應用設備實裝狀態以及應用產品實際使用環境下的測評。
- 本目錄中電子零組件，適用於一般電子設備。『AV設備，OA設備，家電及辦公設備，資訊/通訊設備（手機，電腦等）』當您計畫把本產品目錄中記載的產品使用於可能會危及第三方生命安全的應用設備時，請務必提前與我公司取得聯繫，針對產品資訊加以確認。

- 【運輸用設備（火車控制設備，船舶控制設備等），交通用信號設備，防災設備，醫療用設備，公共性高的資訊通信設備..等（電話程式控制交換機，電話，無線電，電視信號等基地局）】另外，請不要在要求高度安全性，可靠性的應用設備上使用本產品目錄中記載的產品。【航太設備，航空設備，核控制設備，用於海底的設備，軍事設備等】同時，應用於安全性，可靠性要求較高的一般電子設備/電路時，請充分進行安全性測評，必要時請在設計過程中追加保護電路。
- 本目錄中所記載的內容適用於透過我司營業據點，銷售子公司，正式銷售代理商（即正規銷售管道）購買的我司產品。通過其他管道所購買的我司產品不在適用範圍之內。
- 由於使用本目錄記載的產品引起的有關第三方智慧財產權的衝突，我司概不負責。本產品目錄不代表相關權利的實施許諾。
- 內部記載之產品規格僅提供參考，實際規格請依照我司標準承認書為準。

Chip R-Contents

Series	Description	Automotive	Resistance Range	Tolerance(%)	TCR (ppm/°C)	Power Rating	Size	Page
Current Sensing Low R								
FMF	Metal Strip Low Ohm Current Sense Chip Resistor	V	0Ω ; 1m~*220mΩ	±1%, ±5%	±50~±100	1/2 ~ 3W	1206/2512	56
FBF	Metal Paste Low Ohm Current Sense Chip Resistor		10m~910mΩ	±1%, ±5%	±100~±200	1/8 ~ 2W	0603 ~ 2512	58
FOF	Metal Foil Low Ohm Current Sense Chip Resistor		2m~700mΩ	±0.5%, ±1%, ±5%	±50~±100	1/2 ~ 2W	0402 ~ 2512	59
FPF-L	Thick Film High Power Low Ohm Current Sense Chip Resistor	V	50m~910mΩ	±1%, ±5%	±100~±250	1/4~ 2W	0603 ~ 2512	60
	Thick Film Triple Power Low Ohm Current Sense Chip Resistor	V	100m~910mΩ	±1%, ±5%	±100~±200	3W	2512	
FCF-E	Thick Film Low Ohm Current Sense Chip Resistor		50m~910mΩ	±1%, ±5%	±200~±400	1/8 ~ 1W	0603 ~ 2512	61
Anti-Surge & Speciality & High Reliability								
FPF	Thick Film High Power Chip Resistor	V	0Ω ; 1~1MΩ	±1%, ±5%	±100~±200	1/8 ~ 2W	0603 ~ 2512	62
	Thick Film Triple Power Chip Resistor	V	0Ω ; 1~1MΩ	±1%, ±5%	±100~±200	1/3W ~ 3W	0603 ~ 2512	
FPS	Thick Film Power Surge Chip Resistor	V	0Ω ; 1~1MΩ	±1%, ±5%	±100~±200	1/8 ~ 2W	0603 ~ 2512	63
	Thick Film Triple Power Surge Chip Resistor	V	1~1MΩ	±1%, ±5%	±100~±200	1/3W~3/4W	0603 ~ 1206	
FNF	Thick Film Anti-Surge Chip Resistor	V	1~1MΩ	±5% ~ ±20%	±100	1/10~1W	0603 ~ 2512	64
FHF	Thick Film High Ohm Chip-Resistor	V	11M~100MΩ	±1% ~ ±5%	±200~±300	1/16~1/4W	0402 ~ 1206	65
FGF	Thick Film Non-Magnetic Chip-Resistor		0Ω ; 1~10MΩ	±1% ~ ±5%	±100~±200	1/10~1/4W	0603 ~ 1206	66
High Voltage								
FVS	Thick Film High Voltage Chip Resistor UL Safety Certification 	V	100K~100MΩ	±1%, ±5%	±100~±200	1/10~1W	0603 ~ 2512	67
FVF	Thick Film High Voltage Chip Resistor	V	100K~100MΩ	±1%, ±5%	±100~±200	1/10~1W	0603 ~ 2512	68
Automotive								
FWF	Thick Film Automotive Chip Resistors	V	0Ω ; 1~10MΩ	±1%, ±5%	±100~±200	1/16 ~ 1W	0402 ~ 2512	69
Normal Type								
FCF	Thick Film General Purpose Chip Resistor		0Ω ; 1~10MΩ	±0.1% ~ ±5%	±25~±300	1/32 ~ 1W	01005 ~ 2512	70
FCF-Array	Thick Film Chip Resistor Array		0Ω ; 10~1MΩ	±1% ~ 5%	±200~±300	1/16 ~ 1/10W	Convex / Concave	72
Green								
FCF-G	Thick Film General Purpose Chip Resistor LF <100ppm		1~10MΩ	±1% ~ ±5%	±100~±300	1/16 ~ 1W	0402 ~ 2512	73
High Precision								
FAF	Thin Film Precision Chip Resistor	V	1~3MΩ	±0.01% ~ 1%	±2 ~ ±50	1/32 ~ 1W	0201 ~ 2512	75
APPENDIX								78

MLCC

Chip R

Coil

FMF

■ Metal Strip Type Lead Free Current Sensing Resistors

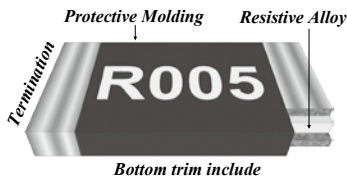

FEATURES

- High power rating and low TCR.
- Low resistance and high precision (1%).
- Low inductance design, less than 1.0nH available.
- Inductance less than 1.0nH.
- Excellent reliability and suitable cost.
- Suitable for lead free soldering.
- High precision trimming implement.
- RoHS compliant & Halogen Free.

APPLICATION

- Switching model power supply.
- Battery pack.
- Notebook, Tablet PC.
- Test Instrument.
- Power Amplifier.

PART NUMBER

FMF	25	F	P	J	R005	-	BH
Type □□□	Size □□	Tolerance □	Packing □	Watt □	R Value □□□□	TCR □	Special Code
FMF Metal strip	06 1206 25 2512	F = ±1% G = ±2% J = ±5%	T = Paper Tape 4Kpcs (For 1206) 5Kpcs (1206_K) P = Plastic Tape 4Kpcs (For 2512)	F = 1/2W H = 1W I = 1.5W J = 2W K = 3W	XXXX 4 digit Jumper : 000_ _ : means blank.	"-" Standard X = code of 2512 R001. R002.	LH = Standard BH = Low EMF K = K Type AEC-Q200 LHM = Standard BHM = Low EMF

RATING

Type	Power Rating @ 70°C	Max. Working Current (Voltage)*	Max. Overload Current (Voltage)*	Alloy Type	Resistance Tolerance (%)	Temperature Coefficient of Resistance (ppm/°C)	Resistance (mΩ)
FMF06 1206	0.5W	12.9A (111mV)	28.9A (250mV)	Low EMF	±1%(F) ±2%(G) ±5%(J)	±70	3, 4, 5, 6, 7, 8, 9, 10, 15, 20, 25
		10.0A (111mV)	22.4A (250mV)	Standard		±50	5, 10, 15, 15.5, 18, 20, 25, 30
	1W	18.3A (158mV)	40.8A (354mV)	Low EMF		±70	3, 4, 5, 6, 7, 8, 9, 10, 15, 20, 25
		14.1A (173mV)	31.6A (387mV)	Standard		±50	5, 10, 15, 15.5, 18, 20, 25, 30
FMF25 2512	1W	31.6A (158mV)	70.7A (354mV)	Low EMF	±1%(F) ±2%(G) ±5%(J)	±70	1, 2, 2.5, 3, 4, 5, 10, 15, 20, 25
		18.3A (469mV)	40.8A (1049mV)	Standard		±50	3, 4, 5, 6, 7, 8, 9, 10, 12, 15, 20, 22, 25, 30 33, 35, 40, 50, 60, 70, 75, 80, 100, *200, *220
	2W	44.7A (224mV)	100A (500mV)	Low EMF		±70	1, 2, 2.5, 3, 4, 5, 10, 15, 20, 25
		25.8A (663mV)	57.7A (1483mV)	Standard		±50	3, 4, 5, 6, 7, 8, 9, 10, 12, 15, 20, 22, 25, 30 33, 35, 40, 50, 60, 70, 75, 80, 100, *200, *220
	3W	31.6A (245mV)	70.7A (548mV)	Low EMF		±70	1, 2, 3, 4, 5, 6, 7, 8, 9, 10
		24.5A (812mV)	54.8A (1817mV)	Standard		±50	20 5, 6, 8, 10 12, 14, 15, 16, 18, 20, 25, 30, 33, 35, 40, 50 60, 75, 80, 100, *200, *220

Note : *200, *220 Under develop

K TYPE

Type	Power Rating @ 70°C	Max. Working Current*	Max. Overload Current* (2 sec)	Tolerance (%)	Temperature Coefficient of Resistance (ppm/°C)**	Resistance (mΩ)***
FMF06_K	1W	31.6A	79.1A	±1%(F) ±5%(J)	±100	1
		22.4A	55.9A		±70	2
	1.5W	38.7A	96.8A		±70	1
		27.4A	68.5A		±70	2
FMF25_K	2W	63.2A	158.1A	±5%(J)	±70	0.5

Note :

(1) RCWW = (P × R)^{1/2} or Max. RCWW listed above, whichever is lower.

RCWW : Rated Continue Working Voltage(V) · P : Rated Power(W) · R : Resistance Value(Ω)

(2) Solder-pad and trace size should be >300 mm² and board surface temperature should not exceed 105°C when applying rated power

(3) * : Related number are depend on specific items only.

** : TCR Hot (+25~+155°C).

*** : Special requests and details please contact factory.

■ Metal Strip Type Lead Free Current Sensing Resistors

Metal Jumper

Type	Max. Working Current	Max. Overload Current	Resistance
FMF06 1206 (FMF06JTH000-LH)	80A	100A	Max. 0.2mΩ
FMF25 2512 (FMF25JPJ000-LH)	120A	150A	Max. 0.1mΩ

GUIDE OF CURRENT SENSING RESISTORS

Series	Product Type	Resistance Range (<1 Ω)	Power Type	AEC Q200
FMF	Metal Strip	0mΩ~220mΩ	V	V
FOF	Metal Foil	2mΩ~700mΩ	V	
FBF	Metal Paste	10mΩ~910mΩ	V	
FPF	High Power	50mΩ~910mΩ	V	V
FCF-E	Normal	50mΩ~910mΩ		

DIMENSIONS

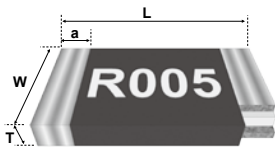

For FMF25 1m~2m & K Type

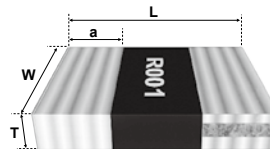

Note. Precise data please refer detail spec. unit: mm

Type	L	W	T	a
FMF06 3m~30m	3.10±0.20	1.65±0.20	0.60±0.20	0.60±0.20
FMF25 2.5m~220m	6.20±0.20	3.25±0.20	0.60±0.20	0.80±0.20
FMF25 3m~220m 3W	6.20±0.20	3.25±0.20	0.65±0.20	0.80±0.20

FMF25 1m~2m unit: mm

Type	L	W	T	a
FMF25 1m~2m	6.40±0.20	3.25±0.20	0.70±0.20	2.00±0.20
FMF25 1m~2m 3W	6.40±0.20	3.25±0.20	0.80±0.20	2.00±0.20

KTYPE unit: mm

Type	L	W	T	a	Marking
FMF06 1mΩ	3.20±0.15	1.60±0.15	0.32±0.15	1.10±0.25	01
FMF06 2mΩ	3.20±0.15	1.60±0.15	0.32±0.15	0.50±0.25	02
FMF25_K 0.5m	6.30±0.25	3.10±0.25	0.58±0.15	2.20±0.25	0L50

POWER DE-RATING CURVE

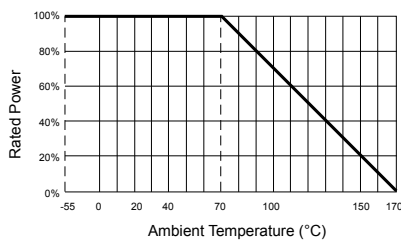

Operating Temperature Range: -55 to +170 deg.C

FBF

■ Metal Paste Type High Power Lead Free Chip Resistors

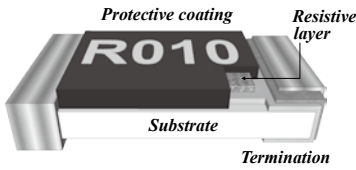

FEATURES

- Low resistance and high precision (1%).
- Excellent reliability and suitable cost.
- Suitable for lead free soldering.
- RoHS compliant & Halogen Free.

APPLICATION

- Consumer electronics, M/B.
- Battery pack, BTC.
- Notebook, Tablet PC.
- Portable Device, Electroni Equipment.

PART NUMBER

FBF	25	F	P	P	R100	TCR	Special Code
Type □□□□	Size □□	Tolerance □	Packing □	Watt □	R Value □□□□		
FBF Metal Paste	03 0603 05 0805 06 1206 12 1210 20 2010 25 2512	F = ±1% G = ±2% J = ±5%	T = Paper Tape 5Kpcs P = Plastic Tape 4Kpcs	"-" = Standard *P = Power Enhance	XXXX 4 digit	No special code- Null special code- "-"	"Null" Standard K: R010~R018 Controlcode

RATING

Type	Normal Type Power Rating @ 70°C	Power Type Rating Power @ 70°C	Resistance Tolerance (%)	Temperature Coefficient of Resistance (TCR; ppm/°C)	Resistance Range (mΩ)		Standard Resistance Values
					Min.	Max.	
FBF03 0603	1/8W	*1/4W	±1%, ±2%, ±5%	±200 ±100	40 100	91 910	
FBF05 0805	1/4W	*1/2W	±1%, ±2%, ±5%	±400~±200 ±100	10 47	46 910	E-24
FBF06 1206	1/3W	*3/4W	±1%, ±2%, ±5%	±400~±200 ±100	10 47	46 910	Special Request
FBF12 1210	2/3W	*3/4W	±1%, ±2%, ±5%	±400~±200 ±100	10 47	46 910	Please Contact Factory
FBF20 2010	3/4W	*1W	±1%, ±2%, ±5%	±400~±200 ±100	10 47	46 910	
FBF25 2512	1W	*2W	±1%, ±2%, ±5%	±400~±200 ±100	10 47	46 910	

Note: (1) RCWV = (P×R)^{1/2} or Max. RCWV listed above, whichever is lower.

RCWV : Rated Continue Working Voltage(V) · P : Rated Power(W) · R : Resistance Value(Ω)

(2) Above 2512 size, solder-pad and trace size should be >300 μm² and board surface temperature should not exceed 105°C when applying full rated power.

GUIDE OF CURRENT SENSING RESISTORS

Series	Product Type	Resistance Range (<1 Ω)	Power Type	AEC Q200
FMF	Metal Strip	0mΩ~220mΩ	V	V
FOF	Metal Foil	2mΩ~700mΩ	V	
FBF	Metal Paste	10mΩ~910mΩ	V	
FPF	High Power	50mΩ~910mΩ	V	V
FCF-E	Normal	50mΩ~910mΩ		

DIMENSIONS

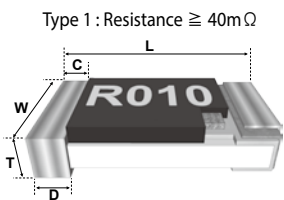

Type 1 : Resistance ≥ 40mΩ

unit: mm

Type 1	L	W	C	D	T
FBF03	1.60±0.10	0.80±0.10	0.30±0.20	0.30±0.20	0.45±0.10
FBF05	2.00±0.10	1.25±0.10	0.40±0.20	0.40±0.20	0.50±0.10
FBF06	3.10±0.10	1.60±0.10	0.50±0.25	0.50±0.25	0.55±0.10
FBF12	3.10±0.10	2.60±0.10	0.50±0.25	0.50±0.25	0.55±0.10
FBF20	5.00±0.20	2.50±0.20	0.60±0.25	0.60±0.25	0.60±0.10
FBF25	6.30±0.20	3.10±0.20	0.60±0.25	0.90±0.25	0.60±0.15

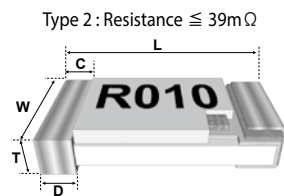

Type 2 : Resistance ≤ 39mΩ

unit: mm

Type 2	L	W	C	D	T
FBF03	1.60±0.10	0.80±0.10	0.30±0.20	0.50±0.20	0.50±0.10
FBF05	2.00±0.10	1.25±0.10	0.40±0.20	0.65±0.20	0.60±0.10
FBF06	3.10±0.10	1.60±0.10	0.50±0.25	0.90±0.25	0.65±0.10
FBF12	3.10±0.10	2.60±0.10	0.50±0.25	0.90±0.25	0.65±0.10
FBF20	5.00±0.20	2.50±0.20	0.60±0.25	1.25±0.25	0.65±0.10
FBF25	6.30±0.20	3.10±0.20	0.60±0.25	1.90±0.25	0.65±0.15

POWER DE-RATING CURVE

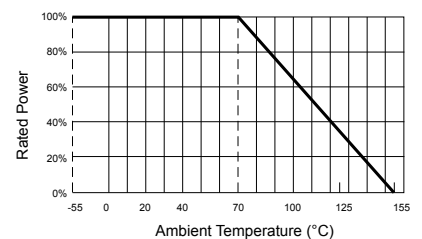

Maximum dissipation in percentage of rated power as a function of the ambient temperature for 0603, 0805, 1206, 1210, 2010, 2512

Power/Anti-Sulfur Lead Free Current Sensing Resistors

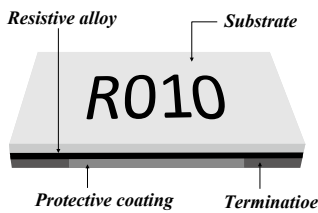

FEATURES

- Ultra low and stable TCR performance.
- High power rating and compact size.
- High reliability and stability.
- Reduced size of final equipment.
- RoHS exemption free & Lead free.
- ASTM B-809 105C 1000hrs compliant.

APPLICATION

- Power supply.
- PDA.
- Digital meter.
- Computer.
- Automotives.
- Battery charger.
- DC-DC power converter.

PART NUMBER

FOF	25	F	P	J	R005	N	SS
Type □□□	Size □□	Tolerance □	Packing □	Watt □	R Value □□□□	TCR □	Special Code □□
FOF Metal Foil	02 0402 03 0603 05 0805 06 1206 25 2512	D = ±0.5% F = ±1% J = ±5%	T =Paper tape – 5 Kpcs V =Paper tape – 10Kpcs P =Plastic tape – 4Kpcs	E =1/3W F =1/2W G =3/4W H =1W J =2W	XXXX 4 digit	N =100PPM X =70ppm P =50PPM	SS : Standard

RATING

Series No.	FOF25	FOF06	FOF05	FOF03	FOF02
Size code	2512 (6432)	1206 (3216)	0805 (2012)	0603 (1608)	0402 (1005)
Resistance Tolerance	±5%, ±1%, ±0.5% (only for TC50)				
Resistance Range	2~450, 700 mΩ	3~700 mΩ	3~500 mΩ	5~75 mΩ	5~25 mΩ
TCR (ppm/°C)	2~9mΩ: ±100 10~700mΩ: ±50	3~9mΩ: ±100 10~700mΩ: ±50	3~9mΩ: ±100 10~500mΩ: ±50	5~9mΩ: ±100 10~75mΩ: ±50	5~25mΩ: ±100
Max. power at Tamb=70°C	2W	1W	3/4W	1/2W	1/3W
Operation Temperature	-55 ~ +155°C				

Note : (1) Max. Operation Current : So called RCWC (Rated Continuous Working Current) is determined by $RCWC = \sqrt{\text{Rated Power} / \text{Resistance Value}}$ listed above

GUIDE OF CURRENT SENSING RESISTORS

Series	Product Type	Resistance Range (<1 Ω)	Power Type	AEC Q200
FMF	Metal Strip	0mΩ~220mΩ	V	V
FOF	Metal Foil	2mΩ~700mΩ	V	
FBF	Metal Paste	10mΩ~910mΩ	V	
FPF	High Power	50mΩ~910mΩ	V	V
FCF-E	Normal	50mΩ~910mΩ		

DIMENSIONS

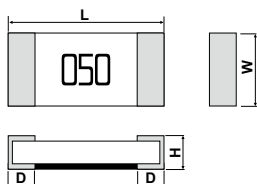

Type	R-value	L	W	H	D
FOF25	R002	6.4±0.30	3.2±0.30	0.65±0.20	2.8±0.30
	R003	6.4±0.30	3.2±0.30	0.65±0.20	2.6±0.30
	R004-R009	6.4±0.30	3.2±0.30	0.65±0.20	1.05±0.30
	R010-R049	6.4±0.30	3.2±0.30	0.65±0.20	1.05±0.30
	R050-R700	6.4±0.30	3.2±0.30	0.65±0.20	1.05±0.30
FOF06	R003	3.3±0.20	1.7±0.20	0.65±0.20	1.20±0.30
	R004-R008	3.3±0.20	1.7±0.20	0.65±0.20	0.68±0.30
	R009-R049	3.3±0.20	1.7±0.20	0.65±0.20	0.68±0.30
	R050-R700	3.3±0.20	1.7±0.20	0.65±0.20	0.68±0.30
	R003	2.10±0.20	1.35±0.20	0.65±0.20	0.65±0.20
FOF05	R004	2.10±0.20	1.35±0.20	0.65±0.20	0.50±0.20
	R005-R007	2.10±0.20	1.35±0.20	0.65±0.20	0.50±0.20
	R008-R049	2.10±0.20	1.35±0.20	0.65±0.20	0.50±0.20
	R050-R500	2.10±0.20	1.35±0.20	0.65±0.20	0.50±0.20
	R005	1.7±0.20	0.9±0.20	0.65±0.20	0.50±0.20
FOF03	R006-R009	1.7±0.20	0.9±0.20	0.65±0.20	0.40±0.20
	R010-R049	1.7±0.20	0.9±0.20	0.65±0.20	0.40±0.20
	R050-R075	1.7±0.20	0.9±0.20	0.65±0.20	0.40±0.20
	R005-R025	1.0±0.10	0.55±0.10	0.30±0.05	0.23±0.10

POWER DE-RATING CURVE

Operating Temperature Range: -55 to +155 deg.C

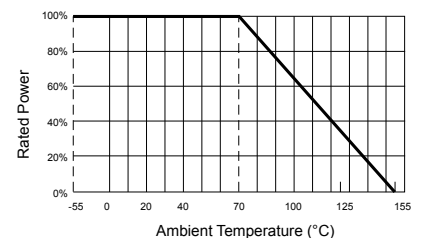

Maximum dissipation in percentage of rated power as a function of the ambient temperature

FPF-L

Current Sensing Thick-film Power Type Chip Resistors

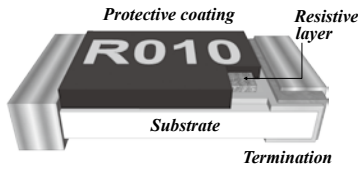

FEATURES

- High power rating to 2W and low TCR.
- Low resistance and high precision (1%).
- Excellent reliability and suitable cost.
- Suitable for lead free soldering.
- Meet AEC-Q200, RoHS compliant & Halogen Free.

APPLICATION

- Consumer electronics, M/B.
- Battery pack, BTC.
- Notebook, Tablet PC.
- Portable Device, Electronic Equipment.

PART NUMBER

FPF	25	F	P	-	R005	-	M
Type □□□	Size □□	Tolerance □	Packing □	Watt □	R Value □□□□	TCR	Special Code
FPF Thick Film High Power Low ohm	03 0603 05 0805 06 1206 12 1210 20 2010 25 2512	F = ± 1% G = ± 2% J = ± 5%	T = Paper tape – 5 Kpcs V = Paper tape – 10Kpcs W = Paper tape – 20Kpcs P = Plastic tape – 4Kpcs X = Plastic tape – 8Kpcs Y = Plastic tape – 16Kpcs Q = Plastic tape – 3 Kpcs (For 2512 3W)	"-" Standard Power boost code K = 3W (2512)	XXXX 4 digit	No special code- Null special code- "-" Power boost code N = 100ppm L = 200ppm	"Null" Standard M: Meet AEC-Q200

RATING

Type	Normal Type Power Rating @ 70°C	Max. RCWV (mV)	Max. Overload Voltage (mV)	Resistance Tolerance (%)	Temperature Coefficient of Resistance (TCR; ppm/°C)	Resistance Range (mΩ)		Standard Resistance Values
						Min.	Max.	
FPF03 0603	1/4W	477	1066	±1%, ±5%	±250 ±150*	50 100	91 910	E-24 Special request please contact sales window
FPF05 0805	1/3W	551	1232	±1%, ±5%	±200 ±100*	50 100	91 910	
FPF06 1206	1/2W	675	1508	±1%, ±5%	±100* ±100	50 100	91 910	
FPF12 1210	1/2W	675	1508	±1%, ±5%	±100	100	910	
FPF20 2010	1W	954	2133	±1%, ±5%	±100* ±100	50 100	91 910	
FPF25 2512	2W	1349	3017	±1%, ±5%	±100* ±100	50 100	91 910	
FPF25 2512	3W	1652	3695	±1% ±5%	±100 ±200	100 100	910 910	

* Temperature 25~55°C, 200ppm for 0603, 150ppm for 0805, 1206, 2010, 2512

Note:

- (1) 2512(2W) loading with total solder-pad and trace size of 300 mm²
 - (2) 2512(3W) Solder-pad and trace size should be >300 mm² and board surface temperature should, not exceed 105°C when applying full rated power.
- (2) E = (P×R)^{1/2} E : Working Voltage(V) · P : Rated Power(W) · R : Resistance Value(Ω)

GUIDE OF CURRENT SENSING RESISTORS

Series	Product Type	Resistance Range (<1 Ω)	Power Type	AEC Q200
FMF	Metal Strip	0mΩ~220mΩ	V	V
FOF	Metal Foil	2mΩ~700mΩ	V	V
FBF	Metal Type	10mΩ~910mΩ	V	V
FPF	High Power	50mΩ~910mΩ	V	V
FCF-E	Normal	50mΩ~910mΩ		

DIMENSIONS

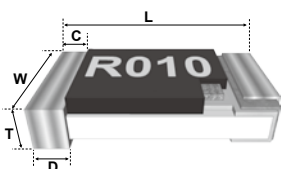

Type	L	W	C	D	T
FPF03	1.60±0.10	0.80±0.10	0.30±0.20	0.30±0.20	0.45±0.10
FPF05	2.00±0.10	1.25±0.10	0.40±0.20	0.40±0.20	0.50±0.10
FPF06	3.10±0.10	1.60±0.10	0.50±0.25	0.50±0.25	0.55±0.10
FPF12	3.10±0.10	2.60±0.10	0.50±0.25	0.50±0.25	0.55±0.10
FPF20	5.00±0.20	2.50±0.20	0.65±0.25	0.60±0.25	0.60±0.10
FPF25	6.40±0.20	3.10±0.20	0.60±0.25	1.80±0.25	0.60±0.15
FPF25 3W	6.40±0.20	3.10±0.20	0.45±0.25	1.80±0.25	1.10±0.20

POWER DE-RATING CURVE

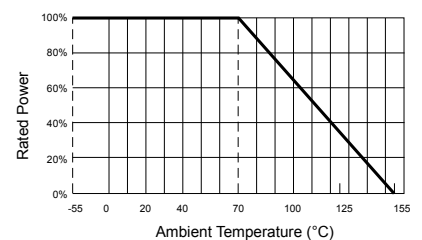

Operating Temperature Range: -55 to +155 deg.C

Thick-Film Normal Type Chip Resistors

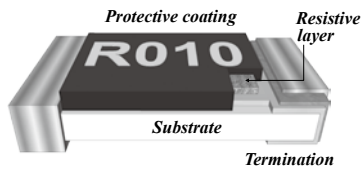

FEATURES

- Low resistance and high precision (1%).
- Excellent reliability and suitable cost.
- Suitable for lead free soldering.
- RoHS compliant & Halogen Free.

APPLICATION

- Consumer electronics, M/B.
- Battery pack, BTC.
- Notebook, Tablet PC.
- Portable Device, Electronic Equipment.

PART NUMBER

FCF	06	F	T	-	R100	-	E
Type □□□	Size □□	Tolerance □	Packing □	Watt □	R Value □□□□	TCR □	Special Code □
FCF Thick Film Normal Low ohm	03 0603 05 0805 06 1206 12 1210 20 2010 25 2512	F = ±1% J = ±5%	T =Paper tape – 5 Kpcs V =Paper tape – 10 Kpcs W =Paper tape – 20 Kpcs P =Plastic tape – 4 Kpcs X =Plastic tape – 8 Kpcs Y =Plastic tape – 16Kpcs	"-" Standard	XXXX 4 digits	"-" Standard	E: Standard Low R

RATING

Type	Normal Type Power Rating @ 70°C	Max. RCWW (mV)	Max. Overload Voltage (mV)	Resistance Tolerance (%)	Temperature Coefficient of Resistance (TCR; ppm/°C)	Resistance Range (mΩ)		Standard Resistance Values
						Min.	Max.	
FCF03 0603	1/8W	337	754	±1%, ±5%	±200 ±400	100 50	910 91	E-24
FCF05 0805	1/4W	477	1067	±1%, ±5%	±200 ±400	100 50	910 91	
FCF06 1206	1/3W	551	1232	±1%, ±5%	±200 ±400	100 50	910 91	
FCF12 1210	2/3W	779	1742	±1%, ±5%	±200 ±400	100 50	910 91	
FCF20 2010	3/4W	826	1847	±1%, ±5%	±200 ±400	100 50	910 91	
FCF25 2512	1W	954	2133	±1%, ±5%	±200 ±400	100 50	910 91	

Note :

- (1) RCWW = $(P \times R)^{1/2}$ or Max. RCWW listed above, whichever is lower.
 RCWW : Rated Continue Working Voltage(V) · P : Rated Power(W) · R : Resistance Value(Ω)
 (2) Special resistance value request please contact factory.

GUIDE OF CURRENT SENSING RESISTORS

Series	Product Type	Resistance Range (<1 Ω)	Power Type	AEC Q200
FMF	Metal Strip	0mΩ~220mΩ	V	V
FOF	Metal Foil	2mΩ~700mΩ	V	
FBF	Metal Type	10mΩ~ 910mΩ	V	
FPF	High Power	50mΩ~ 910mΩ	V	V
FCF-E	Normal	50mΩ~ 910mΩ		

DIMENSIONS

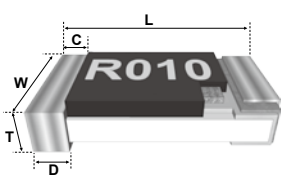

Type	L	W	C	D	T
FCF03	1.60±0.10	0.80±0.10	0.30±0.20	0.30±0.20	0.45±0.10
FCF05	2.00±0.10	1.25±0.10	0.40±0.20	0.40±0.20	0.50±0.10
FCF06	3.10±0.10	1.60±0.10	0.50±0.25	0.50±0.25	0.55±0.10
FCF12	3.10±0.10	2.60±0.10	0.50±0.25	0.50±0.25	0.55±0.10
FCF20	5.00±0.20	2.50±0.20	0.60±0.25	0.60±0.25	0.60±0.10
FCF25	6.30±0.20	3.10±0.20	0.60±0.25	0.90±0.25	0.60±0.15

POWER DE-RATING CURVE

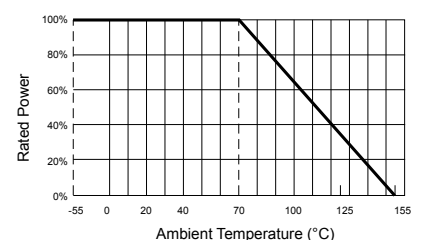

FPF

High Rated Power Thick-film Lead Free Chip Resistors

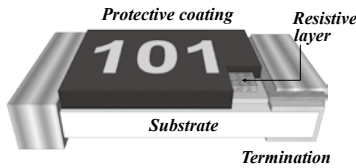

FEATURES

- High power rating to 3W and compact size.
- High reliability and high precision (1%).
- Suitable for lead free soldering.
- Meet AEC-Q200, RoHS compliant & Halogen Free.

APPLICATION

- Power supply.
- Automotive industry.
- Digital meter, Consumer electronics, M/B.
- LED Lighting.
- Industry control board.

PART NUMBER

FPF	06	J	T	G	1R0_	L	Special Code
Type □□□□	Size □□	Tolerance □	Packing □	Watt □	R Value □□□□	TCR	
FPF High Power Resistors	03 0603 05 0805 06 1206 12 1210 20 2010 25 2512	F = ±1% J = ±5%	T = Paper tape – 5 Kpcs V = Paper tape – 10 Kpcs W = Paper tape – 20 Kpcs P = Plastic tape – 4 Kpcs X = Plastic tape – 8 Kpcs Y = Plastic tape – 16Kpcs Q = Plastic tape – 3 Kpcs (For Power boost 2010 / 2512)	"-" Standard Power boost code E = 1/3W (0603) F = 1/2W(0805) G = 3/4W(1206) I = 1.5W(2010) K = 3W(2512)	XXXX >=1R 1% 4 digit 5% 3 digit ("_" means a blank)	No special code- Null Null special code- "-" Power boost code N = 100ppm Y = 150ppm L = 200ppm	"Null" Standard M: Meet AEC-Q200

RATING

Type	Normal Type Power Rating @ 70°C	Max. RCWW	Max. Overload Voltage	Resistance Tolerance (%)	Temperature Coefficient of Resistance (ppm/°C)	Resistance Range		Standard Resistance Values
						Min.	Max.	
FPF03 0603	1/8W *1/3W	50V 75V	100V 125V	±1%(F)	±100	10Ω	1MΩ	E96/E24
				±1%(F)	±200	1Ω	9.76Ω	E96/E24
				±5%(J)	±200	1Ω	1MΩ	E24
FPF05 0805	1/4W *1/2W	150V 200V	300V 300V	±1%(F)	±100	10Ω	1MΩ	E96/E24
				±1%(F)	±150	1Ω	9.76Ω	E96/E24
				±5%(J)	±200	1Ω	1MΩ	E24
FPF06 1206	1/2W *3/4W	200V 250V	400V 500V	±1%(F)	±100	1Ω	1MΩ	E96/E24
				±5%(J)	±200	1Ω	1MΩ	E24
				±1%(F)	±100	1Ω	1MΩ	E96/E24
FPF12 1210	1/2W *3/4W	200V 250V	400V 500V	±1%(F)	±100	1Ω	1MΩ	E96/E24
				±5%(J)	±200	1Ω	1MΩ	E24
				±1%(F)	±100	1Ω	1MΩ	E96/E24
FPF20 2010	1W *1.5W	200V 250V	400V 500V	±1%(F)	±100	1Ω	1MΩ	E96/E24
				±5%(J)	±200	1Ω	1MΩ	E24
				±1%(F)	±100	1Ω	1MΩ	E96/E24
FPF25 2512	2W *3W	300V	600V	±1%(F)	±100	1Ω	1MΩ	E96/E24
				±5%(J)	±200	1Ω	1MΩ	E24

Type	Description	Max. Rated Current	Resistance Range
FPF03 0603	Zero Ohm Jumper	≤ 2A	< 20mΩ
FPF05/06/12 0805-1210	Zero Ohm Jumper	≤ 4A	< 20mΩ
FPF20/25 2010-2512	Zero Ohm Jumper	≤ 6A	< 20mΩ
FPF25 3W 2512	Zero Ohm Jumper	≤ 12A	< 20mΩ

Note :

- (1) RCWW = $(P \times R)^{1/2}$ or Max. RCWW listed above, whichever is lower.
RCWW : Working Voltage (V) · P : Rated Power (W) · R : Resistance Value (Ω)
- (2) Above 2512 size, solder-pad and trace size should be >300 mm² and board surface temperature should not exceed 105°C when applying full rated power.
- (3) 2512 Solder-pad and trace size should be >300 mm² and board surface temperature should not exceed 105°C when applying full rated power.

DIMENSIONS

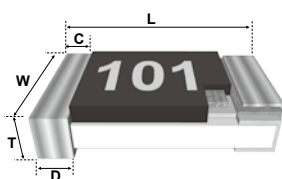

Type	L	W	C	D	T
FPF03	1.60±0.10	0.80±0.10	0.30±0.20	0.30±0.20	0.45±0.10
FPF05	2.00±0.10	1.25±0.10	0.40±0.20	0.40±0.20	0.50±0.10
FPF06	3.10±0.10	1.60±0.10	0.50±0.25	0.50±0.25	0.55±0.10
FPF12	3.10±0.10	2.60±0.10	0.50±0.25	0.50±0.25	0.55±0.10
FPF20	5.00±0.20	2.50±0.20	0.65±0.25	0.60±0.25	0.60±0.10
FPF25	6.40±0.20	3.10±0.20	0.60±0.25	1.80±0.25	0.60±0.15
FPF25 3W	6.40±0.20	3.10±0.20	0.45±0.25	1.80±0.25	1.10±0.20

POWER DE-RATING CURVE

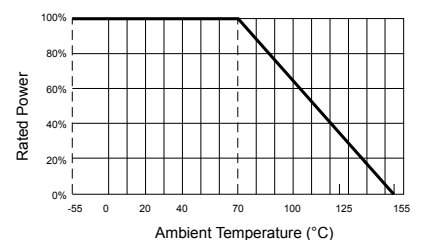

Operating Temperature Range: -55 to +155 deg.C

Thick Film High Power & Anti-Surge Chip Resistors

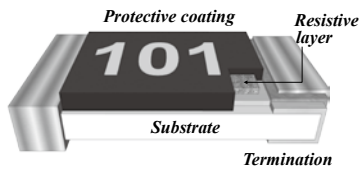

FEATURES

- High reliability and high precision (1%).
- Suitable for withstanding surge voltage.
- Suitable for lead free soldering.
- Meet AEC-Q200, RoHS compliant & Halogen Free.

APPLICATION

- Power supply.
- Automotive industry.
- Digital meter, Consumer electronics, M/B.
- LED Lighting.
- Industry control board.

PART NUMBER

FPS	08	F	T	F	1004	N	M
Type □□□	Size □□	Tolerance □	Packing □	Watt □	R Value □□□□	TCR	Special Code
FPS Thick Film High Power & Anti-Surge	03 0603 05 0805 06 1206 12 1210 20 2010 25 2512	F = ±1% J = ±5%	T = Paper tape – 5 Kpcs V = Paper tape – 10 Kpcs W = Paper tape – 20 Kpcs P = Plastic tape – 4 Kpcs X = Plastic tape – 8Kpcs Y = Plastic tape – 16Kpcs	"-" Standard E = 1/3W (0603) F = 1/2W(0805) G = 3/4W(1206)	XXXX >=1R 1% 4 digit 5% 3 digit (" " means a blank)	No special code- Null special code- "-" Power boost code N = 100ppm Y = 150ppm L = 200ppm	"Null" Standard M: Meet AEC-Q200

RATING

Type	Normal Type Power Rating @ 70°C	Max. RCWV	Max. Overload Voltage	Resistance Tolerance (%)	Temperature Coefficient of Resistance (ppm/°C)	Resistance Range		Standard Resistance Values
						Min.	Max.	
FPS03 0603	1/8W	50V	100V	±1%(F)	±100	10Ω	1MΩ	E96/E24
	*1/3W	75V	125V	±1%(F)	±200	1Ω	9.76Ω	E96/E24
				±5%(J)	±200	1Ω	1MΩ	E24
FPS05 0805	1/4W	150V	300V	±1%(F)	±100	10Ω	1MΩ	E96/E24
	*1/2W	200V	300V	±1%(F)	±150	1Ω	9.76Ω	E96/E24
				±5%(J)	±200	1Ω	1MΩ	E24
FPS06 1206	1/2W	200V	400V	±1%(F)	±100	1Ω	1MΩ	E96/E24
	*3/4W	250V	500V	±5%(J)	±200	1Ω	1MΩ	E24
				±1%(F)	±100	1Ω	1MΩ	E96/E24
FPS12 1210	1/2W	200V	400V	±1%(F)	±100	1Ω	1MΩ	E96/E24
				±5%(J)	±200	1Ω	1MΩ	E24
				±1%(F)	±100	1Ω	1MΩ	E96/E24
FPS20 2010	1W	200V	400V	±1%(F)	±100	1Ω	1MΩ	E96/E24
				±5%(J)	±200	1Ω	1MΩ	E24
				±1%(F)	±100	1Ω	1MΩ	E96/E24
FPS25 2512	2W	300V	600V	±1%(F)	±100	1Ω	1MΩ	E96/E24
				±5%(J)	±200	1Ω	1MΩ	E24
				±1%(F)	±100	1Ω	1MΩ	E96/E24

Type	Description	Max. Rated Current	Resistance Range
FPS03 0603	Zero Ohm · Jumper	≤ 2A	< 20mΩ
FPS05 0805	Zero Ohm · Jumper	≤ 4A	< 20mΩ
FPS06 1206	Zero Ohm · Jumper	≤ 4A	< 20mΩ
FPS12 1210	Zero Ohm · Jumper	≤ 4A	< 20mΩ
FPS20 2010	Zero Ohm · Jumper	≤ 6A	< 20mΩ
FPS25 2512	Zero Ohm · Jumper	≤ 6A	< 20mΩ

Note :

- (1) 2512 2W loading with total solder-pad and trace size of 300 mm²
- (2) RCWV = (P×R)^{1/2} or Max. RCWV listed above, whichever is lower. (RCWV : Rated Continue Working Voltage(V) · P : Rated Power(W) · R : Resistance Value(Ω))
- (3) Solder-pad and trace size should be evaluated and board surface temperature should not.
- (4) Exceed 105°C when applied full rated power.

DIMENSIONS

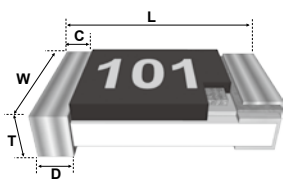

Size	L	W	C	D	T
0603	1.60±0.10	0.80±0.10	0.30±0.20	0.30±0.20	0.45±0.10
0805	2.00±0.10	1.25±0.10	0.40±0.20	0.40±0.20	0.50±0.10
1206	3.10±0.10	1.60±0.10	0.50±0.25	0.50±0.25	0.55±0.10
1210	3.10±0.10	2.60±0.10	0.50±0.25	0.50±0.25	0.55±0.10
2010	5.00±0.20	2.50±0.20	0.65±0.25	0.60±0.25	0.60±0.10
2512	6.40±0.20	3.10±0.20	0.60±0.25	1.80±0.25	0.60±0.15

POWER DE-RATING CURVE

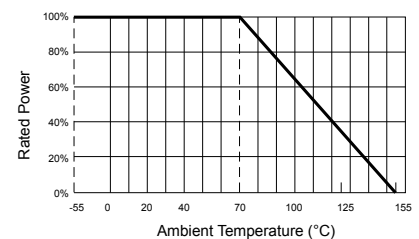

SURGE PERFORMANCE

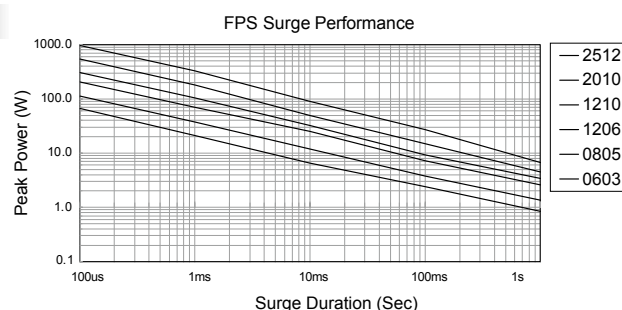

MLCC

Chip R

Coil

FNF

■ Anti-Surge Lead Free & Halogen Free Chip Resistors

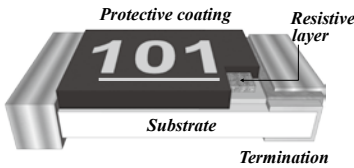

FEATURES

- High reliability and compact size.
- Suitable for withstanding surge voltage.
- Suitable for lead free soldering.
- RoHS compliant & Halogen Free.
- Meet AEC-Q200

APPLICATION

- Power supply.
- Automotive industry.
- Digital meter, Consumer electronics, M/B.
- LED Lighting.
- Industry control board.

PART NUMBER

FNF	25	J	P	-	103_	-	M
Type □□□□	Size □□	Tolerance □	Packing □	Watt □	R Value □□□□	TCR	Special Code
FNF Thick Film Anti-Surge	03 0603 05 0805 06 1206 12 1210 20 2010 25 2512	J = ± 5% K = ± 10% L = ± 15% M = ± 20%	T = Paper tape – 5 Kpcs V = Paper tape – 10 Kpcs W = Paper tape – 20 Kpcs P = Plastic tape – 4 Kpcs X = Plastic tape – 8 Kpcs Y = Plastic tape – 16Kpcs	"-" Standard	XXXX >=1R 1% 4 digit 5% 3 digit ("_" means a blank)	No special code- Null special code- "-"	"Null" Standard M: Meet AEC-Q200

RATING

Type	Normal Type Power Rating @ 70°C	Max. RCWW	Max. Overload Voltage	Resistance Tolerance (%)	Temperature Coefficient of Resistance (ppm/°C)	Resistance Range		Standard Resistance Values
						Min.	Max.	
FNF03 0603	1/10W	50V	100V					
FNF05 0805	1/8W	150V	300V	± 5%(J)				
FNF06 1206	1/4W	200V	400V	± 10%(K)	± 100	1Ω	1MΩ	E-24
FNF12 1210	1/3W	200V	400V	± 15%(L)				
FNF20 2010	3/4W	200V	400V	± 20%(M)				
FNF25 2512	1W	200V	400V					

Note :

• RCWW = (P × R)^{1/2} or Max. RCWW listed above, whichever is lower. (RCWW : Rated Continue Working Voltage(V) · P : Rated Power(W) · R : Resistance Value(Ω))

DIMENSIONS

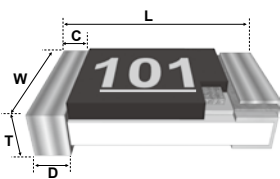

Size	unit: mm				
	L	W	C	D	T
0603	1.60 ± 0.10	0.80 ± 0.10	0.30 ± 0.20	0.30 ± 0.20	0.45 ± 0.10
0805	2.00 ± 0.10	1.25 ± 0.10	0.40 ± 0.20	0.40 ± 0.20	0.50 ± 0.10
1206	3.10 ± 0.10	1.60 ± 0.10	0.50 ± 0.25	0.50 ± 0.25	0.55 ± 0.10
1210	3.10 ± 0.10	2.60 ± 0.10	0.50 ± 0.25	0.50 ± 0.25	0.55 ± 0.10
2010	5.00 ± 0.20	2.50 ± 0.20	0.60 ± 0.25	0.60 ± 0.25	0.60 ± 0.10
2512	6.40 ± 0.20	3.20 ± 0.20	0.60 ± 0.25	0.90 ± 0.25	0.60 ± 0.15

POWER DE-RATING CURVE

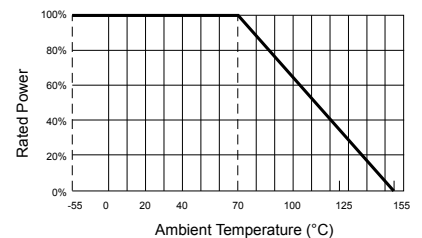

MARKING/SOLDERING

Resistance value identify

E24 ± 5% : 3 Digits marking with underline to identify the resistance value

0603/0805/1206/1210/2010/2512

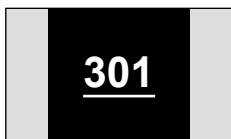

301 → 30 × 10¹ = 300Ω

SURGE PERFORMANCE

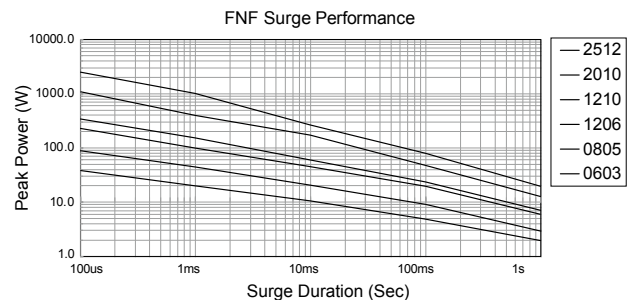

High Ohmic Lead Free Chip Resistors

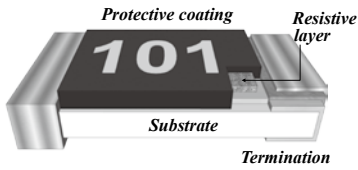

FEATURES

- Small size and light weight with size range per int'l standard.
- Highly stable in auto-placement surface mounting application.
- Compatible with flow and reflow soldering.
- RoHS compliant & Halogen Free.

APPLICATION

- Medical equipment.
- Printer.
- Automotive industry.
- Converter.
- Power supply in small size.

PART NUMBER

FHF	12	J	T	-	104_	TCR	Special Code
Type □□□	Size □□	Tolerance □	Packing □	Watt □	R Value □□□□		
FHF Thick Film High Ohmic	02 0402 03 0603 05 0805 06 1206	F = ±1% J = ±5%	T = Paper tape – 5 Kpcs V = Paper tape – 10 Kpcs W = Paper tape – 20 Kpcs	"-" Standard	XXXX >=1R 1% 4 digit 5% 3 digit ("_" means a blank)	No special code- Null special code- "-"	"Null" Standard

RATING

Type	Normal Type Power Rating @ 70°C	Max. RCWW	Max. Overload Voltage	Resistance Tolerance (%)	Temperature Coefficient of Resistance (TCR; ppm/°C)	Resistance Range		Standard Resistance Values
						Min.	Max.	
FHF02 0402	1/16W	50V	100V	±1%(F) ±5%(J)	±300	11MΩ	30MΩ	E-24
FHF03 0603	1/10W	50V	100V	±1%(F) ±5%(J)	±200	11MΩ	22MΩ	
FHF05 0805	1/8W	150V	300V	±1%(F) ±5%(J)	±200	11MΩ	22MΩ	E-12
FHF06 1206	1/4W	200V	400V	±1%(F) ±5%(J)	±200	11MΩ	22MΩ	

Note:
(1) RCWW = $(P \times R)^{1/2}$ or Max. RCWW listed above, whichever is lower.
RCWW : Rated Continue Working Voltage(V) · P : Rated Power(W) · R : Resistance Value(Ω)

DIMENSIONS

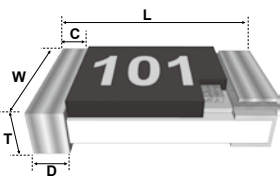

Type 1	L	W	C	D	T	unit: mm
FHF02	1.00 ± 0.05	0.50 ± 0.05	0.20 ± 0.10	0.25 ± 0.10	0.35 ± 0.05	
FHF03	1.60 ± 0.10	0.80 ± 0.10	0.30 ± 0.20	0.30 ± 0.20	0.45 ± 0.10	
FHF05	2.00 ± 0.10	1.25 ± 0.10	0.40 ± 0.20	0.40 ± 0.20	0.50 ± 0.10	
FHF06	3.10 ± 0.10	1.60 ± 0.10	0.50 ± 0.20	0.50 ± 0.25	0.55 ± 0.10	

POWER DE-RATING CURVE

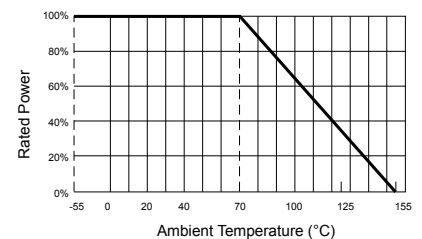

MARKING/SOLDERING

Each resistor is marked with a three digits code on the protective coating to designate the nominal resistance value.

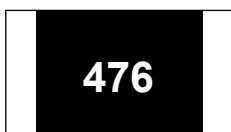

3 digit marking for ±1% ±5%
examples :
306 = 30MΩ
476 = 47MΩ

FGF

■ Non-Magnetic Lead Free Chip Resistors

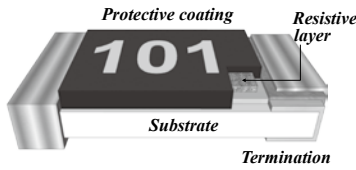

FEATURES

- Non-Magnetic chip resistors by copper plating on middle termination.
- Non-Magnetic chip resistors pass 3000 gauss magnetic detection.
- Compatible with flow and reflow soldering.
- Suitable for lead free soldering.
- Meet RoHS compliant.
- RoHS compliant & Halogen Free.

APPLICATION

- Medical equipment.
- Automotive industry.
- MRI industry.
- Measurement instrument.

PART NUMBER

FGF	05	F	T	-	1002	TCR	Special Code
Type □□□□	Size □□	Tolerance □	Packing □	Watt □	R Value □□□□		
FGF Thick Film Non-Magnetic	03 0603 05 0805 06 1206	F = ±1% J = ±5%	T = Paper tape – 5 Kpcs V = Paper tape – 10 Kpcs W = Paper tape – 20 Kpcs	"-" Standard	XXXX >=1R 1% 4 digit 5% 3 digit ("_" means a blank)	No special code- Null special code- "-"	"Null" Standard

RATING

Type	Normal Type Power Rating @ 70°C	Max. RCWW	Max. Overload Voltage	Resistance Tolerance (%)	Temperature Coefficient of Resistance (TCR; ppm/°C)	Resistance Range		Standard Resistance Values
						Min.	Max.	
FGF03 0603	1/10W	50V	100V	±1%(F) ±5%(J)	±100 ±200	1Ω 10MΩ	10MΩ	E-96 E-24
FGF05 0805	1/8W	150V	300V	±1%(F) ±5%(J)	±100 ±200	1Ω 10MΩ	10MΩ	E-96 E-24
FGF06 1206	1/4W	200V	400V	±1%(F) ±5%(J)	±100 ±200	1Ω 10MΩ	10MΩ	E-96 E-24

Jumper :

- 0603 size maximum resistance $R_{max} < 50m\Omega$ and rated current $I_R \leq 1A$
- 0805, 1206 size maximum resistance $R_{max} < 50m\Omega$ and rated current $I_R \leq 2A$

Note :

- (1) $RCWW = (P \times R)^{1/2}$ or Max. RCWW listed above, whichever is lower.
RCWW : Rated Continue Working Voltage(V) · P : Rated Power(W) · R : Resistance Value(Ω)
- (2) 1Ω~10Ω: Temperature Coefficient of Resistance for 0603, 0805, 1206 = -300 ~ +500

DIMENSIONS

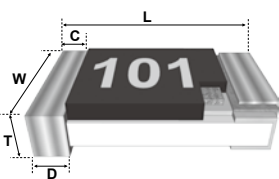

Type	L	W	C	D	T
FGF03	1.60±0.10	0.80±0.10	0.30±0.20	0.30±0.20	0.45±0.10
FGF05	2.00±0.10	1.25±0.10	0.40±0.20	0.40±0.20	0.50±0.10
FGF06	3.10±0.10	1.60±0.10	0.50±0.20	0.50±0.25	0.55±0.10

unit: mm

POWER DE-RATING CURVE

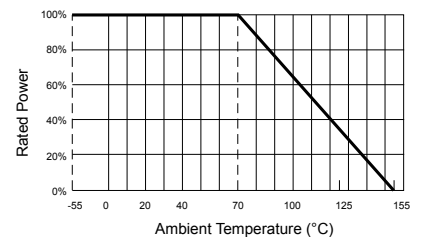

■ Safety Certified Thick-Film Type High-Voltage Lead Free Chip Resistors

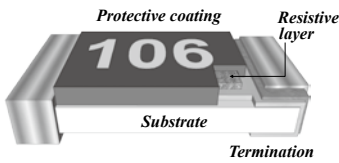

FEATURES

- Special materials and design for higher working voltage required.
- Compatible with flow and reflow soldering.
- Suitable for lead free soldering.
- Voltage coefficient resistance 100ppm, Max. below 300ppm.
- Meet AEC-Q200, RoHS compliant & Halogen Free.
- Safety resistor certificate meet
 - ... UL/IEC 62368 Resistors requirements certificated.
 - ... UL/IEC 60950-1 certificated.
 - ... UL/IEC 60065., UL1676 qualified.

APPLICATION

- Power supply.
- Automotive industry.
- Measurement instrument.
- Medical equipment.



PART NUMBER

FVS	25	F	P	-	1004	-	M
Type □□□	Size □□	Tolerance □	Packing □	Watt □	R Value □□□□	TCR	Special Code
FVS Thick Film High Voltage UL Safety Certification	03 0603 05 0805 06 1206 20 2010 25 2512	F = ± 1% J = ± 5%	T = Paper tape – 5 Kpcs V = Paper tape – 10 Kpcs W = Paper tape – 20 Kpcs P = Plastic tape – 4 Kpcs X = Plastic tape – 8Kpcs Y = Plastic tape – 16Kpcs	"-" Standard	XXXX >=1R 1% 4 digit 5% 3 digit ("_" means a blank)	No special code- Null special code- "-"	"Null" Standard M: Meet AEC-Q200

RATING

Type	Normal Type Power Rating @ 70°C	Max. RCWW	Max. Overload Voltage	Resistance Tolerance (%)	Temperature Coefficient of Resistance (ppm/°C)	Resistance Range		Standard Resistance Values
						Min.	Max.	
FVS03 0603	1/10W	200V	400V	± 1%(F)	± 100	100KΩ	10MΩ	E96/E24
				± 5%(J)	± 200	100KΩ	22MΩ	E24
FVS05 0805	1/8W	400V	800V	± 1%(F)	± 100	100KΩ	10MΩ	E96/E24
				± 5%(J)	± 200	100KΩ	22MΩ	E24
FVS06 1206	1/4W	800V	1600V	± 1%(F)	± 100	100KΩ	10MΩ	E96/E24
				± 5%(J)	± 200	11MΩ	22MΩ	E24
FVS20 2010	1/2W	2000V	3000V	± 1%(F)	± 100	100KΩ	10MΩ	E96/E24
				± 5%(J)	± 200	100KΩ	100MΩ	E24
FVS25 2512	1W	3000V	4000V	± 1%(F)	± 100	100KΩ	10MΩ	E96/E24
				± 5%(J)	± 200	100KΩ	100MΩ	E24

Note :
 (1) RCWW = (P × R)^{1/2} or Max. RCWW listed above, whichever is lower.
 RCWW : Rated Continue Working Voltage(V) · P : Rated Power(W) · R : Resistance Value(Ω)

DIMENSIONS

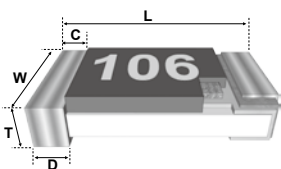

Type	L	W	C	D	T
FVS03	1.60 ± 0.10	0.80 ± 0.10	0.30 ± 0.20	0.30 ± 0.20	0.45 ± 0.10
FVS05	2.00 ± 0.10	1.25 ± 0.10	0.35 ± 0.20	0.40 ± 0.20	0.50 ± 0.10
FVS06	3.10 ± 0.10	1.60 ± 0.10	0.45 ± 0.20	0.50 ± 0.20	0.55 ± 0.10
FVS20	5.00 ± 0.20	2.50 ± 0.20	0.60 ± 0.25	0.60 ± 0.25	0.60 ± 0.10
FVS25	6.40 ± 0.20	3.20 ± 0.20	0.60 ± 0.25	0.90 ± 0.25	0.60 ± 0.15

unit: mm

Resistance value identify :
 Top side color is "Red" for identify high voltage product.

POWER DE-RATING CURVE

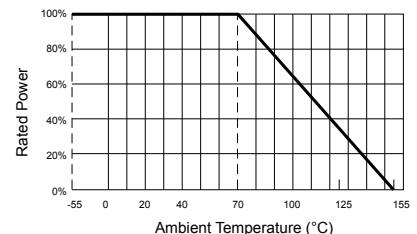

Operating Temperature Range: -55 to +155 deg.C

MLCC

Chip R

Coil

FVF

Thick-Film Type High-Voltage Lead Free Chip Resistors

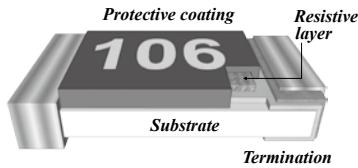

FEATURES

- Special materials and design for higher working voltage required.
- Compatible with flow and reflow soldering.
- Suitable for lead free soldering.
- Max. Voltage coefficient resistance below 300ppm.
- Meet AEC-Q200, RoHS compliant & Halogen Free.

APPLICATION

- Power supply.
- Automotive industry.
- Measurement instrument.
- Medical equipment.

PART NUMBER

FVF	25	F	P	-	1004	-	M
Type	Size	Tolerance	Packing	Watt	R Value	TCR	Special Code
□□□	□□	□	□	□	□□□□		
FVF Thick Film High Voltage	03 0603 05 0805 06 1206 20 2010 25 2512	F = ±1% J = ±5%	T = Paper tape – 5 Kpcs V = Paper tape – 10 Kpcs W = Paper tape – 20 Kpcs P = Plastic tape – 4 Kpcs X = Plastic tape – 8Kpcs Y = Plastic tape – 16Kpcs	"-" Standard	XXXX >=1R 1% 4 digit 5% 3 digit ("_" means a blank)	No special code- Null special code- "-"	"Null" Standard M: Meet AEC-Q200

RATING

Type	Normal Type Power Rating @ 70°C	Max. RCWW	Max. Overload Voltage	Resistance Tolerance (%)	Temperature Coefficient of Resistance (ppm/°C)	Resistance Range		Standard Resistance Values
						Min.	Max.	
FVF03 0603	1/10W	200V	400V	±1%(F)	±100	100KΩ	10MΩ	E96/E24
				±5%(J)	±200	100KΩ	22MΩ	E24
FVF05 0805	1/8W	400V	800V	±1%(F)	±100	100KΩ	10MΩ	E96/E24
				±5%(J)	±200	100KΩ	22MΩ	E24
FVF06 1206	1/4W	800V	1600V	±1%(F)	±100	100KΩ	10MΩ	E96/E24
				±5%(J)	±200	100KΩ	100MΩ	E24
FVF20 2010	1/2W	2000V	3000V	±1%(F)	±100	100KΩ	10MΩ	E96/E24
				±5%(J)	±200	100KΩ	100MΩ	E24
FVF25 2512	1W	3000V	4000V	±1%(F)	±100	100KΩ	10MΩ	E96/E24
				±5%(J)	±200	100KΩ	100MΩ	E24

Note :

(1) RCWW = (P × R)^{1/2} or Max. RCWW listed above, whichever is lower.
RCWW : Rated Continue Working Voltage(V) • P : Rated Power(W) • R : Resistance Value(Ω)

DIMENSIONS

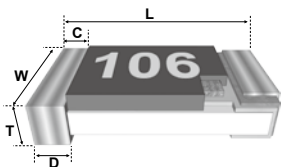

Type	L	W	C	D	T
FVF03	1.60 ± 0.10	0.80 ± 0.10	0.30 ± 0.20	0.30 ± 0.20	0.45 ± 0.10
FVF05	2.00 ± 0.10	1.25 ± 0.10	0.40 ± 0.20	0.40 ± 0.20	0.50 ± 0.10
FVF06	3.10 ± 0.10	1.60 ± 0.10	0.50 ± 0.20	0.50 ± 0.20	0.55 ± 0.10
FVF20	5.00 ± 0.20	2.50 ± 0.20	0.65 ± 0.25	0.60 ± 0.25	0.60 ± 0.10
FVF25	6.40 ± 0.20	3.20 ± 0.20	0.65 ± 0.25	0.90 ± 0.25	0.60 ± 0.15

unit: mm

POWER DE-RATING CURVE

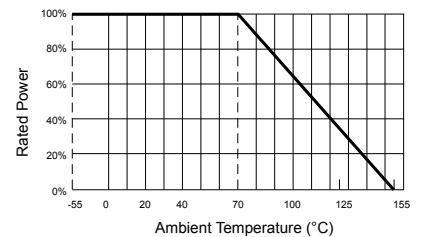

Thick Film Lead Free Chip Resistors

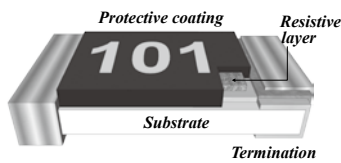

FEATURES

- Meet AEC-Q200 test for Automotive industry.
- Suitable for lead free soldering.
- Compatible with wave and reflow soldering.
- Anti-sulfurate products.
- RoHS compliant & Halogen Free.

APPLICATION

- Automotive industry.
- Digital meter, Consumer electronics, M/B.
- Portable electronic devices

PART NUMBER

FWF	03	F	T	-	1004	-	W
Type	Size	Tolerance	Packing	Watt	R Value	TCR	Special Code
□□□	□□	□	□	□	□□□□		
FWF Thick Film Automotive	02 0402 03 0603 05 0805 06 1206 12 1210 20 2010 25 2512	F = ±1% J = ±5%	T = Paper tape – 5 Kpcs V = Paper tape – 10 Kpcs W = Paper tape – 20 Kpcs P = Plastic tape – 4 Kpcs X = Plastic tape – 8Kpcs Y = Plastic tape – 16Kpcs	"-" Standard	XXXX >=1R 1% 4 digit 5% 3 digit ("_" means a blank)	No special code- Null special code- "-"	"Null" Standard W: Anti-sulfur H2S 1000ppm S: Safety concern application

RATING

Type	Normal Type Power Rating @ 70°C	Max. RCWV	Max. Overload Voltage	Resistance Tolerance (%)	Temperature Coefficient of Resistance (TCR ; ppm/°C)	Resistance Range		Standard Resistance Values
						Min.	Max.	
FWF02 0402	1/16W	50V	100V	±1(F) ±5(J)	±200	> 1MΩ	10MΩ	±1%(F) : E-96/E-24 ±5%(J) : E-24
					±100	> 10Ω	1MΩ	
					-200~+400	0 & 1Ω	10Ω	
FWF03 0603	1/10W	75V	150V	±1(F) ±5(J)	±200	> 1MΩ	10MΩ	
					±100	> 10Ω	1MΩ	
					-200~+400	0 & 1Ω	10Ω	
FWF05 0805	1/8W	150V	300V	±1(F) ±5(J)	±200	> 1MΩ	10MΩ	
					±100	> 10Ω	1MΩ	
					-200~+400	0 & 1Ω	10Ω	
FWF06 1206	1/4W	200V	400V	±1(F) ±5(J)	±200	> 1MΩ	10MΩ	
					±100	> 10Ω	1MΩ	
					-200~+400	0 & 1Ω	10Ω	
FWF12 1210	1/2W	200V	400V	±1(F) ±5(J)	±200	> 1MΩ	10MΩ	
					±100	> 10Ω	1MΩ	
					-200~+400	0 & 1Ω	10Ω	
FWF20 2010	1/2W	200V	400V	±1(F) ±5(J)	±200	> 1MΩ	10MΩ	
					±100	> 10Ω	1MΩ	
					±200	0 & 1Ω	10Ω	
FWF25 2512	1W	250V	500V	±1(F) ±5(J)	±200	> 1MΩ	10MΩ	
					±100	> 10Ω	1MΩ	
					±200	0 & 1Ω	10Ω	

Type	Description	Max. Rated Current	Resistance Range
FWF02 0402	Zero Ohm · Jumper	≦ 1A	< 50mΩ
FWF03 0603	Zero Ohm · Jumper	≦ 1A	< 50mΩ
FWF05 0805	Zero Ohm · Jumper	≦ 2A	< 50mΩ
FWF06 1206	Zero Ohm · Jumper	≦ 2A	< 50mΩ
FWF12 1210	Zero Ohm · Jumper	≦ 3A	< 50mΩ
FWF20 2010	Zero Ohm · Jumper	≦ 3A	< 50mΩ
FWF25 2512	Zero Ohm · Jumper	≦ 3A	< 50mΩ

Note :
 (1) RCWV = (P × R)^{1/2} or Max. RCWV listed above, whichever is lower.
 RCWV : Rated Continue Working Voltage(V) · P : Rated Power(W) · R : Resistance Value(Ω)

DIMENSIONS

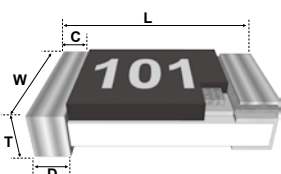

Size	L	W	C	D	T
0402	1.00±0.05	0.50±0.05	0.20±0.10	0.25±0.10	0.35±0.05
0603	1.60±0.10	0.80±0.10	0.30±0.20	0.30±0.20	0.45±0.10
0805	2.00±0.10	1.25±0.10	0.40±0.20	0.40±0.20	0.50±0.10
1206	3.10±0.10	1.60±0.10	0.50±0.25	0.50±0.25	0.55±0.10
1210	3.10±0.10	2.60±0.10	0.50±0.25	0.50±0.25	0.55±0.10
2010	5.00±0.20	2.50±0.20	0.60±0.25	0.60±0.25	0.60±0.10
2512	6.40±0.20	3.20±0.20	0.60±0.25	0.90±0.25	0.60±0.15

POWER DE-RATING CURVE

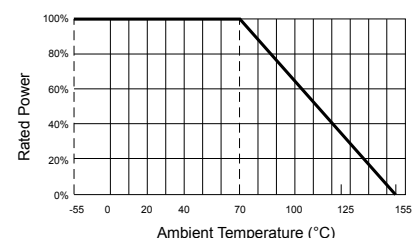

Operating Temperature Range: -55 to +155 deg.C

MLCC

Chip R

Coil

FCF

Thick Film Lead Free Chip Resistors

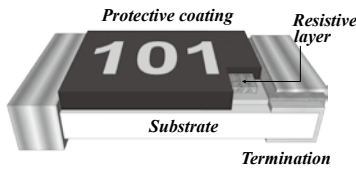

FEATURES

- Suitable for lead free soldering.
- Compatible with wave and reflow soldering.
- RoHS compliant & Halogen free.

APPLICATION

- Portable Devices.
- Measurement instrument.
- Consumer Electronics.
- Computers /Motherboard.

PART NUMBER

FCF	05	F	T	-	1002	P	Special Code
Type □□□	Size □□	Tolerance □	Packing □	Watt □	R Value □□□□	TCR	
FCF Thick Film Normal	0A 01005 01 0201 02 0402 03 0603 05 0805 06 1206 12 1210 20 2010 25 2512	B = ±0.1% C = ±0.25% D = ±0.5% F = ±1% G = ±2% J = ±5%	T =Paper tape – 5 Kpcs V =Paper tape – 10 Kpcs U =Paper tape – 15Kpcs W =Paper tape – 20 Kpcs P =Plastic tape – 4 Kpcs X =Plastic tape – 8Kpcs Y =Plastic tape – 16Kpcs	"-" Standard	XXXX >=1R 1% 4 digit 5% 3 digit ("_" means a blank)	No special code- Null special code- "-" for Special TCR Q =25ppm P =50 ppm	"Null" Standard

RATING

Type	Power Rating at 70°C	Max. RCWW	Max. Overload Voltage	Resistance Toleranc (%)	Temperature Coefficient (TCR; ppm/°C)	Resistance Range (Ω)		Standard Resistance Values
						Min.	Max.	
FCF0A 01005	1/32W	15V	30V	±1%(F)	±200	100	1M	
				±5%(J)	±300	10	91	
FCF01 0201	1/20W	25V	50V	±1%(F)	±200	10	10M	
				±5%(J)	-200 ~ +600	0 & 1	9.76	
FCF02 0402	1/16W	50V	100V	±0.1%(B)	±100	10	1M	
				±0.5%(D)	±100	10.2	10M	
				±1%(F)	-200 ~ +400	1	10	
				±5%(J)	±200	10.2	10M	
FCF03 0603	1/10W	75V	100V	±0.1%(B)	±100	10	1M	
				±0.5%(D)	±100	10.2	10M	
				±1%(F)	-200 ~ +400	1	10	
				±5%(J)	±200	10.2	10M	
FCF05 0805	1/8W	150V	300V	±0.1%(B)	±100	10	1M	±0.1%(B) : E-96/E-24 ±0.5%(D) : E-96/E-24 ±1%(F) : E-96/E-24 ±5%(J) : E-24/Jumper
				±0.5%(D)	±100	10.2	10M	
				±1%(F)	-200 ~ +400	1	10	
				±5%(J)	±200	10.2	10M	
FCF06 1206	1/4W	200V	400V	±0.1%(B)	±100	10	1M	
				±0.5%(D)	±100	10.2	10M	
				±1%(F)	-200 ~ +400	1	10	
				±5%(J)	±200	10.2	10M	
FCF12 1210	1/3W	200V	400V	±0.1%(B)	±100	10.2	10M	
				±0.5%(D)	±100	10.2	10M	
				±1%(F)	±200	1	10	
				±5%(J)	±200	0 & 1	10M	
FCF20 2010	3/4W	200V	400V	±0.1%(B)	±100	10.2	10M	
				±0.5%(D)	±100	10.2	10M	
				±1%(F)	±200	1	10	
				±5%(J)	±200	0 & 1	10M	
FCF25 2512	1W	250V	500V	±0.1%(B)	±100	10.2	10M	
				±0.5%(D)	±100	10.2	10M	
				±1%(F)	±200	1	10	
				±5%(J)	±200	0 & 1	10M	

Jumper :

- 01005 size maximum resistance $R_{max} < 50m$ and rated current $I_R \leq 0.8A$
- 0201, 0402, 0603 size maximum resistance $R_{max} < 50m$ and rated current $I_R \leq 1A$
- 0805, 1206, 1210, 2010, 2512 size maximum resistance $R_{max} < 50m$ and rated current $I_R \leq 2A$

Note :

(1) RCWW = $(P \times R)^{1/2}$ or Max. RCWW listed above, whichever is lower.

RCWW : Rated Continue Working Voltage(V) · P : Rated Power(W) · R : Resistance Value(Ω)

Thick Film Lead Free Chip Resistors

RATING

Special TCR High Precision Type

Type	Normal Type Power Rating @ 70°C	Max. RCWW	Max. Overload Voltage	Resistance Tolerance (%)	Temperature Coefficient of Resistance (ppm/°C)	Resistance Range		Standard Resistance Values
						Min.	Max.	
FCF02 0402	1/16W	50V	100V	±0.1%(B) ±0.25%(C) ±0.5%(D)	±50	100	1M	E-96
FCF03 0603	1/10W	50V	100V		±25	470	470K	E-96
FCF05 0805	1/8W	150V	300V	±25	±50	470	470K	E-96
FCF06 1206	1/4W	200V	400V	±25	±50	470	470K	E-96
				±25	±50	20	510K	E-96

Note:
 (1) RCWW = $(P \times R^{1/2})$ or Max. RCWW listed above, whichever is lower.
 RCWW : Rated Continue Working Voltage(V) · P : Rated Power(W) · R : Resistance Value(Ω)

DIMENSIONS

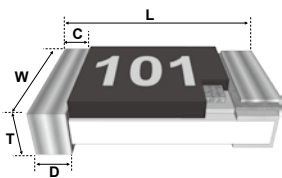

unit: mm

Size	L	W	C	D	T
01005	0.40±0.02	0.20±0.02	0.08±0.03	0.10±0.03	0.13±0.02
0201	0.60±0.03	0.30±0.03	0.10±0.05	0.15±0.05	0.23±0.03
0402	1.00±0.05	0.50±0.05	0.20±0.10	0.25±0.10	0.35±0.05
0603	1.60±0.10	0.80±0.10	0.30±0.20	0.30±0.20	0.45±0.10
0805	2.00±0.10	1.25±0.10	0.40±0.20	0.40±0.20	0.50±0.10
1206	3.10±0.10	1.60±0.10	0.50±0.20	0.50±0.25	0.55±0.10
1210	3.10±0.10	2.60±0.15	0.50±0.25	0.50±0.25	0.55±0.10
2010	5.00±0.20	2.50±0.20	0.60±0.25	0.60±0.25	0.60±0.10
2512	6.40±0.20	3.20±0.20	0.60±0.25	0.90±0.25	0.60±0.15

POWER DE-RATING CURVE

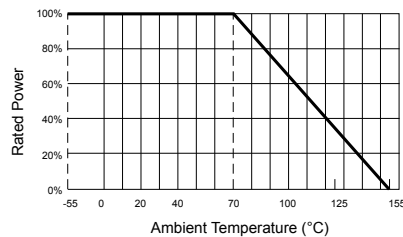

Maximum dissipation in percentage of rated power as a function of the ambient temperature for 0402, 0603, 0805, 1206, 1210, 2010, 2512

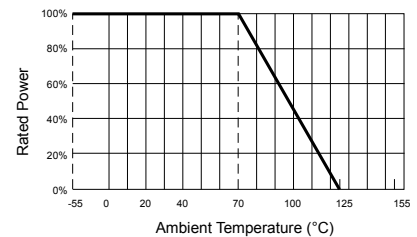

Maximum dissipation in percentage of rated power as a function of the ambient temperature for 0201, 01005

FCF ARRAY

Thick Film Lead Free Chip Resistor Networks

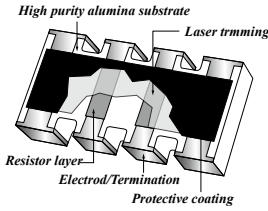

Fig 1. Construction of a Chip-R array (convex type)

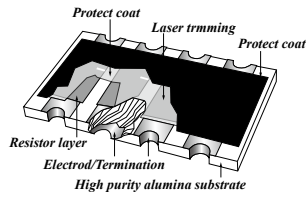

Fig 2. Construction of a Chip-R array (concave type)

FEATURES

- High density packaging provides higher productivity.
- Stable convex terminal reduces assembly costs.
- Compatible with flow and reflow soldering.
- RoHS compliant & Halogen Free.

APPLICATION

- Computer.
- Mobile phone.
- Camcorder.
- Portable audio.
- Battery charger.
- Hard Disk Driver.

PART NUMBER

FCF Type □□□□	340 Size □□	J Tolerance □	T Packing □	- Watt □	473 R Value □□□□	TCR	Special Code
FCF Thick Film Array	240 0402x4 (8P4R Convex) 340 0603x4 (8P4R Convex) 220 0402x2 (4P2R Convex) 320 0603x2 (4P2R Convex) 370 0602x8 (16P8R Convex) 241 0402x4 (8P4R Concave) 341 0603x4 (8P4R Concave) 35R 0402x8 (10P8R Convex)	F = ± 1% J = ± 5%	Paper tape T = 5Kpcs V = 10Kpcs W = 20Kpcs	"-" Standard	XXXX >=1R 1% 4 digit 5% 3 digit ("-" means a blank)	No special code-Null special code- "-"	"Null" Standard

RATING

Type	Termination Construction	Normal Type Power Rating @ 70°C	Max. RCWV	Max. Overload Voltage	Resistance Tolerance (%)	Temperature Coefficient of Resistance (TCR; ppm/°C)	Resistance Range		Standard Resistance Values
							Min.	Max.	
FCF220 4P2R/0402x2	Convex	1/16W	25V	50V	± 5%(J)	± 300 ± 400	0Ω, 10Ω 3Ω	1MΩ 9.1Ω	
FCF320 4P2R/0603x2	Convex	1/10W	50V	100V	± 5%(J) ± 1%(F)	± 200 -300~+500	0Ω, 10Ω 1Ω	1MΩ 9.1Ω	
FCF240 8P4R/0402x4	Convex	1/16W	50V	100V	± 5%(J) ± 1%(F)	± 200 -300~+500	0Ω, 10Ω 3Ω	1MΩ 9.1Ω	
FCF340 8P4R/0603x4	Convex	1/10W	50V	100V	± 5%(J) ± 1%(F)	± 200 -300~+500	0Ω, 10Ω 1Ω	1MΩ 9.1Ω	E-24
FCF241 8P4R/0402x4	Concave	1/16W	25V	50V	± 5%(J) ± 1%(F)	± 300	0Ω, 3Ω	1MΩ	
FCF341 8P4R/0603x4	Concave	1/10W	50V	100V	± 5%(J) ± 1%(F)	± 200	0Ω, 10Ω	1MΩ	
FCF35R 10P8R/0402x8	Convex	1/16W	25V	50V	± 5%(J)	± 200	10Ω	100KΩ	
FCF370 10P8R/0602x8	Convex	1/16W	50V	100V	± 5%(J) ± 1%(F)	± 200	0Ω, 10Ω	100KΩ	

Jumper :

- Maximum resistance Rmax < 50mΩ.

Note :

- (1) RCWV = (P × R)^{1/2} or Max. RCWV listed above, whichever is lower.
RCWV : Rated Continue Working Voltage(V) · P : Rated Power(W) · R : Resistance Value(Ω)

DIMENSIONS

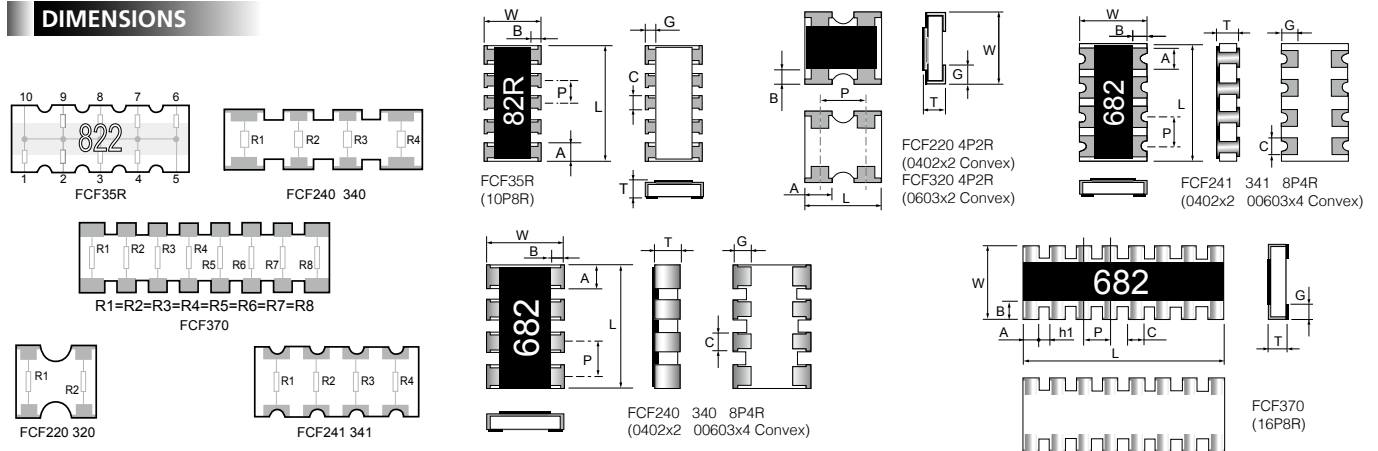

unit: mm

Type	L	W	T	B	G	P	C	A	h1
FCF220	1.00±0.10	1.00±0.10	0.35±0.10	0.20±0.15	0.25±0.17	0.65±0.10	-	0.34±0.10	-
FCF240	2.00±0.10	1.00±0.10	0.45±0.10	0.20±0.10	0.25±0.10	0.50±0.05	0.30±0.05	0.40±0.10	-
FCF241	2.00±0.10	1.00±0.10	0.45±0.10	0.20±0.15	0.25±0.10	0.50±0.05	0.25±0.05	0.25±0.05	-
FCF320	1.60±0.20	1.50±0.10	0.50±0.10	0.30±0.15	0.30±0.15	1.00±0.10	-	0.60±0.10	-
FCF340	3.20±0.20	1.60±0.10	0.50±0.10	0.30±0.20	0.30±0.20	0.80±0.10	0.45±0.10	0.60±0.15	-
FCF341	3.20+0.20/-0.10	1.60+0.20/-0.10	0.60±0.10	0.35±0.15	0.50±0.15	0.80±0.10	0.50±0.15	0.60±0.15	-
FCF35R	3.30±0.20	1.60±0.15	0.55±0.10	0.40±0.15	0.40±0.15	0.64±0.05	0.40±0.15	0.50±0.05	-
FCF370	4.00±0.20	1.60±0.15	0.45±0.10	0.30±0.25	0.30±0.20	0.50±0.20	0.30±0.10	0.40±0.20	0.20±0.10

MLCC

Chip R

Coil

■ RoHS Exemption Free (Pb≤100ppm) Thick-film Lead Free Chip Resistors

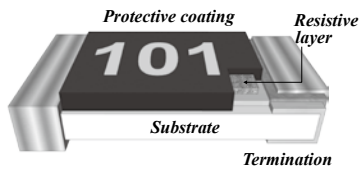

FEATURES

- Small size and light weight.
- Suitable for lead free soldering.
- Compatible with wave and reflow soldering.
- RoHS compliant & Halogen free.
- Lead content below 100ppm.

APPLICATION

- Mobile phon.
- Digital meter, Consumer electronics, M/B.
- Portable electronics devices.

PART NUMBER

FCF	05	F	T	-	1001	-	G
Type □□□	Size □□	Tolerance □	Packing □	Watt □	R Value □□□□	TCR □	Special Code □
FCF Thick Film RoHS Exemption Free	02 0402 03 0603 05 0805 06 1206 12 1210 18 1218 20 2010 25 2512	F = ±1% J = ±5%	Paper tape T = 5Kpcs V = 10Kpcs W = 20Kpcs Plastic tape P = 4Kpcs Q = 3Kpcs (For 1218)	"-" Standard	XXXX >=1R 1% 4 digit 5% 3 digit ("-" means a blank)	No special code- Null special code- "-"	G: Green series

RATING

Type	Normal Type Power Rating @ 70°C	Max. RCWV	Max. Overload Voltage	Resistance Tolerance (%)	Temperature Coefficient of Resistance (TCR; ppm/°C)	Resistance Range		Standard Resistance Values	
						Min.	Max.		
FCF02 0402	1/16W	50V	100V	±1%(F)	-300/+500	1 Ω	10 Ω	E24 E96	
					±100	10.2 Ω	976 KΩ		
					±300	1 MΩ	10 MΩ		
					-300/+500	1 Ω	10 Ω		
					±5%(J)	±200	11 Ω		910 KΩ
					±300	1 MΩ	10 MΩ		
FCF03 0603	1/10W	50V	100V	±1%(F)	-300/+500	1 Ω	10 Ω	E24 E96	
					±100	10.2 Ω	976 KΩ		
					±200	1 MΩ	10 MΩ		
					-300/+500	1 Ω	10 Ω		
					±5%(J)	±200	11 Ω		910 KΩ
					±200	1 MΩ	10 MΩ		
FCF05 0805	1/8W	150V	300V	±1%(F)	-300/+500	1 Ω	10 Ω	E24 E96	
					±100	10.2 Ω	976 KΩ		
					±200	1 MΩ	10 MΩ		
					-300/+500	1 Ω	10 Ω		
					±5%(J)	±200	11 Ω		910 KΩ
					±200	1 MΩ	10 MΩ		
FCF06 1206	1/4W	200V	400V	±1%(F)	-300/+500	1 Ω	10 Ω	E24 E96	
					±100	10.2 Ω	976 KΩ		
					±200	1 MΩ	10 MΩ		
					-300/+500	1 Ω	10 Ω		
					±5%(J)	±200	11 Ω		910 KΩ
					±200	1 MΩ	10 MΩ		

FCF-G

■ RoHS Exemption Free (Pb≤100ppm) Thick-film Lead Free Chip Resistors

RATING

Type	Normal Type Power Rating @ 70°C	Max. RCWW	Max. Overload Voltage	Resistance Tolerance (%)	Temperature Coefficient of Resistance (TCR ; ppm/°C)	Resistance Range		Standard Resistance Values
						Min.	Max.	
FCF12 1210	1/3W	200V	400V	±1%(F)	-300/+500	1 Ω	10 Ω	E24 E96
					±100	10.2 Ω	976 KΩ	
					±200	1 MΩ	10 MΩ	
FCF20 2010	1/2W	200V	400V	±5%(J)	-300/+500	1 Ω	10 Ω	E24 Jumper
					±200	11 Ω	910 KΩ	
					±200	1 MΩ	10 MΩ	
FCF25 2512	1W	250V	500V	±1%(F)	±100	1 Ω	10 Ω	E24 E96
					±200	10.2 Ω	10 MΩ	
					±200	1 Ω	10 Ω	
FCF18 1218	1W	200V	400V	±5%(J)	±100	1 Ω	10 Ω	E24 E96
					±200	10.2 Ω	10 MΩ	
					±200	1 Ω	10 Ω	
FCF18 1218	1W	200V	400V	±5%(J)	±100	1 Ω	10 Ω	E24 Jumper
					±200	10.2 Ω	10 MΩ	
					±200	11 Ω	10 MΩ	

Note :

(1) RCWW = $(P \times R)^{1/2}$ or Max. RCWW listed above, whichever is lower.

RCWW : Working Voltage (V) · P : Rated Power (W) · R : Resistance Value (Ω)

Jumper : Max. 50mΩ.

DIMENSIONS

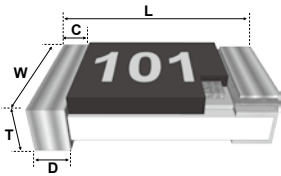

Type 1	L	W	C	D	T	unit: mm
FCF02	1.00±0.05	0.50±0.05	0.20±0.10	0.25±0.10	0.35±0.05	
FCF03	1.60±0.10	0.80±0.10	0.30±0.20	0.30±0.20	0.45±0.10	
FCF05	2.00±0.10	1.25±0.10	0.40±0.20	0.40±0.20	0.50±0.10	
FCF06	3.10±0.10	1.60±0.10	0.50±0.20	0.50±0.25	0.55±0.10	
FCF12	3.10±0.10	2.60±0.15	0.50±0.25	0.50±0.25	0.55±0.10	
FCF20	5.00±0.20	2.50±0.20	0.65±0.25	0.60±0.25	0.55±0.10	
FCF25	6.40±0.20	3.20±0.20	0.65±0.25	0.90±0.25	0.60±0.10	
FCF18	3.05±0.15	4.60±0.20	0.45±0.25	0.50±0.25	0.55±0.10	

POWER DE-RATING CURVE

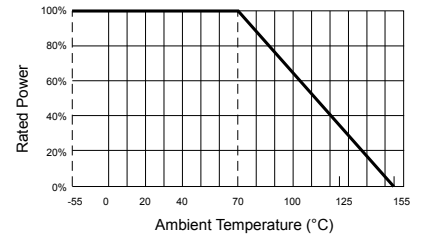

Maximum dissipation in percentage of rated power as a function of the ambient temperature for 0402, 0603, 0805, 1206, 1210, 2010, 2512, 1218

MLCC

Chip R

Coil

Thin Film Lead Free High Precision Chip Resistors

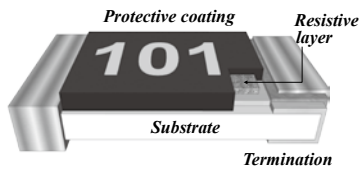

FEATURES

- High reliability and stability of 0.3% and below per customer request.
- Metal Thin Film Ni/Cr/Si,...etc. Resistive element.
- High performance of TCR 50ppm and below per customer request.
- Low current noise.
- Meet AEC-Q200, RoHS compliant.

APPLICATION

- Automotive industry.
- Medical equipment.
- Measuring instrument.
- Portable measuring equipment.
- Communication device

PART NUMBER

FAF	05	F	T	-	1002	P	Special Code
Type □□□□	Size □□	Tolerance □	Packing □	Watt □	R Value □□□□	TCR	
FAF Thin Film	01 0201 02 0402 03 0603 05 0805 06 1206 12 1210 20 2010 25 2512	T = ±0.01% A = ±0.05% B = ±0.1% C = ±0.25% D = ±0.5% F = ±1%	Paper tape T = 5 Kpcs V = 10Kpcs U = 15 Kpcs Plastic tape P = 4Kpcs X = 8Kpcs	"-" Standard A = 1/16W B = 1/10W C = 1/8W D = 1/4W E = 1/3W F = 1/2W G = 3/4W H = 1W R = 2/5W T = 1/20W	XXXX >=1R 1% 4 digit 5% 3 digit ("-" means a blank)	No special code- Null special code- "-" B = 2PPM C = 3PPM W = 5PPM V = 10PPM S = 15PPM Q = 25PPM P = 50PPM	"Null" Standard HC = Anti-Sulfuration M = Meet AEC-Q200 MF = Anti-Sulfuration & AEC-Q200 MH = Tantalum nitride Anti- Sulfuration & AEC-Q200

FCF	340	J	T	-	473	Special Code	
Type □□□□	Size □□□□	Tolerance □	Packing □	Watt □	R Value □□□□		
FAF Thin Film Array	340 0603x4 (8P4R Convex)	B = ±0.1% C = ±0.25% D = ±0.5% F = ±1%	Paper tape T = 5 Kpcs V = 10Kpcs	"-" Standard	XXXX >=1R 1% 4 digit 5% 3 digit	No special code- Null special code- "-" Q = 25PPM P = 50PPM	"Null" Standard

RATING

Standard Type - General High Precision

Standard Type	Power Rating @ 70°C	Max. RCWV (V)	Max. Overload Voltage (V)	Temperature Coefficient of Resistance (ppm/°C)	Resistance Tolerance (%)	Resistance Range		Resistance Range Meet AEC-Q200		Standard Resistance Values
						Min.	Max.	Min.	Max.	
0201	1/32W	15	30			100Ω	12KΩ	NA	NA	
0402	1/16W	50	100			10Ω	255KΩ	10Ω	100KΩ	
0603	1/16W	50	100			3.9Ω	1MΩ	4.7Ω	330KΩ	
0805	1/10W	100	200			4.7Ω	2MΩ	4.7Ω	1MΩ	
1206	1/8W	200	400	±25	±0.1	1Ω	2.49MΩ	4.7Ω	1MΩ	E24
1210	1/4W	200	400	±50	±0.25	4.7Ω	2.49MΩ	10Ω	1MΩ	E96
2010	1/2W	200	400		±0.5	4.7Ω	3MΩ	10Ω	1.5MΩ	
2512	3/4W	200	400		±1.0	1Ω	3MΩ	10Ω	1.5MΩ	
2512	3/4W	200	400					4.7Ω	3MΩ	

Function Type - Power High Precision

Standard Type	Power Rating @ 70°C	Max. RCWV (V)	Max. Overload Voltage (V)	Temperature Coefficient of Resistance (ppm/°C)	Resistance Tolerance (%)	Resistance Range		Resistance Range Meet AEC-Q200		Standard Resistance Values
						Min.	Max.	Min.	Max.	
0201	1/20W	15	30	±25	±0.5	27Ω	12KΩ	NA	NA	
				±50	±1.0	27Ω	22.1KΩ	NA	NA	
0402	1/10W	50	100			10Ω	255KΩ	10Ω	100KΩ	
0603	1/10W	75	150			3.9Ω	1MΩ	4.7Ω	330KΩ	
0805	1/8W	150	300	±25	±0.1	4.7Ω	2MΩ	4.7Ω	1MΩ	E24
1206	1/4W	200	400	±50	±0.25	1Ω	2.5MΩ	4.7Ω	1MΩ	E96
1210	2/5W	200	400		±0.5	4.7Ω	2.5MΩ	10Ω	1MΩ	
2010	3/4W	200	400		±1.0	4.7Ω	3MΩ	10Ω	1.5MΩ	
2512	1W	200	400	±50		1Ω	3MΩ	10Ω	1.5MΩ	

Thin Film Lead Free High Precision Chip Resistors

RATING

Function Type - Special (± 10 & ± 15)TCR High Precision

Narrow TCR Type*	Power Rating @ 70°C	Max. RCWV (V)	Max. Overload Voltage (V)	Temperature Coefficient of Resistance (ppm/°C)	Resistance Tolerance (%)	Resistance Range		Resistance Range Meet AEC-Q200		Standard Resistance Values
						Min.	Max.	Min.	Max.	
0402	1/10W	50	100			10Ω	100KΩ	10Ω	60KΩ	
0603	1/10W	75	150		±0.01	4.7Ω	200KΩ	4.7Ω	150KΩ	
0805	1/8W	150	300		±0.05	4.7Ω	400KΩ	4.7Ω	400KΩ	
1206	1/4W	200	400	±10	±0.1	4.7Ω	500KΩ	4.7Ω	500KΩ	E24
1210	2/5W	200	400	±15	±0.25	10Ω	600KΩ	10Ω	600KΩ	E96
2010	3/4W	200	400		±0.5	10Ω	1MΩ	10Ω	1MΩ	
2512	1W	200	400		±1.0	10Ω	1.5MΩ	10Ω	1.5MΩ	

Function Type -Special TCR (± 2 & ± 3) High Precision

Narrow TCR Type*	Power Rating @ 70°C	Max. RCWV (V)	Max. Overload Voltage (V)	Temperature Coefficient of Resistance (ppm/°C)	Resistance Tolerance (%)	Resistance Range		Resistance Range Meet AEC-Q200		Standard Resistance Values
						Min.	Max.	Min.	Max.	
0402	1/10W	50	100			10Ω	8KΩ	10Ω	8KΩ	
0603	1/10W	75	150		±0.01	4.7Ω	40KΩ	4.7Ω	40KΩ	
0805	1/8W	150	300		±0.05	4.7Ω	80KΩ	4.7Ω	80KΩ	
1206	1/4W	200	400	±3	±0.1	4.7Ω	120KΩ	4.7Ω	120KΩ	E24
1210	2/5W	200	400	±2	±0.25	4.7Ω	150KΩ	10Ω	150KΩ	E96
2010	3/4W	200	400		±0.5	4.7Ω	360KΩ	10Ω	360KΩ	
2512	1W	200	400		±1.0	4.7Ω	600KΩ	10Ω	600KΩ	

Anti-Sulfuration Type- Power High Precision

Narrow TCR Type*	Power Rating @ 70°C	Max. RCWV (V)	Max. Overload Voltage (V)	Temperature Coefficient of Resistance (ppm/°C)	Resistance Tolerance (%)	Resistance Range		Resistance Range Meet AEC-Q200		Standard Resistance Values
						Min.	Max.	Min.	Max.	
0402	1/10W	50	100			10Ω	255KΩ	10Ω	100KΩ	
0603	1/10W	75	150			4.7Ω	1MΩ	4.7Ω	330KΩ	
0805	1/8W	150	300		±0.1	4.7Ω	2MΩ	10Ω	1MΩ	
1206	1/4W	200	400	±25	±0.25	1Ω	2.5MΩ	10Ω	1MΩ	E24
1210	2/5W	200	400	±50	±0.5	4.7Ω	2.5MΩ	10Ω	1MΩ	E96
2010	3/4W	200	400		±1.0	4.7Ω	3MΩ	10Ω	1.5MΩ	
2512	1W	200	400			1Ω	3MΩ	10Ω	1.5MΩ	

Tantalum nitride Type - Special TCR High Precision

Narrow TCR Type*	Power Rating @ 70°C	Max. RCWV (V)	Max. Overload Voltage (V)	Temperature Coefficient of Resistance (ppm/°C)	Resistance Tolerance (%)	Resistance Range		Standard Resistance Values
						Min.	Max.	
0402	1/16W	50	100	±10	±0.1	40Ω	35KΩ	
0603	3/20W	75	150	±15	±0.25	40Ω	130KΩ	E24
0805	1/5W	100	200	±25	±0.5	10Ω	350KΩ	E96
1206	2/5W	200	400	±50	±1.0	10Ω	1MΩ	

Type - Array

Type	Normal Type Power Rating @ 70°C	Max. RCWV (V)	Max. Overload Voltage (V)	Temperature Coefficient of Resistance (ppm/°C)	Resistance Tolerance (%)	Resistance Range		Standard Resistance Values
						Min.	Max.	
340 : 0603x4	1/10W	75	150	±25 ±50	±0.1 ±0.25 ±0.5 ±1.0	20Ω	200KΩ	E24 E96

Thin Film Lead Free High Precision Chip Resistors

DIMENSIONS

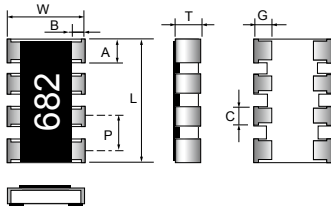
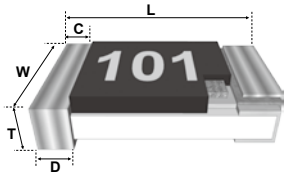

POWER DE-RATING CURVE

unit: mm

Size	L	W	C	D	T
0201	0.60±0.03	0.30±0.03	0.10±0.05	0.15±0.05	0.23±0.03
0402	1.00±0.10	0.50±0.05	0.30±0.15	0.30±0.15	0.35±0.05
0603	1.55±0.10	0.80±0.10	0.25±0.15	0.30±0.15	0.45±0.15
0805	2.00±0.10	1.25±0.10	0.25±0.20	0.40±0.20	0.50±0.15
1206	3.05±0.15	1.55±0.15	0.40±0.20	0.40±0.20	0.55±0.15
1210	3.10±0.10	2.60±0.15	0.50±0.20	0.50±0.20	0.55±0.10
2010	5.00±0.10	2.50±0.15	0.60±0.20	0.60±0.25	0.55±0.10
2512	6.35±0.10	3.20±0.15	0.60±0.20	0.90±0.25	0.55±0.10

Note : Precise data Pls refer to detail's spec.

unit: mm

Type	L	W	A	B	P	C	G	T
FAF340								
0603x4 Convex Type	3.20±0.15	1.50±0.15	0.60±0.10	0.40±0.15	0.80±0.10	0.40±0.10	0.30±0.15	0.45±0.10

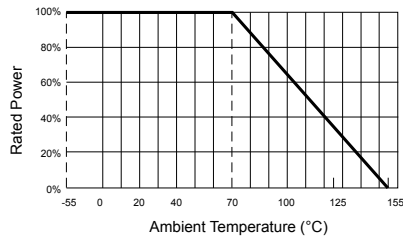

for 2512, 2010, 1210, 1206, 0805, 0603, 0402. Array

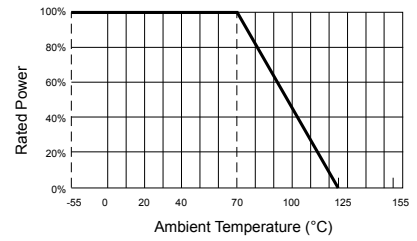

for 0201

MLCC

Chip R

Coil

APPENDIX

RESISTANCE MARKING

E 12 series
E 24 series

473

3 digit marking for $\pm 1\%$, $\pm 5\%$ E24 / E12 / E6
examples: **473** $47 \times 10^3 = 47K\Omega$, **1R5** = 1.5Ω

E 96 series

1542

4 digit marking for E96
examples: **1542** $154 \times 10^2 = 15K4\Omega$, **22R1** = 22.1Ω

02C

3 digit marking for E96 - 0603
examples: **02C** (Table 1) $102 \times 10^2 = 10K2\Omega$

• No Marking of 0402 / 0201 / 01005.

0603 1% MARKING TABLE (TABLE 1)

Code	E48	E96	Code	E48	E96	Code	E48	E96	Code	E48	E96
01	100	100	25	178	178	49	316	316	73	562	562
02		102	26		182	50		324	74		576
03	105	105	27	187	187	51	332	332	75	590	590
04		107	28		191	52		340	76		604
05	110	110	29	196	196	53	348	348	77	619	619
06		113	30		200	54		357	78		634
07	115	115	31	205	205	55	365	365	79	649	649
08		118	32		210	56		374	80		665
09	121	121	33	215	215	57	383	383	81	681	681
10		124	34		221	58		392	82		698
11	127	127	35	226	226	59	402	402	83	715	715
12		130	36		232	60		412	84		732
13	133	133	37	237	237	61	422	422	85	750	750
14		137	38		243	62		432	86		768
15	140	140	39	249	249	63	442	442	87	787	787
16		143	40		255	64		453	88		806
17	147	147	41	261	261	65	464	464	89	825	825
18		150	42		267	66		475	90		845
19	154	154	43	274	274	67	487	487	91	866	866
20		158	44		280	68		499	92		887
21	162	162	45	287	287	69	511	511	93	909	909
22		165	46		294	70		523	94		931
23	169	169	47	301	301	71	536	536	95	953	953
24		174	48		309	72		549	96		976

Code	A	B	C	D	E	F	G	H	X	Y	Z
Multiplier	10^0	10^1	10^2	10^3	10^4	10^5	10^6	10^7	10^{-1}	10^{-2}	10^{-3}

IEC-63 NOMINAL RESISTANCE / CAPACITANCE

E12	100																							
E3	100						220						470											
E6	100				150				220				330				470				680			
E12	100	120	150	180	220	270	330	390	470	560	680	820												
E24	100	110	120	130	150	160	180	200	220	240	270	300	330	360	390	430	470	510	560	620	680	750	820	910
E96	100	102	121	124	147	150	178	182	215	221	261	267	316	324	383	392	464	475	562	576	681	698	825	845
	105	107	127	130	154	158	187	191	226	232	274	280	332	340	402	412	487	499	590	604	715	732	866	887
	110	113	133	137	162	165	196	200	237	243	287	294	348	357	422	432	511	523	619	634	750	768	909	931
	115	118	140	143	169	174	205	210	249	255	301	309	365	374	442	453	536	549	649	665	787	806	953	976

APPENDIX

TAPE AND REEL PACKAGE

Taping specs are according to EIA RS-481

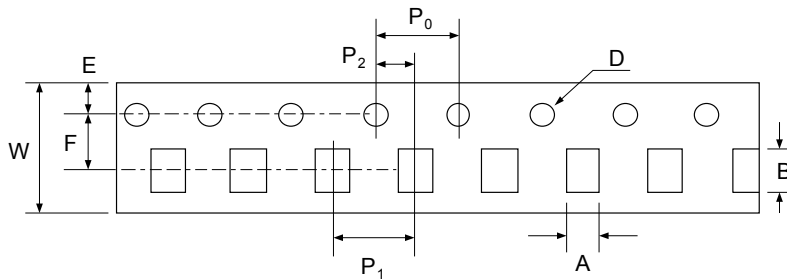

• Accumulated dimensional tolerance $40 \pm 0.2 \text{ mm}$

unit: mm

Size	A	B	W	F	E	P ₁	P ₂	P ₀	D
01005	0.24±0.03	0.45±0.03	8.00±0.20	3.50±0.05	1.75±0.10	2.00±0.05	2.00±0.05	4.00±0.10	1.50+0.10/-0
0201	0.37±0.05	0.67±0.05	8.00±0.20	3.50±0.05	1.75±0.10	2.00±0.05	2.00±0.05	4.00±0.10	1.50+0.10/-0
0402	0.70±0.10	1.20±0.10	8.00±0.30	3.50±0.05	1.75±0.10	2.00±0.10	2.00±0.05	4.00±0.10	1.50+0.10/-0
0603	1.10±0.20	1.90±0.20	8.00±0.30	3.50±0.05	1.75±0.10	4.00±0.10	2.00±0.05	4.00±0.10	1.50+0.10/-0
0805	1.65±0.20	2.40±0.20	8.00±0.30	3.50±0.05	1.75±0.10	4.00±0.10	2.00±0.05	4.00±0.10	1.50+0.10/-0
1206	2.00±0.20	3.60±0.20	8.00±0.30	3.50±0.05	1.75±0.10	4.00±0.10	2.00±0.05	4.00±0.10	1.50+0.10/-0
1210	3.00±0.20	3.60±0.20	8.00±0.30	3.50±0.05	1.75±0.10	4.00±0.10	2.00±0.05	4.00±0.10	1.50+0.10/-0
2010	2.80±0.20	5.50±0.20	12.00±0.30	5.50±0.05	1.75±0.10	4.00±0.10	2.00±0.05	4.00±0.10	1.50+0.10/-0
2512	3.50±0.20	6.70±0.20	12.00±0.30	5.50±0.05	1.75±0.10	4.00±0.10	2.00±0.05	4.00±0.10	1.50+0.10/-0

Reel Package

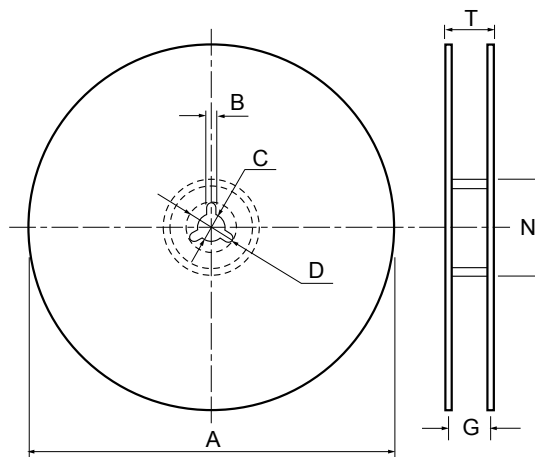

unit: mm

Size	Packaging Q'ty	Reel Diameter	A	N	C	D	B	G	T
01005	20Kpcs / Reel	7" reel	178.0±2.0	60.0±0.5	13.0±0.5	20min	2.0±0.5	9.0±1.0	14.9 max.
	15Kpcs / Reel	7" reel	178.0±2.0	60.0±0.5	13.0±0.5	20min	2.0±0.5	10.0±1.5	14.9 max.
0201	10Kpcs / Reel	7" reel	178.0±2.0	60.0±0.5	13.0±0.5	20min	2.0±0.5	10.0±1.5	14.9 max.
	0402	20Kpcs / Reel	10" reel	254.0±2.0	100.0±1.0	13.5±0.5	20min	2.0±0.5	10.0±1.5
	50Kpcs / Reel	13" reel	330.0±2.0	100.0±1.0	13.5±0.5	20min	2.0±0.5	10.0±1.5	14.9 max.
0603	5Kpcs / Reel	7" reel	178.0±2.0	60.0±0.5	13.0±0.5	20min	2.0±0.5	10.0±1.5	14.9 max.
0805	10Kpcs / Reel	10" reel	254.0±2.0	100.0±1.0	13.5±0.5	20min	2.0±0.5	10.0±1.5	14.9 max.
1206	20Kpcs / Reel	13" reel	330.0±2.0	100.0±1.0	13.5±0.5	20min	2.0±0.5	10.0±1.5	14.9 max.
1210		4Kpcs / Reel	7" reel	178.0±2.0	60.0±0.5	13.0±0.5	20min	2.0±0.5	13.8±1.5
2010	8Kpcs / Reel	10" reel	254.0±2.0	100.0±1.0	13.5±0.5	20min	2.0±0.5	13.8±1.5	16.7 max.
2512	16Kpcs / Reel	13" reel	330.0±2.0	100.0±1.0	13.5±0.5	20min	2.0±0.5	13.8±1.5	20.0 max.

MLCC

Chip R

Coil

APPENDIX

POWER CODE TABLE (TABLE 2)

Code	Power	Code	Power	Code	Power	Code	Power
T	1/20W	S	1/5W	Q	2/3W	K	3W
A	1/16W	R	2/5W	G	3/4W	L	4W
B	1/10W	D	1/4W	H	1W	M	5W
C	1/8W	E	1/3W	I	1.5W	N	10W
U	3/20W	F	1/2W	J	2W		

TCR CODE TABLE (TABLE 3)

Code	TCR	Code	TCR	Code	TCR	Code	TCR
G	1200	L	200	X	70	W	5
H	1000	Y	150	P	50	A	1
I	800	Z	250	Q	25	B	2
J	600	M	350	S	15	C	3
K	400	N	100	V	10		

SOLDERING TEMPERATURE CURVE

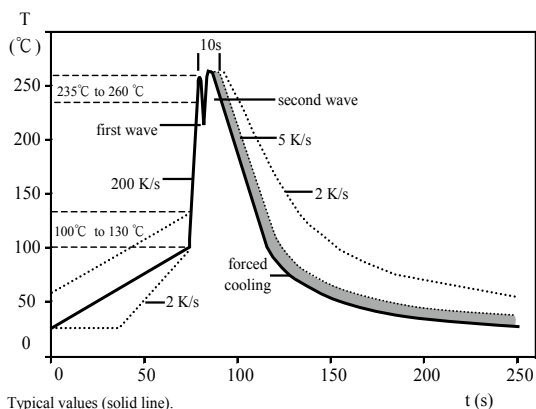

Typical values (solid line).
Process limits (dotted line).
WAVE soldering.

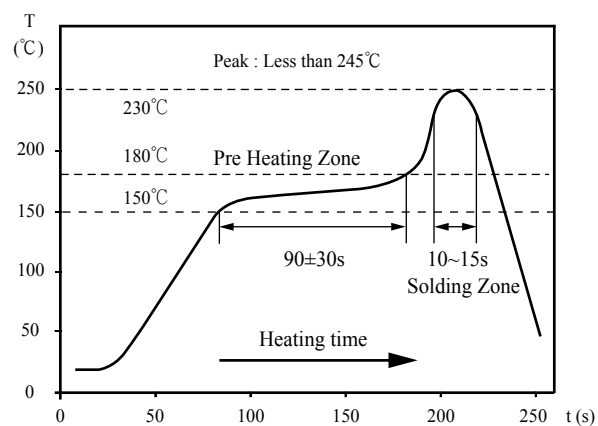

IR Reflow soldering.

RECOMMEND SOLDER PAD DIMENSION

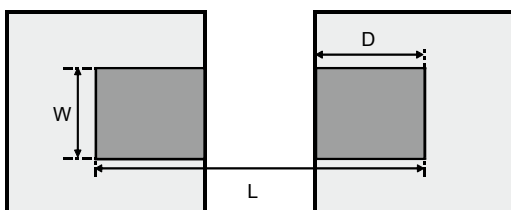

unit: mm

Type	W	D	L
FPF03	0.9	1	3
FPF05	1.3	1.15	3.5
FPF06	1.8	1.3	4.7
FPF12	3	1.3	4.7
FPF20	3	1.5	6.8
FPF25	3.7	2.45	7.6

* FPF/FPS SERIES



信昌電子陶瓷
Prosperity Dielectrics Co., Ltd.

■ Sales offices

台灣營業處 Taiwan Sales Office
總公司營業處 Sales Office - Headquarter
32668 桃園市楊梅區高獅路 566-1 號
No. 566-1, Kao-Shi Rd., Yangmei,
Taoyuan 32668, Taiwan
Tel: +886-3-475-3355
Fax: +886-3-485-4959
E-mail: service@pdc.com.tw

桃園營業處 Sales Office - Tao Yuan
33860 桃園市蘆竹區南山路二段 220-1 號
No. 220-1, Sec. 2, Nanshan Rd., Lujhu,
Taoyuan 33860, Taiwan
Tel: +886-3-322-4471
Fax: +886-3-322-9671
E-mail: service@pdc.com.tw
service-powder@pdc.com.tw

中國營業處 China Sales Office
東莞營業處 Sales Office - Dong Guan, China
523799 中國廣東省東莞市大朗鎮
犀牛陂象山工業區美景西路 638 號
No. 638, Mei Jing West Road Xiniupo
Administrative Zone Dalang Town,
Dong Guan City, Guangdong Province, China
Tel: +86-769-8555-0979
Fax: +86-769-8555-0972
E-mail: service@pdc.com.tw

■ Plants

楊梅廠 (MLCC) Yang Mei Plant
32668 桃園市楊梅區高獅路 566-1 號
No. 566-1, Kaoshi Rd., Yangmei,
Taoyuan 32668, Taiwan
Tel: +886-3-475-3355
Fax: +886-3-485-4959

桃園廠 (Chip-R, Powder) Tao Yuan Plant
33860 桃園市蘆竹區南山路二段 220-1 號
No. 220-1, Sec. 2, Nanshan Rd., Lujhu,
Taoyuan 33860, Taiwan
Tel: +886-3-322-4471
Fax: +886-3-322-9671

吳江廠 (Powder) Wu Jiang Plant
215200 中國江蘇省吳江市連東經濟開發區
龐金路 2588 路
No.2588, Pangjin Rd., Economic Development Zone,
Wujiang, Jiangsu 215200
Tel: +86-512-6300-8899
Fax: +86-512-6300-9988

永州廠 (Coil) Yong Zhou Plant
425000 中國湖南省永州市冷水灘區鳳凰園
陶源西路 136 號
No.136, Taoyuan West Road,
Phoenix Industrial Park, Lengshuitan District,
Yongzhou City, Hunan Province, China 42500
Tel: +86-746-8610-180
Fax: +86-746-8610-616

深圳廠 (Molding) Shen Zhen Plant
518104 中國廣東省深圳市寶安區
沙井街道步涌大興一路 16 號
No. 16, Daxing 1st Road, Dajing street, Baoan District,
Shenzhen City, Guangdong Province, China 518104
Tel: +86-755-2720-8041

X-ON Electronics

Largest Supplier of Electrical and Electronic Components

Click to view similar products for [Thick Film Resistors - SMD category](#):

Click to view products by [Prosperity manufacturer](#):

Other Similar products are found below :

[CR-05FL7--150R](#) [CR-05FL7--698K](#) [CR-12JP4--680R](#) [CRCW04021K20FKEE](#) [CRCW04028R20JNEE](#) [CRCW06032K10FKEC](#)
[CRCW06036K80FKEE](#) [M55342K03B499DRS6](#) [M55342K06B14E0RS6](#) [M55342K06B1E78RS3](#) [M55342K06B6E19RWL](#)
[M55342K06B6E81RS3](#) [M55342K09B5D62RS6](#) [M55342M05B200DRWB](#) [M55342M06B26E7RS3](#) [M55342M06B4K70MS3](#)
[742C083750JTR](#) [MCR01MZPF1202](#) [MCR01MZPF1601](#) [MCR01MZPF1800](#) [MCR01MZPF6201](#) [MCR01MZPF9102](#) [MCR01MZPJ121](#)
[MCR01MZPJ125](#) [MCR01MZPJ751](#) [MCR03EZHJ103](#) [MCR03EZPFX2004](#) [MCR03EZPJ270](#) [MCR03EZPJ821](#) [MCR10EZPF1102](#)
[MCR10EZPF2700](#) [MCR18EZPJ330](#) [RC1005F1152CS](#) [RC1005F1182CS](#) [RC1005F1372CS](#) [RC1005F1912CS](#) [RC1005F203CS](#)
[RC1005F2052CS](#) [RC1005F3011CS](#) [RC1005F303CS](#) [RC1005F4321CS](#) [RC1005F471CS](#) [RC1005F4751CS](#) [RC1005F5621CS](#)
[RC1005F6041CS](#) [RC1005J121CS](#) [RC1005J122CS](#) [RC1005J154CS](#) [RC1005J180CS](#) [RC1005J181CS](#)