

信昌電子陶瓷股份有限公司  
Prosperity Dielectrics Co., Ltd.

No.566-1, Gaoshi Rd., Lujhu, Yangmei Dist., Taoyuan City 32668, Taiwan, R.O.C.  
Tel. : +886-3-4753355 Fax : +886-3-4854959

**SPECIFICATION FOR APPROVAL**

DATE :

CUSTOMER : \_\_\_\_\_

PART NAME : \_\_\_\_\_ Thick Film Lead Free Chip Resistor Networks

CUSTOMER'S DWG. NO. : \_\_\_\_\_

CUSTOMER'S PART NO. : \_\_\_\_\_

PDC PART NO. : **FCF ARRAY SERIES APPROVED**

DESCRIPTION. : \_\_\_\_\_

ACTION	"V"	CUSTOMER'S SIGNATURE	NOTE
RESULT			
FULL APPROVED			
CONDITIONAL APPROVED			
REJECTED			

OUR ACTION	SIGNATURE
PREPARED By	<i>Jenny Tseng</i>
CHECKED By	<i>Tony Chou</i>
APPROVED By	<i>Byron Tsai</i>

CUSTOMER SIGNATURE FOR ACCEPTANCE

**Features**

- High density packaging provides higher productivity.
- Stable convex terminal reduces assembly costs.
- Compatible with flow and reflow soldering.
- RoHS compliant & Halogen Free.

**Applications**

- Computer
- Mobile phone
- Camcorder
- Portable audio
- Battery charger
- Hard Disk Driver

**Configuration**

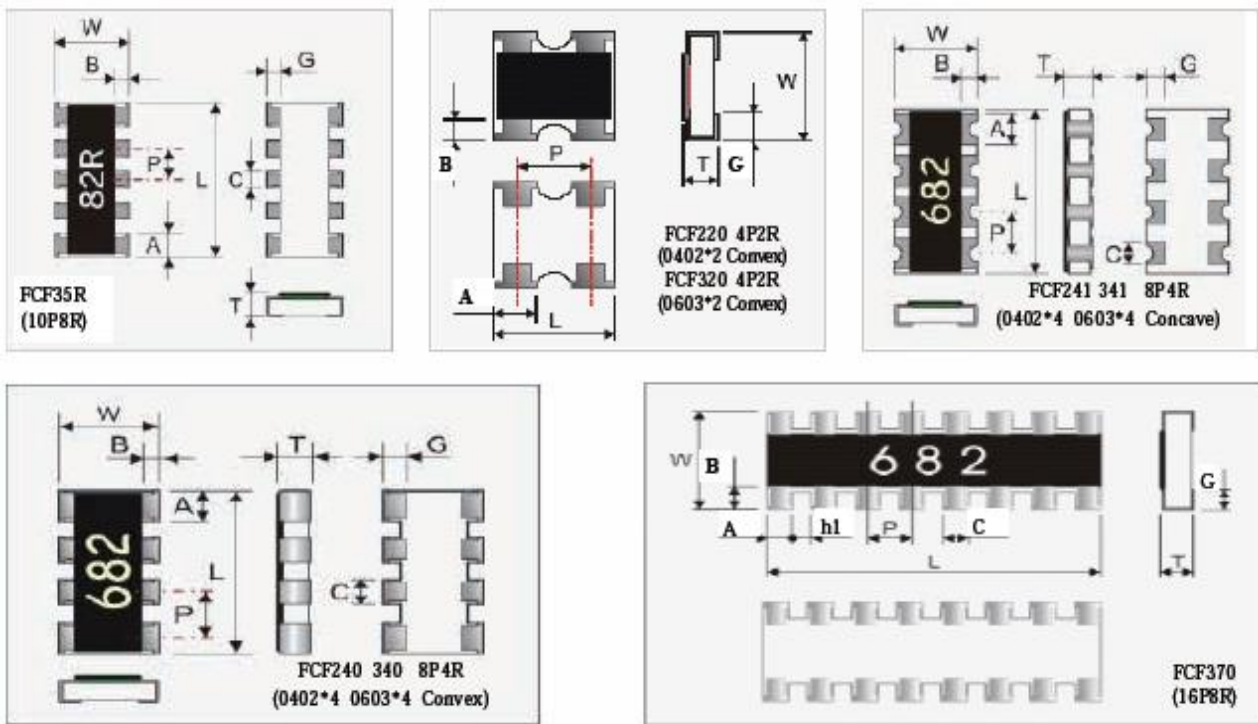

**Dimensions**

TYPE	L	W	T	B	G	P	C	A	h1
FCF220	1.00±0.10	1.00±0.10	0.35±0.10	0.20±0.15	0.25±0.17	0.65±0.10	-	0.34±0.10	-
FCF240	2.00±0.10	1.00±0.10	0.45±0.10	0.20±0.10	0.25±0.10	0.50±0.05	0.30±0.05	0.40±0.10	-
FCF241	2.00±0.10	1.00±0.10	0.45±0.10	0.20±0.15	0.25±0.10	0.50±0.05	0.25±0.05	0.25±0.05	-
FCF320	1.60±0.20	1.50±0.10	0.50±0.10	0.30±0.15	0.30±0.15	1.00±0.10	-	0.60±0.10	-
FCF340	3.20±0.20	1.60±0.10	0.50±0.10	0.30±0.20	0.30±0.20	0.80±0.10	0.45±0.10	0.60±0.15	-
FCF341	3.20 +0.20/-0.10	1.60 +0.20/-0.10	0.60±0.10	0.35±0.15	0.50±0.15	0.80±0.10	0.50±0.15	0.60±0.15	-
FCF35R	3.30±0.20	1.60±0.15	0.55±0.10	0.40±0.15	0.40±0.15	0.64±0.05	0.40±0.15	0.50±0.05	-
FCF370	4.00±0.20	1.60±0.15	0.45±0.10	0.30±0.25	0.30±0.20	0.50±0.20	0.30±0.10	0.40±0.20	0.20±0.10

unit:mm

■ Power Derating Curve

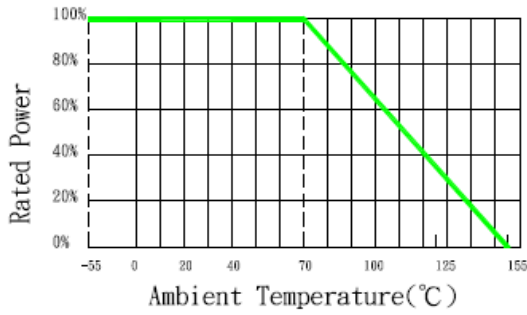

Maximum dissipation in percentage of rated power as a function of the ambient temperature.

■ Circuit

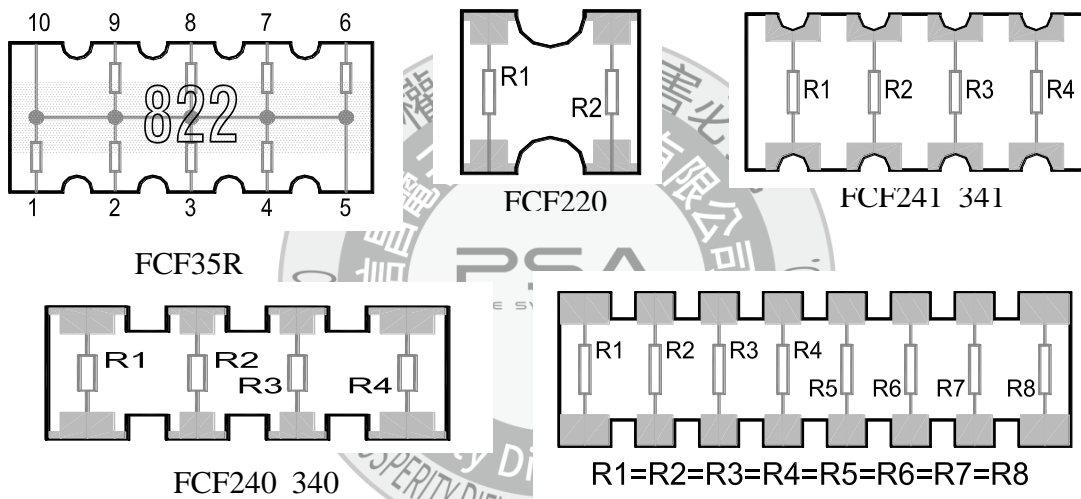

■ Rating

Type	Size	Termination Construction	Power Rating at 70°C	Max. RCWV	Max. Overload Voltage	Tolerance (%)	Temperature Coefficient (TCR; ppm/°C)	Resistance Range		Standard Resistance Values
								Min.	Max.	
FCF220	4P2R 0402*2	Convex	1/16W	25V	50V	±5% (J)	±300 ±400	0Ω/10Ω 3Ω	1MΩ 9.1Ω	E-24
FCF240	8P4R 0402*4	Convex	1/16W	50V	100V	±5% (J)	±200 -300~+500	0Ω/10Ω 3Ω	1MΩ 9.1Ω	E-24
						±1% (F)	±200	0Ω/10Ω	1MΩ	
FCF320	4P2R 0603*2	Convex	1/10W	50V	100V	±5% (J) ±1% (F)	±200 -300~+500	0Ω/10Ω 1Ω	1MΩ 9.1Ω	E-24
FCF340	8P4R 0603*4	Convex	1/10W	50V	100V	±5% (J)	±200 -300~+500	0Ω/10Ω 1Ω	1MΩ 9.1Ω	E-24
						±1% (F)	±200	0Ω/10Ω	1MΩ	
FCF35R	10P8R	Convex	1/16W	25V	50V	±5% (J)	±200	10Ω	100KΩ	E-24
FCF370	16P8R	Convex	1/16W	50V	100V	±5% (J) ±1% (F)	±200	0Ω/10Ω	100KΩ	E-24
FCF241	8P4R 0402*4	Concave	1/16W	25V	50V	±5% (J) ±1% (F)	±300	0Ω/3Ω	1MΩ	E-24
FCF341	8P4R 0603*4	Concave	1/10W	50V	100V	±5% (J) ±1% (F)	±200	0Ω/10Ω	1MΩ	E-24

0Ω(Jumper) : ⊙ Maximum resistance Rmax < 50mΩ.

## Soldering Temperature Curve

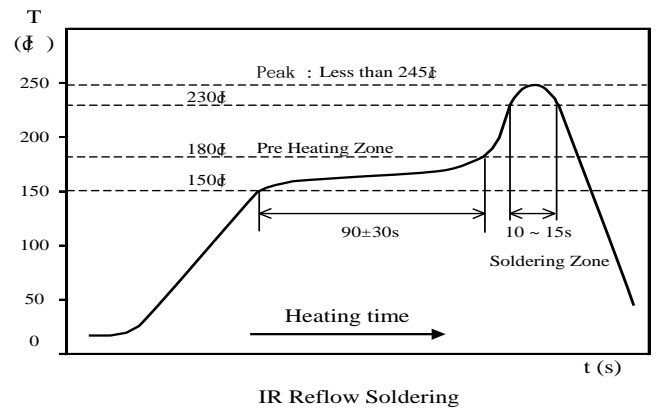
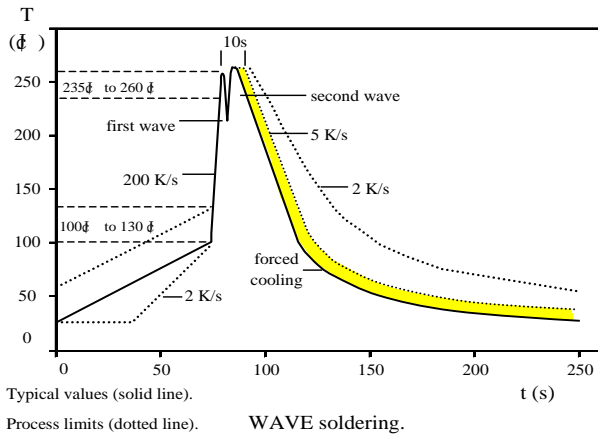

## Part Number

<b>FCF</b>	<b>340</b>	<b>J</b>	<b>T</b>	<b>- 473</b>
Type	Size	Tolerance	Packing	GM
FCF	220 : 0402*2	F : ± 1%	T : Paper tape - 5Kpcs	
	240 : 0402*4(Convex)	J : ± 5%	V : Paper tape - 10Kpcs	
	241 : 0402*4(Concave)		W : Paper tape - 20Kpcs	
	320 : 0603*2(Convex)			
	340 : 0603*4(Convex)			
	341 : 0603*4(Concave)			
	35R : 10P8R			
	370 : 16P8R			

## Resistance Marking

- E - 24 SERIES



3 digit marking for ±1% & ±5%  
examples **682**  $68 \times 10^2 = 6.8 \text{ K}\Omega$

No marking for FCF220 chip resistors array.

## Standard resistance value

E3	10			22			47										
E6	10	15	22	33	47	68											
E12	10	12	15	18	22	27	33	39	47	56	68	82					
E24	10	11	12	13	15	16	18	20	22	24	27	30	33	36	39	43	47
	51	56	62	68	75	82	91										

**SPECIFICATION**

**■ Tape And Reel Package**

Taping specs are according to EIA RS-481

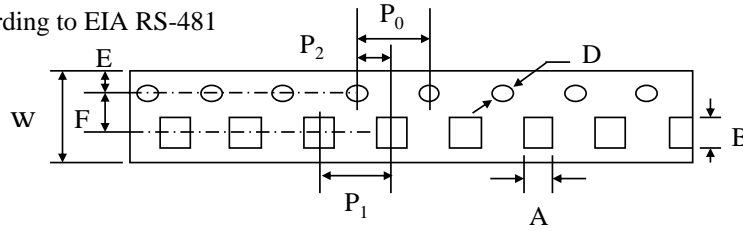

Accumulated dimensional tolerance  $40\pm 0.2\text{mm}$

Size	A	B	W	F	E	P1	P2	P0	D
0402*2	1.15±0.10	1.15±0.10	8.00±0.30	3.50±0.20	1.75±0.10	2.00±0.05	2.00±0.05	4.00±0.10	1.50+0.10/-0
0402*4 (Convex Concave)	1.20±0.20	2.20±0.20	8.00±0.30	3.50±0.20	1.75±0.10	2.00±0.05	2.00±0.05	4.00±0.10	1.50+0.10/-0
0603*2 (Convex)	1.80±0.10	1.80±0.10	8.00±0.30	3.50±0.10	1.75±0.10	4.00±0.10	4.00±0.10	4.00±0.10	1.50+0.10/-0
8P4R (Convex Concave)	2.00±0.20	3.60±0.20	8.00±0.30	3.50±0.20	1.75±0.10	4.00±0.10	2.00±0.05	4.00±0.10	1.50+0.10/-0
10P8R	1.85+0.20/-0	3.45+0.20/-0	8.00±0.30	3.50±0.20	1.75±0.10	4.00±0.10	2.00±0.05	4.00±0.10	1.50+0.10/-0
16P8R	1.80+0.20/-0	4.20+0.20/-0	12.00±0.10	5.50±0.05	1.75±0.10	4.00±0.10	2.00±0.05	4.00±0.10	1.50+0.10/-0

(unit: mm)

• Reel Package

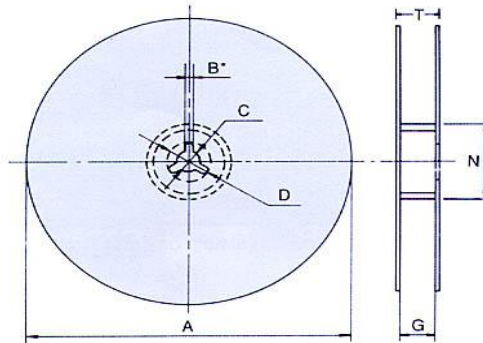

Size	Packaging Q'ty	A	N	C	D	B	G	T
0402*2 0402*4 (Convex , Concave) 0603*2 (Convex) 8P4R (Convex , Concave) 10P8R 16P8R	5Kpcs / Reel	178.0±2.0	60.0±0.5	13.0±0.5	20min	2.0±0.5	10.0±1.5	14.9 max.
8P4R	10Kpcs / Reel	254.0±2.0	100.0±1.0	13.5±0.5	20min	2.0±0.5	10.0±1.5	14.9 max.
	20Kpcs / Reel	330.0±2.0	100.0±1.0	13.5±0.5	20min	2.0±0.5	10.0±1.5	14.9 max.

(unit: mm)

**SPECIFICATION**

**Specification And Test Methods**

ITEM	SPECIFICATION	TEST METHOD
DC Resistance	J : ±5% , F: ±1% Zero ohm Jumper < 50mΩ	<b>IEC 60115-1 / JIS C 5201-1 , Clause 4.5</b> Measure the resistance value.
Short time Overload	J: ΔR ≤ ± (2% + 0.1 Ω) F: ΔR ≤ ± (1% + 0.05 Ω)	<b>IEC 60115-1 / JIS C 5201-1 , Clause 4.13</b> 2.5×Rated voltage or Max. Overload Voltage for 5 sec. measure resistance after 30 minutes
Solderability	Over 95% of termination must be covered with solder	<b>IEC 60115-1 / JIS C 5201-1 , Clause 4.17</b> After immersing flux, dip in the 235±2°C molten solder bath for 2±0.5 sec
Resistance to Solder Heat	J: ΔR ≤ ± (1% + 0.1 Ω) F: ΔR ≤ ± (0.5% + 0.05 Ω) No mechanical damage	<b>IEC 60115-1 / JIS C 5201-1 , Clause 4.18</b> With 260±5°C for 10±1 sec.
Temperature Coefficient of Resistance (TCR)	Size: 0402*2,0402*4 ± 300 ppm/°C Size:0603*2, 0603*4, 10P8R, 16P8R ± 200 ppm/°C	<b>IEC 60115-1 / JIS C 5201-1 , Clause 4.8</b> Test temperature : 25°C (T1) → -55°C (T2) 25°C (T1) → +155°C (T2) $TCR (ppm/°C) = \frac{R2-R1}{R1} \times \frac{1}{T2-T1} \times 10^6$ T1: 25°C T2: Test temperature R1: Resistance at reference temperature (T1) R2: Resistance at test temperature (T2)
Load Life Humidity	J: ΔR ≤ ± (3% + 0.1 Ω) F: ΔR ≤ ± (1% + 0.05 Ω)	<b>IEC 60115-1 / JIS C 5201-1 , Clause 4.24</b> Maintain the temperature of the resistor at 40±2°C and 90~95% R.H. with the rated voltage applied. Cycle ON for 1.5 hours and OFF for 0.5 hour for 1000+48/-0 hours. After 1~4 hour, measure the resistance value.
Load Life	J: ΔR ≤ ± (3% + 0.1 Ω) F: ΔR ≤ ± (1% + 0.05 Ω)	<b>IEC 60115-1 / JIS C 5201-1 , Clause 4.25</b> Permanent resistance change after 1000+48/-0 hours (1.5 hours ON , 0.5 hour OFF) at RCWV or Max. Keep the resistor at 70±2°C ambient
Temperature Cycle	J: ΔR ≤ ± (1% + 0.1 Ω) F: ΔR ≤ ± (0.5% + 0.05 Ω) No mechanical damage	<b>IEC 60115-1 / JIS C 5201-1 , Clause 4.19</b> Repeat 5 cycles as follows -55°C (30 min.) + 25°C (2~3 min.) +125°C (30 min.) + 25°C (2~3 min.) for FCF370 -55°C (30 min.) + 25°C (2~3 min.) +155°C (30 min.) + 25°C (2~3 min.) for FCF220,FCF240,FCF241,FCF340,FCF341,FCF35R
Insulation Resistance	Between termination and coating must be over 1000MΩ	<b>IEC 60115-1 / JIS C 5201-1 , Clause 4.6</b> Test voltage: 100±15V
Bending Strength	J: ΔR ≤ ± (1% + 0.1 Ω) F: ΔR ≤ ± (0.5% + 0.05 Ω) No mechanical damage	<b>IEC 60115-1 / JIS C 5201-1 , Clause 4.33</b> Resistance change after bended on the 90mm PCB. Bend: 1mm for FCF370 2mm for FCF220,FCF240,FCF241, FCF320, FCF340, FCF341,FCF35R

All product specification and data are subject to change without notice

## X-ON Electronics

Largest Supplier of Electrical and Electronic Components

*Click to view similar products for [Resistor Networks & Arrays](#) category:*

*Click to view products by [Prosperity](#) manufacturer:*

Other Similar products are found below :

[CSC06A0122K0GEJ](#) [CSC08A01470KGEK](#) [M8340105M1202GGD03](#) [M8340105M4700JGD03](#) [M8340107K1471FGD03](#)  
[M8340108K2402GGD03](#) [M8340108K3240FGD03](#) [M8340108K3743FGD03](#) [M8340108K4991FGD03](#) [M8340108K6192FGD03](#)  
[M8340108K6202GGD03](#) [M8340109K4700GGD03](#) [M8340109MA010GHD03](#) [744C083101JTR](#) [EXB-U18240JX](#) [744C083270JTR](#)  
[745C102472JP](#) [745X101103JP](#) [MDP1603100KGE04](#) [770101223](#) [MNR04M0APJ471](#) [MNR14E0APJ100](#) [MNR18E0APJ102](#)  
[MNR18E0APJ680](#) [ACAS06S0830339P100](#) [ACAS06S0830343P100](#) [ACAS06S0830344P100](#) [RAVF164DJT68K0](#) [RM2012A-102/104-](#)  
[PBVW10](#) [RM2012A-102503-PBVW10](#) [RM2012A-502104-PBVW10](#) [NRSN04I4J220TRF](#) [NRSN06I4J330TRF](#) [NRSNA4I4J330TRF](#)  
[8B472TR4](#) [ACAS06S0830341P100](#) [ACAS06S0830342P100](#) [ACAS06S0830345P100](#) [EXB-18N390JX](#) [EXB-V4N100JV](#)  
[CSC09A014K70JEK](#) [M8340105K1502GGD03](#) [M8340105K8251FGD03](#) [M8340105M1001JCD03](#) [M8340105M1002GCD03](#)  
[M8340106K4701GGD03](#) [M8340107K1004GGD03](#) [M8340107K3402FCD03](#) [M8340108K1000FGD03](#) [M8340108K1000GGD03](#)