



信昌電子陶瓷股份有限公司

Prosperity Dielectrics Co., Ltd.

No.566-1, Kaoshi Rd., Yangmei, Taoyuan 32668, Taiwan (R.O.C.)

Tel : 886-3-4753355

Fax : 886-3-4854959

Messrs. : 一般共用

Date : 2023/06/05

APPROVAL SHEET

Product Name : Medium Voltage Multilayer Ceramic Chip Capacitors

Part No. : FM Series

Description : Size 0402~2225, C0G/X7R, 100Vdc~630Vdc

PREPARED BY	APPROVED BY

信昌電子陶瓷股份有限公司

PROSPERITY DIELECTRICS CO., LTD.

桃園市場梅區高獅路 566-1 號 <http://www.pdc.com.tw>

Tel : 03-4753355 ext :

Fax : 03-4854959

Contactor : _____ **Mobile :** _____



信昌電子陶瓷股份有限公司

Prosperity Dielectrics Co., Ltd.

No.566-1, Kaoshi Rd., Yangmei, Taoyuan 32668, Taiwan (R.O.C.)

Tel : 886-3-4753355

Fax : 886-3-4854959

SPECIFICATION

FOR

Product Name : Medium Voltage Multilayer Ceramic Chip Capacitors

Part No. : FM Series

Description : Size 0402~2225, C0G/X7R, 100Vdc~630Vdc

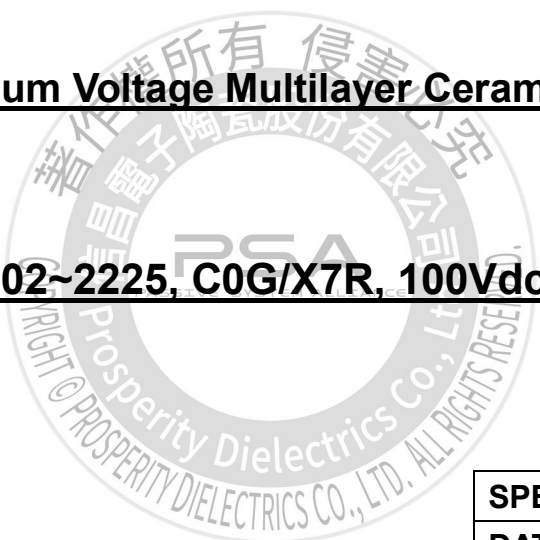

SPEC. No. : FM-000-001-26
DATE : 2023/06/05

DRAWN BY	CHECEKED BY	APPROVED BY
<i>Jane Hsiao</i>	<i>Yvens Chou</i>	<i>Jason Lin</i>

1. INTRODUCTION

FM Series green type capacitors are manufactured by using green materials without lead and cadmium. These capacitors feature series connection of multi-layer capacitor units in a MLCC to realize high voltage performance. Reliable performances are built-in through exact formulation of dielectric powders, preparation of conductive paste, advanced automatic manufacturing, and strict quality control to assure excellent control in dielectric thickness, electrode integrity, and electrode-to-termination continuity.

2. FEATURES

- a. Medium voltage in a given case size.
- b. High reliability and stability.
- c. RoHS & HALOGEN compliant.

3. APPLICATIONS

- a. DC to DC converter.
- b. High voltage coupling/DC blocking.
- c. Back-lighting inverters.
- d. Snubbers in high frequency power converters.

4. HOW TO ORDER

FM	31	X	471	K	251	P	X	G
PDC Family	Size	Dielectric	Capacitance	Tolerance	Rated Voltage	Packaging	Thickness	Control Code
Table 1	Table 2	Table 3	Table 4	Table 5	Table 6	Table 7	Table 8	Table 9

Table 1 PDC Family	
Code	Description
FM	100V≤Rated Voltage≤630V series

Table 6 Rated Voltage					
Code	Description	Code	Description	Code	Description
101	100Vdc	251	250Vdc	501	500Vdc
201	200Vdc	401	400Vdc	631	630Vdc

Table 2 Size					
Code	Description	Code	Description	Code	Description
15	0402 (1005)	32	1210 (3225)	52	2211 (5728)
18	0603 (1608)	42	1808 (4520)	55	2220 (5750)
21	0805 (2012)	43	1812 (4532)	56	2225 (5763)
31	1206 (3216)	46	1825 (4563)		

Table 3 Dielectric Material Characteristics			
Code	Description	Code	Description
N	COG	X	X7R

Table 7 Packaging Type			
Code	Description	Code	Description
B	Bulk	T	Tray package
E	Tape and 7" Reel, Embossed Tape	P	Tape and 7" Reel, Paper Tape
K	Tape and 10" Reel, Embossed Tape	D	Tape and 10" Reel, Paper Tape
L	Tape and 13" Reel, Embossed Tape	G	Tape and 13" Reel, Paper Tape

Table 4 Capacitance Rule Code			
Code	Description	Code	Description
R47	0.47pF	102	102=10x10 ² =1000pF
OR5	0.5pF	104	104=10x10 ⁴ =100nF
100	100=10x10 ⁰ =10pF	106	106=10x10 ⁶ =10μF

Table 8 Thickness Description					
Code	Description	Code	Description	Code	Description
A	0.60 ± 0.10 mm	J	1.15 ± 0.15 mm	S	0.80 ± 0.07 mm
B	0.8 + 0.15/-0.10 mm	K	0.50 ± 0.20 mm	T	0.85 ± 0.10 mm
C	1.25 ± 0.10 mm	L	0.30 ± 0.03 mm	U	0.50 ± 0.10 mm
D	1.40 ± 0.15 mm	M	0.95 ± 0.10 mm	V	0.20 ± 0.02 mm
E	1.60 ± 0.20 mm	N	0.50 ± 0.05 mm	W	0.50 ± 0.10 mm
F	2.00 ± 0.20 mm	O	3.50 ± 0.20 mm	X	0.80 ± 0.10 mm
G	2.50 ± 0.30 mm	P	1.60 +0.3/-0.10 mm	Z	0.25 ± 0.03 mm
H	2.80 ± 0.30 mm	Q	0.50 +0.02/-0.05 mm		
I	1.25 ± 0.20 mm	R	3.10 ± 0.30 mm		

Table 5 Tolerance					
Code	Description	Code	Description	Code	Description
A	±0.05 pF	J	±5 %	X	+10%~+20%
B	±0.10 pF	K	±10 %		
C	±0.25 pF	L	0% ~ +10%		
D	±0.50 pF	M	±20 %		
F	±1 %	N	-5% ~ +10%		
G	±2 %	P	±0.02 pF		
H	±3 %	Q	±0.03 pF		
I	-10% ~ 0%	Z	-20% ~ +80%		

Table 9 Special Control Code	
Code	Description
G	RoHS Compliant
Q	Surface Coating (Size 1206~2225)

5. EXTERNAL DIMENSIONS

Size Inch (mm)	L (mm)	W (mm)	Code / T (mm)	M _B (mm)	
0402(1005)	1.00±0.10	0.50±0.10	See No.4 Reference Table 8	0.25 +0.05/-0.10	
0603(1608)	1.60±0.15	0.80±0.15		0.40±0.15	
0805(2012)	2.00±0.20	1.25±0.20		0.50±0.20	
1206(3216)	3.20±0.20 3.20 +0.30/-0.10 [#]	1.60±0.20 1.60 +0.30/-0.10 [#]		0.60±0.20	
1210(3225)	3.20±0.30	2.50±0.30		0.75±0.35	
1808(4520)	4.50±0.40	2.00±0.25		0.75±0.35	
1812(4532)	4.50±0.40	3.20±0.30		0.75±0.35	
1825(4563)	4.50±0.40	6.30±0.40		0.75±0.35	
2220(5750)	5.70±0.40	5.00±0.40		0.85±0.35	
2225(5763)	5.70±0.40	6.30±0.40		0.85±0.35	

Fig. 5.1 The outline of MLCC

[#]For 1206 size P thickness products.

6. GENERAL ELECTRICAL DATA

Dielectric	C0G	X7R
Size	0402, 0603, 0805, 1206, 1210, 1808, 1812, 1825, 2220, 2225	0402, 0603, 0805, 1206, 1210, 1808, 1812, 1825, 2220, 2225
Rated voltage (WVDC)	100V, 200V, 250V, 500V, 630V	100V, 200V, 250V, 500V, 630V
Capacitance range	0.5pF ~ 100nF	100pF ~ 820nF
Capacitance tolerance	Reference to Table5	Reference to Table5
Tan δ	Cap. Rang	Q Spec.
	Cap.<30pF	Q≥400+20C
	Cap.≥30pF	Q≥1000
Capacitance & Tan δ Test condition	Measured at the condition of 30~70% related humidity	
	For 25°C at ambient temperature	Preconditioning for Class II MLCC : Perform a heat treatment at 150±10°C for 1 hour, then leave in ambient condition for 24±2 hours before measurement
	Cap. Rang	Test Condition
Insulation resistance at Ur	≥10GΩ or RxC≥500Ω-F, whichever is smaller	≥10GΩ or RxC≥100Ω-F, whichever is smaller
	-55 to +125°C	
Operating temperature		
Capacitance characteristic	±30ppm/°C	±15%
Termination	Cu/Ni/Sn (lead-free termination)	

7. CAPACITANCE RANGE

7-1. C0G

Dimension		0402			0603			0805					1206				
Cap(pF)	code	100V	200V	250V	100V	200V	250V	100V	200V	250V	500V	630V	100V	200V	250V	500V	630V
0.5	0R5	N	N	N	S	S	S	A	A	A	A	A					
1.0	1R0	N	N	N	S	S	S	A	A	A	A	A					
1.2	1R2	N	N	N	S	S	S	A	A	A	A	A	X			X	
1.5	1R5	N	N	N	S	S	S	A	A	A	A	A	X	X	X	X	X
1.8	1R8	N	N	N	S	S	S	A	A	A	A	A	X	X	X	X	X
2.2	2R2	N	N	N	S	S	S	A	A	A	A	A	X	X	X	X	X
2.7	2R7	N	N	N	S	S	S	A	A	A	A	A	X	X	X	X	X
3.3	3R3	N	N	N	S	S	S	A	A	A	A	A	X	X	X	X	X
3.9	3R9	N	N	N	S	S	S	A	A	A	A	A	X	X	X	X	X
4.7	4R7	N	N	N	S	S	S	A	A	A	A	A	X	X	X	X	X
5.6	5R6	N	N	N	S	S	S	A	A	A	A	A	X	X	X	X	X
6.8	6R8	N	N	N	S	S	S	A	A	A	A	A	X	X	X	X	X
8.2	8R2	N	N	N	S	S	S	A	A	A	A	A	X	X	X	X	X
10	100	N	N	N	S	S	S	A	A	A	A	A	X	X	X	X	X
12	120	N	N	N	S	S	S	A	A	A	A	A	X	X	X	X	X
15	150	N	N	N	S	S	S	A	A	A	A	A	X	X	X	X	X
18	180	N	N	N	S	S	S	A	A	A	A	A	X	X	X	X	X
22	220	N	N	N	S	S	S	A	A	A	A	A	X	X	X	X	X
27	270	N	N	N	S	S	S	A	A	A	A	A	X	X	X	X	X
33	330	N	N	N	S	S	S	A	A	A	A	A	X	X	X	X	X
39	390	N	N	N	S	S	S	A	A	A	A	A	X	X	X	X	X
47	470	N	N	N	S	S	S	A	A	A	A	A	X	X	X	X	X
56	560	N	N	N	S	S	S	A	A	A	A	A	X	X	X	X	X
68	680	N	N		S	S	S	A	A	A	A	A	X	X	X	X	X
82	820	N	N		S	S	S	A	A	A	X	X	X	X	X	X	X
100	101	N	N		S	S	S	A	A	X	X	X	X	X	X	X	X
120	121	N			S	S	S	A	A	X	C	C	X	X	X	X	X
150	151	N			S	S	S	A	X	X	C	C	X	X	X	X	X
180	181	N			S	S	S	A	X	C	C	C	X	X	X	X	X
220	221	N			S	S	S	A	C	C	C	C	X	X	X	X	X
270	271				S	B	B	A	C	C	C	C	X	X	M	M	M
330	331				S	B	B	A	C	C	C	C	X	X	M	M	M
390	391				S	B	B	X	C	C	C	C	X	X	M	M	M
470	471				S	B	B	X	C	C	I	I	X	M	M	M	M
560	561				S	B	B	X	C	C	I	I	X	M	C	C	C
680	681				S	B	B	X	C	C	I	I	X	M	C	C	C
820	821				S	B	B	X	C	C	I	I	X	M	E	E	E
1000	102				S	B	B	X	C	C	I	I	X	M	E	E	E
1200	122				B	B	B	X	C	C	I	I	X	M	E	E	E
1500	152				B	B	B	X	C	C	I	I	X	C	E	E	E
1800	182				B	B	B	X	C	C	I	I	X	C	E	E	E
2200	222				B	B	B	X	C	C	I	I	M	C	E	E	E
2700	272							C	C/I	C/I			M	C	E	E	E
3300	332							C	I	I			C	C	E	E	E
3900	392							C	I	I			C	E	E	E	E
4700	472							C	I	I			C	E	E	E	E
5600	562							C					E	E	E	E	E
6800	682							C					E	E	E	E	C/E
8200	822							C					E	E	E	E	E
10000	103							C					E	E	E	E	E
12000	123							C					P				
15000	153							C					P				
18000	183							C					P				
22000	223							C					P				
27000	273																
33000	333																

7. CAPACITANCE RANGE

7-1. C0G

Dimension		1210					1808					1812				
Cap(pF)	code	100V	200V	250V	500V	630V	100V	200V	250V	500V	630V	100V	200V	250V	500V	630V
2.2	2R2						C	C	C	C	C					
2.7	2R7						C	C	C	C	C					
3.3	3R3						C	C	C	C	C					
3.9	3R9						C	C	C	C	C					
4.7	4R7						C	C	C	C	C					
5.6	5R6						C	C	C	C	C					
6.8	6R8						C	C	C	C	C					
8.2	8R2						C	C	C	C	C					
10	100	M	M	M	M	M	C	C	C	C	C	C	C	C	C	C
12	120	M	M	M	M	M	C	C	C	C	C	C	C	C	C	C
15	150	M	M	M	M	M	C	C	C	C	C	C	C	C	C	C
18	180	M	M	M	M	M	C	C	C	C	C	C	C	C	C	C
22	220	M	M	M	M	M	C	C	C	C	C	C	C	C	C	C
27	270	M	M	M	M	M	C	C	C	C	C	C	C	C	C	C
33	330	M	M	M	M	M	C	C	C	C	C	C	C	C	C	C
39	390	M	M	M	M	M	C	C	C	C	C	C	C	C	C	C
47	470	M	M	M	M	M	C	C	C	C	C	C	C	C	C	C
56	560	M	M	M	M	M	C	C	C	C	C	C	C	C	C	C
68	680	M	M	M	M	M	C	C	C	C	C	C	C	C	C	C
82	820	M	M	M	M	M	C	C	C	C	C	C	C	C	C	C
100	101	M	M	M	M	M	C	C	C	C	C	C	C	C	C	C
120	121	M	M	M	M	M	C	C	C	C	C	C	C	C	C	C
150	151	M	M	M	M	M	C	C	C	C	C	C	C	C	C	C
180	181	M	M	M	M	M	C	C	C	C	C	C	C	C	C	C
220	221	M	M	M	M	M	C	C	C	C	C	C	C	C	C	C
270	271	M	M	M	M	M	C	C	C	F	F	C	C	C	C	C
330	331	M	M	M	M	M	C	C	C	F	F	C	C	C	C	C
390	391	M	M	M	M	M	C	C	C	F	F	C	C	C	C	C
470	471	M	M	M	M	M	C	C	C	F	F	C	C	C	C	C
560	561	M	M	M	M	M	C	C	C	F	F	C	C	C	C	C
680	681	M	M	M	M	M	C	C	C	F	F	C	C	C	C	C
820	821	M	M	M	M	M	C	C	C	F	F	C	C	C	C	C
1000	102	M	C	C	C	C	C	C	C	F	F	C	C	C	C	C
1200	122	M	C	C	C	C	C	C	C	F	F	C	C	C	C	C
1500	152	M	C	C	C	C	C	C	C	F	F	C	C	C	C	C
1800	182	M	C	C	C	C	C	C	C	F	F	C	C	C	C	C
2200	222	M	C	C	C	C	C	C	C	F	F	C	C	C	C	C
2700	272	M	C	C	C	C	C	C	C	F	F	C	C	C	C	C
3300	332	M	C	C	C	C	C	C	C	F	F	C	C	C	C	C
3900	392	M	C	C	C	C	C	C	C			C	C	C	C	C
4700	472	M	E/C	E/C	C	C	C	C	C			C	C	C	C	C
5600	562	C	E/C	E/C	C	C	C	E	E			C	C	C	C	C
6800	682	C	E	E	E/C	E/C	C	E	E			C	C	C	C	C
8200	822	C	E	E	E	E	E	F	F			C	C	C	C	C
10000	103	E	F	F	F	F	E	F	F			C	C	C	C	C
12000	123	E	C/E/F	C/E/F	F	F						C	E	E	E	E
15000	153	F	C/E/F	C/E/F	G	G						C	E	E	E	E
18000	183	F/G	E/F/G	E/F	G	G						E	F	F	F	F
22000	223	F/G	E/F/G	E/F	G	G						E	F	F	F	F
27000	273	F	F	F	G	G						F	G	G		
33000	333	F	F/G	F/G	G	G						F				
39000	393	F	F	F								G				
47000	473	F	F	F								G				
56000	563											G				
68000	683											G				
82000	823											G				
100000	104											G				

7. CAPACITANCE RANGE

7-1. C0G

Dimension		1825					2220					2225				
Cap(pF)	code	100V	200V	250V	500V	630V	100V	200V	250V	500V	630V	100V	200V	250V	500V	630V
10	100	F	F	F	F	F	F	F	F	F	F	F	F	F	F	F
12	120	F	F	F	F	F	F	F	F	F	F	F	F	F	F	F
15	150	F	F	F	F	F	F	F	F	F	F	F	F	F	F	F
18	180	F	F	F	F	F	F	F	F	F	F	F	F	F	F	F
22	220	F	F	F	F	F	F	F	F	F	F	F	F	F	F	F
27	270	F	F	F	F	F	F	F	F	F	F	F	F	F	F	F
33	330	F	F	F	F	F	F	F	F	F	F	F	F	F	F	F
39	390	F	F	F	F	F	F	F	F	F	F	F	F	F	F	F
47	470	F	F	F	F	F	F	F	F	F	F	F	F	F	F	F
56	560	F	F	F	F	F	F	F	F	F	F	F	F	F	F	F
68	680	F	F	F	F	F	F	F	F	F	F	F	F	F	F	F
82	820	F	F	F	F	F	F	F	F	F	F	F	F	F	F	F
100	101	F	F	F	F	F	F	F	F	F	F	F	F	F	F	F
120	121	F	F	F	F	F	F	F	F	F	F	F	F	F	F	F
150	151	F	F	F	F	F	F	F	F	F	F	F	F	F	F	F
180	181	F	F	F	F	F	F	F	F	F	F	F	F	F	F	F
220	221	F	F	F	F	F	F	F	F	F	F	F	F	F	F	F
270	271	F	F	F	F	F	F	F	F	F	F	F	F	F	F	F
330	331	F	F	F	F	F	F	F	F	F	F	F	F	F	F	F
390	391	F	F	F	F	F	F	F	F	F	F	F	F	F	F	F
470	471	F	F	F	F	F	F	F	F	F	F	F	F	F	F	F
560	561	F	F	F	F	F	F	F	F	F	F	F	F	F	F	F
680	681	F	F	F	F	F	F	F	F	F	F	F	F	F	F	F
820	821	F	F	F	F	F	F	F	F	F	F	F	F	F	F	F
1000	102	F	F	F	F	F	F	F	F	F	F	F	F	F	F	F
1200	122	F	F	F	F	F	F	F	F	F	F	F	F	F	F	F
1500	152	F	F	F	F	F	F	F	F	F	F	F	F	F	F	F
1800	182	F	F	F	F	F	F	F	F	F	F	F	F	F	F	F
2200	222	F	F	F	F	F	F	F	F	F	F	F	F	F	F	F
2700	272	F	F	F	F	F	F	F	F	F	F	F	F	F	F	F
3300	332	F	F	F	F	F	F	F	F	F	F	F	F	F	F	F
3900	392	F	F	F	F	F	F	F	F	F	F	F	F	F	F	F
4700	472	F	F	F	F	F	F	F	F	F	F	F	F	F	F	F
5600	562	F	F	F	F	F	F	F	F	F	F	F	F	F	F	F
6800	682	F	F	F	F	F	F	F	F	F	F	F	F	F	F	F
8200	822	F	F	F	F	F	F	F	F	F	F	F	F	F	F	F
10000	103	F	F	F	F	F	F	F	F	F	F	F	F	F	F	F
12000	123	F	F	F	F	F	F	F	F	F	F	F	F	F	F	F
15000	153	F	F	F	F	F	F	F	F	F	F	F	F	F	F	F
18000	183	F	F	F	F	F	F	F	F	F	F	F	F	F	F	F
22000	223	F	F	F	F	F	F	F	F	F	F	F	F	F	F	F
27000	273	F	F	F	F	F	F	F	F	F	F	F	F	F	F	F
33000	333	F	F	F	F	F	F	F	F	F	F	F	F	F	F	F
39000	393	F	F	F	G	G	F	F	F	G	F	F	F	F	F	F
47000	473	F	F	F			F	G	G	G	F	F	F	F	F	F
56000	563	F	G	G			F	G	G		G	F	G	G	G	G
68000	683	F	G	G			F	G	G		H	F	G	G	G	G
82000	823	G					G				H	F	G	G	G	
100000	104	G					G				H	G	G	G		
120000	124															
150000	154															
180000	184															
220000	224															

7. CAPACITANCE RANGE

7-2. X7R

Dimension		0402		0603		0805					1206					
Cap(pF)	code	100V	100V	200V	250V	100V	200V	250V	500V	630V	100V	200V	250V	500V	400 450	630V
100	101	N	S	B	B	X	X	X	X	X	X	C	C	C		C
120	121	N	S	B	B	X	X	X	X	X	X	C	C	C		C
150	151	N	S	B	B	X	X	X	X	X	X	C	C	C		C
180	181	N	S	B	B	X	X	X	X	X	X	C	C	C		C
220	221	N	S	B	B	X	X	X	X	X	X	C	C	C		C
270	271	N	S	B	B	X	X	X	X	X	X	C	C	C		C
330	331	N	S	B	B	X	X	X	X	X	X	C	C	C		C
390	391	N	S	B	B	X	X	X	X	X	X	C	C	C		C
470	471	N	S	B	B	X	X	X	X	X	X	C	C	C		C
560	561	N	S	B	B	X	X	X	X	X	X	C	C	C		C
680	681	N	S	B	B	X	X	X	X	X	X	C	C	C		C
820	821	N	S	B	B	X	X	X	X	X	X	C	C	C		C
1000	102	N	S	B	B	X	X	X	X	X	X	C	C	C		C
1200	122	N	S	B	B	X	X	X	X	X	X	C	C	C		C
1500	152	N	S	B	B	X	X	X	X	X	X	C	C	C		C
1800	182	N	S	B	B	X	X	X	X	X	X	C	C	C		C
2200	222	N	S	B	B	X	X	X	X	X	X	C	C	C		C
2700	272	N	S	B	B	X	X	X	X	X	X	C	C	C		C
3300	332	N	S	B	B	X	X	X	X	X	X	C	C	C		C
3900	392	N	S	B	B	X	X	X	X	X	X	C	C	C		C
4700	472	N	S	B	B	X	X	X	C	C	X	C	C	C		C
5600	562		S	B	B	X	X	X	C	C	X	C	C	C		C
6800	682		S	B	B	X	X	X	C	C	X	C	C	C		C
8200	822		S	B	B	X	X	X	C	C	X	C	C	C		C
10000	103		S	B	B	X	C	C	C	C	X	C	C	C		C
12000	123		B			X	C	C	C	C	X	C	C	C		C
15000	153		B			X	C	C	C	C	X	C	C	C		C
18000	183		B			X	C	C	C	C	X	C	C	C		C
22000	223		B			X	C	C	C	C	X	C	C	E		E
27000	273		B			C	C	C	C	C	X	C	C	E		E
33000	333		B			C	C	C	C		X	E	E	E		E
39000	393		B			C	C	C			X	E	E	E		E
47000	473		B			C	C	C			X	E	E	E		E
56000	563		B			C	C	C			X	E	E	E		E
68000	683		B			C	C	C			X	E	E		E	
82000	823		B			C	C				C	E	E		E	
100000	104		B			C	C				C	E	E		E	
120000	124					I					C	E	E			
150000	154					I					E	E	E			
180000	184					I					E	E	E			
220000	224					I					E	E	E			
270000	274					I					E					
330000	334					I					E					
390000	394					I					E					
470000	474					I					E					
560000	564										P					
680000	684										P					
820000	824										P					

7. CAPACITANCE RANGE

7-2. X7R

Dimension		1210					1808		1812						
Cap(pF)	code	100V	200V	250V	400 450	500V	630V	500V	630V	100V	200V	250V	450V	500V	630V
100	101														
120	121														
150	151							C	C						
180	181							C	C						
220	221	M	M	M		C	C	C	C						
270	271	M	M	M		C	C	C	C	C	C	C	C	C	C
330	331	M	M	M		C	C	C	C	C	C	C	C	C	C
390	391	M	M	M		C	C	C	C	C	C	C	C	C	C
470	471	M	M	M		C	C	C	C	C	C	C	C	C	C
560	561	M	M	M		C	C	C	C	C	C	C	C	C	C
680	681	M	M	M		C	C	C	C	C	C	C	C	C	C
820	821	M	M	M		C	C	C	C	C	C	C	C	C	C
1000	102	M	M	M		C	C	C	C	C	C	C	C	C	C
1200	122	M	M	M		C	C	C	C	C	C	C	C	C	C
1500	152	M	M	M		C	C	C	C	C	C	C	C	C	C
1800	182	M	M	M		C	C	C	C	C	C	C	C	C	C
2200	222	M	M	M		C	C	C	C	C	C	C	C	C	C
2700	272	M	M	M		C	C	C	C	C	C	C	C	C	C
3300	332	M	M	M		C	C	C	C	C	C	C	C	C	C
3900	392	M	M	M		C	C	C	C	C	C	C	C	C	C
4700	472	M	M	M		C	C	C	C	C	C	C	C	C	C
5600	562	M	M	M		C	C	F	F	C	C	C	C	C	C
6800	682	M	M	M		C	C	F	F	C	C	C	C	C	C
8200	822	M	M	M		C	C	F	F	C	C	C	C	C	C
10000	103	M	M	M		C	C	F	F	C	C	C	C	C	C
12000	123	M	M	M		C	C	F	F	C	C	C	C	C	C
15000	153	M	M	M		C	C	F	F	C	C	C	C	C	C
18000	183	M	M	M		C	C	F	F	C	C	C	C	C	C
22000	223	M	M	M		C	C	F	F	C	C	C	C	C	C
27000	273	M	M	M		E	E	F	F	C	C	C	C	C	C
33000	333	M	M	M		E	E	F	F	C	C	C	C	C	C
39000	393	M	M	M		E	E	F	F	C	C	C	C	C	C
47000	473	M	C	C		E	E	F	F	C	C	C	C	C	C
56000	563	M	C	E		E	E	F	F	C	C	C	F	F	F
68000	683	M	E	E		F/E	F/E	F	F	C	C	C	F	F	F
82000	823	M	E	E		F	F	F	F	C	C	C	F	F	F
100000	104	M	E	E		F	F			C	C	C	F	F	F
120000	124	M	E	E	G	G	G			C	C	C	G	G	G
150000	154	C	G	G	G	G	G			C	F	F	G	G	G
180000	184	C	G	G	G					C	F	F	G	G	G
220000	224	C	G	G	G					C	F	F	G	G	G
270000	274	E	G	G	G					C	F	F	G	G	
330000	334	E	G	G	G					C	F	F	G	G	
390000	394	G	G	G						C	F	F	G	G	
470000	474	G	G	G						F	F	F	G	G	
560000	564	G	G	G						F	G	G	G		
680000	684	F	G	G						F	G	G	G		
820000	824	F								F	G	G	H		

7. CAPACITANCE RANGE

7-2. X7R

Dimension		1825					2220					2225				
Cap(pF)	code	100V	200V	250V	500V	630V	100V	200V	250V	500V	630V	100V	200V	250V	500V	630V
1000	102	F	F	F	F	F	F	F	F	F	F	F	F	F	F	F
1200	122	F	F	F	F	F	F	F	F	F	F	F	F	F	F	F
1500	152	F	F	F	F	F	F	F	F	F	F	F	F	F	F	F
1800	182	F	F	F	F	F	F	F	F	F	F	F	F	F	F	F
2200	222	F	F	F	F	F	F	F	F	F	F	F	F	F	F	F
2700	272	F	F	F	F	F	F	F	F	F	F	F	F	F	F	F
3300	332	F	F	F	F	F	F	F	F	F	F	F	F	F	F	F
3900	392	F	F	F	F	F	F	F	F	F	F	F	F	F	F	F
4700	472	F	F	F	F	F	F	F	F	F	F	F	F	F	F	F
5600	562	F	F	F	F	F	F	F	F	F	F	F	F	F	F	F
6800	682	F	F	F	F	F	F	F	F	F	F	F	F	F	F	F
8200	822	F	F	F	F	F	F	F	F	F	F	F	F	F	F	F
10000	103	F	F	F	F	F	F	F	F	F	F	F	F	F	F	F
12000	123	F	F	F	F	F	F	F	F	F	F	F	F	F	F	F
15000	153	F	F	F	F	F	F	F	F	F	F	F	F	F	F	F
18000	183	F	F	F	F	F	F	F	F	F	F	F	F	F	F	F
22000	223	F	F	F	F	F	F	F	F	F	F	F	F	F	F	F
27000	273	F	F	F	F	F	F	F	F	F	F	F	F	F	F	F
33000	333	F	F	F	F	F	F	F	F	F	F	F	F	F	F	F
39000	393	F	F	F	F	F	F	F	F	F	F	F	F	F	F	F
47000	473	F	F	F	F	F	F	F	F	F	F	F	F	F	F	F
56000	563	F	F	F	F	F	F	F	F	F	F	F	F	F	F	F
68000	683	F	F	F	F	F	F	F	F	F	F	F	F	F	F	F
82000	823	F	F	F	F	F	F	F	F	F	F	F	F	F	F	F
100000	104	F	F	F	F	F	F	F	F	F	F	F	F	F	F	F
120000	124	F	F	F	F	F	F	F	F	F	F	F	F	F	F	F
150000	154	F	F	F	F	F	F	F	F	F	F	F	F	F	F	F
180000	184	F	F	F	F	F	F	F	F	F	F	F	F	F	F	F
220000	224	F	F	F	F	F	F	F	F	F	F	F	F	F	F	F
270000	274	F	F	F	F	F	F	F	F	F	F	F	F	F	F	F
330000	334	F	F	F	F	F	F	F	F	F	F	F	F	F	F	F
390000	394	F	F	F	F	F	F	F	F	F	F	F	F	F	F	F
470000	474	F	F	F	F	F	F	F	F	F	F	F	F	F	F	F
560000	564	F	F	F	G	G	F	F	F	G	G	F	F	F	F	F
680000	684	F	F	F			F	F	F	G	G	F	F	F		
820000	824	F	F	F			F	F	F	H	H	F	F	F		

8. RELIABILITY TEST CONDITIONS AND REQUIREMENTS

No.	Item	Test Condition	Requirements																		
1.	Visual and Dimensions	---	* No remarkable defect. * Dimensions to conform to individual specification sheet.																		
2.	Capacitance		* Shall not exceed the limits given in the detailed spec.																		
3.	Q/ D.F. (Tangent of loss angle)	* Class I : C0G Cap.≤1000pF, 1.0±0.2Vrms, 1MHz±10%. Cap.>1000pF, 1.0±0.2Vrms, 1KHz±10%. * Class II : (X7R) 1.0±0.2Vrms, 1KHz±10%.	<table border="1"> <thead> <tr> <th>Dielectric</th> <th>Q/D.F.</th> <th>Remark</th> </tr> </thead> <tbody> <tr> <td rowspan="2">Class I (C0G)</td> <td>Q≥1000</td> <td>Cap.≥30pF</td> </tr> <tr> <td>Q≥400+20C</td> <td>Cap.<30pF</td> </tr> <tr> <td rowspan="4">Class II</td> <td>D.F.≤2.5%</td> <td>X7R items</td> </tr> <tr> <td>D.F.≤3.5%</td> <td>X7R 0603≥0.047μF, 0805=0.1μF, 1206≥0.47μF</td> </tr> <tr> <td>D.F.≤5.0%</td> <td>X7R 0603≥0.068μF, 0805>0.1μF All Y5V items</td> </tr> <tr> <td>D.F.≤10.0%</td> <td>X7R 0805>0.22μF</td> </tr> </tbody> </table>	Dielectric	Q/D.F.	Remark	Class I (C0G)	Q≥1000	Cap.≥30pF	Q≥400+20C	Cap.<30pF	Class II	D.F.≤2.5%	X7R items	D.F.≤3.5%	X7R 0603≥0.047μF, 0805=0.1μF, 1206≥0.47μF	D.F.≤5.0%	X7R 0603≥0.068μF, 0805>0.1μF All Y5V items	D.F.≤10.0%	X7R 0805>0.22μF	
Dielectric	Q/D.F.	Remark																			
Class I (C0G)	Q≥1000	Cap.≥30pF																			
	Q≥400+20C	Cap.<30pF																			
Class II	D.F.≤2.5%	X7R items																			
	D.F.≤3.5%	X7R 0603≥0.047μF, 0805=0.1μF, 1206≥0.47μF																			
	D.F.≤5.0%	X7R 0603≥0.068μF, 0805>0.1μF All Y5V items																			
	D.F.≤10.0%	X7R 0805>0.22μF																			
4.	Temperature Coefficient (Temperature characteristic of capacitance)	* With no electrical load. <table border="1"> <thead> <tr> <th>T.C.</th> <th>Operating Temp.</th> </tr> </thead> <tbody> <tr> <td>C0G</td> <td>-55~125°C at 25°C</td> </tr> <tr> <td>X7R</td> <td>-55~125°C at 25°C</td> </tr> </tbody> </table>	T.C.	Operating Temp.	C0G	-55~125°C at 25°C	X7R	-55~125°C at 25°C	<table border="1"> <thead> <tr> <th>T.C.</th> <th>Capacitance Change</th> </tr> </thead> <tbody> <tr> <td>C0G</td> <td>Within ±30ppm/°C</td> </tr> <tr> <td>X7R</td> <td>Within ±15%</td> </tr> </tbody> </table>	T.C.	Capacitance Change	C0G	Within ±30ppm/°C	X7R	Within ±15%						
T.C.	Operating Temp.																				
C0G	-55~125°C at 25°C																				
X7R	-55~125°C at 25°C																				
T.C.	Capacitance Change																				
C0G	Within ±30ppm/°C																				
X7R	Within ±15%																				
5.	Insulation Resistance	<table border="1"> <thead> <tr> <th>Rated Vol.(V)</th> <th>Apply Voltage</th> <th>Test Condition</th> </tr> </thead> <tbody> <tr> <td>=100</td> <td>1 times of UR</td> <td>Max. 120 sec.</td> </tr> <tr> <td>200≤V≤500</td> <td>1 times of UR</td> <td>60 sec.</td> </tr> <tr> <td>>500</td> <td>500Vdc</td> <td>60 sec.</td> </tr> </tbody> </table>	Rated Vol.(V)	Apply Voltage	Test Condition	=100	1 times of UR	Max. 120 sec.	200≤V≤500	1 times of UR	60 sec.	>500	500Vdc	60 sec.	<table border="1"> <thead> <tr> <th>Dielectric</th> <th>Requirements</th> </tr> </thead> <tbody> <tr> <td>Class I</td> <td>≥10GΩ or RxC≥500Ω-F, whichever is smaller</td> </tr> <tr> <td>Class II</td> <td>≥10GΩ or RxC≥100Ω-F, whichever is smaller</td> </tr> </tbody> </table>	Dielectric	Requirements	Class I	≥10GΩ or RxC≥500Ω-F, whichever is smaller	Class II	≥10GΩ or RxC≥100Ω-F, whichever is smaller
Rated Vol.(V)	Apply Voltage	Test Condition																			
=100	1 times of UR	Max. 120 sec.																			
200≤V≤500	1 times of UR	60 sec.																			
>500	500Vdc	60 sec.																			
Dielectric	Requirements																				
Class I	≥10GΩ or RxC≥500Ω-F, whichever is smaller																				
Class II	≥10GΩ or RxC≥100Ω-F, whichever is smaller																				
6.	Solderability	* Solder temperature : 235±5°C for (0402~1210). * Solder temperature : 245±5°C for (1808~2225). * Dipping time : 2±0.5 sec.	* 75% min. coverage of all metalized area.																		
7.	Dielectric Strength (Voltage proof)	<table border="1"> <thead> <tr> <th>Rated Vol.(V)</th> <th>Condition</th> </tr> </thead> <tbody> <tr> <td>≤100</td> <td>2.5 times of UR</td> </tr> <tr> <td>100<V≤250</td> <td>2.0 times of UR</td> </tr> <tr> <td>250<V≤500</td> <td>1.5 times of UR</td> </tr> <tr> <td>=630</td> <td>1.2 times of UR</td> </tr> </tbody> </table> * Duration : 1 to 5 sec. * Charge and discharge current less than 50mA.	Rated Vol.(V)	Condition	≤100	2.5 times of UR	100<V≤250	2.0 times of UR	250<V≤500	1.5 times of UR	=630	1.2 times of UR	* No evidence of damage or flashover during test.								
Rated Vol.(V)	Condition																				
≤100	2.5 times of UR																				
100<V≤250	2.0 times of UR																				
250<V≤500	1.5 times of UR																				
=630	1.2 times of UR																				
8.	Resistance to Soldering Heat	* Solder temperature : 260±5°C. * Dipping time : 10±1 sec. * Preheating : 120 to 150°C for 1 minute before immerse the capacitor in a eutectic solder. * Before initial measurement (Class II only) : Perform 150 +0/-10°C for 1 hr and then set for 48±4 hrs at room temp. * Measurement to be made after keeping at room temp. for 24±2 hrs (Class I) or 48±4 hrs (Class II).	* No remarkable damage. * Cap. Change : C0G : Within ±2.5% or ±0.25pF, whichever is larger. X7R : Within ±7.5%. * Q/D.F. & I.R. : To meet the initial requirement. * 25% max. leaching on each edge.																		
9.	Temperature Cycle (Rapid change of temperature)	* Conduct the five cycles according to the temperatures and time. <table border="1"> <thead> <tr> <th>Step</th> <th>Temp.(°C)</th> <th>Time(min.)</th> </tr> </thead> <tbody> <tr> <td>1</td> <td>Min. operating temp. +0/-3</td> <td>30±3</td> </tr> <tr> <td>2</td> <td>Room temp.</td> <td>2~3</td> </tr> <tr> <td>3</td> <td>Max. operating temp. +3/-0</td> <td>30±3</td> </tr> <tr> <td>4</td> <td>Room temp.</td> <td>2~3</td> </tr> </tbody> </table> * Before initial measurement (Class II only) : Perform 150 +0/-10°C for 1 hr and then set for 48±4 hrs at room temp. * Measurement to be made after keeping at room temp. for 24±2 hrs (Class I) or 48±4 hrs (Class II).	Step	Temp.(°C)	Time(min.)	1	Min. operating temp. +0/-3	30±3	2	Room temp.	2~3	3	Max. operating temp. +3/-0	30±3	4	Room temp.	2~3	* No remarkable damage. * Cap. change : C0G : Within ±2.5% or ±0.25pF, whichever is larger. X7R : Within ±7.5%. * Q/D.F. : C0G : To meet the initial requirement. X7R, Y5V : D.F.≤150% of initial requirement. * I.R. : To meet the initial requirement.			
Step	Temp.(°C)	Time(min.)																			
1	Min. operating temp. +0/-3	30±3																			
2	Room temp.	2~3																			
3	Max. operating temp. +3/-0	30±3																			
4	Room temp.	2~3																			

8. RELIABILITY TEST CONDITIONS AND REQUIREMENTS

No.	Item	Test Condition	Requirements																							
10.	Humidity (Damp Heat) Steady State	* Test temp. : 40±2°C. * Humidity : 90~95%RH. * Test time : 500 +24/-0 hrs. * Measurement to be made after keeping at room temp. for 24±2 hrs (Class I) or 48±4 hrs (Class II).	* No remarkable damage. * Cap. change : C0G : Within ±5.0% or ±0.5pF, whichever is larger. X7R : Within ±12.5%. * Q/D.F. : C0G : Cap.>30pF, Q≥350; 10pF≤Cap.≤30pF, Q≥275+2.5C; Cap.<10pF, Q≥200+10C. X7R : D.F.≤200% of initial requirement. * I.R. (Class I) : ≥10GΩ or RxC≥500Ω-F, whichever is smaller. * I.R. (Class II) : ≥1GΩ or RxC≥10Ω-F, whichever is smaller.																							
11.	Humidity (Damp Heat) Load	* Test temp. : 40±2°C. * Humidity : 90~95% RH. * Test time : 500 +24/-0hrs. * To apply voltage : Rated voltage (Max. 500Vdc). * Measurement to be made after keeping at room temp. for 24±2 hrs (Class I) or 48±4 hrs (Class II).	* No remarkable damage. * Cap. change : C0G : Within ±7.5% or ±0.75pF, whichever is larger. X7R : Within ±12.5%. * Q/D.F. : C0G : Cap.≥30pF, Q≥200; Cap.<30pF, Q≥100+10/3C. X7R : D.F.≤200% of initial requirement. * I.R. : ≥500MΩ or RxC≥25Ω-F, whichever is smaller. X7R 100V : ≥500MΩ or RxC≥5Ω-F, whichever is smaller.																							
12.	High Temperature Load (Endurance)	* Test temp. : C0G, X7R : 125±3°C. <table border="1" style="margin-left: 20px;"> <thead> <tr> <th>Dielectric</th> <th>Rated Vol.(V)</th> <th>Apply Voltage</th> </tr> </thead> <tbody> <tr> <td rowspan="3">C0G X7R</td> <td>≤100</td> <td>2.0 times of U_R</td> </tr> <tr> <td>200≤V≤500</td> <td>1.5 times of U_R</td> </tr> <tr> <td>400V~450V</td> <td>1.2 times of U_R</td> </tr> <tr> <td></td> <td>=630</td> <td>1.2 times of U_R</td> </tr> </tbody> </table> * Exception items : <table border="1" style="margin-left: 20px;"> <thead> <tr> <th>Rated Vol.(V)</th> <th>Size</th> <th>Cap. Range</th> <th>Apply Voltage</th> </tr> </thead> <tbody> <tr> <td rowspan="2">100</td> <td>0603</td> <td>≥0.082μF</td> <td rowspan="2">150%</td> </tr> <tr> <td>0805</td> <td>≥0.12μF</td> </tr> </tbody> </table> * Test time : 1000 +24/-0 hrs. * Measurement to be made after keeping at room temp. for 24±2 hrs (Class I) or 48±4 hrs (Class II).	Dielectric	Rated Vol.(V)	Apply Voltage	C0G X7R	≤100	2.0 times of U _R	200≤V≤500	1.5 times of U _R	400V~450V	1.2 times of U _R		=630	1.2 times of U _R	Rated Vol.(V)	Size	Cap. Range	Apply Voltage	100	0603	≥0.082μF	150%	0805	≥0.12μF	* No remarkable damage. * Cap. change : C0G : Within ±3.0% or ±0.3pF, whichever is larger. X7R : Within ±12.5%. * Q/D.F. : C0G : Cap.>30pF, Q≥350; 10pF≤Cap.≤30pF, Q≥275+2.5C; Cap.<10pF, Q≥200+10C. X7R : D.F.≤200% of initial requirement. * I.R. : ≥1GΩ or RxC≥50Ω-F, whichever is smaller. X7R 100V : ≥1GΩ or RxC≥10Ω-F, whichever is smaller.
Dielectric	Rated Vol.(V)	Apply Voltage																								
C0G X7R	≤100	2.0 times of U _R																								
	200≤V≤500	1.5 times of U _R																								
	400V~450V	1.2 times of U _R																								
	=630	1.2 times of U _R																								
Rated Vol.(V)	Size	Cap. Range	Apply Voltage																							
100	0603	≥0.082μF	150%																							
	0805	≥0.12μF																								

8. RELIABILITY TEST CONDITIONS AND REQUIREMENTS

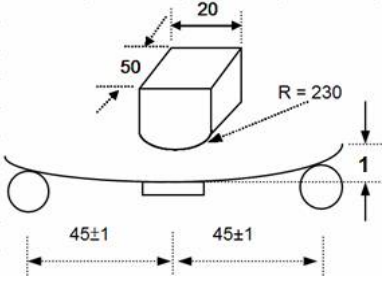
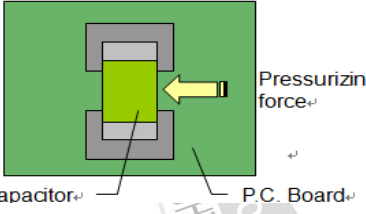
No.	Item	Test Condition	Requirements						
13	Resistance to Flexure of Substrate (Substrate bending test)	<p>* The middle part of substrate shall be pressurized by means of the pressurizing rod at a rate of about 1mm per second until the deflection becomes 1mm.</p>  <p>Unit : mm</p>	<p>* No remarkable damage.</p> <table border="1"> <thead> <tr> <th>Dielectric</th> <th>Cap. Change</th> </tr> </thead> <tbody> <tr> <td>Class I (C0G)</td> <td>Within ±3.0% or ±2.0pF, whichever is larger</td> </tr> <tr> <td>Class II (X7R)</td> <td>Within ±12.5%</td> </tr> </tbody> </table> <p>(This capacitance change means the change of capacitance under specified flexure of substrate from the capacitance measured before the test)</p>	Dielectric	Cap. Change	Class I (C0G)	Within ±3.0% or ±2.0pF, whichever is larger	Class II (X7R)	Within ±12.5%
Dielectric	Cap. Change								
Class I (C0G)	Within ±3.0% or ±2.0pF, whichever is larger								
Class II (X7R)	Within ±12.5%								
14.	Adhesive Strength of Termination (Robustness of termination)	<p>* Capacitors mounted on a substrate. A force of 5N(≤0603) or 10N(>0603) applied perpendicular to the place of substrate and parallel the line joining the center of terminations for 10±1 second.</p> 	<p>* No remarkable damage or removal of the terminations.</p>						
15.	Vibration Resistance	<p>* Vibration frequency : 10~55 Hz/min. * Total amplitude : 1.5mm. * Test time : 6 hrs. (Two hrs each in three mutually perpendicular directions) * Measurement to be made after keeping at room temp. for 24±2 hrs (Class I) or 48±4 hrs (Class II).</p>	<p>* No remarkable damage. * Cap. change and Q/D.F. : To meet the initial spec.</p>						

9. PACKAGE DIMENSION AND QUANTITY

Size	Thickness (mm)	Paper tape		Plastic tape	
		7" reel	13" reel	7" reel	13" reel
0402(1005)	0.50±0.05	10k	50k	-	-
	0.50 +0.02/-0.05	10k	50k	-	-
	0.50±0.20	10k	-	-	-
0603(1608)	0.50±0.10	4k	-	-	-
	0.80±0.07	4k	15k	-	-
	0.80 +0.15/-0.10	4k	15k	-	-
0805(2012)	0.50±0.10	4k	15k	-	-
	0.60±0.10	4k	15k	-	-
	0.80±0.10	4k	15k	-	-
	0.85±0.10	4k	15k	-	-
	1.25±0.10	-	-	3k	10k
1206(3216)	1.25±0.20	-	-	3k	10k
	0.80±0.10	4k	15k	-	-
	0.85±0.10	4k	15k	-	-
	0.95±0.10	-	-	3k	10k
	1.15±0.15	-	-	3k	10k
	1.25±0.10	-	-	3k	10k
	1.60±0.20	-	-	2k	10k
1210(3225)	1.60 +0.30/-0.10	-	-	2k	9k
	0.85±0.10	-	-	3k	10k
	0.95±0.10	-	-	3k	10k
	1.25±0.10	-	-	3k	10k
	1.60±0.20	-	-	2k	-
	2.00±0.20	-	-	1k	6k
1808(4520)	2.50±0.30	-	-	1k	6k
	1.25±0.10	-	-	2k	10k
	1.60±0.20	-	-	2k	8k
	2.00±0.20	-	-	1k	6k
1812(4532)	1.25±0.10	-	-	1k	5k
	1.60±0.20	-	-	1k	-
	2.00±0.20	-	-	1k	-
	2.50±0.30	-	-	0.5k	3k
	2.80±0.30	-	-	0.5k	-
1825(4563)	1.60±0.20	-	-	1k	-
	2.00±0.20	-	-	1k	-
	2.50±0.30	-	-	0.5k	-
	2.80±0.30	-	-	0.5k	-
2220(5750)	1.60±0.20	-	-	1k	-
	2.00±0.20	-	-	1k	-
	2.50±0.30	-	-	0.5k	-
2225(5763)	2.80±0.30	-	-	0.5k	-
	1.60±0.20	-	-	1k	-
	2.00±0.20	-	-	1k	-
	2.50±0.30	-	-	0.5k	-
	2.80±0.30	-	-	0.5k	-

Unit : pcs

9. PACKAGE DIMENSION AND QUANTITY

9.1. EMBOSSED TAPE DIMENSIONS

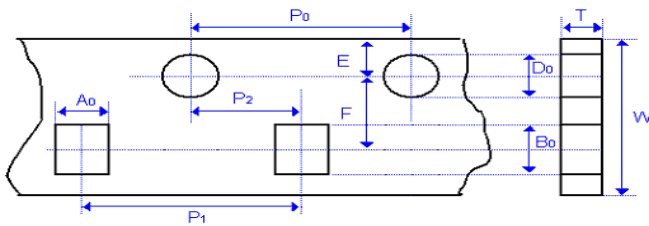

Fig. 9.1 The dimension of paper tape

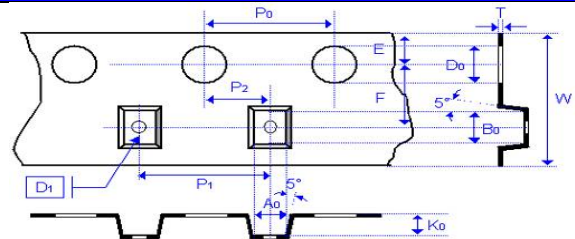

Fig. 9.2 The dimension of plastic tape

Size	0402	0603	0805	
Chip Thickness	0.50±0.05 0.50±0.10	0.80±0.07 0.80 +0.15/-0.1	0.80±0.10	1.25±0.10 1.25±0.20
A ₀	0.70±0.20	1.00 +0.05/-0.10	1.50±0.20	<1.80
B ₀	1.20±0.20	1.80±0.10	2.30±0.20	<2.70
T	≤0.80	0.95±0.05	0.95±0.05	0.23±0.05
K ₀	-	-	-	<2.50
W	8.00±0.10	8.00±0.10	8.00±0.10	8.00±0.10
P ₀	4.00±0.10	4.00±0.10	4.00±0.10	4.00±0.10
10xP ₀	40.00±0.10	40.00±0.20	40.00±0.20	40.00±0.20
P ₁	2.00±0.05	4.00±0.10	4.00±0.10	4.00±0.10
P ₂	2.00±0.05	2.00±0.05	2.00±0.05	2.00±0.05
D ₀	1.50 +0.10/-0	1.50 +0.10/-0	1.50 +0.10/-0	1.50 +0.10/-0
D ₁	-	-	-	1.00±0.10
E	1.75±0.05	1.75±0.05	1.75±0.05	1.75±0.10
F	3.50±0.05	3.50±0.05	3.50±0.05	3.50±0.05
Unit :	mm	mm	mm	mm

Size	1206			1210		1808	
Chip Thickness	0.80±0.10	0.95±0.10 1.25±0.10	1.60±0.20 1.60+0.3/-0.1	0.95±0.10 1.25±0.10 1.60±0.20	2.50±0.30	1.25±0.10 1.60±0.20	2.00±0.20
A ₀	2.00±0.10	<2.00	<2.50	<3.05	<3.20	<2.50	<2.50
B ₀	3.50±0.50	<3.70	<4.00	<3.80	<4.00	<5.30	<5.30
T	0.95±0.05	0.23±0.05	0.23±0.05	0.23±0.05	0.23±0.05	0.25±0.05	0.25±0.05
K ₀	-	<2.50	<2.50	<2.50	<3.50	<2.50	<2.50
W	8.00±0.10	8.00±0.10	8.00±0.10	8.00±0.10	8.00±0.10	12.00±0.20	12.00±0.20
P ₀	4.00±0.10	4.00±0.10	4.00±0.10	4.00±0.10	4.00±0.10	4.00±0.10	4.00±0.10
10xP ₀	40.00±0.20	40.00±0.20	40.00±0.20	40.00±0.20	40.00±0.20	40.00±0.20	40.00±0.20
P ₁	4.00±0.10	4.00±0.10	4.00±0.10	4.00±0.10	4.00±0.10	4.00±0.10	4.00±0.10
P ₂	2.00±0.05	2.00±0.05	2.00±0.05	2.00±0.05	2.00±0.05	2.00±0.05	2.00±0.05
D ₀	1.50 +0.10/-0	1.50 +0.10/-0	1.50 +0.10/-0	1.50 +0.10/-0	1.50 +0.10/-0	1.50 +0.10/-0	1.50 +0.10/-0
D ₁	-	1.00±0.10	1.50±0.10	1.50±0.10	1.00±0.10	1.50±0.10	1.50±0.10
E	1.75±0.10	1.75±0.10	1.75±0.10	1.75±0.10	1.75±0.10	1.75±0.10	1.75±0.10
F	3.50±0.05	3.50±0.05	5.50±0.05	5.50±0.05	3.50±0.05	5.50±0.05	5.50±0.05
Unit :	mm	mm	mm	mm	mm	mm	mm

9. PACKAGE DIMENSION AND QUANTITY

Size	1812		1825		2220	
Chip Thickness	1.25±0.10 1.60±0.20 2.00±0.20	2.50±0.30 2.80±0.30	1.60±0.20 2.00±0.20	2.50±0.30 2.80±0.30	1.40±0.15 1.60±0.20 2.00±0.20	2.50±0.30 2.80±0.30
A ₀	<3.90	<3.90	<6.80	<6.80	<5.80	<6.80
B ₀	<5.30	<5.30	<5.30	<5.30	<6.50	<6.50
T	0.25±0.05	0.25±0.05	0.30±0.10	0.30±0.10	0.30±0.10	0.30±0.10
K ₀	<2.50	<3.00	<2.50	<3.10	<2.50	<3.10
W	12.00±0.20	12.00±0.20	12.00±0.20	12.00±0.20	12.00±0.20	12.00±0.20
P ₀	4.00±0.10	4.00±0.10	4.00±0.10	4.00±0.10	4.00±0.10	4.00±0.10
10xP ₀	40.00±0.20	40.00±0.20	40.00±0.20	40.00±0.20	40.00±0.20	40.00±0.20
P ₁	8.00±0.10	8.00±0.10	8.00±0.10	8.00±0.10	8.00±0.10	8.00±0.10
P ₂	2.00±0.05	2.00±0.05	2.00±0.05	2.00±0.05	2.00±0.05	2.00±0.05
D ₀	1.50 +0.10/-0	1.50 +0.10/-0	1.50 +0.10/-0	1.50 +0.10/-0	1.50 +0.10/-0	1.50 +0.10/-0
D ₁	1.50±0.10	1.50±0.10	1.50±0.10	1.50±0.10	1.50±0.10	1.50±0.10
E	1.75±0.10	1.75±0.10	1.75±0.10	1.75±0.10	1.75±0.10	1.75±0.10
F	5.50±0.05	5.50±0.05	5.50±0.05	5.50±0.05	5.50±0.05	5.50±0.05
Unit :	mm	mm	mm	mm	mm	mm

Size	2225	
Chip Thickness	1.60±0.20 2.00±0.20	2.50±0.30 2.80±0.30
A ₀	<6.80	<6.80
B ₀	<6.50	<6.50
T	0.30±0.10	0.30±0.10
K ₀	<2.50	<3.10
W	12.00±0.20	12.00±0.20
P ₀	4.00±0.10	4.00±0.10
10xP ₀	40.00±0.20	40.00±0.20
P ₁	8.00±0.10	8.00±0.10
P ₂	2.00±0.05	2.00±0.05
D ₀	1.50 +0.10/-0	1.50 +0.10/-0
D ₁	1.50±0.10	1.50±0.10
E	1.75±0.10	1.75±0.10
F	5.50±0.05	5.50±0.05
Unit :	mm	mm

9. PACKAGE DIMENSION AND QUANTITY

9.2. REEL DIMENSIONS

Size	0201, 0402, 0603, 0805, 1206, 1210		1808, 1812, 1825, 2220, 2225
Reel size	7"	13"	7"
C	13.0 +0.5/-0.2	13.0 +0.7/-0.3	13.0 +0.5/-0.2
W ₁	8.4+1.5	8.4+1.5	12.4 +2.0/-0
W	14.4max	14.4max	shall accommodate tape width without interference
A	178.0 ±0.10	330.0 ±1.0	178.0 ±0.10
N	60.0 +1.0/-0	100 ±1.0	60.0 +1.0/-0

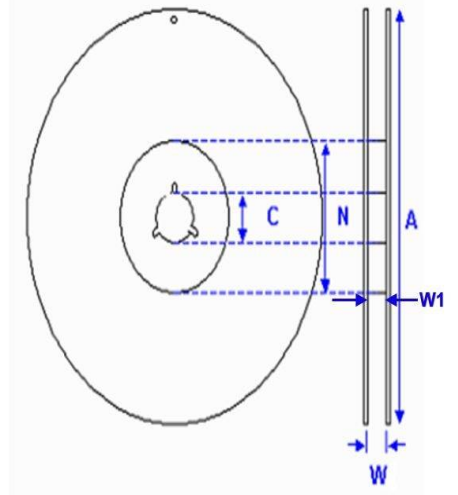
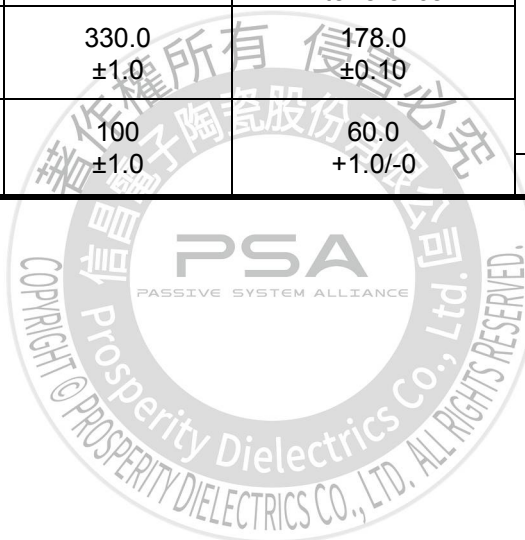

Fig. 9.3 The dimension of reel



10. APPLICATION NOTES

STORAGE

To prevent the damage of solderability of terminations, the following storage conditions are recommended :

Indoors under 5 ~ 40°C and 20% ~ 70% RH.

No harmful gases containing sulfuric acid, ammonia, hydrogen sulfide or chlorine.

Packaging should not be opened until the capacitors are required for use. If opened, the pack should be re-sealed as soon as is practicable. Taped product should be stored out of direct sunlight, which might promote deterioration in tape or adhesion performance. The product is recommended to be used within 12 months after shipment and checked the solderability before use.

HANDLING

Chip capacitors are dense, hard, brittle, and abrasive materials. They are liable to suffer mechanical damage, in the form of cracks or chips. Chip Capacitors should be handled with care to avoid contamination or damage. To use vacuum or plastic tweezers to pick up or plastic tweezers is recommended for manual placement. Tape and reeled packages are suitable for automatic pick and placement machine.

PREHEAT

In order to minimize the risk of thermal shock during soldering, a carefully controlled preheat is required. The rate of preheat should not exceed 3°C per second.

SOLDERING

Use mildly activated rosin fluxes do not use activated flux. The amount of solder in each solder joint should be controlled to prevent the damage of chip capacitors caused by the stress between solder, chips, and substrate.

a.) Hand soldering :

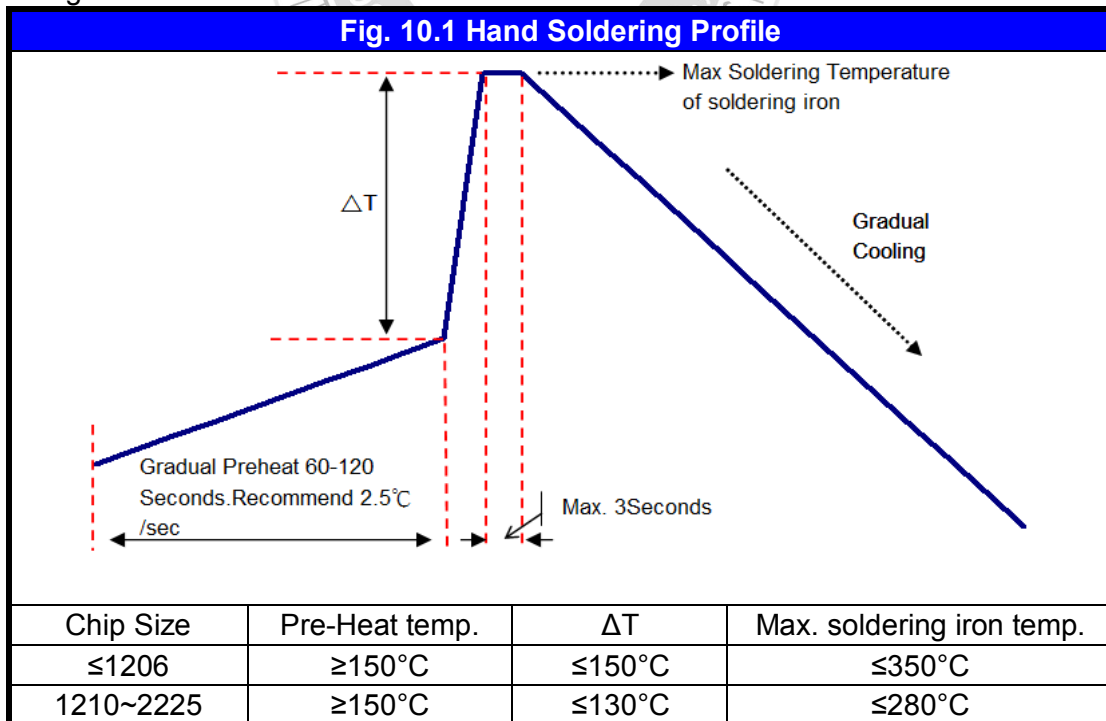

- * Soldering iron tip diameter ≤1.0 mm and wattage max. 20W.
- * The Capacitors shall be pre-heated and that the temperature gradient between the devices and the tip of the soldering iron.
- * The required amount of solder shall be melted on the soldering tip.
- * The tip of iron should not contact the ceramic body directly.
- * The Capacitors shall be cooled gradually at room temperature after soldering.
- * Forced air cooling is not allowed.

10. APPLICATION NOTES

b.) Reflow soldering :

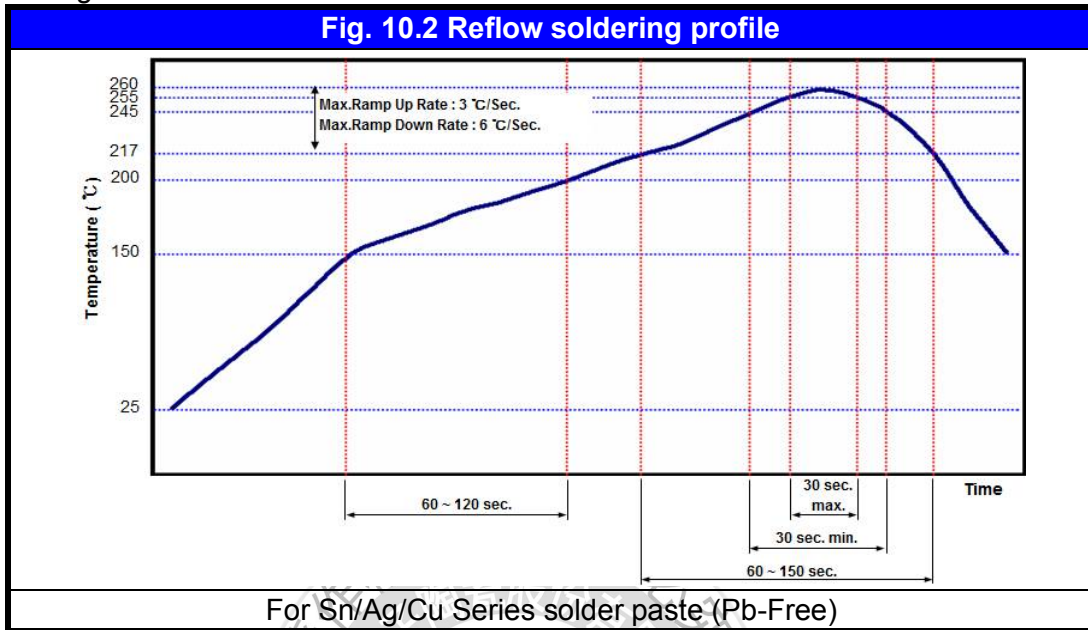

c.) Wave soldering :

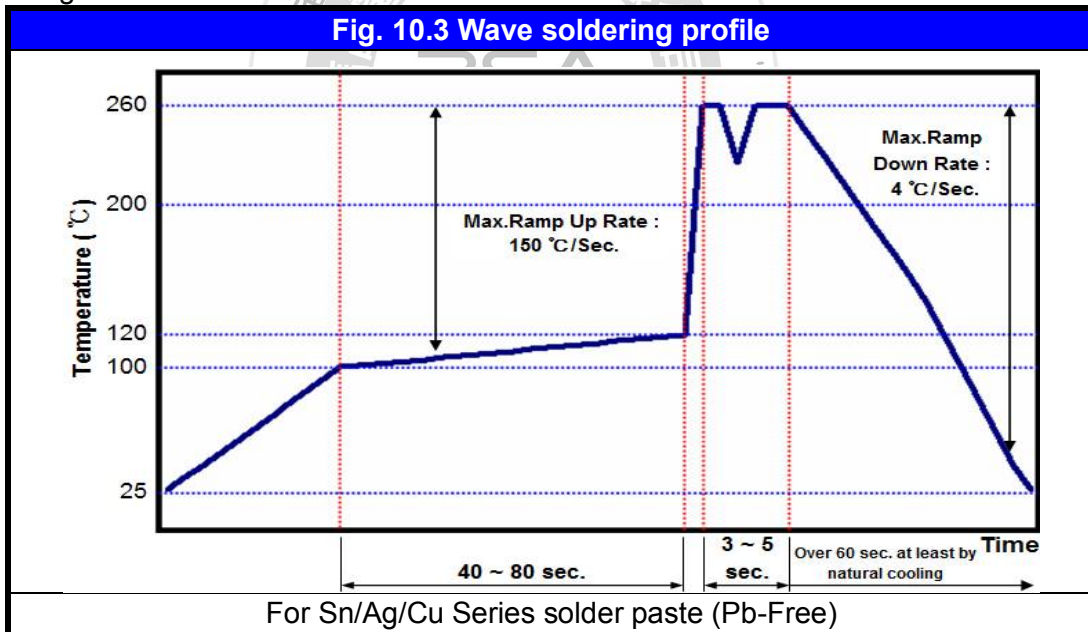

Soldering conditions :

Class I :

Size Inch (mm)	Temper. Cher.	Capacitance	Condition	
			Wave	Reflow
≤0402 (1005)	Class I	All	X	O
0603 (1608)	Class I	All	O	O
0805 (2012)	Class I	All	O	O
1206 (3216)	Class I	All	O	O
		Thickness >0.95mm	X	O
≥1210 (3225)	Class I	All	X	O
Coating Products	All	All	X	O

10. APPLICATION NOTES

Soldering conditions :

Class II :

Size Inch (mm)	Temper. Cher.	Capacitance	Condition	
			Wave	Reflow
≤0402 (1005)	Class II	All	X	O
0603 (1608)	Class II	Cap. <2.2μF	O	O
		Cap. ≥2.2μF	X	O
0805 (2012)	Class II	Thickness ≤ 0.95mm	O	O
		Thickness > 0.95mm	X	O
1206 (3216)	Class II	Thickness ≤ 0.95mm	O	O
		Thickness > 0.95mm	X	O
≥1210 (3225)	Class II	All	X	O
Coating Products	All	All	X	O

Soldering height :

The solder climbing minimum height is suggesting to 25% of chip thickness or 500um whichever is less.
(Reference from IPC-610E)

The diagram illustrates a cross-section of a chip on a substrate. A yellow chip is mounted on a grey substrate. A vertical double-headed arrow on the left indicates the 'Chip Thickness'. A vertical double-headed arrow on the right indicates the 'Soldering Height', which is the height of the solder joint between the chip and the substrate.

COOLING

After soldering, cool the chips and the substrate gradually to room temperature. Natural cooling in air is recommended to minimize stress in the solder joint.

CLEANING

All flux residues must be removed by using suitable electronic-grade vapor-cleaning solvents to eliminate contamination that could cause electrolytic surface corrosion. Good results can be obtained by using ultrasonic cleaning of the solvent. The choice of the proper system is depends upon many factors such as component mix, flux, and solder paste and assembly method. The ability of the cleaning system to remove flux residues and contamination from under the chips is very important.

X-ON Electronics

Largest Supplier of Electrical and Electronic Components

Click to view similar products for [Multilayer Ceramic Capacitors MLCC - SMD/SMT](#) category:

Click to view products by [Prosperity](#) manufacturer:

Other Similar products are found below :

[M39014/02-1218V](#) [M39014/02-1225V](#) [M39014/22-0631](#) [D55342E07B523DR-T/R](#) [NCA1206X7R103K50TRPF](#) [NCA1206X7R104K16TRPF](#)
[NIN-FC2R7JTRF](#) [NMC0402NPO220J50TRPF](#) [NMC0402X5R105K6.3TRPF](#) [NMC0402X5R224K6.3TRPF](#) [NMC0402X7R103J25TRPF](#)
[NMC0402X7R392K50TRPF](#) [NMC0603NPO201J50TRPF](#) [NMC0603X7R333K16TRPF](#) [NMC0805NPO820J50TRPF](#)
[NMC0805X7R224K16TRPLPF](#) [NMC1206X7R102K50TRPF](#) [NMC1206X7R106K10TRPLPF](#) [NMC1206X7R475K10TRPLPF](#)
[C1608C0G2A221J](#) [C1608X7R1E334K](#) [C2012C0G2A472J](#) [2220J2K00562KXT](#) [CDR33BX104AKUR](#) [CDR33BX683AKUS](#)
[CGA3E1X7R1C684K](#) [CL10C0R8BB8ANNC](#) [C1005X5R0G225M](#) [C2012X7R2E223K](#) [C3216C0G2J272J](#) [D55342E07B35E7R-T/R](#)
[NMC0402NPO150G50TRPF](#) [NMC0402NPO560F50TRPF](#) [NMC0402X7R562J25TRPF](#) [NMC0603NPO102J25TRPF](#)
[NMC1206X7R332K50TRPF](#) [726632-1](#) [CGA6M3X7R1H225K](#) [CGA5L2X7R2A105K](#) [CGA3E2X8R1H223K](#) [CDR33BX823AKUR\M500](#)
[CDR35BX474AKUR\M500](#) [CDR35BX104BKUR\M500](#) [69995D](#) [NMC0201X5R473K6.3TRPF](#) [NMC0201X7R221K25TRPF](#)
[NMC0402X5R105K10TRPF](#) [NMC0402X5R224K10TRPF](#) [NMC0603X7R104J25TRPF](#) [NMC0603X7R223K25TRPF](#)