

Prosperity Dielectrics Co., Ltd.

No.566-1, Kaoshi Rd., Yangmei, Taoyuan 32668, Taiwan (R.O.C.)

Tel : 886-3-4753355

Fax : 886-3-4854959

Messrs. : 一般共用

Date : 2021/06/11

APPROVAL SHEET

Product Name : High Voltage Multilayer Ceramic Chip Capacitors

Part No. : FV Series

Description : Size 0805~2225, C0G/X7R, 1000V~4000V

| PREPARED BY | APPROVED BY |
|-------------|-------------|
| | |

信昌電子陶瓷股份有限公司

PROSPERITY DIELECTRICS CO., LTD.

桃園市楊梅區高獅路 566-1 號 <http://www.pdc.com.tw>

Tel : 03-4753355 ext :

Fax : 03-4854959

Contactor : _____ **Mobile :** _____

Prosperity Dielectrics Co., Ltd.

No.566-1, Kaoshi Rd., Yangmei, Taoyuan 32668, Taiwan (R.O.C.)

Tel : 886-3-4753355

Fax : 886-3-4854959

SPECIFICATION

FOR

Product Name : High Voltage Multilayer Ceramic Chip Capacitors

Part No. : FV Series

Description : Size 0805~2225, C0G/X7R, 1000V~4000V

SPEC. No. : FV-000-001-22

DATE : 2021/06/11

| DRAWN BY | CHECEKED BY | APPROVED BY |
|-------------------|-------------------|--------------------|
| <i>Jane Hsiao</i> | <i>Yvens Chou</i> | <i>Joseph Ling</i> |

1. INTRODUCTION

PDC FV Series green type capacitors are manufactured by using environmental friendly material without lead or cadmium. These capacitors feature series connection of multi-layer capacitor units in a MLCC to realize high voltage performance. This special design can distribute voltage gradients throughout the entire capacitor, so as to prevent short circuit failure. It is a safety design for LCD back-lighting inverter application.

2. FEATURES

- Special interior design offers high voltage rating in a given case size.
- High reliability and stability.
- RoHS & HALOGEN compliant.

3. APPLICATIONS

- DC to DC converter.
- High voltage coupling/DC blocking.
- Back-lighting inverters.
- LAN/WLAN interface.
- Modem.
- Power supplies.

4. HOW TO ORDER

| FV | 31 | X | 103 | K | 102 | E | E | G |
|------------|-----------|------------|-------------|-----------|---------------|-----------|-----------|--------------|
| PDC Family | Size | Dielectric | Capacitance | Tolerance | Rated Voltage | Packaging | Thickness | Control Code |
| Table 1 | Table 2 | Table 3 | Table 4 | Table 5 | Table 6 | Table 7 | Table 8 | Table 9 |

| Table 1 PDC Family | |
|--------------------|---|
| Code | Description |
| FV | High voltage application with $\geq 1\text{KVdc}$ |

| Table 2 Size | | | | | |
|--------------|-------------|------|-------------|------|-------------|
| Code | Description | Code | Description | Code | Description |
| 15 | 0402 (1005) | 32 | 1210 (3225) | 52 | 2211 (5728) |
| 18 | 0603 (1608) | 42 | 1808 (4520) | 55 | 2220 (5750) |
| 21 | 0805 (2012) | 43 | 1812 (4532) | 56 | 2225 (5763) |
| 31 | 1206 (3216) | 46 | 1825 (4563) | | |

| Table 3 Dielectric Material Characteristics | | | |
|---|-------------|------|-------------|
| Code | Description | Code | Description |
| N | C0G | X | X7R |

| Table 4 Capacitance Rule Code | | | |
|-------------------------------|----------------------------------|------|------------------------------------|
| Code | Description | Code | Description |
| R47 | 0.47pF | 102 | $102=10 \times 10^2=1000\text{pF}$ |
| 0R5 | 0.5pF | 104 | $104=10 \times 10^4=100\text{nF}$ |
| 100 | $100=10 \times 10^0=10\text{pF}$ | 106 | $106=10 \times 10^6=10\mu\text{F}$ |

| Table 5 Tolerance | | | | | |
|-------------------|----------------------|------|----------------------|------|-------------|
| Code | Description | Code | Description | Code | Description |
| A | $\pm 0.05\text{ pF}$ | J | $\pm 5\%$ | | |
| B | $\pm 0.10\text{ pF}$ | K | $\pm 10\%$ | | |
| C | $\pm 0.25\text{ pF}$ | L | 0% ~ +10% | | |
| D | $\pm 0.50\text{ pF}$ | M | $\pm 20\%$ | | |
| F | $\pm 1\%$ | N | -5% ~ +10% | | |
| G | $\pm 2\%$ | P | $\pm 0.02\text{ pF}$ | | |
| H | $\pm 3\%$ | Q | $\pm 0.03\text{ pF}$ | | |
| I | -10% ~ 0% | Z | -20% ~ +80% | | |

| Table 6 Rated Voltage | | | | | |
|-----------------------|-------------|------|-------------|------|-------------|
| Code | Description | Code | Description | Code | Description |
| 102 | 1000Vdc | 252 | 2500Vdc | 502 | 5000Vdc |
| 152 | 1500Vdc | 302 | 3000Vdc | 602 | 6000Vdc |
| 202 | 2000Vdc | 402 | 4000Vdc | | |

| Table 7 Packaging Type | | | |
|------------------------|----------------------------------|------|-------------------------------|
| Code | Description | Code | Description |
| B | Bulk | T | Tray package |
| E | Tape and 7" Reel, Embossed Tape | P | Tape and 7" Reel, Paper Tape |
| K | Tape and 10" Reel, Embossed Tape | D | Tape and 10" Reel, Paper Tape |
| L | Tape and 13" Reel, Embossed Tape | G | Tape and 13" Reel, Paper Tape |

| Table 8 Thickness Description | | | | | |
|-------------------------------|----------------------------|------|----------------------------|------|------------------------------|
| Code | Description | Code | Description | Code | Description |
| A | $0.60 \pm 0.10\text{ mm}$ | I | $1.25 \pm 0.20\text{ mm}$ | Q | $0.50 +0.02/-0.05\text{ mm}$ |
| B | $0.8+0.15/-0.10\text{ mm}$ | J | $1.15 \pm 0.15\text{ mm}$ | R | $3.10 \pm 0.30\text{ mm}$ |
| C | $1.25 \pm 0.10\text{ mm}$ | K | $0.50 \pm 0.20\text{ mm}$ | S | $0.80 \pm 0.07\text{ mm}$ |
| D | $1.40 \pm 0.15\text{ mm}$ | L | $0.30 \pm 0.03\text{ mm}$ | T | $0.85 \pm 0.10\text{ mm}$ |
| E | $1.60 \pm 0.20\text{ mm}$ | M | $0.95 \pm 0.10\text{ mm}$ | U | $0.50 \pm 0.10\text{ mm}$ |
| F | $2.00 \pm 0.20\text{ mm}$ | N | $0.50 \pm 0.05\text{ mm}$ | V | $0.20 \pm 0.02\text{ mm}$ |
| G | $2.50 \pm 0.30\text{ mm}$ | O | $3.50 \pm 0.20\text{ mm}$ | X | $0.80 \pm 0.10\text{ mm}$ |
| H | $2.80 \pm 0.30\text{ mm}$ | P | $1.60+0.3/-0.10\text{ mm}$ | Z | $0.25 \pm 0.03\text{ mm}$ |

| Table 9 Special Control Code | |
|------------------------------|----------------------------------|
| Code | Description |
| G | RoHS compliant |
| Q | Surface Coating (Size 1206~2225) |

5. EXTERNAL DIMENSIONS

| Size Inch (mm) | L (mm) | W (mm) | Code / T (mm) | M _B (mm) |  |
|----------------|------------------|------------------------------|----------------------------|---------------------|---|
| 0805(2012) | 2.10±0.20 | 1.25±0.20 | See No.4 Reference Table 8 | 0.50±0.20 | |
| 1206(3216) | 3.30±0.30 | 1.60±0.20 1.60 +0.3/-0.1* | | 0.60±0.20 | |
| 1210(3225) | 3.30±0.40 | 2.50±0.30 | | 0.75±0.35 | |
| 1808(4520) | 4.50 +0.50/-0.30 | 2.00±0.25 | | 0.75±0.35 | |
| 1812(4532) | 4.50 +0.50/-0.30 | 3.20±0.40 | | 0.75±0.35 | |
| 1825(4563) | 4.50 +0.50/-0.30 | 6.30±0.40 | | 0.75±0.35 | |
| 2211(5728) | 5.70±0.40 | 2.80±0.30 | | 0.85±0.35 | |
| 2220(5750) | 5.70±0.40 | 5.00±0.40 | | 0.85±0.35 | |
| 2225(5763) | 5.70±0.40 | 6.30±0.40 | | 0.85±0.35 | |

Fig. 5.1 The outline of MLCC

* for 1206 P thickness products.

6. GENERAL ELECTRICAL DATA

| Dielectric | C0G | X7R |
|---|--|--|
| Size | 0805, 1206, 1210, 1808, 1812, 1825, 2220, 2225 | 0805, 1206, 1210, 1808, 1812, 1825, 2211, 2220, 2225 |
| Rated voltage (WVDC) | 1000V, 1500V, 2000V, 3000V, 4000V | 1000V, 1500V, 2000V, 3000V, 4000V |
| Capacitance range | 1.5pF ~ 10nF | 100pF ~ 220nF |
| Capacitance tolerance | Reference to Table 5 | Reference to Table 5 |
| Tan δ | Cap. Rang | Q Spec. |
| | Cap.<30pF | Q≥400+20C |
| | Cap.≥30pF | Q≥1000 |
| Capacitance & Tan δ Test condition | Measured at the condition of 30~70% related humidity | |
| | For 25°C at ambient temperature | Preconditioning for Class II MLCC : Perform a heat treatment at 150±10°C for 1 hour, then leave in ambient condition for 24±2 hours before measurement |
| | Cap. Rang | Test Condition |
| Insulation resistance at U _r | ≥10GΩ or RxC≥500Ω-F, whichever is smaller | |
| | ≥10GΩ or RxC≥100Ω-F, whichever is smaller | |
| | -55°C to +125°C | |
| Operating temperature | | |
| Capacitance characteristic | ±30ppm/°C | ±15% |
| Termination | Cu or Ag/Ni/Sn or Au (lead-free termination) | |

7. CAPACITANCE RANGE

7-1. C0G

| Dimension | | 0805 | 1206 | | | | 1210 | | | |
|-----------|------|-------|-------|-------|-------|-------|-------|-------|-------|-------|
| Cap.(pF) | Code | 1000V | 1000V | 1500V | 2000V | 3000V | 1000V | 1500V | 2000V | 3000V |
| 1.5 | 1R5 | C | X | X | X | | | | | |
| 1.8 | 1R8 | C | X | X | X | | | | | |
| 2.2 | 2R2 | C | X | X | X | | | | | |
| 2.7 | 2R7 | C | X | X | X | | | | | |
| 3.3 | 3R3 | C | X | X | X | | | | | |
| 3.9 | 3R9 | C | X | X | X | | | | | |
| 4.7 | 4R7 | C | X | X | X | | | | | |
| 5.0 | 5R0 | C | X | X | X | | | | | |
| 5.6 | 5R6 | C | X | X | X | | | | | |
| 6.8 | 6R8 | C | X | X | X | | | | | |
| 8.2 | 8R2 | C | X | X | X | | | | | |
| 10 | 100 | C | X | X | X | E | M | M | M | F |
| 12 | 120 | C | X | X | X | E | M | M | M | F |
| 15 | 150 | C | X | X | X | E | M | M | M | F |
| 18 | 180 | C | X | X | X | E | M | M | M | F |
| 22 | 220 | C | X | X | X | E | M | M | M | F |
| 27 | 270 | C | X | X | X | E | M | M | M | F |
| 33 | 330 | C | X | M | M | E | M | M | M | F |
| 39 | 390 | C | X | M | M | E | M | M | M | F |
| 47 | 470 | C | X | M | M | E | M | M | M | F |
| 56 | 560 | C | X | C | C | E | M | C | C | F |
| 68 | 680 | C | X | C | C | E | M | C | C | F |
| 82 | 820 | C | X | C | C | E | M | C | C | F |
| 100 | 101 | C | X | C | C | E | C | C | C | F |
| 120 | 121 | C | X/C | E | E | E | C | C | C | F |
| 150 | 151 | C | C | E | E | | C | E | E | F |
| 180 | 181 | C | E/C | E | E | | C | E | E | F |
| 220 | 221 | C | E/C | E | E | | E | E | E | F |
| 270 | 271 | C | E/C | P | P | | E | F | F | G |
| 330 | 331 | C | E/C | P/E | P/E | | E | F | F | |
| 390 | 391 | C | E/C | P/E | P/E | | E | G | G | |
| 470 | 471 | | E/C | E | E | | E | C | C | |
| 560 | 561 | | E | | | | E | G | G | |
| 680 | 681 | | E | | | | E | G | G | |
| 820 | 821 | | E | | | | E | G | G | |
| 1000 | 102 | | E | | | | E | G | G | |
| 1200 | 122 | | | | | | E | F | F | |
| 1500 | 152 | | | | | | F | G | G | |
| 1800 | 182 | | | | | | G | G | G | |
| 2200 | 222 | | | | | | G | | | |
| 2700 | 272 | | | | | | G | | | |
| 3300 | 332 | | | | | | G | | | |
| 3900 | 392 | | | | | | G | | | |

7. CAPACITANCE RANGE(Con.)

7-1. C0G

| Dimension | | 1808 | | | | | 1812 | | | | | 1825 | | | |
|-----------|------|-------|-------|-------|-------|-------|-------|-------|-------|-------|-------|-------|-------|-------|-------|
| Cap.(pF) | Code | 1000V | 1500V | 2000V | 3000V | 4000V | 1000V | 1500V | 2000V | 3000V | 4000V | 1000V | 1500V | 2000V | 3000V |
| 1.5 | 1R5 | | | | | | | | | | | | | | |
| 1.8 | 1R8 | | | | | | | | | | | | | | |
| 2.2 | 2R2 | C | C | C | C | C | | | | | | | | | |
| 2.7 | 2R7 | C | C | C | C | C | | | | | | | | | |
| 3.3 | 3R3 | C | C | C | C | C | | | | | | | | | |
| 3.9 | 3R9 | C | C | C | C | C | | | | | | | | | |
| 4.7 | 4R7 | C | C | C | C | C | | | | | | | | | |
| 5.0 | 5R0 | C | C | C | C | C | | | | | | | | | |
| 5.6 | 5R6 | C | C | C | C | C | | | | | | | | | |
| 6.8 | 6R8 | C | C | C | C | C | | | | | | | | | |
| 8.2 | 8R2 | C | C | C | C | C | | | | | | | | | |
| 10 | 100 | C | C | C | C | C | C | C | C | C | C | F | F | F | F |
| 12 | 120 | C | C | C | C | C | C | C | C | C | C | F | F | F | F |
| 15 | 150 | C | C | C | C | C | C | C | C | C | C | F | F | F | F |
| 18 | 180 | C | C | C | C | C | C | C | C | C | C | F | F | F | F |
| 22 | 220 | C | C | C | C | E | C | C | C | C | C | F | F | F | F |
| 27 | 270 | C | C | C | C | E | C | C | C | C | C | F | F | F | F |
| 33 | 330 | C | C | C | C | E* | C | C | C | C | C | F | F | F | F |
| 39 | 390 | C | C | C | C | F* | C | C | C | C | C* | F | F | F | F |
| 47 | 470 | C | C | C | C | G | C | C | C | C | C* | F | F | F | F |
| 56 | 560 | C | C | C | C | G | C | C | C | C | E* | F | F | F | F |
| 68 | 680 | C | C | C | C | G | C | C | C | C | E* | F | F | F | F |
| 82 | 820 | C | C | C | C | G | C | C | C | C | F* | F | F | F | F |
| 100 | 101 | C | C | C | F | G | C | C | C | C | F* | F | F | F | F |
| 120 | 121 | C | C | C | F | G | C | C | C | C | G* | F | F | F | F |
| 150 | 151 | C | F | F | F | G | C | C | C | C | | F | F | F | F |
| 180 | 181 | C | F | F | F | G | C | C | C | F | | F | F | F | F |
| 220 | 221 | C | F | F | F | G | C | C | C | F | | F | F | F | F |
| 270 | 271 | F | F | F | F | G | C | F | F | F | | F | F | F | F |
| 330 | 331 | F | F | F | F | G | C | F | F | F | | F | F | F | F |
| 390 | 391 | F | F | F | F | G | C | F | F | F | | F | F | F | F |
| 470 | 471 | F | F | F | F | G | F | F | F | F | | F | F | F | F |
| 560 | 561 | F | F | F | F | G | F | F | F | F | | F | F | F | F |
| 680 | 681 | F | F | F | F | G | F | F | F | F | | F | F | F | F |
| 820 | 821 | F | F | F | F | G | F | F | F | G | | F | F | F | F |
| 1000 | 102 | F | F | F | F | G | F | F | F | G | | F | F | F | F |
| 1200 | 122 | F | F | F | F | G | F | F | F | R | | F | F | F | |
| 1500 | 152 | F | F | F | F | G | F | F | F | | | F | F | F | |
| 1800 | 182 | F | F | F | F | G | E | F | F | | | F | F | F | |
| 2200 | 222 | F | F | F | F | G | E | F | F | | | F | F | F | |
| 2700 | 272 | | | | | G | F | G | G | | | F | F | F | |
| 3300 | 332 | | | | | G | F | G | G | | | F | F | F | |
| 3900 | 392 | | | | | G | G | | | | | F | F | F | |
| 4700 | 472 | | | | | G | G | | | | | F | F | F | |
| 5600 | 562 | | | | | G | G | | | | | F | | | |
| 6800 | 682 | | | | | G | G | | | | | F | | | |
| 8200 | 822 | | | | | G | G | | | | | G | | | |
| 10000 | 103 | | | | | G | G | | | | | G | | | |
| 12000 | 123 | | | | | G | G | | | | | G | | | |

7. CAPACITANCE RANGE(Con.)

7-1. C0G

| Dimension | | 2220 | | | | | 2225 | | | | |
|-----------|------|-------|-------|-------|-------|-------|-------|-------|-------|-------|-------|
| Cap.(pF) | Code | 1000V | 1500V | 2000V | 3000V | 4000V | 1000V | 1500V | 2000V | 3000V | 4000V |
| 1.5 | 1R5 | | | | | | | | | | |
| 1.8 | 1R8 | | | | | | | | | | |
| 2.2 | 2R2 | | | | | | | | | | |
| 2.7 | 2R7 | | | | | | | | | | |
| 3.3 | 3R3 | | | | | | | | | | |
| 3.9 | 3R9 | | | | | | | | | | |
| 4.7 | 4R7 | | | | | | | | | | |
| 5.0 | 5R0 | | | | | | | | | | |
| 5.6 | 5R6 | | | | | | | | | | |
| 6.8 | 6R8 | | | | | | | | | | |
| 8.2 | 8R2 | | | | | | | | | | |
| 10 | 100 | F | F | F | F | F | F | F | F | F | F |
| 12 | 120 | F | F | F | F | F | F | F | F | F | F |
| 15 | 150 | F | F | F | F | F | F | F | F | F | F |
| 18 | 180 | F | F | F | F | F | F | F | F | F | F |
| 22 | 220 | F | F | F | F | F | F | F | F | F | F |
| 27 | 270 | F | F | F | F | F | F | F | F | F | F |
| 33 | 330 | F | F | F | F | F | F | F | F | F | F |
| 39 | 390 | F | F | F | F | F | F | F | F | F | F |
| 47 | 470 | F | F | F | F | F | F | F | F | F | F |
| 56 | 560 | F | F | F | F | F | F | F | F | F | F |
| 68 | 680 | F | F | F | F | F | F | F | F | F | F |
| 82 | 820 | F | F | F | F | F | F | F | F | F | F |
| 100 | 101 | F | F | F | F | F | F | F | F | F | F |
| 120 | 121 | F | F | F | F | F | F | F | F | F | |
| 150 | 151 | F | F | F | F | F | F | F | F | F | |
| 180 | 181 | F | F | F | F | F | F | F | F | F | |
| 220 | 221 | F | F | F | F | F | F | F | F | F | |
| 270 | 271 | F | F | F | F | G | F | F | F | F | |
| 330 | 331 | F | F | F | F | G | F | F | F | F | |
| 390 | 391 | F | F | F | F | | F | F | F | F | |
| 470 | 471 | F | F | F | F | | F | F | F | F | |
| 560 | 561 | F | F | F | F | | F | F | F | F | |
| 680 | 681 | F | F | F | F | | F | F | F | F | |
| 820 | 821 | F | F | F | F | | F | F | F | F | |
| 1000 | 102 | F | F | F | F | | F | F | F | F | |
| 1200 | 122 | F | F | F | F | | F | F | F | F | |
| 1500 | 152 | F | F | F | F | | F | F | F | F | |
| 1800 | 182 | F | F | F | | | F | F | F | F | |
| 2200 | 222 | F | F | F | | | F | F | F | F | |
| 2700 | 272 | F | F | F | | | F | F | F | G | |
| 3300 | 332 | F | F | F | | | F | F | F | G | |
| 3900 | 392 | F | F | F | | | F | F | F | | |
| 4700 | 472 | F | F | F | | | F | F | F | | |
| 5600 | 562 | F | | | | | F | F | F | | |
| 6800 | 682 | F | | | | | F | F | F | | |
| 8200 | 822 | G | | | | | F | G | G | | |
| 10000 | 103 | G | | | | | G | G | G | | |
| 12000 | 123 | | | | | | | | | | |

PSA 信昌電子陶瓷股份有限公司
Prosperity Dielectrics Co., Ltd.

7. CAPACITANCE RANGE(Con.)

7-2. X7R

| Dimension | | 0805 | 1206 | | | | 1210 | | | 1808 | | | | |
|-----------|------|-------|-------|-------|-------|-------|-------|-------|-------|-------|-------|-------|-------|-------|
| Cap.(pF) | Code | 1000V | 1000V | 1500V | 2000V | 2500V | 1000V | 1500V | 2000V | 1000V | 1500V | 2000V | 3000V | 4000V |
| 100 | 101 | X | C | C | C | C | C | C | C | | | | | |
| 120 | 121 | X | C | C | C | C | C | C | C | | | | | |
| 150 | 151 | X | C | C | C | C | C | C | C | C | C | C | C | F* |
| 180 | 181 | X | C | C | C | C | C | C | C | C | C | C | C | F* |
| 220 | 221 | X | C | C | C | C | C | C | C/E | C | C | C | C | F* |
| 270 | 271 | X | C | C | C | C | C | C | C/E | C | C | C | C | F* |
| 330 | 331 | X | C | C | C | C | C | C | C/E | C | C | C | F | F* |
| 390 | 391 | X | C | C | C | C | C | C | C/E | C | C | C | F | F* |
| 470 | 471 | X | C | C | C | C | C | C | C/E | C | C | C | F | F* |
| 560 | 561 | X | C | C | C | C | C | C | C/E | C | C | C | F | F* |
| 680 | 681 | X | C | C | C | C* | C | C | C/E | C | C | C | F | F* |
| 820 | 821 | X | C | C | C | C* | C | C | C/E | C | C | C | F | F* |
| 1000 | 102 | X | C | C | C | C* | C | C | C/E | C | C | C/E | F | F* |
| 1200 | 122 | X | C | E | E | E* | C | G | C/E | C | F | F | F | |
| 1500 | 152 | C | C | E | E | E* | C | G | F | C | F | F | F | |
| 1800 | 182 | C | C | E | E | E* | C | G | F | C | F | F | F | |
| 2200 | 222 | C | C | E | E | E* | C | G | F | C | F | F | F | |
| 2700 | 272 | C | C | E | E | E* | C | G | G | C | F | F | F | |
| 3300 | 332 | C | C | E | E | E* | C | G | G | C | F | F | F | |
| 3900 | 392 | C | C | E | | E* | E | G | G | C | F | F | | |
| 4700 | 472 | C | C | E | | E* | E | G/F | G/F | C | F | F | | |
| 5600 | 562 | | C | E | | | E | G | G* | F | F | F | | |
| 6800 | 682 | | C | E | | | E | G | G* | F | F | F | | |
| 8200 | 822 | | C | E | | | E | G | G* | F | F* | | | |
| 10000 | 103 | | C | E | | | E | G | | F | F* | | | |
| 12000 | 123 | | E | | | | E | G | | F | | | | |
| 15000 | 153 | | E | | | | E | G | | F | | | | |
| 18000 | 183 | | E | | | | E | G | | F | | | | |
| 22000 | 223 | | E | | | | E | G | | F | | | | |
| 27000 | 273 | | | | | | E | G | | F | | | | |
| 33000 | 333 | | | | | | E | G | | F | | | | |
| 39000 | 393 | | | | | | F | | | F | | | | |
| 47000 | 473 | | | | | | G | | | F | | | | |
| 56000 | 563 | | | | | | | | | F | | | | |
| 68000 | 683 | | | | | | | | | | | | | |

* Surface coating only.

Prosperity Dielectrics Co., Ltd.

7. CAPACITANCE RANGE(Con.)

7-2. X7R

| Dimension | | 1812 | | | | | 1825 | | | | |
|-----------|------|-------|-------|-------|-------|-------|-------|-------|-------|-------|-------|
| Cap.(pF) | Code | 1000V | 1500V | 2000V | 3000V | 4000V | 1000V | 1500V | 2000V | 3000V | 4000V |
| 270 | 271 | C | C | C | F | F* | | | | | F* |
| 330 | 331 | C | C | C | F | F* | | | | | F* |
| 390 | 391 | C | C | C | F | F* | | | | | F* |
| 470 | 471 | C | C | C | F | F* | | | | | F* |
| 560 | 561 | C | C | C | F | F* | | | | | F* |
| 680 | 681 | C | C | C | F | F* | | | | | F* |
| 820 | 821 | C | C | C | F | F* | | | | | F* |
| 1000 | 102 | C | C | C | F | F* | F | F | F | F | F* |
| 1200 | 122 | C | C | C | F | G* | F | F | F | F | G* |
| 1500 | 152 | C | C | C | F | G* | F | F | F | F | G* |
| 1800 | 182 | C | C | C | G | G* | F | F | F | F | G* |
| 2200 | 222 | C | C | C | G* | | F | F | F | F* | |
| 2700 | 272 | C | C | C | G* | | F | F | F | F* | |
| 3300 | 332 | C | F | F | G* | | F | F | F | F* | |
| 3900 | 392 | C | F | F | G* | | F | F | F | F* | |
| 4700 | 472 | C | F | F | G* | | F | F | F | F* | |
| 5600 | 562 | C | G | G | | | F | F | F | G* | |
| 6800 | 682 | C | G | G | | | F | F | F | G* | |
| 8200 | 822 | C | G | G | | | F | F | F | G* | |
| 10000 | 103 | C | G/F | G/F | | | F | F | F | G* | |
| 12000 | 123 | F | | | | | F | G | G | H* | |
| 15000 | 153 | F | | | | | F | G | G | H* | |
| 18000 | 183 | G | | | | | F | G | G | H* | |
| 22000 | 223 | G | | | | | F | G | G | | |
| 27000 | 273 | G | | | | | F | H | H | | |
| 33000 | 333 | G | | | | | F | H | H | | |
| 39000 | 393 | G | | | | | F | H | H | | |
| 47000 | 473 | G/F | | | | | F | H | H | | |
| 56000 | 563 | G | | | | | F | H | | | |
| 68000 | 683 | G | | | | | F | | | | |
| 82000 | 823 | G | | | | | F | | | | |
| 100000 | 104 | G | | | | | G | | | | |
| 120000 | 124 | | | | | | | | | | |
| 150000 | 154 | | | | | | | | | | |
| 180000 | 184 | | | | | | | | | | |
| 220000 | 224 | | | | | | | | | | |
| 270000 | 274 | | | | | | | | | | |
| 330000 | 334 | | | | | | | | | | |

* Surface coating only.

Prosperity Dielectrics Co., Ltd.

7. CAPACITANCE RANGE(Con.)

7-2. X7R

| Dimension | | 2211 | | 2220 | | | | | 2225 | | | | |
|-----------|------|-------|-------|-------|-------|-------|-------|-------|-------|-------|-------|-------|-------|
| Cap.(pF) | Code | 3000V | 4000V | 1000V | 1500V | 2000V | 3000V | 4000V | 1000V | 1500V | 2000V | 3000V | 4000V |
| 270 | 271 | F | F* | | | | | F* | | | | | F* |
| 330 | 331 | F | F* | | | | | F* | | | | | F* |
| 390 | 391 | F | F* | | | | | F* | | | | | F* |
| 470 | 471 | F | F* | | | | | F* | | | | | F* |
| 560 | 561 | F | F* | | | | | F* | | | | | F* |
| 680 | 681 | F | F* | | | | | F* | | | | | F* |
| 820 | 821 | F | F* | | | | | F* | | | | | F* |
| 1000 | 102 | F | F* | F | F | F | F | F* | F | F | F | F | F* |
| 1200 | 122 | G | G* | F | F | F | F | G* | F | F | F | F | G* |
| 1500 | 152 | G | G* | F | F | F | F | G* | F | F | F | F | G* |
| 1800 | 182 | G | G* | F | F | F | F | G* | F | F | F | F | G* |
| 2200 | 222 | G | | F | F | F | F* | | F | F | F | F* | |
| 2700 | 272 | G | | F | F | F | F* | | F | F | F | F* | |
| 3300 | 332 | G | | F | F | F | F* | | F | F | F | F* | |
| 3900 | 392 | | | F | F | F | F* | | F | F | F | F* | |
| 4700 | 472 | | | F | F | F | F* | | F | F | F | F* | |
| 5600 | 562 | | | F | F | F | F* | | F | F | F | G* | |
| 6800 | 682 | | | F | F | F | G* | | F | F | F | G* | |
| 8200 | 822 | | | F | G | G | G* | | F | F | F | G* | |
| 10000 | 103 | | | F | G/F | G/F | G* | | F | F | F | G* | |
| 12000 | 123 | | | F | G | G | H* | | F | G | G | G* | |
| 15000 | 153 | | | F | G | G | H* | | F | G | G | G* | |
| 18000 | 183 | | | F | H | H | H* | | F | G | G | H* | |
| 22000 | 223 | | | F | H | H | | | F | G/F | G/F | | |
| 27000 | 273 | | | F | H | H | | | F | G | G | | |
| 33000 | 333 | | | F | H | H | | | F | G | G | | |
| 39000 | 393 | | | F | H | H | | | F | G | H | | |
| 47000 | 473 | | | F | H | H | | | F | G | H | | |
| 56000 | 563 | | | F | H | H | | | F | G | H | | |
| 68000 | 683 | | | F | | | | | F | G | | | |
| 82000 | 823 | | | F | | | | | F | G | | | |
| 100000 | 104 | | | G | | | | | G | G | | | |
| 120000 | 124 | | | G/F | | | | | H | | | | |
| 150000 | 154 | | | H | | | | | H | | | | |
| 180000 | 184 | | | H | | | | | H | | | | |
| 220000 | 224 | | | H | | | | | H | | | | |
| 270000 | 274 | | | | | | | | F/G/H | | | | |
| 330000 | 334 | | | | | | | | F/G/H | | | | |
| 390000 | 394 | | | | | | | | | | | | |

* Surface coating only.

Prosperity Dielectrics Co., Ltd.

8. RELIABILITY TEST CONDITIONS AND REQUIREMENTS

| No. | Item | Test Condition | Requirements | | | | | | | | | | | | | | | |
|----------------|---|--|---|-----------------|----------------|------------------------------------|----------------------------|-----------------------------|---|-----------------------------|---|-----------|---|----------------|---|------------|-----|---|
| 1. | Visual and Dimensions | --- | * No remarkable defect. * Dimensions to confirm to individual specification sheet. | | | | | | | | | | | | | | | |
| 2. | Capacitance | | * Shall not exceed the limits given in the detailed spec. | | | | | | | | | | | | | | | |
| 3. | Q/D.F. (Tangent of loss angle) | * Class I : C0G Cap. ≤1000pF, 1.0±0.2Vrms, 1MHz±10%. Cap. >1000pF, 1.0±0.2Vrms, 1KHz±10%. * Class II : X7R 1.0±0.2Vrms, 1KHz±10%. | <table border="1"> <thead> <tr> <th>Dielectric</th> <th>Rated Vol.(V)</th> <th>Q/D.F.</th> <th>Remark</th> </tr> </thead> <tbody> <tr> <td rowspan="2">Class I (C0G)</td> <td rowspan="2">All</td> <td>Q≥1000</td> <td>Cap. ≥30pF</td> </tr> <tr> <td>Q≥400+20C</td> <td>Cap. <30pF</td> </tr> <tr> <td>Class II (X7R)</td> <td>All</td> <td>D.F. ≤2.5%</td> <td></td> </tr> </tbody> </table> | Dielectric | Rated Vol.(V) | Q/D.F. | Remark | Class I (C0G) | All | Q≥1000 | Cap. ≥30pF | Q≥400+20C | Cap. <30pF | Class II (X7R) | All | D.F. ≤2.5% | | |
| Dielectric | Rated Vol.(V) | Q/D.F. | Remark | | | | | | | | | | | | | | | |
| Class I (C0G) | All | Q≥1000 | Cap. ≥30pF | | | | | | | | | | | | | | | |
| | | Q≥400+20C | Cap. <30pF | | | | | | | | | | | | | | | |
| Class II (X7R) | All | D.F. ≤2.5% | | | | | | | | | | | | | | | | |
| 4. | Temperature Coefficient (Temperature characteristic of capacitance) | * With no electrical load. <table border="1"> <thead> <tr> <th>T.C.</th> <th>Operating Temp.</th> </tr> </thead> <tbody> <tr> <td>C0G</td> <td>-55~125°C at 25°C</td> </tr> <tr> <td>X7R</td> <td>-55~125°C at 25°C</td> </tr> </tbody> </table> | T.C. | Operating Temp. | C0G | -55~125°C at 25°C | X7R | -55~125°C at 25°C | <table border="1"> <thead> <tr> <th>T.C.</th> <th>Capacitance Change</th> </tr> </thead> <tbody> <tr> <td>C0G</td> <td>Within ±30ppm/°C</td> </tr> <tr> <td>X7R</td> <td>Within ±15%</td> </tr> </tbody> </table> | T.C. | Capacitance Change | C0G | Within ±30ppm/°C | X7R | Within ±15% | | | |
| T.C. | Operating Temp. | | | | | | | | | | | | | | | | | |
| C0G | -55~125°C at 25°C | | | | | | | | | | | | | | | | | |
| X7R | -55~125°C at 25°C | | | | | | | | | | | | | | | | | |
| T.C. | Capacitance Change | | | | | | | | | | | | | | | | | |
| C0G | Within ±30ppm/°C | | | | | | | | | | | | | | | | | |
| X7R | Within ±15% | | | | | | | | | | | | | | | | | |
| 5. | Insulation Resistance | <table border="1"> <thead> <tr> <th>Rated Vol.(V)</th> <th>Apply Voltage</th> <th>Test Condition</th> </tr> </thead> <tbody> <tr> <td>>500</td> <td>500Vdc</td> <td>60 sec.</td> </tr> </tbody> </table> | Rated Vol.(V) | Apply Voltage | Test Condition | >500 | 500Vdc | 60 sec. | <table border="1"> <thead> <tr> <th>Dielectric</th> <th>Requirements</th> </tr> </thead> <tbody> <tr> <td>Class I</td> <td>≥10GΩ or RxC≥500Ω-F, whichever is smaller</td> </tr> <tr> <td>Class II</td> <td>≥10GΩ or RxC≥100Ω-F, whichever is smaller</td> </tr> </tbody> </table> | Dielectric | Requirements | Class I | ≥10GΩ or RxC≥500Ω-F, whichever is smaller | Class II | ≥10GΩ or RxC≥100Ω-F, whichever is smaller | | | |
| Rated Vol.(V) | Apply Voltage | Test Condition | | | | | | | | | | | | | | | | |
| >500 | 500Vdc | 60 sec. | | | | | | | | | | | | | | | | |
| Dielectric | Requirements | | | | | | | | | | | | | | | | | |
| Class I | ≥10GΩ or RxC≥500Ω-F, whichever is smaller | | | | | | | | | | | | | | | | | |
| Class II | ≥10GΩ or RxC≥100Ω-F, whichever is smaller | | | | | | | | | | | | | | | | | |
| 6. | Solderability | * Solder temperature : 235±5°C for (0603~1210). * Solder temperature : 245±5°C for (1808~2225). * Dipping time : 2±0.5 sec. | * 75% min. coverage of all metalized area. | | | | | | | | | | | | | | | |
| 7. | Dielectric Strength (Voltage proof) | <table border="1"> <thead> <tr> <th>Rated Vol.(V)</th> <th>Condition</th> </tr> </thead> <tbody> <tr> <td>630≤V≤3000V</td> <td>1.2 times of U_RSYSTEM</td> </tr> <tr> <td>3000<V<5000V</td> <td>1.1 times of U_R</td> </tr> <tr> <td>≥5000V</td> <td>1.0 times of U_R</td> </tr> </tbody> </table> <p>* Duration : 1 to 5 sec. * Voltage ramp up rate ≤500Vdc/sec. * Charge and discharge current less than 50mA. * Test in insulating fluid.</p> | Rated Vol.(V) | Condition | 630≤V≤3000V | 1.2 times of U _R SYSTEM | 3000<V<5000V | 1.1 times of U _R | ≥5000V | 1.0 times of U _R | * No evidence of damage or flashover during test. | | | | | | | |
| Rated Vol.(V) | Condition | | | | | | | | | | | | | | | | | |
| 630≤V≤3000V | 1.2 times of U _R SYSTEM | | | | | | | | | | | | | | | | | |
| 3000<V<5000V | 1.1 times of U _R | | | | | | | | | | | | | | | | | |
| ≥5000V | 1.0 times of U _R | | | | | | | | | | | | | | | | | |
| 8. | Resistance to Soldering Heat | * Solder temperature : 260±5°C. * Dipping time : 10±1 sec. * Preheating : 120 to 150°C for 1 minute before immerse the capacitor in a eutectic solder. * Before initial measurement (Class II only) : Perform 150 +0/-10°C for 1 hr and then set for 48±4 hrs at room temp. * Measurement to be made after keeping at room temp. for 24±2 hrs (Class I) or 48±4 hrs (Class II). | * No remarkable damage. * Cap. Change : C0G : Within ±2.5% or ±0.25pF, whichever is larger. X7R : Within ±7.5%. * Q/D.F. & I.R. : To meet the initial requirement. * 25% max. leaching on each edge. | | | | | | | | | | | | | | | |
| 9. | Temperature Cycle (Rapid change of temperature) | * Conduct the five cycles according to the temperatures and time. <table border="1"> <thead> <tr> <th>Step</th> <th>Temp.(°C)</th> <th>Time(min.)</th> </tr> </thead> <tbody> <tr> <td>1</td> <td>Min. operating temp. +0/-3</td> <td>30±3</td> </tr> <tr> <td>2</td> <td>Room temp.</td> <td>2~3</td> </tr> <tr> <td>3</td> <td>Max. operating temp. +3/-0</td> <td>30±3</td> </tr> <tr> <td>4</td> <td>Room temp.</td> <td>2~3</td> </tr> </tbody> </table> <p>* Before initial measurement (Class II only) : Perform 150 +0/-10°C for 1 hr and then set for 48±4 hrs at room temp. * Measurement to be made after keeping at room temp. for 24±2 hrs (Class I) or 48±4 hrs (Class II).</p> | Step | Temp.(°C) | Time(min.) | 1 | Min. operating temp. +0/-3 | 30±3 | 2 | Room temp. | 2~3 | 3 | Max. operating temp. +3/-0 | 30±3 | 4 | Room temp. | 2~3 | * No remarkable damage. * Cap. change : C0G : Within ±2.5% or ±0.25pF, whichever is larger. X7R : Within ±7.5%. * Q/D.F. : C0G : To meet the initial requirement. X7R : D.F. ≤150% of initial requirement. * I.R. : To meet the initial requirement. |
| Step | Temp.(°C) | Time(min.) | | | | | | | | | | | | | | | | |
| 1 | Min. operating temp. +0/-3 | 30±3 | | | | | | | | | | | | | | | | |
| 2 | Room temp. | 2~3 | | | | | | | | | | | | | | | | |
| 3 | Max. operating temp. +3/-0 | 30±3 | | | | | | | | | | | | | | | | |
| 4 | Room temp. | 2~3 | | | | | | | | | | | | | | | | |

Prosperity Dielectrics Co., Ltd.

8. RELIABILITY TEST CONDITIONS AND REQUIREMENTS

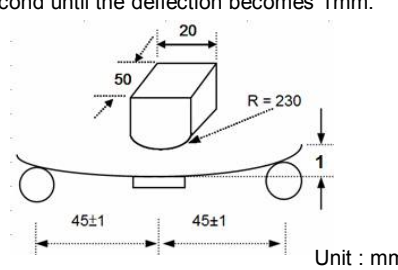
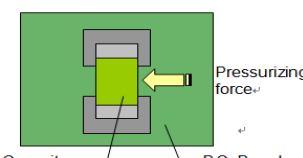
| No. | Item | Test Condition | Requirements | | | | | | |
|----------------|--|--|--|------------|-------------|---------------|---|----------------|---------------|
| 10. | Humidity (Damp Heat) Steady State | * Test temp. : 40±2°C. * Humidity : 90~95%RH. * Test time : 500 +24/-0 hrs. * Measurement to be made after keeping at room temp. for 24±2 hrs (Class I) or 48±4 hrs (Class II). | * No remarkable damage. * Cap. change : C0G : Within ±5.0% or ±0.5pF, whichever is larger. X7R : Within ±12.5%. * Q/D.F. : C0G : Cap.>30pF, Q≥350; 10pF≤Cap.≤30pF, Q≥275+2.5C; Cap.<10pF, Q≥200+10C. X7R : D.F.≤200% of initial requirement. * I.R. (Class I) : ≥1GΩ or RxC≥50Ω-F, whichever is smaller. * I.R. (Class II) : ≥1GΩ or RxC≥10Ω-F, whichever is smaller. | | | | | | |
| 11. | Humidity (Damp Heat) Load | * Test temp. : 40±2°C. * Humidity : 90~95% RH. * Test time : 500 +24/-0hrs. * To apply voltage : 500Vdc. * Measurement to be made after keeping at room temp. for 24±2 hrs (Class I) or 48±4 hrs (Class II). | * No remarkable damage. * Cap. change : C0G : Within ±7.5% or ±0.75pF, whichever is larger. X7R : Within ±12.5%. * Q/D.F. : C0G : Cap.≥30pF, Q≥200; Cap.<30pF, Q≥100+10/3C. X7R : D.F.≤200% of initial requirement. * I.R. : ≥500MΩ or RxC≥25Ω-F, whichever is smaller. | | | | | | |
| 12. | High Temperature Load (Endurance) | * Test temp. : 125±3°C. * Apply voltage : 100% of rated voltage. * Test time : 1000 +24/-0 hrs. * Measurement to be made after keeping at room temp. for 24±2 hrs (Class I) or 48±4 hrs (Class II). | * No remarkable damage. * Cap. change : C0G : Within ±3.0% or ±0.3pF, whichever is larger. X7R : Within ±12.5%. * Q/D.F. : C0G : Cap.>30pF, Q≥350; 10pF≤Cap.≤30pF, Q≥275+2.5C; Cap.<10pF, Q≥200+10C. X7R : D.F.≤200% of initial requirement. * I.R. (Class I) : ≥1GΩ or RxC≥50Ω-F, whichever is smaller. * I.R. (Class II) : ≥1GΩ or RxC≥10Ω-F, whichever is smaller. | | | | | | |
| 13 | Resistance to Flexure of Substrate (Substrate bending test) | * The middle part of substrate shall be pressurized by means of the pressurizing rod at a rate of about 1mm per second until the deflection becomes 1mm.  <p style="text-align: center;">Unit : mm</p> | *No remarkable damage. <table border="1" style="width: 100%;"> <thead> <tr> <th>Dielectric</th> <th>Cap. Change</th> </tr> </thead> <tbody> <tr> <td>Class I (C0G)</td> <td>Within ±3.0% or ±2.0pF, whichever is larger</td> </tr> <tr> <td>Class II (X7R)</td> <td>Within ±12.5%</td> </tr> </tbody> </table> (This capacitance change means the change of capacitance under specified flexure of substrate from the capacitance measured before the test) | Dielectric | Cap. Change | Class I (C0G) | Within ±3.0% or ±2.0pF, whichever is larger | Class II (X7R) | Within ±12.5% |
| Dielectric | Cap. Change | | | | | | | | |
| Class I (C0G) | Within ±3.0% or ±2.0pF, whichever is larger | | | | | | | | |
| Class II (X7R) | Within ±12.5% | | | | | | | | |
| 14. | Adhesive Strength of Termination (Robustness of termination) | * Capacitors mounted on a substrate. A force of 5N(≤0603) or 10N(>0603) applied perpendicular to the place of substrate and parallel the line joining the center of terminations for 10±1 second.  | * No remarkable damage or removal of the terminations. | | | | | | |

| | | |
|---------------------------------|--|---|
| 15. Vibration Resistance | * Vibration frequency : 10~55 Hz/min. * Total amplitude : 1.5mm. * Test time : 6 hrs. (Two hrs each in three mutually perpendicular directions) * Measurement to be made after keeping at room temp. for 24±2 hrs (Class I) or 48±4 hrs (Class II). | * No remarkable damage. * Cap. change and Q/D.F. : To meet the initial spec. |
|---------------------------------|--|---|

Prosperity Dielectrics Co., Ltd.

9. PACKAGE DIMENSION AND QUANTITY

| Size | Thickness (mm) | Paper tape | | Plastic tape | |
|------------|------------------|------------|----------|--------------|----------|
| | | 7" reel | 13" reel | 7" reel | 13" reel |
| 0402(1005) | 0.50±0.05 | 10k | 50K | - | - |
| 0603(1608) | 0.80±0.07 | 4k | 15k | - | - |
| | 0.80 +0.15/-0.10 | 4k | 15k | - | - |
| 0805(2012) | 0.60±0.10 | 4k | 15k | - | - |
| | 0.80±0.10 | 4k | 15k | - | - |
| | 1.25±0.10 | - | - | 3k | 10k |
| | 1.25±0.20 | - | - | 3k | - |
| 1206(3216) | 0.80±0.10 | 4k | 15k | - | - |
| | 0.95±0.10 | - | - | 3k | 10k |
| | 1.25±0.10 | - | - | 3k | 10k |
| | 1.60±0.20 | - | - | 2k | - |
| 1210(3225) | 0.95±0.10 | - | - | 3k | 10k |
| | 1.25±0.10 | - | - | 3k | 10k |
| | 1.60±0.20 | - | - | 2k | - |
| | 2.50±0.30 | - | - | 1k | - |
| 1808(4520) | 1.25±0.10 | - | - | 2k | - |
| | 1.60±0.20 | - | - | 2k | - |
| | 2.00±0.20 | - | - | 1k | - |
| 1812(4532) | 1.25±0.10 | - | - | 1k | - |
| | 1.60±0.20 | - | - | 1k | - |
| | 2.00±0.20 | - | - | 1k | - |
| | 2.50±0.30 | - | - | 0.5k | - |
| 1825(4563) | 1.60±0.20 | - | - | 1k | - |
| | 2.00±0.20 | - | - | 1k | - |
| | 2.50±0.30 | - | - | 0.5k | - |
| | 2.80±0.30 | - | - | 0.5k | - |
| 2211(5728) | 1.60±0.20 | - | - | 1k | - |
| | 2.00±0.20 | - | - | 1k | - |
| | 2.50±0.30 | - | - | 0.5k | - |
| | 2.80±0.30 | - | - | 0.5k | - |
| 2220(5750) | 1.60±0.20 | - | - | 1k | - |
| | 2.00±0.20 | - | - | 1k | - |
| | 2.50±0.30 | - | - | 0.5k | - |
| | 2.80±0.30 | - | - | 0.5k | - |
| 2225(5763) | 1.60±0.20 | - | - | 1k | - |
| | 2.00±0.20 | - | - | 1k | - |
| | 2.50±0.30 | - | - | 0.5k | - |
| | 2.80±0.30 | - | - | 0.5k | - |

Unit : pcs

Prosperity Dielectrics Co., Ltd.

9. PACKAGE DIMENSION AND QUANTITY

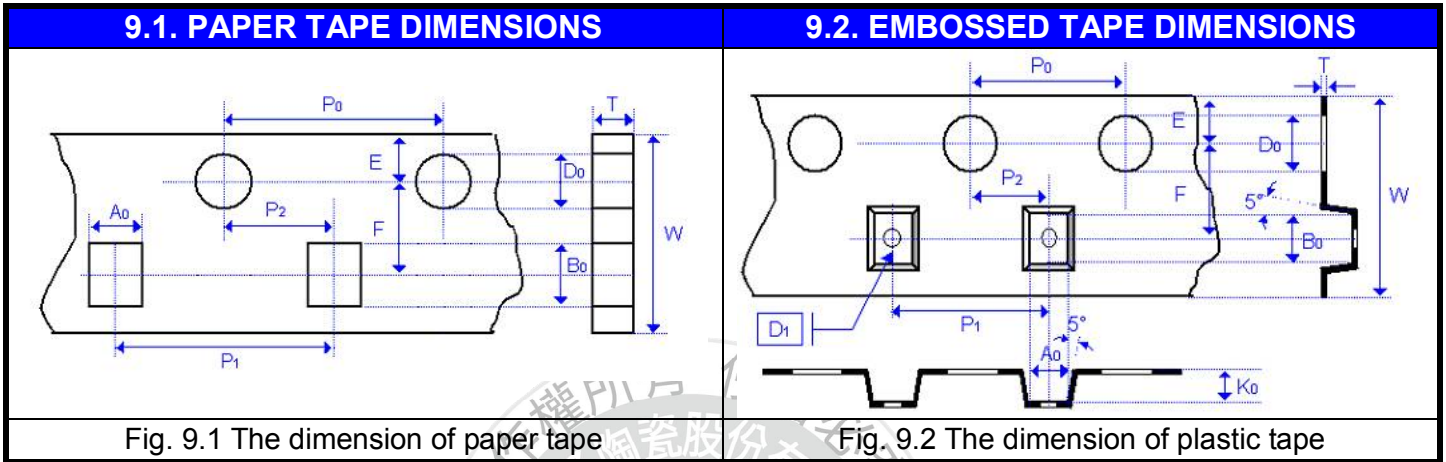

| Size | 0603 | | 0805 | | 1206 | | |
|-------------------|---------------------|---------------------|------------|------------------------|------------|------------------------|----------------------------|
| Chip Thickness | 0.80±0.07 | 0.80 +0.15/-0.1 | 0.80±0.10 | 1.25±0.10 1.25±0.20 | 0.80±0.10 | 0.95±0.10 1.25±0.10 | 1.60±0.20 1.60+0.3/-0.1 |
| A ₀ | 1.00 +0.05/-0.10 | 1.02 +0.05/-0.10 | 1.50±0.10 | <1.65 | 2.00±0.10 | <2.00 | <2.00 |
| B ₀ | 1.80±0.10 | 1.80±0.10 | 2.30±0.10 | <2.40 | 3.50±0.10 | <3.60 | <3.70 |
| T | 0.95±0.05 | 0.97±0.05 | 0.95±0.05 | 0.23±0.05 | 0.95±0.05 | 0.23±0.05 | 0.23±0.05 |
| K ₀ | - | - | - | <2.50 | - | <2.50 | <2.50 |
| W | 8.00±0.10 | 8.00±0.10 | 8.00±0.10 | 8.00±0.10 | 8.00±0.10 | 8.00±0.10 | 8.00±0.10 |
| P ₀ | 4.00±0.10 | 4.00±0.10 | 4.00±0.10 | 4.00±0.10 | 4.00±0.10 | 4.00±0.10 | 4.00±0.10 |
| 10xP ₀ | 40.00±0.20 | 40.00±0.20 | 40.00±0.20 | 40.00±0.20 | 40.00±0.20 | 40.00±0.20 | 40.00±0.20 |
| P ₁ | 4.00±0.10 | 4.00±0.10 | 4.00±0.10 | 4.00±0.10 | 4.00±0.10 | 4.00±0.10 | 4.00±0.10 |
| P ₂ | 2.00±0.05 | 2.00±0.05 | 2.00±0.05 | 2.00±0.05 | 2.00±0.05 | 2.00±0.05 | 2.00±0.05 |
| D ₀ | 1.55±0.05 | 1.55±0.05 | 1.55±0.05 | 1.50 +0.10/-0 | 1.55±0.05 | 1.50 +0.10/-0 | 1.50 +0.10/-0 |
| D ₁ | - | - | - | 1.00±0.10 | - | 1.00±0.10 | 1.00±0.10 |
| E | 1.75±0.05 | 1.75±0.05 | 1.75±0.05 | 1.75±0.10 | 1.75±0.10 | 1.75±0.10 | 1.75±0.10 |
| F | 3.50±0.05 | 3.50±0.05 | 3.50±0.05 | 3.50±0.05 | 3.50±0.05 | 3.50±0.05 | 3.50±0.05 |
| Unit : | mm | mm | mm | mm | mm | mm | mm |

| Size | 1210 | | 1808 | | 1812 | |
|-------------------|-------------------------------------|------------|------------------------|------------|-------------------------------------|------------|
| Chip Thickness | 0.95±0.10 1.25±0.10 1.60±0.20 | 2.50±0.30 | 1.25±0.10 1.60±0.20 | 2.00±0.20 | 1.25±0.10 1.60±0.20 2.00±0.20 | 2.50±0.30 |
| A ₀ | <3.05 | <3.10 | <2.50 | <2.50 | <3.90 | <3.90 |
| B ₀ | <3.80 | <4.00 | <5.30 | <5.30 | <5.30 | <5.30 |
| T | 0.23±0.05 | 0.23±0.05 | 0.25±0.05 | 0.25±0.05 | 0.25±0.05 | 0.25±0.05 |
| K ₀ | <2.50 | <3.50 | <2.50 | <2.50 | <2.50 | <3.00 |
| W | 8.00±0.10 | 8.00±0.10 | 12.00±0.20 | 12.00±0.20 | 12.00±0.20 | 12.00±0.20 |
| P ₀ | 4.00±0.10 | 4.00±0.10 | 4.00±0.10 | 4.00±0.10 | 4.00±0.10 | 4.00±0.10 |
| 10xP ₀ | 40.00±0.20 | 40.00±0.20 | 40.00±0.20 | 40.00±0.20 | 40.00±0.20 | 40.00±0.20 |
| P ₁ | 4.00±0.10 | 4.00±0.10 | 4.00±0.10 | 4.00±0.10 | 8.00±0.10 | 8.00±0.10 |
| P ₂ | 2.00±0.05 | 2.00±0.05 | 2.00±0.05 | 2.00±0.05 | 2.00±0.05 | 2.00±0.05 |

| | | | | | | |
|----------------------|---------------|---------------|---------------|---------------|---------------|---------------|
| D₀ | 1.50 +0.10/-0 | 1.50 +0.10/-0 | 1.50 +0.10/-0 | 1.50 +0.10/-0 | 1.50 +0.10/-0 | 1.50 +0.10/-0 |
| D₁ | 1.00±0.10 | 1.00±0.10 | 1.50±0.10 | 1.50±0.10 | 1.50±0.10 | 1.50±0.10 |
| E | 1.75±0.10 | 1.75±0.10 | 1.75±0.10 | 1.75±0.10 | 1.75±0.10 | 1.75±0.10 |
| F | 3.50±0.05 | 3.50±0.05 | 5.50±0.05 | 5.50±0.05 | 5.50±0.05 | 5.50±0.05 |
| Unit : | mm | mm | mm | mm | mm | mm |

Prosperity Dielectrics Co., Ltd.

9. PACKAGE DIMENSION AND QUANTITY

| Size | 1825 | | 2211 | | 2220 | | 2225 | |
|-------------------------|------------------------|------------------|------------------------|------------------|-------------------------------------|------------------|------------------------|------------------|
| Chip Thickness | 1.60±0.20 2.00±0.20 | 2.50±0.30 | 1.60±0.20 2.00±0.20 | 2.50±0.30 | 1.40±0.15 1.60±0.20 2.00±0.20 | 2.50±0.30 | 1.60±0.20 2.00±0.20 | 2.50±0.30 |
| A₀ | <6.80 | <6.80 | <3.30 | <3.30 | <5.80 | <5.80 | <6.80 | <6.80 |
| B₀ | <5.30 | <5.30 | <6.50 | <6.50 | <6.50 | <6.50 | <6.50 | <6.50 |
| T | 0.30±0.10 | 0.30±0.10 | 0.30±0.10 | 0.30±0.10 | 0.30±0.10 | 0.30±0.10 | 0.30±0.10 | 0.30±0.10 |
| K₀ | <2.50 | <3.10 | <2.50 | <3.10 | <2.50 | <3.10 | <2.50 | <3.10 |
| W | 12.00±0.20 | 12.00±0.20 | 12.00±0.20 | 12.00±0.20 | 12.00±0.20 | 12.00±0.20 | 12.00±0.20 | 12.00±0.20 |
| P₀ | 4.00±0.10 | 4.00±0.10 | 4.00±0.10 | 4.00±0.10 | 4.00±0.10 | 4.00±0.10 | 4.00±0.10 | 4.00±0.10 |
| 10xP₀ | 40.00±0.20 | 40.00±0.20 | 40.00±0.20 | 40.00±0.20 | 40.00±0.20 | 40.00±0.20 | 40.00±0.20 | 40.00±0.20 |
| P₁ | 8.00±0.10 | 8.00±0.10 | 8.00±0.10 | 8.00±0.10 | 8.00±0.10 | 8.00±0.10 | 8.00±0.10 | 8.00±0.10 |
| P₂ | 2.00±0.05 | 2.00±0.05 | 2.00±0.05 | 2.00±0.05 | 2.00±0.05 | 2.00±0.05 | 2.00±0.05 | 2.00±0.05 |
| D₀ | 1.50 +0.10/-0 | 1.50 +0.10/-0 | 1.50 +0.10/-0 | 1.50 +0.10/-0 | 1.50 +0.10/-0 | 1.50 +0.10/-0 | 1.50 +0.10/-0 | 1.50 +0.10/-0 |
| D₁ | 1.50±0.10 | 1.50±0.10 | 1.50±0.10 | 1.50±0.10 | 1.50±0.10 | 1.50±0.10 | 1.50±0.10 | 1.50±0.10 |
| E | 1.75±0.10 | 1.75±0.10 | 1.75±0.10 | 1.75±0.10 | 1.75±0.10 | 1.75±0.10 | 1.75±0.10 | 1.75±0.10 |
| F | 5.50±0.05 | 5.50±0.05 | 5.50±0.05 | 5.50±0.05 | 5.50±0.05 | 5.50±0.05 | 5.50±0.05 | 5.50±0.05 |
| Unit : | mm | mm | mm | mm | mm | mm | mm | mm |

9.3. REEL DIMENSIONS

| Size | 0603, 0805, 1206, 1210 | | 1808, 1812, 1825, 2211, 2220, 2225 |
|----------------------|------------------------|-------------------|---------------------------------------|
| Reel size | 7" | 13" | 7" |
| C | 13.0 +0.5/-0.2 | 13.0 +0.7/-0.3 | 13.0 +0.5/-0.2 |
| W₁ | 8.4 +1.5/-0 | 8.4 +2.0/-0 | 12.4 +2.0/-0 |
| A | 178.0 ±0.10 | 330.0 ±1.0 | 178.0 ±0.10 |
| N | 60.0 +1.0/-0 | 100 ±1.0 | 60.0 +1.0/-0 |

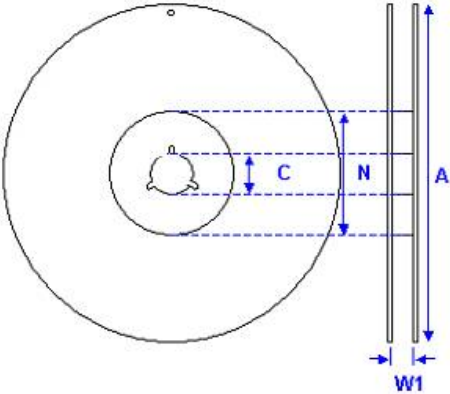

Fig. 9.3 The dimension of reel

Prosperity Dielectrics Co., Ltd.

10. APPLICATION NOTES

STORAGE

To prevent the damage of solderability of terminations, the following storage conditions are recommended :

Indoors under 5 ~ 40°C and 20% ~ 70% RH.

No harmful gases containing sulfuric acid, ammonia, hydrogen sulfide or chlorine.

Packaging should not be opened until the capacitors are required for use. If opened, the pack should be re-sealed as soon as is practicable. Taped product should be stored out of direct sunlight, which might promote deterioration in tape or adhesion performance. The product is recommended to be used within 12 months after shipment and checked the solderability before use.

HANDLING

Chip capacitors are dense, hard, brittle, and abrasive materials. They are liable to suffer mechanical damage, in the form of cracks or chips. Chip Capacitors should be handled with care to avoid contamination or damage. To use vacuum or plastic tweezers to pick up or plastic tweezers is recommended for manual placement. Tape and reeled packages are suitable for automatic pick and placement machine.

PREHEAT

In order to minimize the risk of thermal shock during soldering, a carefully controlled preheat is required. The rate of preheat should not exceed 3°C per second.

SOLDERING

Use middy activated rosin RA and RMA fluxes do not use activated flux. The amount of solder in each solder joint should be controlled to prevent the damage of chip capacitors caused by the stress between solder, chips, and substrate.

a.) Hand soldering :

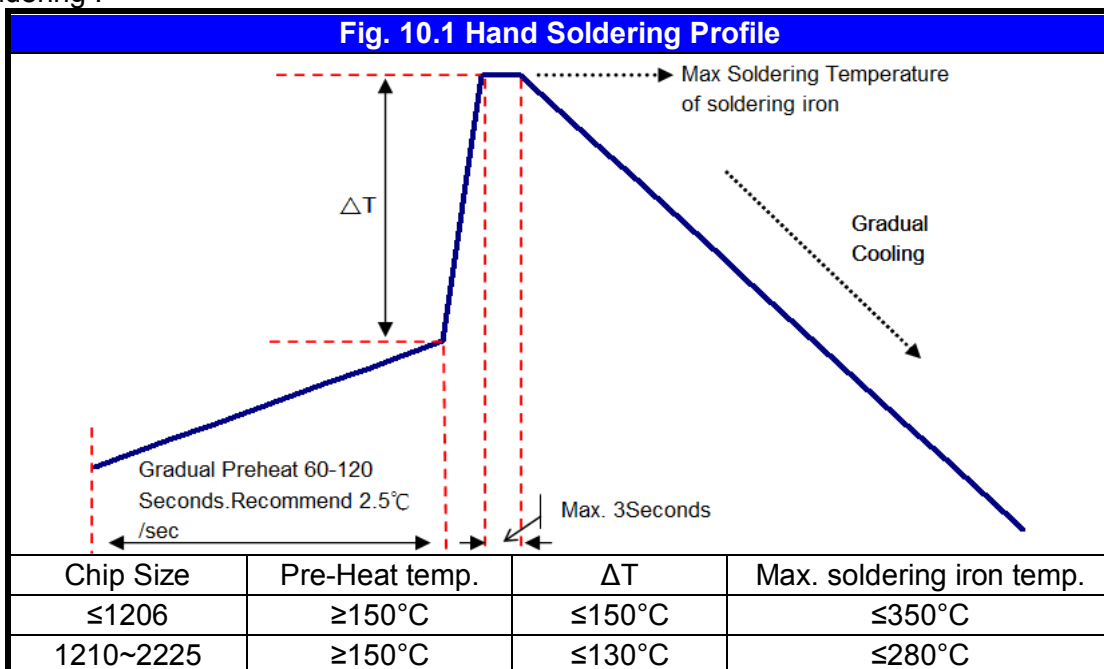

* Soldering iron tip diameter ≤ 1.0 mm and wattage max. 20W.

* The Capacitors shall be pre-heated and that the temperature gradient between the devices and the tip of the Specification No. : FV-000-001-22

soldering iron.

- * The required amount of solder shall be melted on the soldering tip.
- * The tip of iron should not contact the ceramic body directly.
- * The Capacitors shall be cooled gradually at room temperature after soldering.
- * Forced air cooling is not allowed.



10. APPLICATION NOTES

b.) Reflow soldering :

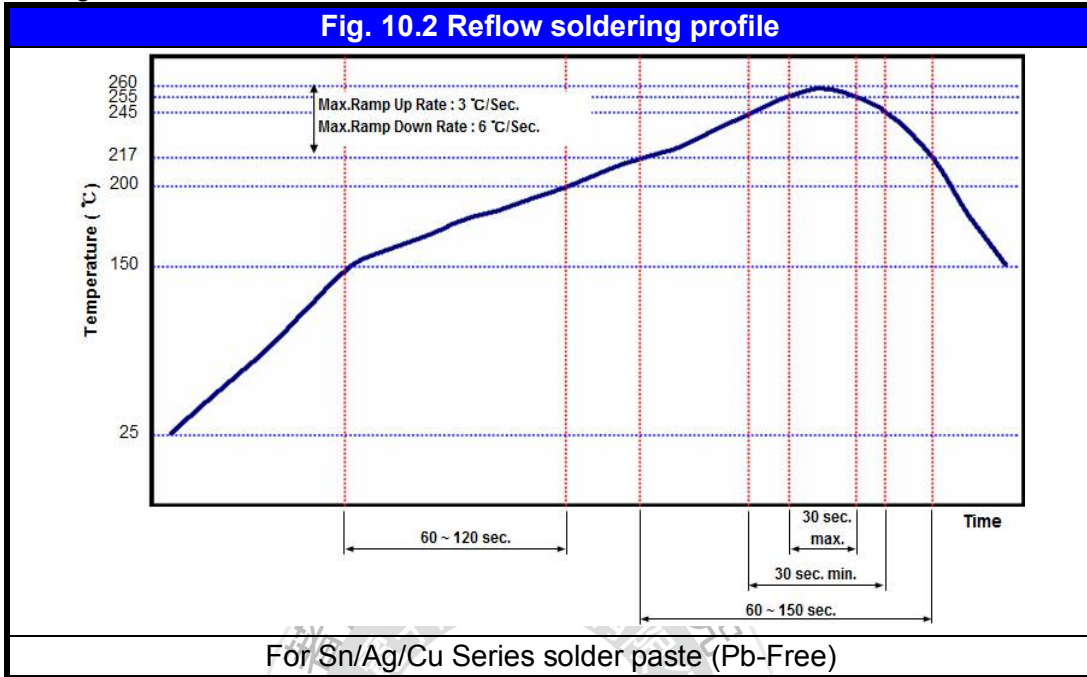

c.) Wave soldering :

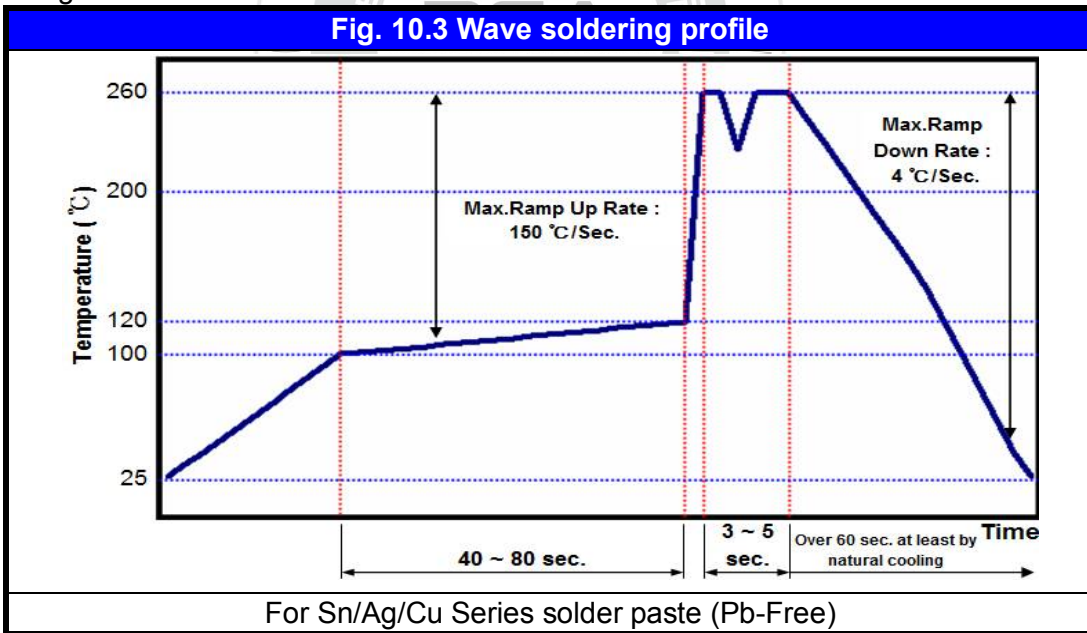

Soldering conditions :

Class I :

| Size Inch (mm) | Temper. Char. | Capacitance | Condition | |
|----------------|---------------|-------------|-----------|--------|
| | | | Wave | Reflow |
| ≤0402 (1005) | Class I - C0G | All | X | O |
| 0603 (1608) | Class I - C0G | All | O | O |
| 0805 (2012) | Class I - C0G | All | O | O |
| 1206 (3216) | Class I - C0G | All | O | O |
| ≥1210 (3225) | Class I - C0G | All | X | O |

10. APPLICATION NOTES

Soldering conditions :
 Class II :

| Size Inch (mm) | Temper. Cher. | Capacitance | Condition | |
|----------------|----------------|-------------|-----------|--------|
| | | | Wave | Reflow |
| ≤0402 (1005) | Class II - X7R | All | X | O |
| 0603 (1608) | Class II - X7R | Cap. <2.2μF | O | O |
| | | Cap. ≥2.2μF | X | O |
| 0805 (2012) | Class II - X7R | Cap. <4.7μF | O | O |
| | | Cap. ≥4.7μF | X | O |
| 1206 (3216) | Class II - X7R | Cap. <4.7μF | O | O |
| | | Cap. ≥4.7μF | X | O |
| ≥1210 (3225) | Class II - X7R | All | X | O |

Soldering height :

The solder climbing minimum height is suggesting to 25% of chip thickness or 500um whichever is less.
 (Reference from IPC-610E)

The diagram illustrates a cross-section of a chip on a substrate. The chip is shown in yellow and grey. A vertical double-headed arrow on the left indicates the 'Chip Thickness'. A vertical double-headed arrow on the right indicates the 'Soldering Height', which is the height of the solder joint on the substrate.

COOLING

After soldering, cool the chips and the substrate gradually to room temperature. Natural cooling in air is recommended to minimize stress in the solder joint.

CLEANING

All flux residues must be removed by using suitable electronic-grade vapor-cleaning solvents to eliminate contamination that could cause electrolytic surface corrosion. Good results can be obtained by using ultrasonic cleaning of the solvent. The choice of the proper system is depends upon many factors such as component mix, flux, and solder paste and assembly method. The ability of the cleaning system to remove flux residues and contamination from under the chips is very important.

Surface coating products are not suitable cleaning/washing by solvent

X-ON Electronics

Largest Supplier of Electrical and Electronic Components

Click to view similar products for [Multilayer Ceramic Capacitors MLCC - SMD/SMT](#) category:

Click to view products by [Prosperity](#) manufacturer:

Other Similar products are found below :

[M39014/02-1218V](#) [M39014/02-1225V](#) [M39014/22-0631](#) [D55342E07B523DR-T/R](#) [NCA1206X7R104K16TRPF](#) [NIN-FB391JTRF](#) [NIN-FC2R7JTRF](#) [NMC0402NPO220J50TRPF](#) [NMC0402X5R105K6.3TRPF](#) [NMC0402X5R224K6.3TRPF](#) [NMC0402X7R103J25TRPF](#) [NMC0402X7R153K16TRPF](#) [NMC0603NPO101F50TRPF](#) [NMC0603NPO1R8C50TRPF](#) [NMC0603NPO201J50TRPF](#) [NMC0603X5R475M6.3TRPF](#) [NMC0805NPO270J50TRPF](#) [NMC0805NPO681F50TRPF](#) [NMC0805NPO820J50TRPF](#) [NMC0805X7R224K16TRPLPF](#) [NMC0805X7R224K25TRPF](#) [NMC1206X7R102K50TRPF](#) [NMC1206X7R475K10TRPLPF](#) [NMC-Q0402NPO8R2D200TRPF](#) [C1206C101J1GAC](#) [C1608C0G2A221J](#) [C1608X7R1E334K](#) [C2012C0G2A472J](#) [2220J2K00562KXT](#) [1812J2K00332KXT](#) [CDR04BX104AKSR](#) [CDR31BX103AKWR](#) [CDR33BX104AKUR](#) [CDR33BX683AKUS](#) [CGA2B2C0G1H010C](#) [CGA2B2C0G1H040C](#) [CGA2B2C0G1H050C](#) [CGA2B2C0G1H060D](#) [CGA2B2C0G1H070D](#) [CGA2B2C0G1H120J](#) [CGA2B2C0G1H151J](#) [CGA2B2C0G1H1R5C](#) [CGA2B2C0G1H2R2C](#) [CGA2B2C0G1H390J](#) [CGA2B2C0G1H391J](#) [CGA2B2C0G1H3R3C](#) [CGA2B2C0G1H680J](#) [CGA2B2C0G1H6R8D](#) [CGA2B2C0G1H820J](#) [CGA2B2X8R1H152K](#)