

Prosperity Dielectrics Co., Ltd.

No.566-1, Kaoshi Rd., Yangmei, Taoyuan 32668, Taiwan (R.O.C.)

Tel : 886-3-4753355

Fax : 886-3-4854959

Messrs. : 一般共用

Date : 2021/06/11

APPROVAL SHEET

Product Name : High Voltage Multilayer Ceramic Chip Capacitors

Part No. : FV Series

Description : Size 0805~2225, C0G/X7R, 1000V~4000V

PREPARED BY	APPROVED BY

信昌電子陶瓷股份有限公司

PROSPERITY DIELECTRICS CO., LTD.

桃園市楊梅區高獅路 566-1 號 <http://www.pdc.com.tw>

Tel : 03-4753355 ext :

Fax : 03-4854959

Contactor : _____ **Mobile :** _____

Prosperity Dielectrics Co., Ltd.

No.566-1, Kaoshi Rd., Yangmei, Taoyuan 32668, Taiwan (R.O.C.)

Tel : 886-3-4753355

Fax : 886-3-4854959

SPECIFICATION

FOR

Product Name : High Voltage Multilayer Ceramic Chip Capacitors

Part No. : FV Series

Description : Size 0805~2225, C0G/X7R, 1000V~4000V

SPEC. No. : FV-000-001-22

DATE : 2021/06/11

DRAWN BY	CHECEKED BY	APPROVED BY
<i>Jane Hsiao</i>	<i>Yvens Chou</i>	<i>Joseph Ling</i>

1. INTRODUCTION

PDC FV Series green type capacitors are manufactured by using environmental friendly material without lead or cadmium. These capacitors feature series connection of multi-layer capacitor units in a MLCC to realize high voltage performance. This special design can distribute voltage gradients throughout the entire capacitor, so as to prevent short circuit failure. It is a safety design for LCD back-lighting inverter application.

2. FEATURES

- Special interior design offers high voltage rating in a given case size.
- High reliability and stability.
- RoHS & HALOGEN compliant.

3. APPLICATIONS

- DC to DC converter.
- High voltage coupling/DC blocking.
- Back-lighting inverters.
- LAN/WLAN interface.
- Modem.
- Power supplies.

4. HOW TO ORDER

<u>FV</u>	<u>31</u>	<u>X</u>	<u>103</u>	<u>K</u>	<u>102</u>	<u>E</u>	<u>E</u>	<u>G</u>
PDC Family	Size	Dielectric	Capacitance	Tolerance	Rated Voltage	Packaging	Thickness	Control Code
Table 1	Table 2	Table 3	Table 4	Table 5	Table 6	Table 7	Table 8	Table 9

Table 1 PDC Family	
Code	Description
FV	High voltage application with ≥1KVdc

Table 2 Size					
Code	Description	Code	Description	Code	Description
15	0402 (1005)	32	1210 (3225)	52	2211 (5728)
18	0603 (1608)	42	1808 (4520)	55	2220 (5750)
21	0805 (2012)	43	1812 (4532)	56	2225 (5763)
31	1206 (3216)	46	1825 (4563)		

Table 3 Dielectric Material Characteristics			
Code	Description	Code	Description
N	C0G	X	X7R

Table 4 Capacitance Rule Code			
Code	Description	Code	Description
R47	0.47pF	102	102=10x10 ² =1000pF
0R5	0.5pF	104	104=10x10 ⁴ =100nF
100	100=10x10 ⁰ =10pF	106	106=10x10 ⁶ =10μF

Table 5 Tolerance					
Code	Description	Code	Description	Code	Description
A	±0.05 pF	J	±5 %		
B	±0.10 pF	K	±10 %		
C	±0.25 pF	L	0% ~ +10%		
D	±0.50 pF	M	±20 %		
F	±1 %	N	-5% ~ +10%		
G	±2 %	P	±0.02 pF		
H	±3 %	Q	±0.03 pF		
I	-10% ~ 0%	Z	-20% ~ +80%		

Table 6 Rated Voltage					
Code	Description	Code	Description	Code	Description
102	1000Vdc	252	2500Vdc	502	5000Vdc
152	1500Vdc	302	3000Vdc	602	6000Vdc
202	2000Vdc	402	4000Vdc		

Table 7 Packaging Type			
Code	Description	Code	Description
B	Bulk	T	Tray package
E	Tape and 7" Reel, Embossed Tape	P	Tape and 7" Reel, Paper Tape
K	Tape and 10" Reel, Embossed Tape	D	Tape and 10" Reel, Paper Tape
L	Tape and 13" Reel, Embossed Tape	G	Tape and 13" Reel, Paper Tape

Table 8 Thickness Description					
Code	Description	Code	Description	Code	Description
A	0.60 ± 0.10 mm	I	1.25 ± 0.20 mm	Q	0.50 +0.02/-0.05 mm
B	0.8+0.15/-0.10 mm	J	1.15 ± 0.15 mm	R	3.10 ± 0.30 mm
C	1.25 ± 0.10 mm	K	0.50 ± 0.20 mm	S	0.80 ± 0.07 mm
D	1.40 ± 0.15 mm	L	0.30 ± 0.03 mm	T	0.85 ± 0.10 mm
E	1.60 ± 0.20 mm	M	0.95 ± 0.10 mm	U	0.50 ± 0.10 mm
F	2.00 ± 0.20 mm	N	0.50 ± 0.05 mm	V	0.20 ± 0.02 mm
G	2.50 ± 0.30 mm	O	3.50 ± 0.20 mm	X	0.80 ± 0.10 mm
H	2.80 ± 0.30 mm	P	1.60+0.3/-0.10 mm	Z	0.25 ± 0.03 mm

Table 9 Special Control Code	
Code	Description
G	RoHS compliant
Q	Surface Coating (Size 1206~2225)

5. EXTERNAL DIMENSIONS

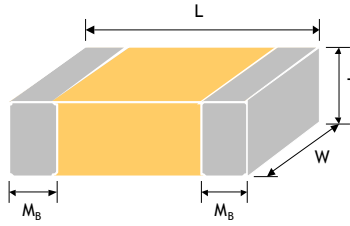
Size Inch (mm)	L (mm)	W (mm)	Code / T (mm)	M _B (mm)	
0805(2012)	2.10±0.20	1.25±0.20	See No.4 Reference Table 8	0.50±0.20	
1206(3216)	3.30±0.30	1.60±0.20 1.60 +0.3/-0.1*		0.60±0.20	
1210(3225)	3.30±0.40	2.50±0.30		0.75±0.35	
1808(4520)	4.50 +0.50/-0.30	2.00±0.25		0.75±0.35	
1812(4532)	4.50 +0.50/-0.30	3.20±0.40		0.75±0.35	
1825(4563)	4.50 +0.50/-0.30	6.30±0.40		0.75±0.35	
2211(5728)	5.70±0.40	2.80±0.30		0.85±0.35	
2220(5750)	5.70±0.40	5.00±0.40		0.85±0.35	
2225(5763)	5.70±0.40	6.30±0.40		0.85±0.35	

* for 1206 P thickness products.

6. GENERAL ELECTRICAL DATA

Dielectric	C0G		X7R
Size	0805, 1206, 1210, 1808, 1812, 1825, 2220, 2225		0805, 1206, 1210, 1808, 1812, 1825, 2211, 2220, 2225
Rated voltage (WVDC)	1000V, 1500V, 2000V, 3000V, 4000V		1000V, 1500V, 2000V, 3000V, 4000V
Capacitance range	1.5pF ~ 10nF		100pF ~ 220nF
Capacitance tolerance	Reference to Table 5		Reference to Table 5
Tan δ	Cap. Rang	Q Spec.	≤2.5%
	Cap.<30pF	Q≥400+20C	
	Cap.≥30pF	Q≥1000	
Capacitance & Tan δ Test condition	Measured at the condition of 30~70% related humidity		
	For 25°C at ambient temperature		Preconditioning for Class II MLCC : Perform a heat treatment at 150±10°C for 1 hour, then leave in ambient condition for 24±2 hours before measurement
	Cap. Rang	Test Condition	1.0±0.2Vrms, 1.0KHz±10%, at 25°C ambient temperature
Cap.≤1000pF	1.0±0.2Vrms, 1.0MHz±10%		
Cap.>1000pF	1.0±0.2Vrms, 1.0KHz±10%		
Insulation resistance at Ur	≥10GΩ or RxC≥500Ω-F, whichever is smaller		≥10GΩ or RxC≥100Ω-F, whichever is smaller
Operating temperature	-55°C to +125°C		
Capacitance characteristic	±30ppm/°C		±15%
Termination	Cu or Ag/Ni/Sn or Au (lead-free termination)		

7. CAPACITANCE RANGE

7-1. C0G

Dimension		0805	1206				1210			
Cap.(pF)	Code	1000V	1000V	1500V	2000V	3000V	1000V	1500V	2000V	3000V
1.5	1R5	C	X	X	X					
1.8	1R8	C	X	X	X					
2.2	2R2	C	X	X	X					
2.7	2R7	C	X	X	X					
3.3	3R3	C	X	X	X					
3.9	3R9	C	X	X	X					
4.7	4R7	C	X	X	X					
5.0	5R0	C	X	X	X					
5.6	5R6	C	X	X	X					
6.8	6R8	C	X	X	X					
8.2	8R2	C	X	X	X					
10	100	C	X	X	X	E	M	M	M	F
12	120	C	X	X	X	E	M	M	M	F
15	150	C	X	X	X	E	M	M	M	F
18	180	C	X	X	X	E	M	M	M	F
22	220	C	X	X	X	E	M	M	M	F
27	270	C	X	X	X	E	M	M	M	F
33	330	C	X	M	M	E	M	M	M	F
39	390	C	X	M	M	E	M	M	M	F
47	470	C	X	M	M	E	M	M	M	F
56	560	C	X	C	C	E	M	C	C	F
68	680	C	X	C	C	E	M	C	C	F
82	820	C	X	C	C	E	M	C	C	F
100	101	C	X	C	C	E	C	C	C	F
120	121	C	X/C	E	E	E	C	C	C	F
150	151	C	C	E	E		C	E	E	F
180	181	C	E/C	E	E		C	E	E	F
220	221	C	E/C	E	E		E	E	E	F
270	271	C	E/C	P	P		E	F	F	G
330	331	C	E/C	P/E	P/E		E	F	F	
390	391	C	E/C	P/E	P/E		E	G	G	
470	471		E/C	E	E		E	C	C	
560	561		E				E	G	G	
680	681		E				E	G	G	
820	821		E				E	G	G	
1000	102		E				E	G	G	
1200	122						E	F	F	
1500	152						F	G	G	
1800	182						G	G	G	
2200	222						G			
2700	272						G			
3300	332						G			
3900	392						G			

PSA 信昌電子陶瓷股份有限公司
Prosperity Dielectrics Co., Ltd.

7. CAPACITANCE RANGE(Con.)

7-1. C0G

Dimension		1808					1812					1825			
Cap.(pF)	Code	1000V	1500V	2000V	3000V	4000V	1000V	1500V	2000V	3000V	4000V	1000V	1500V	2000V	3000V
1.5	1R5														
1.8	1R8														
2.2	2R2	C	C	C	C	C									
2.7	2R7	C	C	C	C	C									
3.3	3R3	C	C	C	C	C									
3.9	3R9	C	C	C	C	C									
4.7	4R7	C	C	C	C	C									
5.0	5R0	C	C	C	C	C									
5.6	5R6	C	C	C	C	C									
6.8	6R8	C	C	C	C	C									
8.2	8R2	C	C	C	C	C									
10	100	C	C	C	C	C	C	C	C	C	C	F	F	F	F
12	120	C	C	C	C	C	C	C	C	C	C	F	F	F	F
15	150	C	C	C	C	C	C	C	C	C	C	F	F	F	F
18	180	C	C	C	C	C	C	C	C	C	C	F	F	F	F
22	220	C	C	C	C	E	C	C	C	C	C	F	F	F	F
27	270	C	C	C	C	E	C	C	C	C	C	F	F	F	F
33	330	C	C	C	C	E*	C	C	C	C	C	F	F	F	F
39	390	C	C	C	C	F*	C	C	C	C	C*	F	F	F	F
47	470	C	C	C	C	G	C	C	C	C	C*	F	F	F	F
56	560	C	C	C	C	G	C	C	C	C	E*	F	F	F	F
68	680	C	C	C	C	G	C	C	C	C	E*	F	F	F	F
82	820	C	C	C	C	G	C	C	C	C	F*	F	F	F	F
100	101	C	C	C	F	G	C	C	C	C	F*	F	F	F	F
120	121	C	C	C	F	G	C	C	C	C	G*	F	F	F	F
150	151	C	F	F	F	G	C	C	C	C		F	F	F	F
180	181	C	F	F	F	G	C	C	C	F		F	F	F	F
220	221	C	F	F	F	G	C	C	C	F		F	F	F	F
270	271	F	F	F	F	G	C	F	F	F		F	F	F	F
330	331	F	F	F	F	G	C	F	F	F		F	F	F	F
390	391	F	F	F	F	G	C	F	F	F		F	F	F	F
470	471	F	F	F	F	G	F	F	F	F		F	F	F	F
560	561	F	F	F	F	G	F	F	F	F		F	F	F	F
680	681	F	F	F	F	G	F	F	F	F		F	F	F	F
820	821	F	F	F	F	G	F	F	F	G		F	F	F	F
1000	102	F	F	F	F	G	F	F	F	G		F	F	F	F
1200	122	F	F	F	F	G	F	F	F	R		F	F	F	
1500	152	F	F	F	F	G	F	F	F			F	F	F	
1800	182	F	F	F	F	G	E	F	F			F	F	F	
2200	222	F	F	F	F	G	E	F	F			F	F	F	
2700	272					G	F	G	G			F	F	F	
3300	332					G	F	G	G			F	F	F	
3900	392					G	G					F	F	F	
4700	472					G	G					F	F	F	
5600	562					G	G					F			
6800	682					G	G					F			
8200	822					G	G					G			
10000	103					G	G					G			
12000	123					G	G					G			

7. CAPACITANCE RANGE(Con.)

7-1. C0G

Dimension		2220					2225				
Cap.(pF)	Code	1000V	1500V	2000V	3000V	4000V	1000V	1500V	2000V	3000V	4000V
1.5	1R5										
1.8	1R8										
2.2	2R2										
2.7	2R7										
3.3	3R3										
3.9	3R9										
4.7	4R7										
5.0	5R0										
5.6	5R6										
6.8	6R8										
8.2	8R2										
10	100	F	F	F	F	F	F	F	F	F	F
12	120	F	F	F	F	F	F	F	F	F	F
15	150	F	F	F	F	F	F	F	F	F	F
18	180	F	F	F	F	F	F	F	F	F	F
22	220	F	F	F	F	F	F	F	F	F	F
27	270	F	F	F	F	F	F	F	F	F	F
33	330	F	F	F	F	F	F	F	F	F	F
39	390	F	F	F	F	F	F	F	F	F	F
47	470	F	F	F	F	F	F	F	F	F	F
56	560	F	F	F	F	F	F	F	F	F	F
68	680	F	F	F	F	F	F	F	F	F	F
82	820	F	F	F	F	F	F	F	F	F	F
100	101	F	F	F	F	F	F	F	F	F	F
120	121	F	F	F	F	F	F	F	F	F	
150	151	F	F	F	F	F	F	F	F	F	
180	181	F	F	F	F	F	F	F	F	F	
220	221	F	F	F	F	F	F	F	F	F	
270	271	F	F	F	F	G	F	F	F	F	
330	331	F	F	F	F	G	F	F	F	F	
390	391	F	F	F	F		F	F	F	F	
470	471	F	F	F	F		F	F	F	F	
560	561	F	F	F	F		F	F	F	F	
680	681	F	F	F	F		F	F	F	F	
820	821	F	F	F	F		F	F	F	F	
1000	102	F	F	F	F		F	F	F	F	
1200	122	F	F	F	F		F	F	F	F	
1500	152	F	F	F	F		F	F	F	F	
1800	182	F	F	F			F	F	F	F	
2200	222	F	F	F			F	F	F	F	
2700	272	F	F	F			F	F	F	G	
3300	332	F	F	F			F	F	F	G	
3900	392	F	F	F			F	F	F		
4700	472	F	F	F			F	F	F		
5600	562	F					F	F	F		
6800	682	F					F	F	F		
8200	822	G					F	G	G		
10000	103	G					G	G	G		
12000	123										

PSA 信昌電子陶瓷股份有限公司
Prosperity Dielectrics Co., Ltd.

7. CAPACITANCE RANGE(Con.)

7-2. X7R

Dimension		0805	1206				1210			1808				
Cap.(pF)	Code	1000V	1000V	1500V	2000V	2500V	1000V	1500V	2000V	1000V	1500V	2000V	3000V	4000V
100	101	X	C	C	C	C	C	C	C					
120	121	X	C	C	C	C	C	C	C					
150	151	X	C	C	C	C	C	C	C	C	C	C	C	F*
180	181	X	C	C	C	C	C	C	C	C	C	C	C	F*
220	221	X	C	C	C	C	C	C	C/E	C	C	C	C	F*
270	271	X	C	C	C	C	C	C	C/E	C	C	C	C	F*
330	331	X	C	C	C	C	C	C	C/E	C	C	C	F	F*
390	391	X	C	C	C	C	C	C	C/E	C	C	C	F	F*
470	471	X	C	C	C	C	C	C	C/E	C	C	C	F	F*
560	561	X	C	C	C	C	C	C	C/E	C	C	C	F	F*
680	681	X	C	C	C	C*	C	C	C/E	C	C	C	F	F*
820	821	X	C	C	C	C*	C	C	C/E	C	C	C	F	F*
1000	102	X	C	C	C	C*	C	C	C/E	C	C	C/E	F	F*
1200	122	X	C	E	E	E*	C	G	C/E	C	F	F	F	
1500	152	C	C	E	E	E*	C	G	F	C	F	F	F	
1800	182	C	C	E	E	E*	C	G	F	C	F	F	F	
2200	222	C	C	E	E	E*	C	G	F	C	F	F	F	
2700	272	C	C	E	E	E*	C	G	G	C	F	F	F	
3300	332	C	C	E	E	E*	C	G	G	C	F	F	F	
3900	392	C	C	E		E*	E	G	G	C	F	F		
4700	472	C	C	E		E*	E	G/F	G/F	C	F	F		
5600	562		C	E			E	G	G*	F	F	F		
6800	682		C	E			E	G	G*	F	F	F		
8200	822		C	E			E	G	G*	F	F*			
10000	103		C	E			E	G		F	F*			
12000	123		E				E	G		F				
15000	153		E				E	G		F				
18000	183		E				E	G		F				
22000	223		E				E	G		F				
27000	273						E	G		F				
33000	333						E	G		F				
39000	393						F			F				
47000	473						G			F				
56000	563									F				
68000	683													

* Surface coating only.

Prosperity Dielectrics Co., Ltd.

7. CAPACITANCE RANGE(Con.)

7-2. X7R

Dimension		1812					1825				
Cap.(pF)	Code	1000V	1500V	2000V	3000V	4000V	1000V	1500V	2000V	3000V	4000V
270	271	C	C	C	F	F*					F*
330	331	C	C	C	F	F*					F*
390	391	C	C	C	F	F*					F*
470	471	C	C	C	F	F*					F*
560	561	C	C	C	F	F*					F*
680	681	C	C	C	F	F*					F*
820	821	C	C	C	F	F*					F*
1000	102	C	C	C	F	F*	F	F	F	F	F*
1200	122	C	C	C	F	G*	F	F	F	F	G*
1500	152	C	C	C	F	G*	F	F	F	F	G*
1800	182	C	C	C	G	G*	F	F	F	F	G*
2200	222	C	C	C	G*		F	F	F	F*	
2700	272	C	C	C	G*		F	F	F	F*	
3300	332	C	F	F	G*		F	F	F	F*	
3900	392	C	F	F	G*		F	F	F	F*	
4700	472	C	F	F	G*		F	F	F	F*	
5600	562	C	G	G			F	F	F	G*	
6800	682	C	G	G			F	F	F	G*	
8200	822	C	G	G			F	F	F	G*	
10000	103	C	G/F	G/F			F	F	F	G*	
12000	123	F					F	G	G	H*	
15000	153	F					F	G	G	H*	
18000	183	G					F	G	G	H*	
22000	223	G					F	G	G		
27000	273	G					F	H	H		
33000	333	G					F	H	H		
39000	393	G					F	H	H		
47000	473	G/F					F	H	H		
56000	563	G					F	H			
68000	683	G					F				
82000	823	G					F				
100000	104	G					G				
120000	124										
150000	154										
180000	184										
220000	224										
270000	274										
330000	334										

* Surface coating only.

Prosperity Dielectrics Co., Ltd.

7. CAPACITANCE RANGE(Con.)

7-2. X7R

Dimension		2211		2220					2225				
Cap.(pF)	Code	3000V	4000V	1000V	1500V	2000V	3000V	4000V	1000V	1500V	2000V	3000V	4000V
270	271	F	F*					F*					F*
330	331	F	F*					F*					F*
390	391	F	F*					F*					F*
470	471	F	F*					F*					F*
560	561	F	F*					F*					F*
680	681	F	F*					F*					F*
820	821	F	F*					F*					F*
1000	102	F	F*	F	F	F	F	F*	F	F	F	F	F*
1200	122	G	G*	F	F	F	F	G*	F	F	F	F	G*
1500	152	G	G*	F	F	F	F	G*	F	F	F	F	G*
1800	182	G	G*	F	F	F	F	G*	F	F	F	F	G*
2200	222	G		F	F	F	F*		F	F	F	F*	
2700	272	G		F	F	F	F*		F	F	F	F*	
3300	332	G		F	F	F	F*		F	F	F	F*	
3900	392			F	F	F	F*		F	F	F	F*	
4700	472			F	F	F	F*		F	F	F	F*	
5600	562			F	F	F	F*		F	F	F	G*	
6800	682			F	F	F	G*		F	F	F	G*	
8200	822			F	G	G	G*		F	F	F	G*	
10000	103			F	G/F	G/F	G*		F	F	F	G*	
12000	123			F	G	G	H*		F	G	G	G*	
15000	153			F	G	G	H*		F	G	G	G*	
18000	183			F	H	H	H*		F	G	G	H*	
22000	223			F	H	H			F	G/F	G/F		
27000	273			F	H	H			F	G	G		
33000	333			F	H	H			F	G	G		
39000	393			F	H	H			F	G	H		
47000	473			F	H	H			F	G	H		
56000	563			F	H	H			F	G	H		
68000	683			F					F	G			
82000	823			F					F	G			
100000	104			G					G	G			
120000	124			G/F					H				
150000	154			H					H				
180000	184			H					H				
220000	224			H					H				
270000	274								F/G/H				
330000	334								F/G/H				
390000	394												

* Surface coating only.

Prosperity Dielectrics Co., Ltd.

8. RELIABILITY TEST CONDITIONS AND REQUIREMENTS

No.	Item	Test Condition	Requirements															
1.	Visual and Dimensions	---	* No remarkable defect. * Dimensions to confirm to individual specification sheet.															
2.	Capacitance		* Shall not exceed the limits given in the detailed spec.															
3.	Q/D.F. (Tangent of loss angle)	* Class I : C0G Cap. ≤1000pF, 1.0±0.2Vrms, 1MHz±10%. Cap. >1000pF, 1.0±0.2Vrms, 1KHz±10%. * Class II : X7R 1.0±0.2Vrms, 1KHz±10%.	<table border="1"> <thead> <tr> <th>Dielectric</th> <th>Rated Vol.(V)</th> <th>Q/D.F.</th> <th>Remark</th> </tr> </thead> <tbody> <tr> <td rowspan="2">Class I (C0G)</td> <td rowspan="2">All</td> <td>Q≥1000</td> <td>Cap. ≥30pF</td> </tr> <tr> <td>Q≥400+20C</td> <td>Cap. <30pF</td> </tr> <tr> <td>Class II (X7R)</td> <td>All</td> <td>D.F. ≤2.5%</td> <td></td> </tr> </tbody> </table>	Dielectric	Rated Vol.(V)	Q/D.F.	Remark	Class I (C0G)	All	Q≥1000	Cap. ≥30pF	Q≥400+20C	Cap. <30pF	Class II (X7R)	All	D.F. ≤2.5%		
Dielectric	Rated Vol.(V)	Q/D.F.	Remark															
Class I (C0G)	All	Q≥1000	Cap. ≥30pF															
		Q≥400+20C	Cap. <30pF															
Class II (X7R)	All	D.F. ≤2.5%																
4.	Temperature Coefficient (Temperature characteristic of capacitance)	* With no electrical load. <table border="1"> <thead> <tr> <th>T.C.</th> <th>Operating Temp.</th> </tr> </thead> <tbody> <tr> <td>C0G</td> <td>-55~125°C at 25°C</td> </tr> <tr> <td>X7R</td> <td>-55~125°C at 25°C</td> </tr> </tbody> </table>	T.C.	Operating Temp.	C0G	-55~125°C at 25°C	X7R	-55~125°C at 25°C	<table border="1"> <thead> <tr> <th>T.C.</th> <th>Capacitance Change</th> </tr> </thead> <tbody> <tr> <td>C0G</td> <td>Within ±30ppm/°C</td> </tr> <tr> <td>X7R</td> <td>Within ±15%</td> </tr> </tbody> </table>	T.C.	Capacitance Change	C0G	Within ±30ppm/°C	X7R	Within ±15%			
T.C.	Operating Temp.																	
C0G	-55~125°C at 25°C																	
X7R	-55~125°C at 25°C																	
T.C.	Capacitance Change																	
C0G	Within ±30ppm/°C																	
X7R	Within ±15%																	
5.	Insulation Resistance	<table border="1"> <thead> <tr> <th>Rated Vol.(V)</th> <th>Apply Voltage</th> <th>Test Condition</th> </tr> </thead> <tbody> <tr> <td>>500</td> <td>500Vdc</td> <td>60 sec.</td> </tr> </tbody> </table>	Rated Vol.(V)	Apply Voltage	Test Condition	>500	500Vdc	60 sec.	<table border="1"> <thead> <tr> <th>Dielectric</th> <th>Requirements</th> </tr> </thead> <tbody> <tr> <td>Class I</td> <td>≥10GΩ or RxC≥500Ω-F, whichever is smaller</td> </tr> <tr> <td>Class II</td> <td>≥10GΩ or RxC≥100Ω-F, whichever is smaller</td> </tr> </tbody> </table>	Dielectric	Requirements	Class I	≥10GΩ or RxC≥500Ω-F, whichever is smaller	Class II	≥10GΩ or RxC≥100Ω-F, whichever is smaller			
Rated Vol.(V)	Apply Voltage	Test Condition																
>500	500Vdc	60 sec.																
Dielectric	Requirements																	
Class I	≥10GΩ or RxC≥500Ω-F, whichever is smaller																	
Class II	≥10GΩ or RxC≥100Ω-F, whichever is smaller																	
6.	Solderability	* Solder temperature : 235±5°C for (0603~1210). * Solder temperature : 245±5°C for (1808~2225). * Dipping time : 2±0.5 sec.	* 75% min. coverage of all metalized area.															
7.	Dielectric Strength (Voltage proof)	<table border="1"> <thead> <tr> <th>Rated Vol.(V)</th> <th>Condition</th> </tr> </thead> <tbody> <tr> <td>630≤V≤3000V</td> <td>1.2 times of U_RSYSTEM</td> </tr> <tr> <td>3000<V<5000V</td> <td>1.1 times of U_R</td> </tr> <tr> <td>≥5000V</td> <td>1.0 times of U_R</td> </tr> </tbody> </table> <p>* Duration : 1 to 5 sec. * Voltage ramp up rate ≤500Vdc/sec. * Charge and discharge current less than 50mA. * Test in insulating fluid.</p>	Rated Vol.(V)	Condition	630≤V≤3000V	1.2 times of U _R SYSTEM	3000<V<5000V	1.1 times of U _R	≥5000V	1.0 times of U _R	* No evidence of damage or flashover during test.							
Rated Vol.(V)	Condition																	
630≤V≤3000V	1.2 times of U _R SYSTEM																	
3000<V<5000V	1.1 times of U _R																	
≥5000V	1.0 times of U _R																	
8.	Resistance to Soldering Heat	* Solder temperature : 260±5°C. * Dipping time : 10±1 sec. * Preheating : 120 to 150°C for 1 minute before immerse the capacitor in a eutectic solder. * Before initial measurement (Class II only) : Perform 150 +0/-10°C for 1 hr and then set for 48±4 hrs at room temp. * Measurement to be made after keeping at room temp. for 24±2 hrs (Class I) or 48±4 hrs (Class II).	* No remarkable damage. * Cap. Change : C0G : Within ±2.5% or ±0.25pF, whichever is larger. X7R : Within ±7.5%. * Q/D.F. & I.R. : To meet the initial requirement. * 25% max. leaching on each edge.															
9.	Temperature Cycle (Rapid change of temperature)	* Conduct the five cycles according to the temperatures and time. <table border="1"> <thead> <tr> <th>Step</th> <th>Temp.(°C)</th> <th>Time(min.)</th> </tr> </thead> <tbody> <tr> <td>1</td> <td>Min. operating temp. +0/-3</td> <td>30±3</td> </tr> <tr> <td>2</td> <td>Room temp.</td> <td>2~3</td> </tr> <tr> <td>3</td> <td>Max. operating temp. +3/-0</td> <td>30±3</td> </tr> <tr> <td>4</td> <td>Room temp.</td> <td>2~3</td> </tr> </tbody> </table> <p>* Before initial measurement (Class II only) : Perform 150 +0/-10°C for 1 hr and then set for 48±4 hrs at room temp. * Measurement to be made after keeping at room temp. for 24±2 hrs (Class I) or 48±4 hrs (Class II).</p>	Step	Temp.(°C)	Time(min.)	1	Min. operating temp. +0/-3	30±3	2	Room temp.	2~3	3	Max. operating temp. +3/-0	30±3	4	Room temp.	2~3	* No remarkable damage. * Cap. change : C0G : Within ±2.5% or ±0.25pF, whichever is larger. X7R : Within ±7.5%. * Q/D.F. : C0G : To meet the initial requirement. X7R : D.F. ≤150% of initial requirement. * I.R. : To meet the initial requirement.
Step	Temp.(°C)	Time(min.)																
1	Min. operating temp. +0/-3	30±3																
2	Room temp.	2~3																
3	Max. operating temp. +3/-0	30±3																
4	Room temp.	2~3																

Prosperity Dielectrics Co., Ltd.

8. RELIABILITY TEST CONDITIONS AND REQUIREMENTS

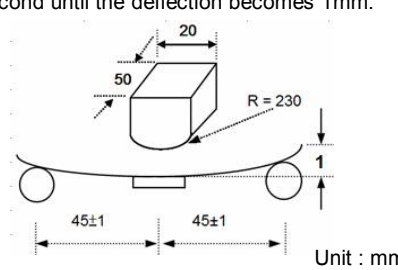
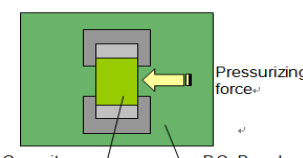
No.	Item	Test Condition	Requirements						
10.	Humidity (Damp Heat) Steady State	* Test temp. : 40±2°C. * Humidity : 90~95%RH. * Test time : 500 +24/-0 hrs. * Measurement to be made after keeping at room temp. for 24±2 hrs (Class I) or 48±4 hrs (Class II).	* No remarkable damage. * Cap. change : C0G : Within ±5.0% or ±0.5pF, whichever is larger. X7R : Within ±12.5%. * Q/D.F. : C0G : Cap.>30pF, Q≥350; 10pF≤Cap.≤30pF, Q≥275+2.5C; Cap.<10pF, Q≥200+10C. X7R : D.F.≤200% of initial requirement. * I.R. (Class I) : ≥1GΩ or RxC≥50Ω-F, whichever is smaller. * I.R. (Class II) : ≥1GΩ or RxC≥10Ω-F, whichever is smaller.						
11.	Humidity (Damp Heat) Load	* Test temp. : 40±2°C. * Humidity : 90~95% RH. * Test time : 500 +24/-0hrs. * To apply voltage : 500Vdc. * Measurement to be made after keeping at room temp. for 24±2 hrs (Class I) or 48±4 hrs (Class II).	* No remarkable damage. * Cap. change : C0G : Within ±7.5% or ±0.75pF, whichever is larger. X7R : Within ±12.5%. * Q/D.F. : C0G : Cap.≥30pF, Q≥200; Cap.<30pF, Q≥100+10/3C. X7R : D.F.≤200% of initial requirement. * I.R. : ≥500MΩ or RxC≥25Ω-F, whichever is smaller.						
12.	High Temperature Load (Endurance)	* Test temp. : 125±3°C. * Apply voltage : 100% of rated voltage. * Test time : 1000 +24/-0 hrs. * Measurement to be made after keeping at room temp. for 24±2 hrs (Class I) or 48±4 hrs (Class II).	* No remarkable damage. * Cap. change : C0G : Within ±3.0% or ±0.3pF, whichever is larger. X7R : Within ±12.5%. * Q/D.F. : C0G : Cap.>30pF, Q≥350; 10pF≤Cap.≤30pF, Q≥275+2.5C; Cap.<10pF, Q≥200+10C. X7R : D.F.≤200% of initial requirement. * I.R. (Class I) : ≥1GΩ or RxC≥50Ω-F, whichever is smaller. * I.R. (Class II) : ≥1GΩ or RxC≥10Ω-F, whichever is smaller.						
13	Resistance to Flexure of Substrate (Substrate bending test)	* The middle part of substrate shall be pressurized by means of the pressurizing rod at a rate of about 1mm per second until the deflection becomes 1mm. 	*No remarkable damage. <table border="1" data-bbox="798 1344 1484 1456"> <thead> <tr> <th>Dielectric</th> <th>Cap. Change</th> </tr> </thead> <tbody> <tr> <td>Class I (C0G)</td> <td>Within ±3.0% or ±2.0pF, whichever is larger</td> </tr> <tr> <td>Class II (X7R)</td> <td>Within ±12.5%</td> </tr> </tbody> </table> (This capacitance change means the change of capacitance under specified flexure of substrate from the capacitance measured before the test)	Dielectric	Cap. Change	Class I (C0G)	Within ±3.0% or ±2.0pF, whichever is larger	Class II (X7R)	Within ±12.5%
Dielectric	Cap. Change								
Class I (C0G)	Within ±3.0% or ±2.0pF, whichever is larger								
Class II (X7R)	Within ±12.5%								
14.	Adhesive Strength of Termination (Robustness of termination)	* Capacitors mounted on a substrate. A force of 5N(≤0603) or 10N(>0603) applied perpendicular to the place of substrate and parallel the line joining the center of terminations for 10±1 second. 	* No remarkable damage or removal of the terminations.						

15. Vibration Resistance	* Vibration frequency : 10~55 Hz/min. * Total amplitude : 1.5mm. * Test time : 6 hrs. (Two hrs each in three mutually perpendicular directions) * Measurement to be made after keeping at room temp. for 24±2 hrs (Class I) or 48±4 hrs (Class II).	* No remarkable damage. * Cap. change and Q/D.F. : To meet the initial spec.
---------------------------------	--	---

Prosperity Dielectrics Co., Ltd.

9. PACKAGE DIMENSION AND QUANTITY

Size	Thickness (mm)	Paper tape		Plastic tape	
		7" reel	13" reel	7" reel	13" reel
0402(1005)	0.50±0.05	10k	50K	-	-
0603(1608)	0.80±0.07	4k	15k	-	-
	0.80 +0.15/-0.10	4k	15k	-	-
0805(2012)	0.60±0.10	4k	15k	-	-
	0.80±0.10	4k	15k	-	-
	1.25±0.10	-	-	3k	10k
	1.25±0.20	-	-	3k	-
1206(3216)	0.80±0.10	4k	15k	-	-
	0.95±0.10	-	-	3k	10k
	1.25±0.10	-	-	3k	10k
	1.60±0.20	-	-	2k	-
1210(3225)	0.95±0.10	-	-	3k	10k
	1.25±0.10	-	-	3k	10k
	1.60±0.20	-	-	2k	-
	2.50±0.30	-	-	1k	-
1808(4520)	1.25±0.10	-	-	2k	-
	1.60±0.20	-	-	2k	-
	2.00±0.20	-	-	1k	-
1812(4532)	1.25±0.10	-	-	1k	-
	1.60±0.20	-	-	1k	-
	2.00±0.20	-	-	1k	-
	2.50±0.30	-	-	0.5k	-
1825(4563)	1.60±0.20	-	-	1k	-
	2.00±0.20	-	-	1k	-
	2.50±0.30	-	-	0.5k	-
	2.80±0.30	-	-	0.5k	-
2211(5728)	1.60±0.20	-	-	1k	-
	2.00±0.20	-	-	1k	-
	2.50±0.30	-	-	0.5k	-
	2.80±0.30	-	-	0.5k	-
2220(5750)	1.60±0.20	-	-	1k	-
	2.00±0.20	-	-	1k	-
	2.50±0.30	-	-	0.5k	-
	2.80±0.30	-	-	0.5k	-
2225(5763)	1.60±0.20	-	-	1k	-
	2.00±0.20	-	-	1k	-
	2.50±0.30	-	-	0.5k	-
	2.80±0.30	-	-	0.5k	-

Unit : pcs

Prosperity Dielectrics Co., Ltd.

9. PACKAGE DIMENSION AND QUANTITY

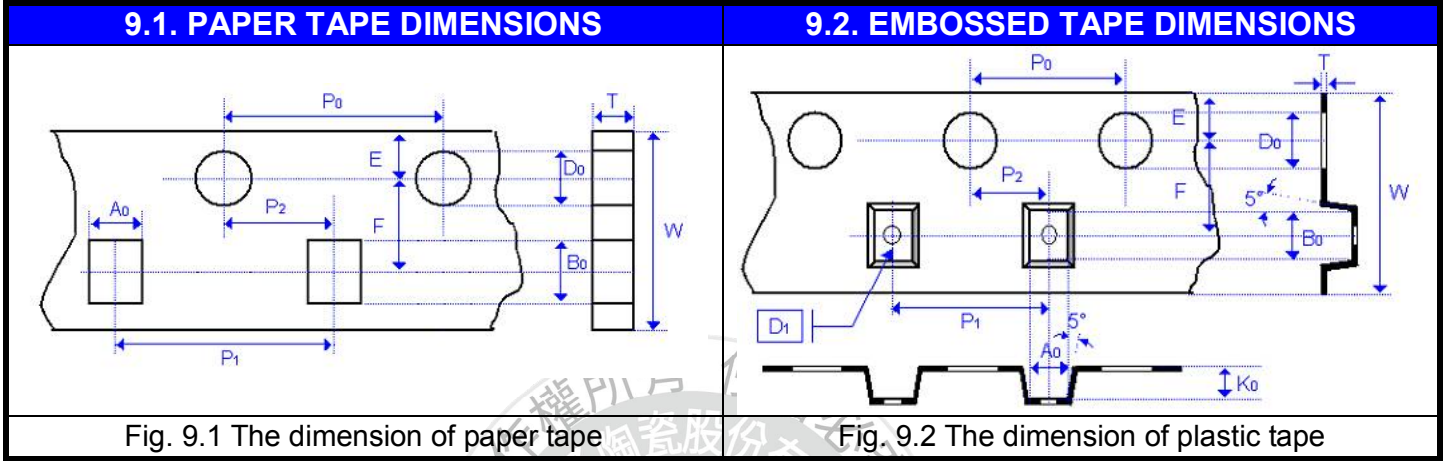

Fig. 9.1 The dimension of paper tape

Fig. 9.2 The dimension of plastic tape

Size	0603		0805		1206		
Chip Thickness	0.80±0.07	0.80 +0.15/-0.1	0.80±0.10	1.25±0.10 1.25±0.20	0.80±0.10	0.95±0.10 1.25±0.10	1.60±0.20 1.60+0.3/-0.1
A ₀	1.00 +0.05/-0.10	1.02 +0.05/-0.10	1.50±0.10	<1.65	2.00±0.10	<2.00	<2.00
B ₀	1.80±0.10	1.80±0.10	2.30±0.10	<2.40	3.50±0.10	<3.60	<3.70
T	0.95±0.05	0.97±0.05	0.95±0.05	0.23±0.05	0.95±0.05	0.23±0.05	0.23±0.05
K ₀	-	-	-	<2.50	-	<2.50	<2.50
W	8.00±0.10	8.00±0.10	8.00±0.10	8.00±0.10	8.00±0.10	8.00±0.10	8.00±0.10
P ₀	4.00±0.10	4.00±0.10	4.00±0.10	4.00±0.10	4.00±0.10	4.00±0.10	4.00±0.10
10xP ₀	40.00±0.20	40.00±0.20	40.00±0.20	40.00±0.20	40.00±0.20	40.00±0.20	40.00±0.20
P ₁	4.00±0.10	4.00±0.10	4.00±0.10	4.00±0.10	4.00±0.10	4.00±0.10	4.00±0.10
P ₂	2.00±0.05	2.00±0.05	2.00±0.05	2.00±0.05	2.00±0.05	2.00±0.05	2.00±0.05
D ₀	1.55±0.05	1.55±0.05	1.55±0.05	1.50 +0.10/-0	1.55±0.05	1.50 +0.10/-0	1.50 +0.10/-0
D ₁	-	-	-	1.00±0.10	-	1.00±0.10	1.00±0.10
E	1.75±0.05	1.75±0.05	1.75±0.05	1.75±0.10	1.75±0.10	1.75±0.10	1.75±0.10
F	3.50±0.05	3.50±0.05	3.50±0.05	3.50±0.05	3.50±0.05	3.50±0.05	3.50±0.05
Unit :	mm	mm	mm	mm	mm	mm	mm

Size	1210		1808		1812	
Chip Thickness	0.95±0.10 1.25±0.10 1.60±0.20	2.50±0.30	1.25±0.10 1.60±0.20	2.00±0.20	1.25±0.10 1.60±0.20 2.00±0.20	2.50±0.30
A ₀	<3.05	<3.10	<2.50	<2.50	<3.90	<3.90
B ₀	<3.80	<4.00	<5.30	<5.30	<5.30	<5.30
T	0.23±0.05	0.23±0.05	0.25±0.05	0.25±0.05	0.25±0.05	0.25±0.05
K ₀	<2.50	<3.50	<2.50	<2.50	<2.50	<3.00
W	8.00±0.10	8.00±0.10	12.00±0.20	12.00±0.20	12.00±0.20	12.00±0.20
P ₀	4.00±0.10	4.00±0.10	4.00±0.10	4.00±0.10	4.00±0.10	4.00±0.10
10xP ₀	40.00±0.20	40.00±0.20	40.00±0.20	40.00±0.20	40.00±0.20	40.00±0.20
P ₁	4.00±0.10	4.00±0.10	4.00±0.10	4.00±0.10	8.00±0.10	8.00±0.10
P ₂	2.00±0.05	2.00±0.05	2.00±0.05	2.00±0.05	2.00±0.05	2.00±0.05

D₀	1.50 +0.10/-0	1.50 +0.10/-0	1.50 +0.10/-0	1.50 +0.10/-0	1.50 +0.10/-0	1.50 +0.10/-0
D₁	1.00±0.10	1.00±0.10	1.50±0.10	1.50±0.10	1.50±0.10	1.50±0.10
E	1.75±0.10	1.75±0.10	1.75±0.10	1.75±0.10	1.75±0.10	1.75±0.10
F	3.50±0.05	3.50±0.05	5.50±0.05	5.50±0.05	5.50±0.05	5.50±0.05
Unit :	mm	mm	mm	mm	mm	mm

Prosperity Dielectrics Co., Ltd.

9. PACKAGE DIMENSION AND QUANTITY

Size	1825		2211		2220		2225	
Chip Thickness	1.60±0.20 2.00±0.20	2.50±0.30	1.60±0.20 2.00±0.20	2.50±0.30	1.40±0.15 1.60±0.20 2.00±0.20	2.50±0.30	1.60±0.20 2.00±0.20	2.50±0.30
A₀	<6.80	<6.80	<3.30	<3.30	<5.80	<5.80	<6.80	<6.80
B₀	<5.30	<5.30	<6.50	<6.50	<6.50	<6.50	<6.50	<6.50
T	0.30±0.10	0.30±0.10	0.30±0.10	0.30±0.10	0.30±0.10	0.30±0.10	0.30±0.10	0.30±0.10
K₀	<2.50	<3.10	<2.50	<3.10	<2.50	<3.10	<2.50	<3.10
W	12.00±0.20	12.00±0.20	12.00±0.20	12.00±0.20	12.00±0.20	12.00±0.20	12.00±0.20	12.00±0.20
P₀	4.00±0.10	4.00±0.10	4.00±0.10	4.00±0.10	4.00±0.10	4.00±0.10	4.00±0.10	4.00±0.10
10xP₀	40.00±0.20	40.00±0.20	40.00±0.20	40.00±0.20	40.00±0.20	40.00±0.20	40.00±0.20	40.00±0.20
P₁	8.00±0.10	8.00±0.10	8.00±0.10	8.00±0.10	8.00±0.10	8.00±0.10	8.00±0.10	8.00±0.10
P₂	2.00±0.05	2.00±0.05	2.00±0.05	2.00±0.05	2.00±0.05	2.00±0.05	2.00±0.05	2.00±0.05
D₀	1.50 +0.10/-0	1.50 +0.10/-0	1.50 +0.10/-0	1.50 +0.10/-0	1.50 +0.10/-0	1.50 +0.10/-0	1.50 +0.10/-0	1.50 +0.10/-0
D₁	1.50±0.10	1.50±0.10	1.50±0.10	1.50±0.10	1.50±0.10	1.50±0.10	1.50±0.10	1.50±0.10
E	1.75±0.10	1.75±0.10	1.75±0.10	1.75±0.10	1.75±0.10	1.75±0.10	1.75±0.10	1.75±0.10
F	5.50±0.05	5.50±0.05	5.50±0.05	5.50±0.05	5.50±0.05	5.50±0.05	5.50±0.05	5.50±0.05
Unit :	mm	mm	mm	mm	mm	mm	mm	mm

9.3. REEL DIMENSIONS

Size	0603, 0805, 1206, 1210		1808, 1812, 1825, 2211, 2220, 2225
Reel size	7"	13"	7"
C	13.0 +0.5/-0.2	13.0 +0.7/-0.3	13.0 +0.5/-0.2
W₁	8.4 +1.5/-0	8.4 +2.0/-0	12.4 +2.0/-0
A	178.0 ±0.10	330.0 ±1.0	178.0 ±0.10
N	60.0 +1.0/-0	100 ±1.0	60.0 +1.0/-0

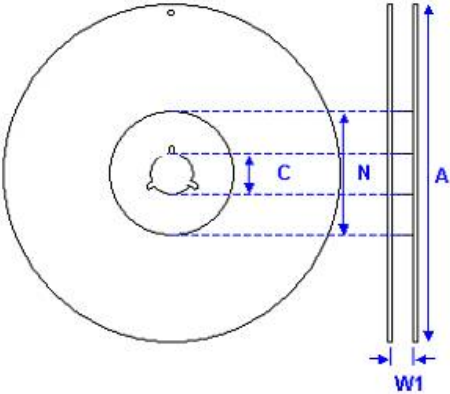

Fig. 9.3 The dimension of reel

Prosperity Dielectrics Co., Ltd.

10. APPLICATION NOTES

STORAGE

To prevent the damage of solderability of terminations, the following storage conditions are recommended :

Indoors under 5 ~ 40°C and 20% ~ 70% RH.

No harmful gases containing sulfuric acid, ammonia, hydrogen sulfide or chlorine.

Packaging should not be opened until the capacitors are required for use. If opened, the pack should be re-sealed as soon as is practicable. Taped product should be stored out of direct sunlight, which might promote deterioration in tape or adhesion performance. The product is recommended to be used within 12 months after shipment and checked the solderability before use.

HANDLING

Chip capacitors are dense, hard, brittle, and abrasive materials. They are liable to suffer mechanical damage, in the form of cracks or chips. Chip Capacitors should be handled with care to avoid contamination or damage. To use vacuum or plastic tweezers to pick up or plastic tweezers is recommended for manual placement. Tape and reeled packages are suitable for automatic pick and placement machine.

PREHEAT

In order to minimize the risk of thermal shock during soldering, a carefully controlled preheat is required. The rate of preheat should not exceed 3°C per second.

SOLDERING

Use middy activated rosin RA and RMA fluxes do not use activated flux. The amount of solder in each solder joint should be controlled to prevent the damage of chip capacitors caused by the stress between solder, chips, and substrate.

a.) Hand soldering :

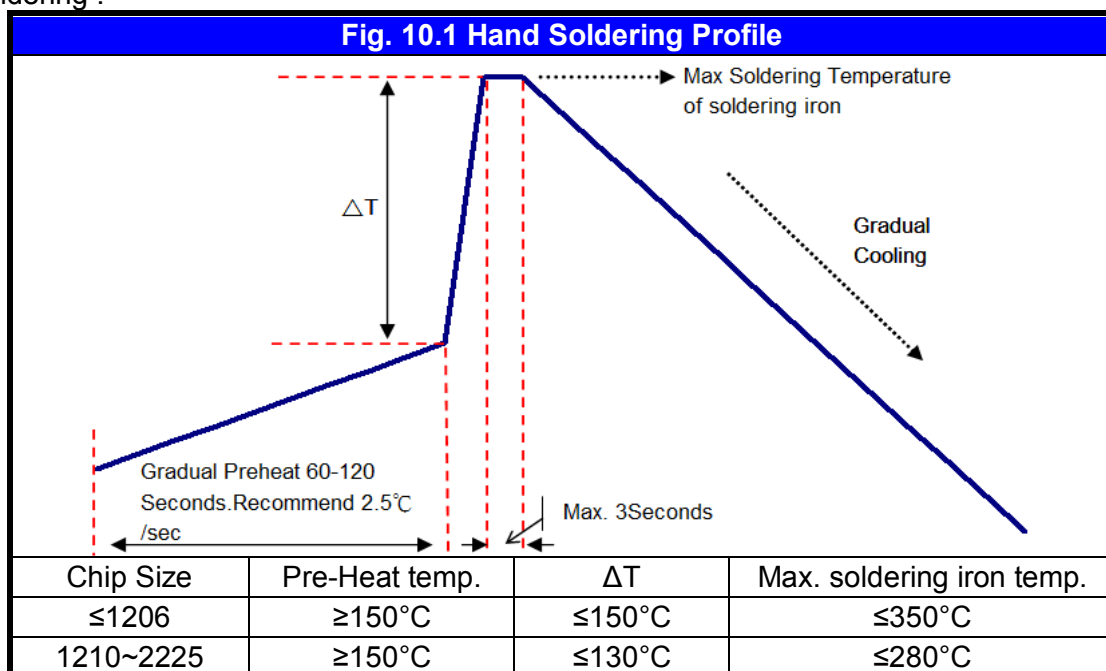

* Soldering iron tip diameter ≤ 1.0 mm and wattage max. 20W.

* The Capacitors shall be pre-heated and that the temperature gradient between the devices and the tip of the Specification No. : FV-000-001-22

soldering iron.

- * The required amount of solder shall be melted on the soldering tip.
- * The tip of iron should not contact the ceramic body directly.
- * The Capacitors shall be cooled gradually at room temperature after soldering.
- * Forced air cooling is not allowed.



10. APPLICATION NOTES

b.) Reflow soldering :

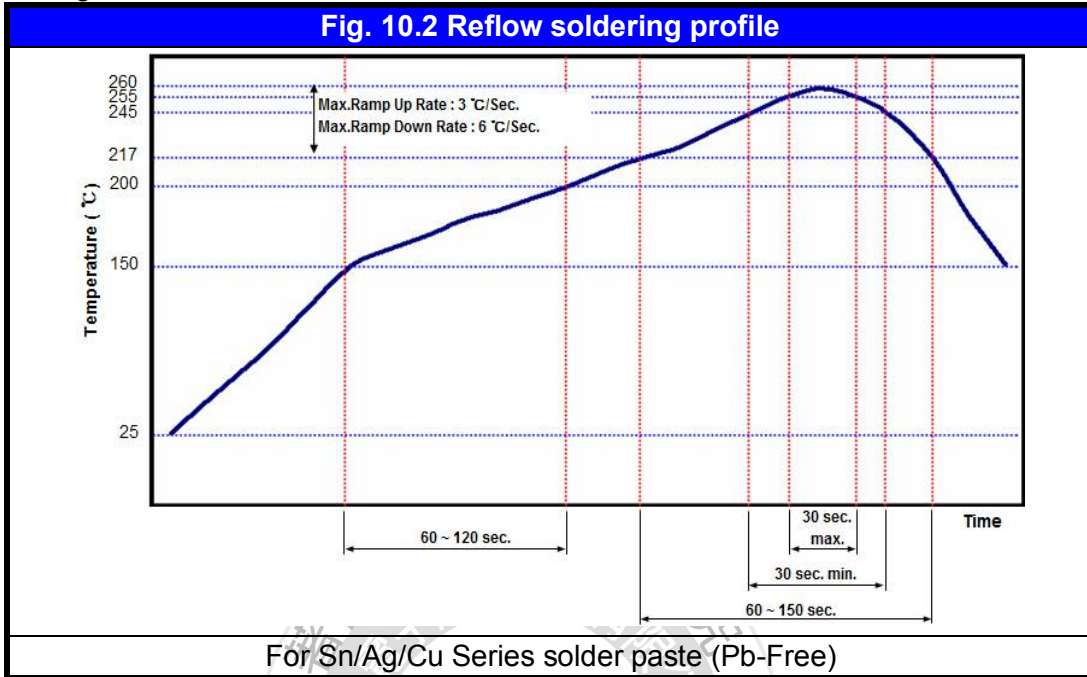

c.) Wave soldering :

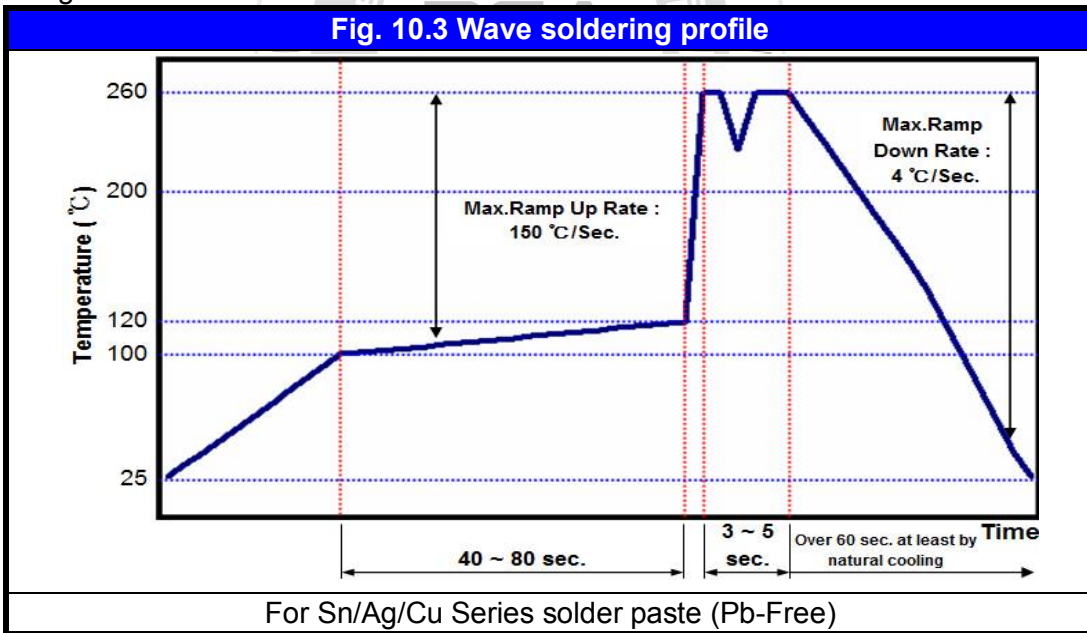

Soldering conditions :

Class I :

Size Inch (mm)	Temper. Char.	Capacitance	Condition	
			Wave	Reflow
≤0402 (1005)	Class I - C0G	All	X	O
0603 (1608)	Class I - C0G	All	O	O
0805 (2012)	Class I - C0G	All	O	O
1206 (3216)	Class I - C0G	All	O	O
≥1210 (3225)	Class I - C0G	All	X	O

10. APPLICATION NOTES

Soldering conditions :
 Class II :

Size Inch (mm)	Temper. Cher.	Capacitance	Condition	
			Wave	Reflow
≤0402 (1005)	Class II - X7R	All	X	O
0603 (1608)	Class II - X7R	Cap. <2.2μF	O	O
		Cap. ≥2.2μF	X	O
0805 (2012)	Class II - X7R	Cap. <4.7μF	O	O
		Cap. ≥4.7μF	X	O
1206 (3216)	Class II - X7R	Cap. <4.7μF	O	O
		Cap. ≥4.7μF	X	O
≥1210 (3225)	Class II - X7R	All	X	O

Soldering height :

The solder climbing minimum height is suggesting to 25% of chip thickness or 500um whichever is less.
 (Reference from IPC-610E)

COOLING

After soldering, cool the chips and the substrate gradually to room temperature. Natural cooling in air is recommended to minimize stress in the solder joint.

CLEANING

All flux residues must be removed by using suitable electronic-grade vapor-cleaning solvents to eliminate contamination that could cause electrolytic surface corrosion. Good results can be obtained by using ultrasonic cleaning of the solvent. The choice of the proper system is depends upon many factors such as component mix, flux, and solder paste and assembly method. The ability of the cleaning system to remove flux residues and contamination from under the chips is very important.

Surface coating products are not suitable cleaning/washing by solvent

X-ON Electronics

Largest Supplier of Electrical and Electronic Components

Click to view similar products for [Multilayer Ceramic Capacitors MLCC - SMD/SMT](#) category:

Click to view products by [Prosperity](#) manufacturer:

Other Similar products are found below :

[M39014/02-1218V](#) [M39014/02-1225V](#) [M39014/22-0631](#) [D55342E07B523DR-T/R](#) [NIN-FB391JTRF](#) [NIN-FC2R7JTRF](#)
[NMC0402NPO220J50TRPF](#) [NMC0402X5R105K6.3TRPF](#) [NMC0402X5R224K6.3TRPF](#) [NMC0402X7R103J25TRPF](#)
[NMC0402X7R392K50TRPF](#) [NMC0603NPO101F50TRPF](#) [NMC0603NPO201J50TRPF](#) [NMC0603NPO330G50TRPF](#)
[NMC0603NPO331F50TRPF](#) [NMC0603X5R475M6.3TRPF](#) [NMC0603X7R333K16TRPF](#) [NMC0805NPO220J100TRPF](#)
[NMC0805NPO820J50TRPF](#) [NMC0805X7R224K25TRPF](#) [NMC1206X7R102K50TRPF](#) [NMC1206X7R106K10TRPLPF](#) [NMC-](#)
[H0805X7R472K250TRPF](#) [C1608C0G2A221J](#) [C1608X7R1E334K](#) [C2012C0G2A472J](#) [2220J2K00562KXT](#) [CCR06CG153FSV](#)
[CDR04BX104AKSR](#) [CDR33BX104AKUR](#) [CDR33BX683AKUS](#) [CGA3E1X7R1C684K](#) [CL10C0R8BB8ANNC](#) [M55342H06B20G0R-T/R](#)
[C1005X5R0G225M](#) [C2012X7R2E223K](#) [C3216C0G2J272J](#) [D55342E07B35E7R-T/R](#) [CDR34BX563BKUS](#) [CDR34BX563BKWS](#)
[NMC0402NPO220F50TRPF](#) [NMC0402X7R562J25TRPF](#) [NMC0603NPO102J25TRPF](#) [NMC1206X7R332K50TRPF](#) [NMC-](#)
[P1206X7R104K250TRPLPF](#) [726632-1](#) [CGA6M3X7R1H225K](#) [CGA5L2X7R2A105K](#) [CGA3E2X8R1H223K](#) [CDR33BX823AKUR\M500](#)