

信昌電子陶瓷股份有限公司  
Prosperity Dielectrics Co., Ltd.

No.566-1, Gaoshi Rd., Lujhu, Yangmei Dist., Taoyuan City 32668, Taiwan, R.O.C.  
Tel. : +886-3-4753355 Fax : +886-3-4854959

**SPECIFICATION FOR APPROVAL**

DATE : 2021/1/12

CUSTOMER : \_\_\_\_\_

PART NAME : Thick Film High Voltage Chip Resistor

CUSTOMER'S DWG. NO. : \_\_\_\_\_

CUSTOMER'S PART NO. : \_\_\_\_\_

PDC PART NO. : **FVF SERIES APPROVED**

DESCRIPTION : \_\_\_\_\_

ACTION	"V"	CUSTOMER'S SIGNATURE	NOTE
RESULT			
FULL APPROVED			
CONDITIONAL APPROVED			
REJECTED			

OUR ACTION	SIGNATURE
PREPARED By	<i>Jenny Tseng</i>
CHECKED By	<i>Tony Chou</i>
APPROVED By	<i>Byron Tsai</i>

CUSTOMER SIGNATURE FOR ACCEPTANCE

---

1. Features .....	2
2. Applications.....	2
3. Dimension and construction .....	2
4. Power Derating Curve .....	3
5. Rating .....	4
6. Part Number .....	4
7. Resistance Marking / Soldering .....	5
8. Reliability Performance.....	7
9. Packing .....	10
9.1 Peel Strength of Top Cover Tape.....	10
9.2 Tape Packaging Dimensions.....	10
9.3 Reel Dimensions.....	11
10. Storage / Handling .....	11
11. Appendix .....	12

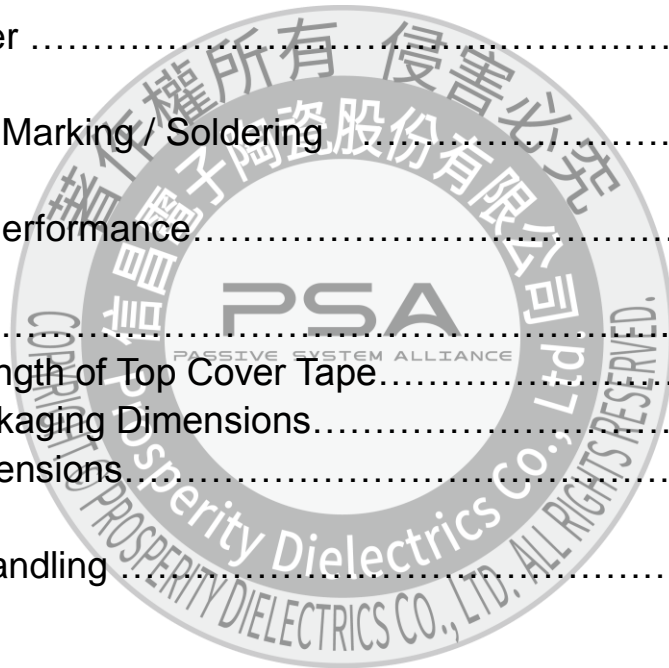

### 1. Features

- Special materials and design for higher working voltage required.
- Superior surge ability than general purpose series.
- Compatible with flow and reflow soldering.
- Suitable for lead free soldering.
- Max. Voltage coefficient resistance below 300ppm.
- Meet AEC-Q200, RoHS compliant & Halogen Free.

### 2. Applications

- Power supply.
- Automotive industry.
- Measurement instrument.
- Medical equipment.

### 3. Dimension and Construction

#### 3.1 R value $\geq 100K\Omega$

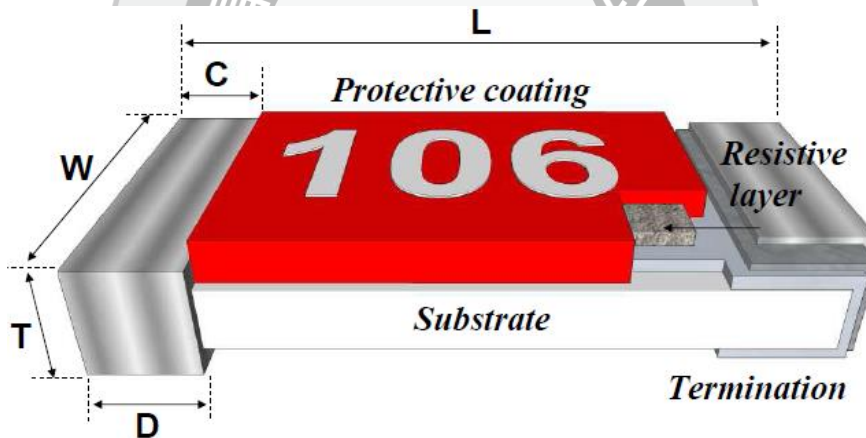

Unit : mm

Type	L	W	C	D	T
FVF03	1.60±0.10	0.80±0.10	0.30±0.20	0.30±0.20	0.45±0.10
FVF05	2.00±0.10	1.25±0.10	0.40±0.20	0.40±0.20	0.50±0.10
FVF06	3.10±0.10	1.60±0.10	0.50±0.20	0.50±0.20	0.55±0.10
FVF20	5.00±0.20	2.50±0.20	0.65±0.25	0.60±0.25	0.60±0.10
FVF25	6.40±0.20	3.20±0.20	0.65±0.25	0.90±0.25	0.60±0.15

**3.2 R value <100KΩ**

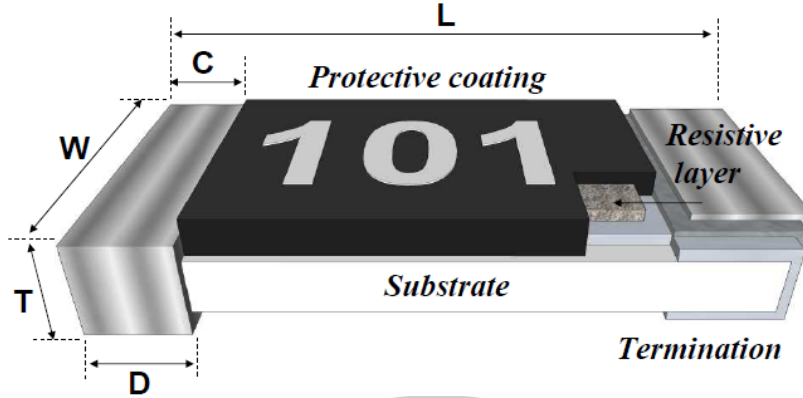

Unit : mm

Type	L	W	C	D	T
FVF03	1.60±0.10	0.80±0.10	0.30±0.20	0.30±0.20	0.45±0.10
FVF05	2.00±0.10	1.25±0.10	0.40±0.20	0.40±0.20	0.50±0.10
FVF06	3.10±0.10	1.60±0.10	0.50±0.25	0.50±0.25	0.55±0.10
FVF20	5.00±0.20	2.50±0.20	0.65±0.25	0.60±0.25	0.60±0.10
FVF25	6.40±0.20	3.10±0.20	0.60±0.25	1.80±0.25	0.60±0.15

**4. Power Derating Curve**

Operating Temperature Range: -55 to +155°C

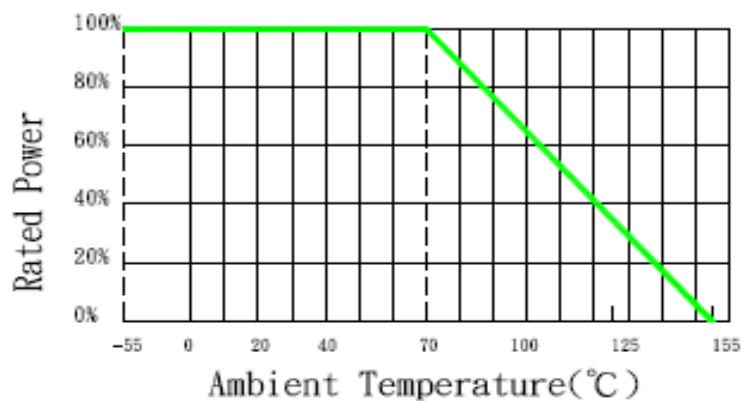

# FVF series. (AEC-Q200) High Voltage Series Thick-film Lead Free Chip Resistors

## 5. Rating

Type	Size	Power Rating at 70°C	Max. RCWV	Max. Overload Voltage	Resistance Tolerance	Temperature Coefficient (ppm/°C)	Resistance Range		Standard Resistance Values
							Min.	Max.	
FVF03	0603	1/10W	200V	400V	±1%(F)	±100	47Ω	10MΩ	E96/E24
					±5%(J)	±200	100KΩ	22MΩ	E24
FVF05	0805	1/8W	400V	800V	±1%(F)	±100	47Ω	10MΩ	E96/E24
					±5%(J)	±200	100KΩ	22MΩ	E24
FVF06	1206	1/4W	800V	1600V	±1%(F)	±100	47Ω	10MΩ	E96/E24
					±1%(F)	±200	11MΩ	22MΩ	E24
					±5%(J)	±200	47Ω	100MΩ	E24
FVF20	2010	1/2W	2000V	3000V	±1%(F)	±100	47Ω	10MΩ	E96/E24
					±1%(F)	±200	11MΩ	22MΩ	E24
					±5%(J)	±200	47Ω	100MΩ	E24
FVF25	2512	1W	3000V	4000V	±1%(F)	±100	47Ω	10MΩ	E96/E24
					±1%(F)	±200	11MΩ	22MΩ	E24
					±5%(J)	±200	47Ω	100MΩ	E24

Note : RCWV =  $(P \times R)^{1/2}$  or Max. RCWV listed above, whichever is lower.

RCWV : Working Voltage (V) , P : Rated Power (W) , R : Resistance Value (Ω)

## 6. Part Number

Type	Size	Tolerance	Packing	Watt	R Value (GM)	TCR	Special Code
<b>FVF</b>	<b>03</b> :0603	<b>F</b> :±1%	<b>Paper Tape :</b> <b>0603.0805.1206</b> <b>T</b> : 5Kpcs <b>V</b> : 10Kpcs <b>W</b> : 20Kpcs <b>Plastic Tape :</b> <b>2010.2512</b> <b>P</b> : 4Kpcs <b>X</b> : 8Kpcs <b>Y</b> : 16Kpcs	: As Rating Info	<b>XXXX</b> <b>XXX</b> <b>±5%:</b> 3 digits <b>±1%:</b> 4 digits	: As Rating Info	<b>" Null "</b> : Standard <b>M</b> : Meet AEC-Q200
	<b>05</b> :0805	<b>J</b> :±5%					
	<b>06</b> :1206						
	<b>20</b> :2010						
	<b>25</b> :2512						

Example :

**FVF25FP-1004-M**

→ 2512 size, tolerance 1%, plastic tape, 1W, 1 MΩ, Aec-Q200.

**FVF06JT-104**

→ 1206 size, tolerance 5%, paper tape, 1/4W, 100 KΩ, standard.

**7. Marking/Soldering**

**R value** ≥ 100KΩ, Overcoating Color is “Red”.

**R value** < 100KΩ, Overcoating Color is “Black”.

E24 ±5% : 3 Digits marking to identify the resistance value

0603/0805/1206/2010/2512

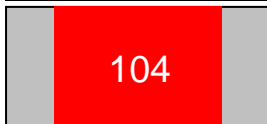

104 →  $10 \times 10^4 = 100 \text{ K}\Omega$

E24/E96 ±1% : 4 Digits marking to identify the resistance value

0805/1206/2010/2512



1001 →  $100 \times 10^1 = 1 \text{ K}\Omega$

E24 ±1% : 3 Digits marking to identify the resistance value

0603

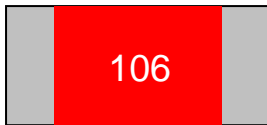

106 →  $10 \times 10^6 = 10 \text{ M}\Omega$

E96 ±1% : 3 Digits marking to identify the resistance value

0603

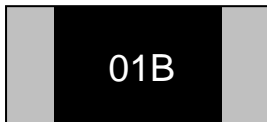

01B → Refer 0603 marking table = 1 KΩ

**Soldering Reference :**

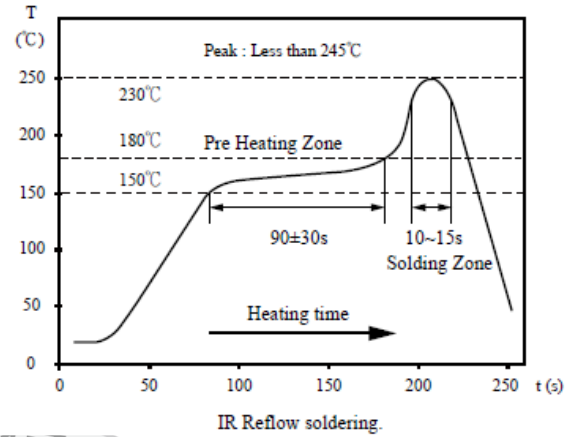
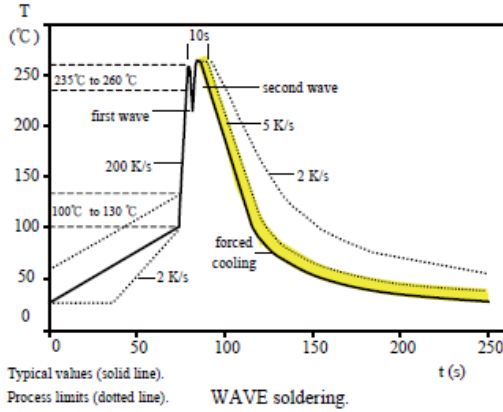

**Recommend Solder Pad Dimensions :**

Type	W	D	L
FVF03	0.90	1.00	3.00
FVF05	1.30	1.15	3.50
FVF06	1.80	1.30	4.70
FVF20	3.00	1.50	6.80
FVF25	3.70	1.60	7.60
FVF25 <100KΩ	3.70	2.45	7.60

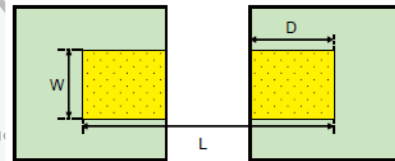

Unit:mm

## 8. Reliability Performance (AEC-Q200)

Test Item	Specification	Test Method (AEC-Q200. IEC 60115)
<b>*DC Resistance</b>	F : $\pm 1\%$ ; J : $\pm 5\%$	<b>AEC-Q200 TABLE 7.1</b> IEC 60115-1 / JIS C 5201-1 , Clause 4.5 Measure the resistance Value.
<b>High Temperature Exposure (Storage)</b>	J : $\Delta R \leq \pm(3\%+0.1\Omega)$ F : $\Delta R \leq \pm(1\%+0.05\Omega)$	<b>AEC-Q200 TABLE 7.3</b> 1000 hrs. @ T=125°C. Unpowered. Measurement at 24 $\pm$ 2 hours after test conclusion.
<b>*Temperature Cycling</b>	$\Delta R \leq \pm(1\%+0.1\Omega)$ No mechanical damage.	<b>AEC-Q200 TABLE 7.4</b> 1000 Cycles (-55°C to +125°C). Measurement at 24 $\pm$ 4 hours after test conclusion.
<b>Moisture Resistance</b>	$\Delta R \leq \pm(1\%+0.1\Omega)$	<b>AEC-Q200 TABLE 7.6</b> Test 65°C/80~100%RH/10Cycles. Measurement at 24 $\pm$ 2 hours after test conclusion. (t=24hrs/cycle).
<b>Biased Humidity</b>	J : $\Delta R \leq \pm(5\%+0.1\Omega)$ F : $\Delta R \leq \pm(3\%+0.05\Omega)$ VCR within the spec.	<b>AEC-Q200 TABLE 7.7</b> 1000 hours 85°C/85%RH. 10% of operating power. Measurement at 24 $\pm$ 2 hours after test conclusion.
<b>Operational Life</b>	J : $\Delta R \leq \pm(5\%+0.1\Omega)$ F : $\Delta R \leq \pm(3\%+0.05\Omega)$ VCR within the spec.	<b>AEC-Q200 TABLE 7.8</b> Test 1000hr @ TA=125°C at specified rated power. Measurement at 24 $\pm$ 2 hours after test conclusion.
<b>External Visual</b>	No visual damage and refer PDC marking code.	<b>AEC-Q200 TABLE 7.9</b> Inspect device construction, marking and workmanship.
<b>Physical Dimension</b>	Within the spec.	<b>AEC-Q200 TABLE 7.10</b> Verify physical dimensions to the applicable device detail specification.



# FVF series. (AEC-Q200) High Voltage Series Thick-film Lead Free Chip Resistors

<b>Mechanical Shock</b>	Within product specification tolerance and no visible damage.	<b>AEC-Q200 TABLE 7.13</b> Test Peak value:100g's,Wave:Hail-sine, Duration:6ms,Velocity:12.3ft/sec.
<b>Vibration</b>	No mechanical damage.	<b>AEC-Q200 TABLE 7.14</b> 5 g's for 20 min., 12 cycles each of 3 orientations. Test from 10-2000 Hz.
<b>*Resistance to Solder Heat</b>	$\Delta R \leq \pm(1\% + 0.1\Omega)$ No mechanical damage.	<b>AEC-Q200 TABLE 7.15</b> Solder dipping @ 270°C±5°C for 10sec.±1sec.
<b>Thermal Shock</b>	J : $\Delta R \leq \pm(1\% + 0.1\Omega)$ F : $\Delta R \leq \pm(0.5\% + 0.05\Omega)$ No mechanical damage	<b>AEC-Q200 TABLE 7.16</b> -55 to 155°C/ dwell time 15min/ Max transfer time 20sec/ 300cycles.
<b>ESD</b>	$\Delta R \leq \pm(1\% + 0.1\Omega)$ No mechanical damage.	<b>AEC-Q200-002</b> Test contact min. 1KV.
<b>*Solder Ability</b>	Over 95% of termination must be covered with solder.	<b>AEC-Q200 TABLE 7.18</b> a)Baking 155°C 4H, dipping 235°C 5s b)Steam 1H, dipping 215°C 5s c)Steam 1H, dipping 260°C 7s
<b>Flammability</b>	Refer UL-94.	<b>AEC-Q200 TABLE 7.20</b> UL-94 V-0 or V-1 are acceptable
<b>*Board Flex</b>	J : $\Delta R \leq \pm(1\% + 0.1\Omega)$ F : $\Delta R \leq \pm(0.5\% + 0.05\Omega)$ No mechanical damage.	<b>AEC-Q200 TABLE 7.21</b> Bending 2mm 2512.2010.1210.1206, 3mm 0805.0603.
<b>Terminal Strength</b>	No mechanical damage	<b>AEC-Q200 TABLE 7.22</b> Force 1 Kg for 60 seconds.
<b>*Short Time Overload</b>	J : $\Delta R \leq \pm(2\% + 0.1\Omega)$ F : $\Delta R \leq \pm(1\% + 0.1\Omega)$	<b>IEC 60115-1, Clause 4.13</b> 5 × Rated power for 5 seconds
<b>*Load Life Humidity</b>	J : $\Delta R \leq \pm(3\% + 0.1\Omega)$ F : $\Delta R \leq \pm(1\% + 0.1\Omega)$	<b>IEC 60115-1, Clause 4.24</b> 40±2°C with relative humidity 90% ~ 95% D.C. rated voltage for 1.5 hours ON 30 minutes OFF. Cycle repeated 1000 hours.



## 9. PACKAGING

### 9.1 Peel Strength of Top Cover Tape

The peel speed shall be about 300 mm/min

The peel force of top cover tape shall between 0.1 to 0.7N

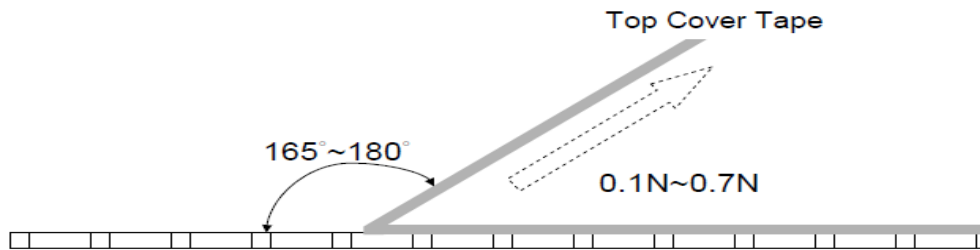

### 9.2 Tape Packaging Dimensions

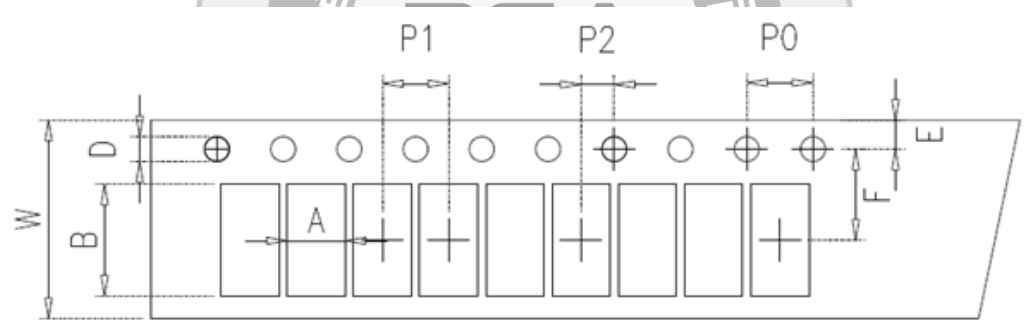

Size	A	B	W	F	E	P1	P2	P0	D
0603	1.10±0.20	1.90±0.20	8.00±0.30	3.50±0.05	1.75±0.10	4.00±0.10	2.00±0.05	4.00±0.10	1.50+0.10/-0
0805	1.65±0.20	2.40±0.20	8.00±0.30	3.50±0.05	1.75±0.10	4.00±0.10	2.00±0.05	4.00±0.10	1.50+0.10/-0
1206	2.00±0.20	3.60±0.20	8.00±0.30	3.50±0.05	1.75±0.10	4.00±0.10	2.00±0.05	4.00±0.10	1.50+0.10/-0
2010	2.80±0.20	5.50±0.20	12.00±0.30	5.50±0.05	1.75±0.10	4.00±0.10	2.00±0.05	4.00±0.10	1.50+0.10/-0
2512	3.50±0.20	6.70±0.20	12.00±0.30	5.50±0.05	1.75±0.10	4.00±0.10	2.00±0.05	4.00±0.10	1.50+0.10/-0

unit:mm

unit : mm

### 9.3 Reel Dimensions

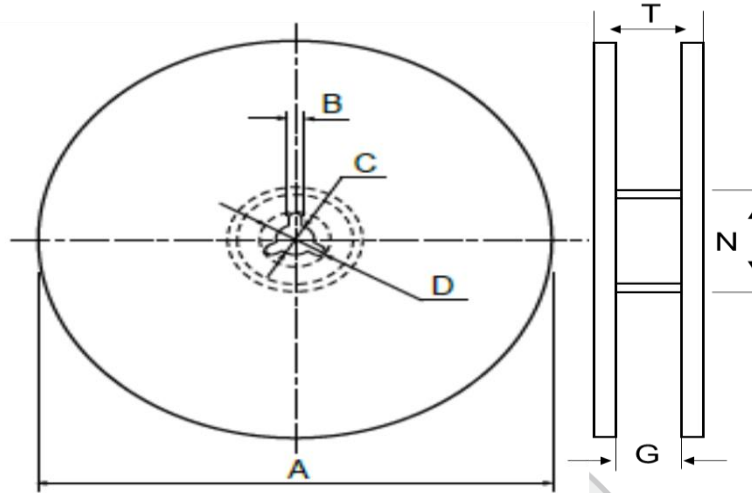

Size	Packaging Q'ty	A	N	C	D	B	G	T
0603 0805 1206	5kpcs/Reel	178.0±2.0	60.0±0.5	13.0±0.5	20(Min.)	2.0±0.5	10.0±1.5	14.9max.
	10kpcs/Reel	254.0±2.0	100.0±1.0	13.5±0.5	20(Min.)	2.0±0.5	10.0±1.5	14.9max.
	20kpcs/Reel	330.0±2.0	100.0±1.0	13.5±0.5	20(Min.)	2.0±0.5	10.0±1.5	14.9max.
2010 2512	4kpcs/Reel	178.0±2.0	60.0±0.5	13.0±0.5	20(Min.)	2.0±0.5	13.8±1.5	16.7max.
	8kpcs/Reel	254.0±2.0	100.0±0.5	13.5±0.5	20(Min.)	2.0±0.5	13.8±1.5	20.0max.
	16kpcs/Reel	330.0±2.0	100.0±1.0	13.5±0.5	20(Min.)	2.0±0.5	13.8±1.5	20.0max.

unit:mm

## 10. Storage & Handling

... Products are recommended to be used up within one year as ensured shelf life.

Check solder ability in case shelf life extension is needed.

... To store products with following condition:

Temperature:5 to 40°C ; Humidity: 20 to 70% relative humidity.

### Precaution for use :

The AEC-Q200 series resistors is mainly used on general automotive equipment without safety considerations.

Please contact our company in advanced if you intend to use resistor for designing the equipment which may

damage itself and the safety of third party. If necessary, please consider to add the protect circuit in devising

process and obtaining fully safety evaluation. The contents of the acknowledgment is only used for our parent

company, marketing subsidiaries and official marketing agents who purchase our products. Not applicable for the

other nonofficial channels.

## Appendix

■ 0603 1% Marking Table (Table 1)

Code	E48	E96	Code	E48	E96	Code	E48	E96	Code	E48	E96
01	100	100	25	178	178	49	316	316	73	562	562
02		102	26		182	50		324	74		576
03	105	105	27	187	187	51	332	332	75	590	590
04		107	28		191	52		340	76		604
05	110	110	29	196	196	53	348	348	77	619	619
06		113	30		200	54		357	78		634
07	115	115	31	205	205	55	365	365	79	649	649
08		118	32		210	56		374	80		665
09	121	121	33	215	215	57	383	383	81	681	681
10		124	34		221	58		392	82		698
11	127	127	35	226	226	59	402	402	83	715	715
12		130	36		232	60		412	84		732
13	133	133	37	237	237	61	422	422	85	750	750
14		137	38		243	62		432	86		768
15	140	140	39	249	249	63	442	442	87	787	787
16		143	40		255	64		453	88		806
17	147	147	41	261	261	65	464	464	89	825	825
18		150	42		267	66		475	90		845
19	154	154	43	274	274	67	487	487	91	866	866
20		158	44		280	68		499	92		887
21	162	162	45	287	287	69	511	511	93	909	909
22		165	46		294	70		523	94		931
23	169	169	47	301	301	71	536	536	95	953	953
24		174	48		309	72		549	96		976

Code	A	B	C	D	E	F	G	H	X	Y	Z
Multiplier	10 <sup>0</sup>	10 <sup>1</sup>	10 <sup>2</sup>	10 <sup>3</sup>	10 <sup>4</sup>	10 <sup>5</sup>	10 <sup>6</sup>	10 <sup>7</sup>	10 <sup>-1</sup>	10 <sup>-2</sup>	10 <sup>-3</sup>

※ All product specification and data are subject to change without notice.

## X-ON Electronics

Largest Supplier of Electrical and Electronic Components

*Click to view similar products for [Thick Film Resistors - SMD category](#):*

*Click to view products by [Prosperity manufacturer](#):*

Other Similar products are found below :

[CR-05FL7--150R](#) [CR-05FL7--698K](#) [CR-12JP4--680R](#) [CRCW04021K20FKEE](#) [CRCW04028R20JNEE](#) [CRCW06032K10FKEC](#)  
[CRCW06036K80FKEE](#) [M55342K03B499DRS6](#) [M55342K06B6E19RWL](#) [M55342K09B5D62RS6](#) [M55342M06B26E7RS3](#) [742C083750JTR](#)  
[MCR01MZPF1202](#) [MCR01MZPF1601](#) [MCR01MZPF1800](#) [MCR01MZPF6201](#) [MCR01MZPF9102](#) [MCR01MZPJ121](#) [MCR01MZPJ125](#)  
[MCR01MZPJ751](#) [MCR03EZHJ103](#) [MCR03EZPF2004](#) [MCR03EZPJ270](#) [MCR03EZPJ821](#) [MCR10EZPF1102](#) [MCR10EZPF2700](#)  
[MCR18EZPJ330](#) [RC1005F1152CS](#) [RC1005F1372CS](#) [RC1005F1912CS](#) [RC1005F2052CS](#) [RC1005F3011CS](#) [RC1005F471CS](#)  
[RC1005F4751CS](#) [RC1005F5621CS](#) [RC1005F6041CS](#) [RC1005J121CS](#) [RC1005J122CS](#) [RC1005J154CS](#) [RC1005J180CS](#) [RC1005J181CS](#)  
[RC1005J202CS](#) [RC1005J391CS](#) [RC1005J560CS](#) [RC1005J683CS](#) [RC1005J823CS](#) [RC1608F1022CS](#) [RC1608F333CS](#) [RC1608F3651CS](#)  
[RC1608F5110CS](#)