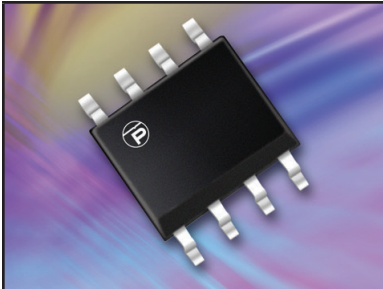


## 500 WATT LOW CAPACITANCE STEERING DIODE/TVS ARRAY



**SO-8 PACKAGE**

### DESCRIPTION

The PSRDAXx-4 Series are low capacitance multi-line steering diode/transient voltage suppressor arrays that provides board level protection for standard TTL and CMOS bus line applications against the damaging effects of ESD, tertiary lightning and switching transients.

The PSRDAXx-4 Series has a peak pulse power rating of 500 Watts for an 8/20 $\mu$ s waveshape. This device series meets the IEC 61000-4-2, IEC 61000-4-4 and IEC 61000-4-5 requirements.

### FEATURES

- Compatible with IEC 61000-4-2 (ESD): Air - 15kV, Contact - 8kV
- Compatible with IEC 61000-4-4 (EFT): 40A - 5/50ns
- Compatible with IEC 61000-4-5 (Surge): 24A, 8/20 $\mu$ s - Level 2(Line-Gnd) & Level 3(Line-Line)
- 500 Watts Peak Pulse Power per Line (tp = 8/20 $\mu$ s)
- Unidirectional Configuration
- Available in 3.3V, 5V, 12V & 15V
- Protects Up to Four I/O Ports
- Low Capacitance: 5pF per Diode
- RoHS Compliant
- REACH Compliant

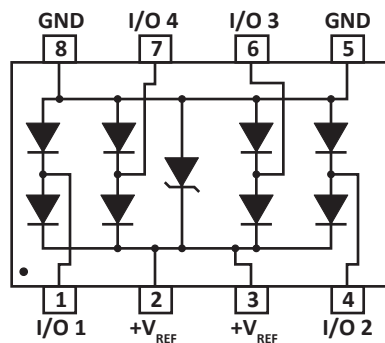
### APPLICATIONS

- Computer Interface Protection
- Ethernet - 10/100/1000 Base T
- Set-Top Box Protection
- Video Card

### MECHANICAL CHARACTERISTICS

- Molded JEDEC SO-8 Package
- Approximate Weight: 70 milligrams
- Lead-Free Pure-Tin Plating (Annealed)
- Solder Reflow Temperature:  
Pure-Tin - Sn, 100: 260-270°C
- 12mm Tape and Reel Per EIA Standard 481
- Flammability Rating UL 94V-0

### PIN CONFIGURATION



## TYPICAL DEVICE CHARACTERISTICS

## MAXIMUM RATINGS @ 25°C Unless Otherwise Specified

PARAMETER	SYMBOL	VALUE	UNITS
Peak Pulse Power (tp = 8/20μs) - See Figure 1	$P_{PP}$	500	Watts
Operating Temperature	$T_L$	-55 to 150	°C
Storage Temperature	$T_{STG}$	-55 to 150	°C
Continuous Power Dissipation	$P_{PC}$	1000	mW
Maximum Forward Voltage @ 10mA (Note 1)	$V_F$	1.1	Volts

## NOTES

1. Measured between pins 8 or 5 to 1, 2, 3, 4, 6 and 7.

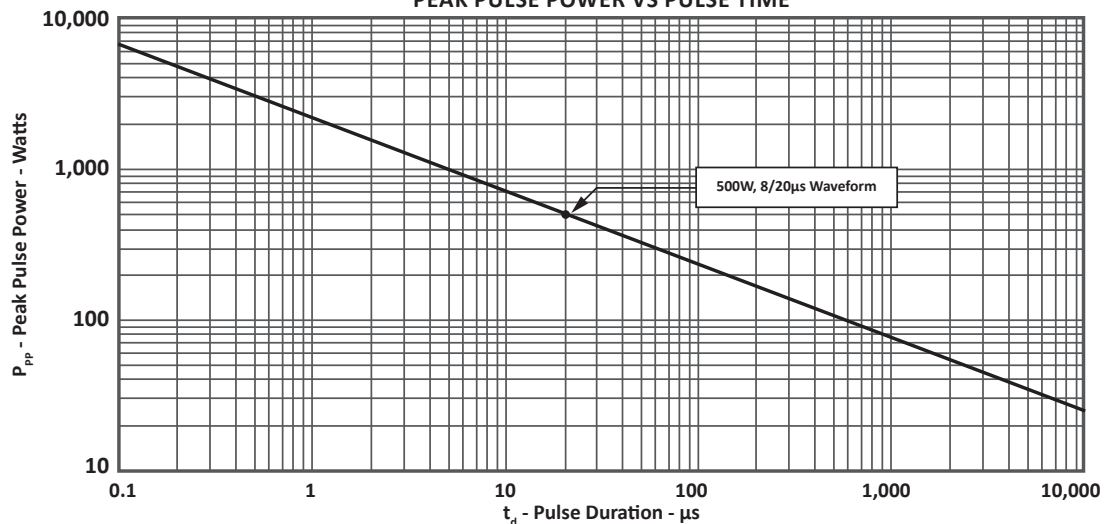
## ELECTRICAL CHARACTERISTICS PER LINE @ 25°C Unless Otherwise Specified

PART NUMBER	DEVICE MARKING	RATED STAND-OFF VOLTAGE $V_{WM}$ VOLTS	MINIMUM BREAKDOWN VOLTAGE @1mA $V_{(BR)}$ VOLTS	MAXIMUM CLAMPING VOLTAGE (Fig. 2) @ $I_P = 1A$ $V_C$ VOLTS	MAXIMUM LEAKAGE CURRENT @ $V_{WM}$ $I_D$ μA	MAXIMUM CAPACITANCE (Note 1) (Fig. 6) @0V, 1MHz $C_{J(SD)}$ pF
PSRDA3.3-4	PRA	3.3	4.0	6.5	125	5
PSRDA05-4	PRB	5.0	6.0	9.8	20	5
PSRDA12-4	PRD	12.0	13.3	19.0	1	5
PSRDA15-4	PRE	15.0	16.7	24.0	1	5

## NOTES

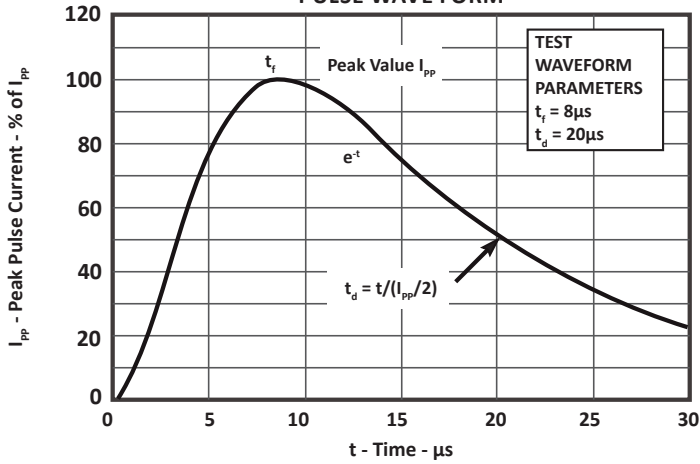
1. Capacitance measured at  $V_{WM} = V_{CC}$  connected between I/O pins to pin 8 and 5 (Gnd).  $V_R = V_{WM}$  @ 1MHz. As shown in Figure 6, REF1 is connected to ground, REF2 is connected to + $V_{CC}$  and input applies to  $V_{CC} = 5V$ ,  $V_{SIGN} = 30mV$ ,  $F = 1MHz$

FIGURE 1  
PEAK PULSE POWER VS PULSE TIME

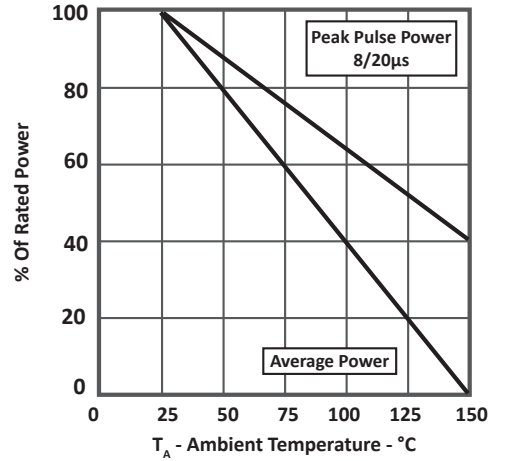


TYPICAL DEVICE CHARACTERISTICS

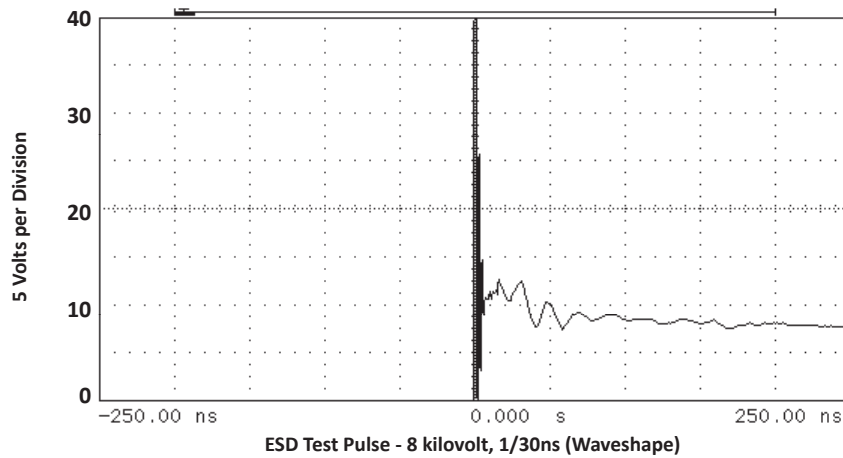
**FIGURE 2**  
PULSE WAVE FORM



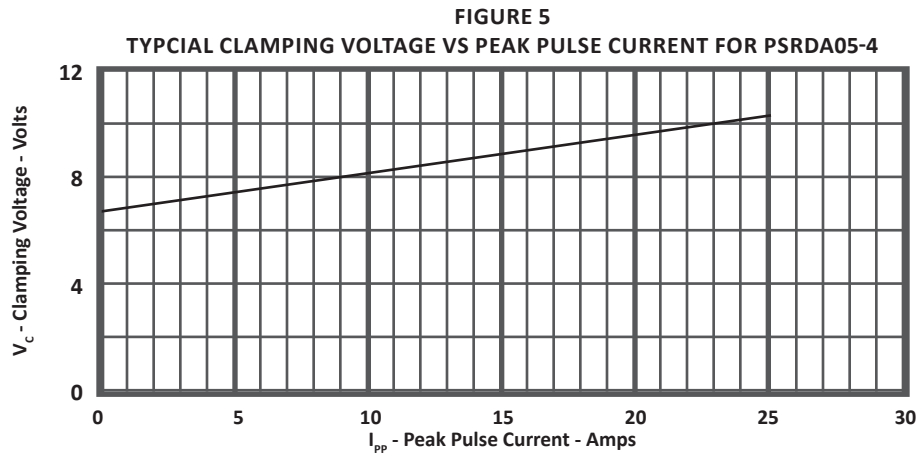
**FIGURE 3**  
POWER DERATING CURVE



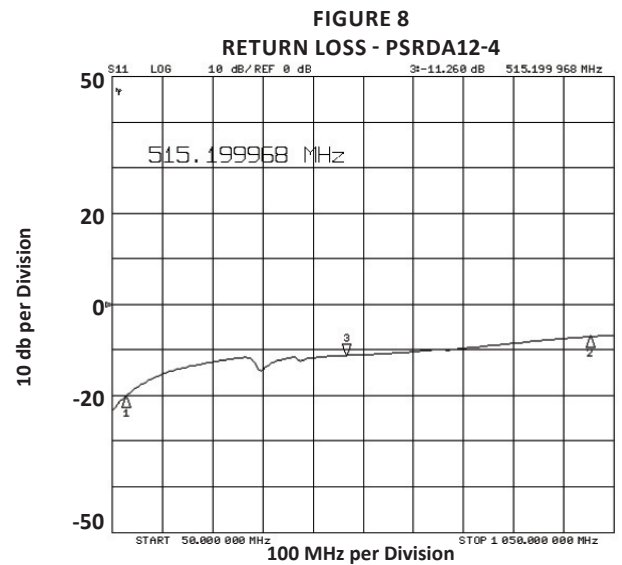
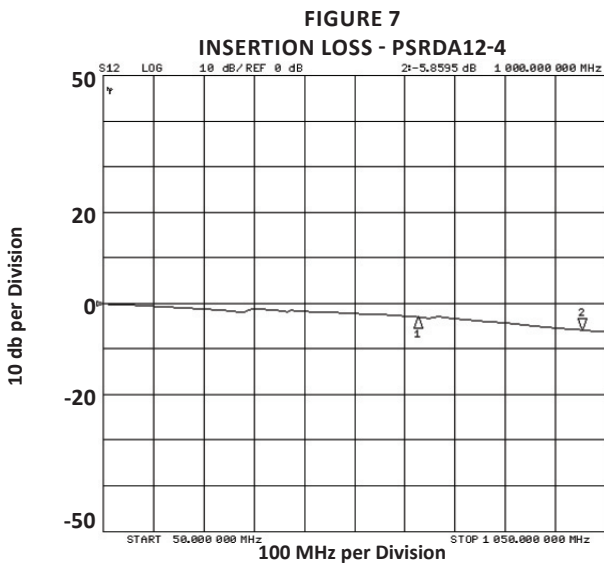
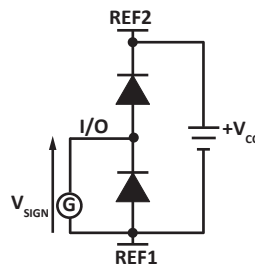
**FIGURE 4**  
OVERSHOOT & CLAMPING VOLTAGE FOR PSRDA05-4



TYPICAL DEVICE CHARACTERISTICS

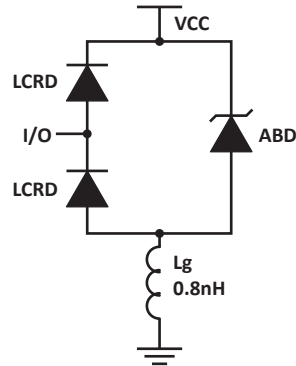


**FIGURE 6**  
INPUT CAPACITANCE CIRCUIT



## SPICE MODEL

FIGURE 1  
SPICE MODEL



ABD - Avalanche Breakdown Diode (TVS)  
 LCRD: Low Capacitance Rectifier Diode  
 Lg - Lead Inductance

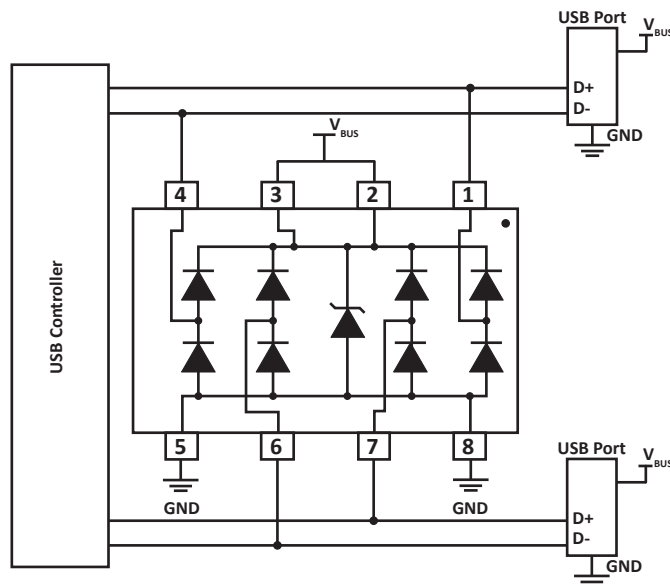
TABLE 1 - SPICE PARAMETERS

PARAMETER	UNIT	ABD(TVS)	LCRD
BV	V	See Table 2	200
IBV	$\mu\text{A}$	1	0.01
$C_{jo}$	pF	See Table 2	5
$I_s$	A	See Table 2	1E-13
Vj	V	0.6	0.6
M	-	0.33	0.33
N	-	1	1
$R_s$	Ohms	See Table 2	0.31
TT	s	1E-8	1E-9
EG	eV	1.11	1.11

TABLE 2 - ABD SPECIFIC SPICE PARAMETERS

PART NUMBER	$B_v$ (VOLTS)	$C_{jo}$ (pF)	$I_s$ (AMPS)	$R_s$ (OHMS)
PSRDA3.3-4	4.0	438	1E-11	0.21
PSRDA05-4	6.0	284	1E-11	0.14
PSRDA12-4	13.3	123	1E-11	0.4
PSRDA15-4	16.7	102	1E-11	0.52

## APPLICATION INFORMATION



### FIGURE 1 - DIFFERENTIAL MODE USB PROTECTION

Circuit connectivity is as follows:

- Pins 1, 2, 4, 6 and 7 connected to the datalines.
- Pin 5 and 8 connected to ground.
- Pins 2 and 3 connected to the databus.

### CIRCUIT BOARD RECOMMENDATIONS

Circuit board layout is critical for electromagnetic compatibility protection. The following guidelines are recommended:

- The protection device should be placed near the input terminals or connectors, the device will divert the transient current immediately before it can be coupled into the nearby traces.
- The path length between the TVS device and the protected line should be minimized.
- All conductive loops including power and ground loops should be minimized.
- The transient current return path to ground should be kept as short as possible to reduce parasitic inductance.
- Ground planes should be used whenever possible. For multilayer PCBs, use ground vias.

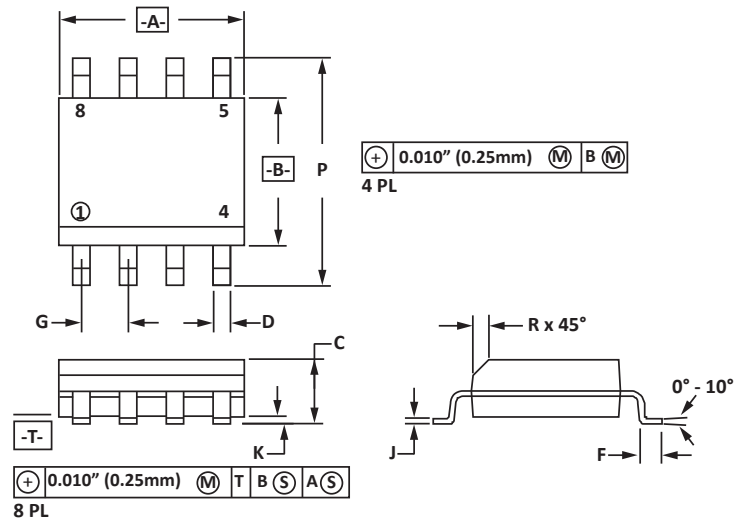
## SO-8 PACKAGE INFORMATION

## OUTLINE DIMENSIONS

DIM	MILLIMETERS		INCHES	
	MIN	MAX	MIN	MAX
A	4.80	5.00	0.189	0.196
B	3.80	4.00	0.150	0.157
C	1.35	1.75	0.054	0.068
D	0.35	0.49	0.014	0.019
F	0.40	1.25	0.016	0.049
G	1.27 BSC		0.05 BSC	
J	0.18	0.25	0.007	0.009
K	0.10	0.25	0.004	0.008
P	5.80	6.20	0.229	0.244
R	0.25	0.50	0.010	0.019

## NOTES

- T = Seating plane and datum surface.
- Dimensions "A" and "B" are datum.
- Dimensions "A" and "B" do not include mold protrusion.
- Maximum mold protrusion is 0.015" (0.380mm) per side.
- Dimensioning and tolerances per ANSI Y14.5M, 1982.
- Dimensions are exclusive of mold flash and metal burrs.

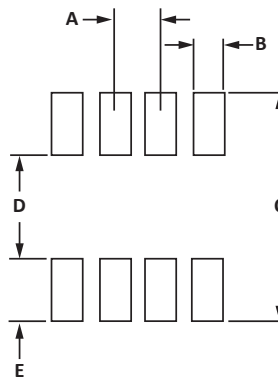


## PAD LAYOUT DIMENSIONS

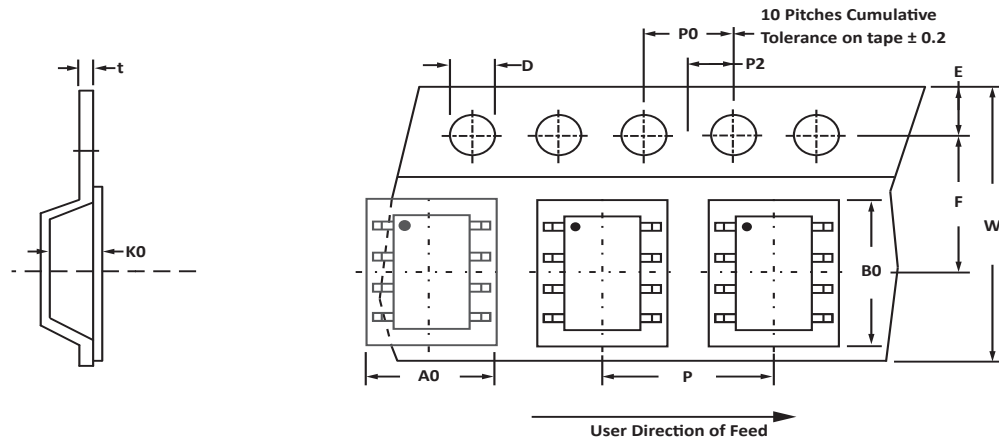
DIM	MILLIMETERS		INCHES	
	MIN	MAX	MIN	MAX
A	1.14	1.40	0.045	0.055
B	0.64	0.89	0.025	0.035
C	6.22	-	0.245	-
D	3.94	4.17	0.155	0.165
E	1.02	1.27	0.040	0.050

## NOTES

- Controlling dimension: inches.



## TAPE AND REEL



## SPECIFICATIONS

REEL DIA.	TAPE WIDTH	A0	B0	K0	D	E	F	W	P0	P2	P	tmax
178mm (7")	12mm	6.50 $\pm$ 0.10	5.40 $\pm$ 0.10	2.00 $\pm$ 0.10	1.50 $\pm$ 0.10	1.75 $\pm$ 0.10	5.50 $\pm$ 0.05	12.00 $\pm$ 0.30	4.00 $\pm$ 0.12	2.00 $\pm$ 0.10	8.00 $\pm$ 0.10	0.25

## NOTES

- Dimensions are in millimeters.
- Surface mount product is taped and reeled in accordance with EIA-481.
- Suffix - T7 = 7" Reel - 1,000 pieces per 12mm tape.
- Suffix - T13 = 13" Reel - 2,500 pieces per 12mm tape.
- Bulk product shipped in tubes of 98 pieces per tube.
- Marking on Part - marking code (see page 2), date code, logo and pin one defined by dot on top of package.

## ORDERING INFORMATION

BASE PART NUMBER (xx = Voltage)	LEADFREE SUFFIX	TAPE SUFFIX	QTY/REEL	REEL SIZE	TUBE QTY
PSRDAxx-4	-LF	-T7	1,000	7"	98
PSRDAxx-4	-LF	-T13	2,500	13"	98

This device is only available in a Lead-Free configuration.



## COMPANY INFORMATION

---

### COMPANY PROFILE

In business more than 25 years, ProTek Devices™ is a privately held semiconductor company. The company offers a product line of overvoltage protection and overcurrent protection components. These include transient voltage suppressor array (TVS arrays) avalanche breakdown diode, steering diode TVS array and electronics SMD chip fuses. These components deliver circuit protection in electronic systems from numerous overvoltage and overcurrent events. They include lightning; electrostatic discharge (ESD); nuclear electromagnetic pulses (NEMP); inductive switching; and electromagnetic interference (EMI) / radio frequency interference (RFI). ProTek Devices also offers LED wafer die for ESD protection and related high frequency products. ProTek Devices is ISO 9001:2015 certified.

### CONTACT US

#### Corporate Headquarters

2929 South Fair Lane  
Tempe, Arizona 85282  
USA

#### By Telephone

General: 602-431-8101  
Sales: & Marketing: 602-414-5109  
Customer Service: 602-414-5114  
Product Technical Support: 602-414-5107

#### By Fax

General: 602-431-2288

#### By E-mail:

Asia Sales: [asiasales@protekdevices.com](mailto:asiasales@protekdevices.com)  
Europe Sales: [europesales@protekdevices.com](mailto:europesales@protekdevices.com)  
U.S. Sales: [ussales@protekdevices.com](mailto:ussales@protekdevices.com)  
Distributor Sales: [distysales@protekdevices.com](mailto:distysales@protekdevices.com)  
Customer Service: [service@protekdevices.com](mailto:service@protekdevices.com)  
Technical Support: [support@protekdevices.com](mailto:support@protekdevices.com)

#### ProTek Devices (Asia Pacific) Pte. Ltd.

8 Ubi Road 2, #06-19  
Zervex  
Singapore - 408538  
Tel: +65-67488312  
Fax: +65-67488313

#### Web

[www.protekdevices.com](http://www.protekdevices.com)

COPYRIGHT © ProTek Devices 2007 - This literature is subject to all applicable copyright laws and is not for resale in any manner.

SPECIFICATIONS: ProTek reserves the right to change the electrical and or mechanical characteristics described herein without notice.

DESIGN CHANGES: ProTek reserves the right to discontinue product lines without notice and that the final judgement concerning selection and specifications is the buyer's and that in furnishing engineering and technical assistance. ProTek assumes no responsibility with respect to the selection or specifications of such products. ProTek makes no warranty, representation or guarantee regarding the suitability of its products for any particular purpose, nor does ProTek assume any liability arising out of the application or use of any product or circuit and specifically disclaims any and all liability without limitation special, consequential or incidental damages.

LIFE SUPPORT POLICY: ProTek Devices products are not authorized for use in life support systems without written consent from the factory.

## X-ON Electronics

Largest Supplier of Electrical and Electronic Components

*Click to view similar products for [protek manufacturer](#):*

Other Similar products are found below :

[MAD1108-LF](#) [SMDA05C-LF](#) [505](#) [2690051-1](#) [REV E](#) [PLR0524P-LF-T7](#) [15KPA78ALF](#) [SM14M08CLF](#) [15KPA45A-LF](#) [SMDA12LC-LF](#)  
[PSMDA05C-8-LF](#) [PSRDA05-4-LF-T7](#) [SM16LC24-LF](#) [GPZ1275](#) [SM16LC15CLF](#) [SMDB15C-LF](#) [SM8LC12LF](#) [PMMAD1109-LF](#)  
[PLCDA24-LF](#) [SMDA15LCC-LF](#) [PLC496-LF](#) [SM16LC05C-LF](#) [PLCDA12C6LF](#) [PLCDA12LF](#) [30KPA360CA-LF](#) [MAD1107-LF](#)  
[SMDB05CLF](#) [15KPA22A-LF](#) [30KPA48CALF](#) [SMDA05-LF](#) [30KPA36A-LF](#) [SM16LC12C-LF](#) [SLVU2.8-4-LF-T7](#) [SMDB12-LF](#)  
[SM16LC05C-LF-T7](#) [MMAD1107LF](#) [PD10563](#) [VS10P15C-LF](#) [SMP6LC6.5-2P-LF-T7](#) [PLCDA15C6LF](#) [SMDA12LCCLF](#) [15KPA48CA-LF](#)  
[60KS200C](#) [30KPA48A-LF](#) [SM1615C-LF](#) [PLC03-6-LF-T7](#) [15KPA18ALF](#) [PSLC15LFT7](#) [MMAD130-LF](#) [SM8LC05-LF](#) [SR3.3-LF-T7](#)