

PROXXON

PROXXON
MICROMOT
System

***Tools
with character!***



2019/2020

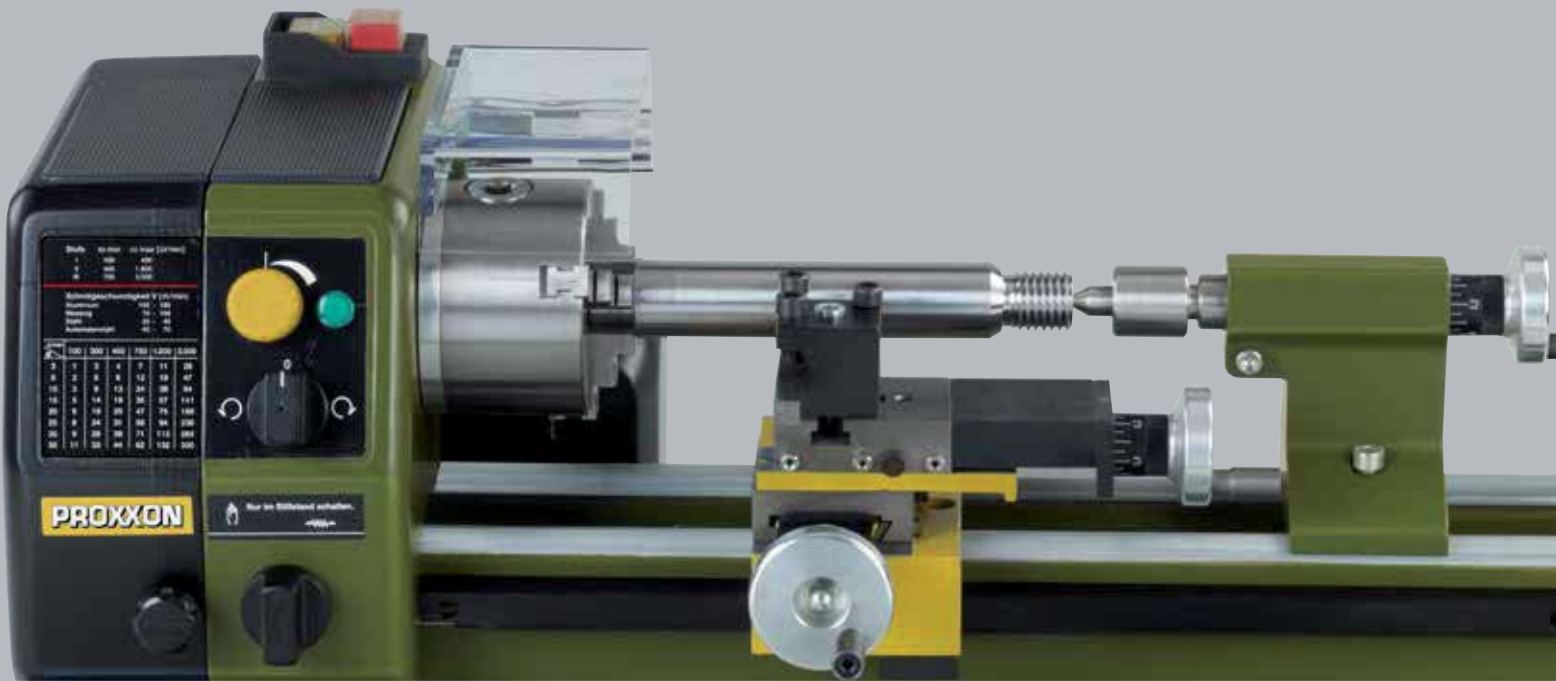



Multiversatile equipment for delicate projects. Precise and quiet.
With quick change chuck. Made in Europe.

Precision drill/grinder FBS 240/E Strength comes from quality!

For drilling, milling, grinding, polishing, cleaning, carving and engraving.

The maximum speed of 22,000rpm is continuously variable down to 5,000rpm. The full wave electronic speed control results in virtually constant torque, even at lower speeds, in turn facilitating micro drilling, cleaning and polishing. The spindle runs in a precision ball bearing and is lifted with a lock button. The 20mm collar fits MICROMOT drill stands and vices.

The machine is fitted with a special, balanced, low noise DC motor with high life expectancy. Stable housing of glass-fibre reinforced POLYAMIDE with soft components in the finger grip area.

Complete with 43 quality inserts in a sturdy plastic case.

Technical data:

230V. 5,000 – 22,000rpm. 100W. Length 200mm. Weight 450g.

Insulated to class 2.

With keyless chuck for shanks from 0.3 – 3.2mm.

NO 28 472

Note:

The FBS 240/E may also be fitted with the optional MICROMOT steel collets (see page 24).



Note:

You will find the super slim MICROMOT 230/E with a diameter of 37mm and a weight of only 270g on page 14.

Stable housing of glass-fibre reinforced POLYAMIDE with soft components in the finger grip area.



Complete with 43 high-quality bits and cutters in a durable polypropylene case.



Our website www.proxxon.com offers videos that show the most important features of the products marked with this symbol. Come have a look!



- High quality 10.8V lithium-ion battery with 2.6Ah for highest performance.
- Gear head of die-cast aluminium. Main housing of glass-fibre reinforced POLYAMIDE with soft component in grip area.
- All tools with continuously variable speed control and special balanced DC motor: powerful, quiet and durable.



Practical:
The flat end cap of the battery enables the tools to stand upright as well.



For several decades we have been producing high quality fine power tools for the MICROMOT system in Wecker/Luxemburg.



Rapid battery charger LG/A2

Charges the PROXXON lithium-ion battery Li/A2 in one hour. With integrated temperature control.

LED signal light: Yellow = charging, Green = charged.

Technical data:

Input 100 – 240V, 50/60Hz. Output 12.6V, 2A. Weight approx. 340g.

NO 29 880

Lithium-ion battery Li/A2

For long and durable powerful operation of our MICROMOT cordless tools. With integrated temperature control for safe operation.

Technical data:

Voltage 10.8V. Capacity 2.6Ah. Length 85mm. Weight 180g.

NO 29 896



Cordless tools made in Europe. Strong problem solvers for craft and industry. One battery charge allows for at least 30 minutes of use even at maximum speed.

Cordless long neck angle grinder LHW/A



For working on steel, non-ferrous metal, glass, ceramics, wood and plastic. For cutting, roughing and grinding.

Supplied with corundum grinding disc (grit 60), fan sander (grit 100) and reinforced cutting disc. Set includes lithium-ion battery Li/A2 (10.8V) and rapid battery charger LG/A2.

Technical data:

10.8V. 5,000 – 16,000rpm. Discs Ø 50mm with 10mm bore. Length 320mm. Weight approx. 800g (including battery).

NO 29 815

Cordless long neck angle grinder LHW/A

As described on the left, also including listed accessories. But without battery and rapid charger. Packed in a cardboard box.

NO 29 817

Cordless belt sander BS/A



For grinding of small openings, finishing of moulds, surfaces, radii, grooving, deburring and chamfering of precision parts.

The head rotates through 60° at the push of a button. Suction connection with vacuum cleaner adapter enables clean working. Supplied with 4 sanding belts (2 pieces each grit 80 and grit 180). Set includes lithium-ion battery Li/A2 (10.8V) and rapid battery charger LG/A2.

Technical data:

10.8V. Sanding belt 10 x 330mm (usable sanding area 10 x 110mm). Sanding speed 200 – 700m/min. Length 380mm. Weight approx. 900g (including battery).

NO 29 810

Cordless belt sander BS/A

As described on the left, with 4 sanding belts. But without battery and rapid charger. Packed in a cardboard box.

NO 29 812

Cordless angle polisher WP/A



The mobile version of our already proven corded tool for more flexibility when polishing, cleaning, in rust removal and adding the “finishing touches” after varnishing.

With plenty of accessories such as: rubber backing disc with hook and loop fastening, polishing sponge (medium hard), lambswool polishing disc, polishing felt (medium hard) for metal and non-ferrous metal, 12 sanding discs (grit 2000) and NIGRIN polishing emulsion (75ml) as well as a microfibre cloth. Set includes lithium-ion battery Li/A2 (10.8V) and rapid battery charger LG/A2.

Technical data:

10.8V DC. Spindle speeds 1,100 – 2,800rpm. Length 305mm. Weight 950g (including battery).

NO 29 820

Cordless angle polisher WP/A

Including accessories as described on the left, but without battery and rapid charger. Packed in a cardboard box.

NO 29 822

Note:

You will find a wide range of suitable accessories for all cordless tools on the pages of the corded sister tools (6-13).

Our special brochure for cordless tools (available in German NO 95 138, and English NO 95 295) features all cordless models and matching accessories. Please ask for your copy!

Industry:
 Maximum power. No other cordless tool lasts longer in this class!

Cordless professional drill/grinder IBS/A



For drilling, milling, grinding, polishing, cleaning, cutting, engraving and signing.

Double-row ball bearing, precision spindle of ground steel and six triple slit MICROMOT steel collets (1 – 1.5 – 2 – 2.4 – 3 and 3.2mm) ensure high concentric accuracy. Bits and cutters run true. With 20mm MICROMOT collar for use in drill and horizontal stands. With 34 bits and cutters (see fig. IBS/E, page 6). Set includes lithium-ion battery Li/A2 (10.8V) and rapid battery charger LG/A2.

Technical data:

10.8V. 7,000 – 23,000rpm. Length 270mm. Weight approx. 700g (including battery).

NO 29 800

Cordless professional drill/grinder IBS/A

As described on the left, with 6 MICROMOT steel collets. But without battery, rapid charger and bits and cutters. Packed in a cardboard box.

NO 29 802

Cordless cylinder sander WAS/A



For perfect surface fine-finishing even where space is tight. For grinding, brushing, satin-finishing as well as cleaning of steel, non-ferrous metal and especially stainless steel.

Compact grinding mop cylinder (Ø 50 x 30mm). With satin-finishing cylinder "medium" and one each grinding mop cylinder 120 grit and 240 grit. Set includes lithium-ion battery Li/A2 (10.8V) and rapid battery charger LG/A2.

Technical data:

10.8V DC. Satin-finishing and grinding mop cylinder Ø 50mm, width 30mm. Spindle speeds 1,100 – 2,800/rpm. Length 305mm. Weight approx. 1,000g (including battery).

NO 29 825

Cordless cylinder sander WAS/A

As described on the left with accessories. But without battery and rapid charger. Packed in a cardboard box.

NO 29 827

Cordless tube belt sander RBS/A



For perfect surfaces without refinishing by hand. Also ideal for structural VA-steelwork and pipe fitting.

The head can be angled by up to 60° at the push of a button. Suction connection with vacuum cleaner adapter permits clean working. Supplied with 4 abrasive belts (2x grit 80, 2x grit 180) and 2 satin-finishing belts. Set includes lithium-ion battery Li/A2 (10.8V) and rapid battery charger LG/A2.

Technical data: 10.8V DC. Abrasive belt 10 x 330mm. Usable grinding area approx. 10 x 50mm and 10 x 70mm. Belt speed 200 – 700m/min. Weight approx. 900g (including battery).

NO 29 830

Cordless tube belt sander RBS/A

As described on the left with accessories. But without battery and rapid charger. Packed in a cardboard box.

NO 29 832

Replacement satin-finishing belt for RBS/A



On tear-resistant, woven backing. For grinding and satin-finishing of metal, non-ferrous metal and especially stainless steel. 10 x 330mm.

NO 28 576 fine 4 pieces

Professional drill/grinder IBS/E

- For drilling, milling, grinding, polishing, cleaning, cutting, carving, engraving and signing.
- For precision mechanics, model builders, jewellers, opticians, artists and electronic enthusiasts.

Note:

For any job on the workbench we recommend the use of our mains-connected tools. They are light-weight, easy to handle (shorter) and not limited as to the time of operation.

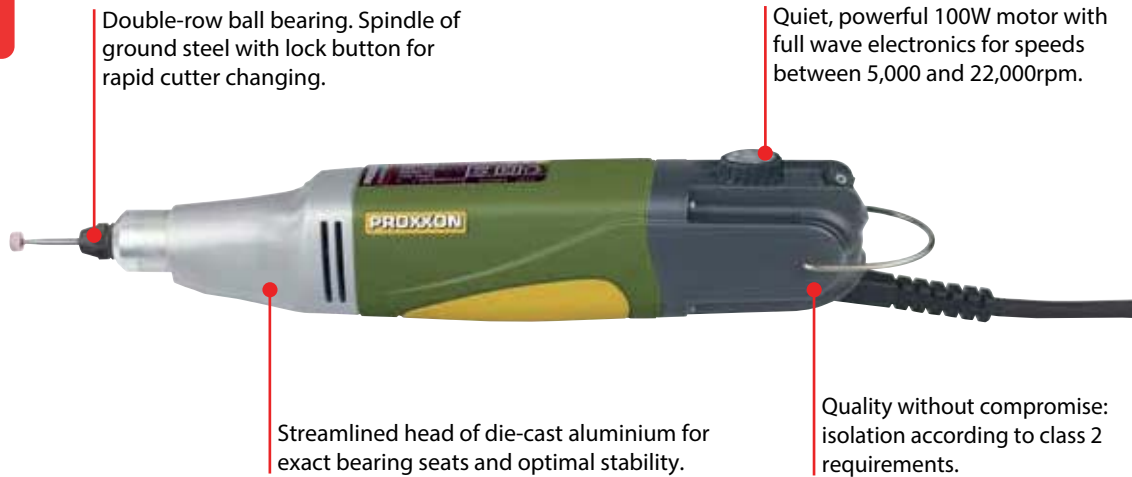

With 34 bits and cutters of industrial quality, all shafts Ø 2.35mm. Complete with six triple slit steel collets covering 1 to 3.2mm (see page 24).

High concentric accuracy (maximum runout 3/100mm). No runout in your bits and cutters.

This high-revving, special balanced, low noise DC motor has full-wave electronic speed control. The ground steel spindle runs in a ball bearing. Six high concentricity MICROMOT collets, (1 – 1.5 – 2 – 2.4 – 3 and 3.2mm and closure nut) are included. Stable gear head of die-cast aluminium with 20mm MICROMOT collar allows fitting of optional drill

stands and horizontal stands. Main housing of glass-fibre reinforced POLYAMIDE. Supplied with 34 bits and cutters in a stable plastic case.

Technical data :

230V. 5,000 – 22,000rpm. 100W. Length 230mm. Weight 500g. Insulated to class 2.

NO 28 481

Note:

MICROMOT steel collets are hardened and thus have a high, consistent flexibility. ① They also maintain prolonged accuracy, even after regular use (these collets should not be compared with unhardened, four-slit collets of brass and aluminium). The triple slit collet is substantially more difficult to manufacture than the four-slit type, ② but offers a better load-bearing surface. This is especially important for ③ cutters with small shaft diameters. Also see page 24.

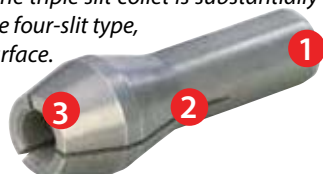

All depicted tools are supplied in a storage case of high-grade polypropylene. Attractive design, very sturdy and large enough to put the machine back in the case after completing work, without having to "fumble". A label on the side identifies the contents.



The heart of our MICROMOT precision tools for 230V!

A comparatively more expensive direct current (DC) special motor with permanent magnet technology.

In relation to its size, the permanent magnet technology makes it very powerful, quiet and long-lasting. Due to its very high efficiency, this motor requires considerably less power for the same power output from the socket outlet than other motors commonly used in power tools.

Of course, when using these motors our basic concept is to produce small, slender tools with high performance. The outstanding ratio of current consumption: power output also contributes significantly to energy saving, thereby also protecting our environment!



Long neck angle milling/drilling unit LWB/E



With a set of gears running on several ball bearings in a stable, die-cast aluminium housing head.

Also suitable for right-angled separation of rods. With a special balanced, powerful, quiet and long-lasting DC motor. Infinitely variable rpm (full wave electronics). Main housing is made of glass-fibre reinforced POLYAMIDE.

Safely stored in an attractive and extremely stable case made from high-grade POLYPROPYLENE, as described on the left.

With MICROMOT hardened steel collets (1 – 1.5 – 2 – 2.4 – 3 and 3.2mm).

Technical data:

230V. 100W. 3,000 – 15,000rpm. Length 270mm. Weight 550g. Insulated to class 2.

NO 28 492



Long neck straight drill/grinder LBS/E



Bit holder for storing rotating bits and cutters is included in the delivery.



Head of die-cast aluminium with 75mm long spindle neck (and 20mm MICROMOT collar).

Thus ideal for internal grinding and the use in slots and channels. Double-row ball bearing. Spindle of ground steel with lock button for rapid cutter changing. Special balanced, powerful, quiet and long-lasting DC motor. Variable (full wave) electronic speed control. Main housing of glass-fibre reinforced POLYAMIDE. MICROMOT collets (1 – 1.5 – 2 – 2.4 – 3 and 3.2mm).



Safely stored in an attractive and extremely stable case made from high-grade polypropylene, as described on the left.

Technical data:

230V. 100W. 5,000 – 22,000/min. Length 300mm. Weight 630g. Insulated to class 2.

NO 28 485



Long neck angle grinder LHW

230 VOLT



For working steel, non-ferrous metals, glass, ceramics, wood and plastic. For cutting, rough-machining, grinding and carving wood. Special balanced, powerful, quiet and long-lasting DC motor. Main housing made of glass-fibre reinforced POLYAMIDE. A corundum grinding disc (grit 60), a fan sanding disc (grit 100) and a reinforced cutting disc are included. Safely stored in an attractive and extremely stable case made from POLYPROPYLENE.

Technical data:

230V. 100W. 15,000rpm. Disc diameter 50mm with 10mm interval. Length 270mm. Weight 550g. Run down time less than 1 second. Insulated to class 2.

NO 28 547

Accessories for LHW and LHW/A



Backing disc

Self-adhesive type, for use with corundum bound sanding discs and sanding fleece. Ø 50mm.

NO 28 548 1 piece



Corundum sanding disc

Self-adhesive type, used on flat and convex surfaces. Ø 50mm.

NO 28 549 80 grit 12 pieces
NO 28 550 150 grit 12 pieces



Sanding fleece

Self-adhesive type, used for cleaning, matting and sanding of steel, stainless steel and non-ferrous metals. Also used for paint removal. Ø 50mm.

NO 28 554 medium 5 pieces
NO 28 555 fine 5 pieces



Corundum grinding disc

Used for de-burring, grinding, sharpening and de-rusting steel and non-ferrous metals. Ø 50mm.

NO 28 585 60 grit



Silicon carbide grinding disc

Used on hard materials such as glass, stone, ceramics and even hardened steel. Ø 50mm.

NO 28 587 60 grit



Corundum fan sander

For grinding tempered cast iron, cast iron, stainless steel, non-ferrous metals, wood and plastic. Low wear-resistant. Ø 50mm.

NO 28 590 100 grit



Corundum bound cutting disc

With woven reinforcement. 50 x 1 x 10mm. For cutting steel, non-ferrous metals, plastic and wood. Ø 50mm.

NO 28 155 5 pieces

Rasp plate with metal burrs made from wolfram carbide



For model-making, cleaning and smoothing of wood, plastics and glass-fibre reinforced objects. No expenditure of effort is needed, easy and precise handling. Ø 50mm.

Not suitable for metal processing.

NO 29 050



All depicted tools are supplied in a storage case of high-grade polypropylene. Attractive design, very sturdy and large enough to put the machine back in the case after completing work, without having to "fumble". A label on the side identifies the contents.



*Compact design, high torque robust and extremely versatile.
With gear head of die-cast aluminium. Made in Europe.*



Belt sander BS/E



For shape finishing, mortising, fine polishing (flat surfaces). Also for de-burring metal, paint removal and fine finishing.

Head of die-cast aluminium for high stability and precise ball bearing fitting. Main housing made of glass-fibre reinforced POLYAMIDE.

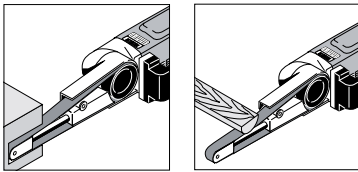

Variable (full wave) electronic speed control. The head rotates through 60°. Complete with 2 off 80 and 2 off 180 grit belts.

Safely stored in an attractive and extremely stable case made from high-grade polypropylene, as described on the left.

Technical data

230V. 80W. Belt size 10 x 330mm (usable sanding area 10 x 110mm). Belt speed 225 – 450rpm. Length 350mm. Weight 650g. Insulated to class 2.

NO 28 536

Replacement belts for BS/E and BS/A



Corundum on tear-resistant, woven backing. Sands metal, non-ferrous metals, wood and plastics efficiently. 10 x 330mm.

NO 28 583	80 grit	5 pieces
NO 28 582	120 grit	5 pieces
NO 28 581	180 grit	5 pieces

The head of both BS/E and BS/A (page 3) rotates through 60°.



Identical with the foregoing item, but with burrs made from silicon carbide for grinding and de-burring of glass and ceramics. Also suitable for grinding brass, steel and cast iron.

NO 28 579	180 grit	5 pieces
------------------	----------	----------

Super jig saw STS/E



This unit offers fantastic and precise cutting capacity. Stable head of die-cast zinc for precise fitting.

The housing head is made of glass-fibre reinforced POLYAMIDE. Special balanced, low noise DC motor with high life expectancy. The stroke speed is variable by means of full wave electronic speed control. Footplate adjustable up to 45° for mitre cuts. Ideal for tight curves in wood (up to 12mm), PC cards to 5mm and non-ferrous metals to 3mm. Complete with 4 Super-Cut sawing blades of various pitches for wood, plastic and metal. Safely stored in an attractive and extremely stable case made from high-grade polypropylene, as described on the left.

Technical data:

230V. 80W. Stroke speed of 2,000 – 4,500/min. Length 230mm. Weight 700g. Insulated to class 2.

NO 28 530

Note:

The alternative 12V jig saw STS 12/E is described on page 18.

Jig saw blades made of special steel

Pitch of 1.5mm, teeth ground and set. Usable on hard and soft woods, plywood, fibreglass reinforced sheets as well as soft plastics. Fits STS/E and STS 12/E.

NO 28 054 Pack of 2



Jig saw blades made of HSS

Tooth pitch of 1.06mm, with teeth set and ground. Usable on metals, non-ferrous metals, aluminium and softer alloys, fibreglass, Plexiglass and insulating materials. Fits STS/E and STS 12/E.

NO 28 056 Pack of 2



Due to its unique oscillating motion also ideal for cutting, where round and rotating saw blades cannot be used. Made in Europe.

Delta sander OZI/E

230 VOLT

DM/028928
Design Patent
All rights by PROXXON



The oscillating motion ensures lack of vibration and kickback and allows the fitting of cutting blades too!!

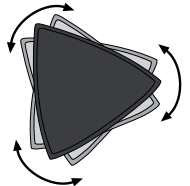

Small yet efficient: For grinding surfaces in very tight spots. With hook and loop fastening for quick abrasive change.

The oscillating motion ensures quiet operation and allows with the available accessories also for cutting and plunge cutting. Insert and cut! The variable speed facility ensures the correct speed for every material. Special, balanced, low noise DC motor with high life expectancy. Gear head made of die-cast zinc for precise and stable bearing of moving parts. Main housing of glass-fibre reinforced POLYAMIDE.

Supplied with 10 each sanding pads of 80, 150 and 240 grit as well as an HSS plunge saw blade (width 14mm) for square precision cuts in wood, plastics and aluminium. In an attractive case, as described on the right.



Technical data:

230V. 80W. Sanding frequency of 5,000 – 12,000rpm. Length 230mm. Weight 550g. Insulated to class 2.

NO 28 520

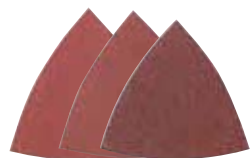

Sanding pads for OZI/E

High durability corundum (aluminium oxide) pads. Grain filled with special filler to prevent premature clogging. Deposited on special backing paper. Self-adhesive.

NO 28 891 80 grit 25 pieces
NO 28 893 150 grit 25 pieces
NO 28 895 240 grit 25 pieces



HSS cutting blade for OZI/E

Cuts metal, wood, GRP (glassfibre reinforced plastic), plastics, plaster of Paris and many other materials. The segment cut enables accurate work right into corners without over cutting.

NO 28 900 Ø 65mm, 160 teeth



Diamond cutting blade for OZI/E

Use as described above for the HSS cutting blades. Cuts marble, bricks, dry wall and many other materials.

NO 28 902 Ø 65mm



HSS immersion saw blades for OZI/E

For exact square excavations. For making hatchways and windows in ship and aircraft models. Cuts wood, plywood, plastics and aluminium. Max. immersion depth 16mm.

NO 28 897 Saw blade width 8mm
NO 28 898 Saw blade width 14mm

For precision square excavations, HSS immersion saw blades are available with an 8 and 14mm width of cut.



The OZI/E cuts in those cases where a rotating saw blade can no longer be used (in this case using the HSS cutting blade).



Belt Sander BBS/S.

230 VOLT

NO 000472442
Design Patent
All rights by PROXXON





For perfect surface fine-finishing. With compact grinding mop cylinder 50 x 30mm and die-cast aluminium gear head. Made in Europe.

Cylinder sander WAS/E



For grinding and finishing steel, non-ferrous metals and stainless steel surfaces.

For grinding, brushing, satin finishing, but also cleaning. With compact grinding mop cylinder (Ø 50 x 30mm). Balanced special DC motor with infinitely variable speed control for material-specific working and constant speed even at high grinding pressure. Gear head made of die-cast aluminium, main housing of glass-fibre reinforced POLYAMIDE. With satin finishing roller „medium“ and each one grinding mop cylinder 120 grit and 240 grit. In high-quality case, as described below.

Technical data:

230V. 100W. Spindle speeds 800 – 2,800/min. Length 270mm. Weight 900g. Insulated to class 2.

NO 28 560

All depicted tools are supplied in a storage case of high-grade polypropylene. Attractive design, very sturdy and large enough to put the machine back in the case after completing work, without having to “fumble”. A label on the side identifies the contents.



Satin-finishing roller (fleece) for WAS/E and WAS/A

For cleaning, matting and satin-finishing of metal, non-ferrous metal and especially stainless steel.
Ø 50mm, width 30mm.



NO 28 565 medium 2 pieces

Grinding mop cylinder for WAS/E and WAS/A



For cleaning, grinding and stock removal on flat surfaces. Flapwheels of standard corundum are elastic and adapt to the contours of the workpiece.
Ø 50mm, width 30mm.

NO 28 561 grit 80 2 pieces
NO 28 562 grit 120 2 pieces
NO 28 563 grit 240 2 pieces

A compact, lightweight machine with an amazingly high stock removal rate!

Powered by a strong special DC motor, quiet and durable.

Left-aligned sanding belt allows for sanding right into corners. Fine adjustment of rollers prevents the belt from lateral roll-off. Easy replacement of bands without need for tools as rollers are under spring tension. Housing is made of glass-fibre reinforced POLYAMIDE. Supplied with each five 150 grit and 240 grit sanding belts. In addition, a screw clamp for stationary use. Packed in an attractive case as described above.

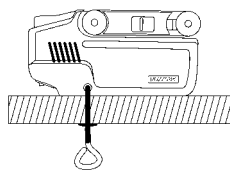

Technical data:

230V. 150W. Grinding band 40 x 260mm. Grinding surface 60 x 40mm, band speed 160m/min. Length 175mm. Weight 1,200g. Class 2 insulation.

NO 28 526

Grinding bands made from high-quality corundum (aluminium oxide)

Mounted on a high-performance support. For the grinding of metal, non-ferrous metals, wood and plastics.
40 x 260mm.

NO 28 922 80 grit 5 pieces
NO 28 924 150 grit 5 pieces
NO 28 928 240 grit 5 pieces





For carpenters, model makers and artistic wood carvers.
With die-cast aluminium gear head. Made in Europe.

Motor-driven carving device MSG



Three Japanese knife inserts of bimetal (hand-ground) are included.

For the carving of all types of wood. For the restoration of furniture. For the restoration of antiques. For linocuts and precision paint removal.

It is also possible to process plaster. Special, balanced, low noise DC motor with extreme high life expectancy. Gear head made of die-cast aluminium. Main housing of glass-fibre reinforced POLYAMIDE. Three high-grade Japanese knife inserts made from bimetal (U-form, V-form and flat blade) are included. In an attractive and extremely stable case made of high-grade polypropylene.

Technical data:

230V. 50W. Stroke speed 11,000rpm. Length 230mm. Weight 680g. Class 2 insulation.

NO 28 644

Replacement carving blades for MSG

Super-quality bimetal (Made in Japan). Base steel (carrier material) is bonded with extremely hard tungsten steel. The tips are hand-ground piece by piece. One blade each in V-shape, rounded large and small as well as flat straight and rounded.



NO 28 572

Multiform grindstone

For the Proxxon carving blades. Profiled for blade shapes. A pure oilstone for really sharp carving tools.

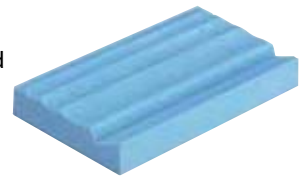

NO 28 578 100 x 63 x 15mm

Note:

The wolfram carbide rasp plate is ideal for wood carvers and used in connection with our long-neck angle grinders LHW and LHW/A. See page 8.



All depicted tools are supplied in a storage case of high-grade polypropylene. Attractive design, very sturdy and large enough to put the machine back in the case after completing work, without having to "fumble". A label on the side identifies the contents.





Infinitely variable electronic speed control for low and constant speeds even at high grinding pressure. Made in Europe.

Angle Polisher WP/E

230 VOLT



Packed in storage case, including extensive original equipment for immediate use.

For perfect surfaces even in tight spots: For finishing of blank surfaces, cleaning, rust removal, for the „finishing touches“ after varnishing.

Balanced special motor, powerful, quiet and long-lasting. Quiet planetary gear in die-cast aluminium housing and continuously variable speed control (full-wave electronics) for low and constant speeds even during high contact pressure. Main housing of glass-fibre reinforced POLYAMIDE with soft component. Securely stored in stylish case made of high-grade polypropylene with original equipment for immediate use. Rubber backing disc with hook and loop fastening, polishing sponge (medium hard), lambswool polishing disc, polishing felt for metals and non-ferrous metals (medium hard), 12 sanding discs K 2000 and NIGRIN polishing emulsion (75ml) as well as a microfibre cloth.

Technical data:

230V. 100W. 800 – 2,800rpm Length 270mm. Weight 720g. Insulated to class 2.
NO 28 660

Accessories for angle polishers WP/E and WP/A. Suitable for their original backing pad (Ø 50mm). All for hook and loop quick fastening.

Rubber backing disc



For use with polishing sponge, lambswool polishing disc, felt disc, sanding discs and sanding fleece. With hook and loop fastening. Ø 50mm.

NO 28 548 1 piece

Polishing felt, medium hard



For polishing metals (e.g. stainless steel, brass and copper). With hook and loop fastening. Ø 50mm.

NO 28 666 2 pieces

Lambswool polishing disc



Of high quality, dense lambswool for polishing scratch-proof paints. With hook and loop fastening. Ø 50mm.

NO 28 664 2 pieces

Professional polishing sponges



For applying the polishing emulsion to painted and metal surfaces with subsequent polishing. With hook and loop fastening. Ø 50 x 25mm.

NO 29 092 2 pieces soft (black)

NO 29 094 2 pieces medium (yellow)

NO 29 096 2 pieces hard (white)

Super-fine sanding discs



From silicon carbide. For adding finishing touches to paint or removing varnish runs and inclusions. Ø 50mm.

NO 28 667 12 pieces grit 400

NO 28 668 12 pieces grit 1,000

NO 28 670 12 pieces grit 2,000

Professional set for finish grinding and polishing. Includes 80mm extension and 30mm backing pad (for hook and loop quick-fastening).

For repairs and work in tight places, e.g. on motorcycles, rims, car interior and engine compartment. 80mm extension to reach also deep-lying problem areas. In addition to the extension and 30mm foam support plate, the scope of supply includes wave edged sanding discs each 12 pcs. 1,000 and 2,500 grit as well as conical polishing sponges each one hard, medium and soft.

NO 29 070

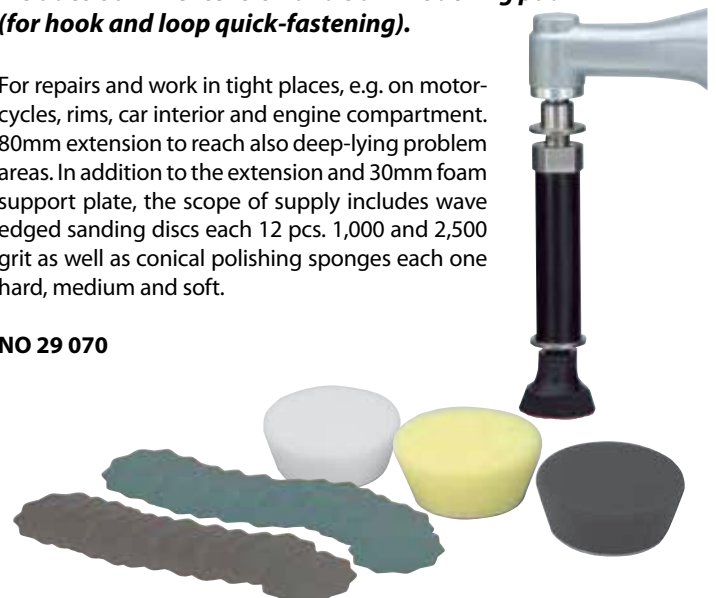



With a diameter of 37mm and just 270g it offers convenient handling second to none in its class!

MICROMOT 230/E



For drilling, milling, grinding, polishing, brushing, cutting, and engraving. The extremely slim housing (of glass-fibre reinforced POLYAMIDE) with a soft component grip area enables the unit to be handled with two fingers (pen grip).

Balanced DC special motor. Quiet and extremely long-lasting. The maximum speed of 22,000rpm can be continuously reduced to 6,000rpm through full-wave electronics. Offering nearly the same torque in the lower speed range. This is especially important during micro drilling, brushing and polishing.

Ground, ball-bearing spindle. High quality MICROMOT steel collets:

Even the smallest shafts are accurately clamped. No rattling or vibrating of bits and cutters. Spindle for tool exchange can be locked at the push of a button. 20mm standard collar for use with MICROMOT drill stands and horizontal stands. Includes steel collets (1 each of 1 – 1.5 – 2 – 2.4 – 3 and 3.2mm).



Technical data:

230V. 80W. 6,000 – 22,000rpm. Weight 270g. Insulated to class 2.

NO 28 440

Router base OFV

For MICROMOT units with standard 20mm collar. For slotting, milling grooves and milling edges.

Regardless whether with parallel limit stop (maximum throat 150mm), for circular milling with centring pin (100 – 400mm) or freehand. Of die-cast aluminium with plane-milled bearing surface. Adjustable depth control with preselectable stroke. Also ideal as drilling guide for round parts through prism in the guiding plate.

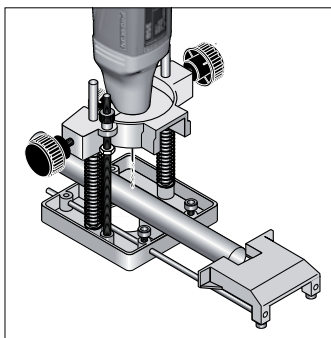

NO 28 566

The depicted professional drill/grinder IBS/E is not included in the scope of delivery.



Note:

You will find individual HSS wood router cutters on page 35.



Slim and light: A powerful DC special motor ensures a high cutting performance! Made in Europe.

MICRO-Cutter MIC



For cutting wood, plastics, glass fibre reinforced plastic, paper, cardboard, foils and similar materials. With 0.5mm cutting width.

Housing of glass-fibre reinforced POLYAMIDE. Gearing of tempered steel. The MIC makes it possible to "immerse" in the work piece surface (e.g. for cut-outs). The cutting disc guard moves up automatically during cutting. With screwdriver for saw blade replacement.

Technical Data:

230V. 40W. 20,000rpm. Maximum cutting depth 4mm. Cutting width 0.5mm. Weight approx. 300g. Insulated to class 2.

NO 28 650

Replacement cutting disc for MICRO Cutter MIC



Made of spring steel (hardness 55 HRC). With cleanly ground crossed teeth. 23 x 0.3mm. With 2.6mm bore.

NO 28 652

Diamond-coated cutting disc for MICRO Cutter MIC



With cooling holes: For cutting porcelain, ceramics, plastics, glass fibre reinforced plastic and PC cards. 23 x 0.6mm. With 2.6mm bore.

NO 28 654



Compact workshop vacuum cleaner CW-matic

The clever solution for a clean working environment: with direct connection for electric tools from 25 – 2,000W. The vacuum cleaner runs as long as the machine runs. Follow-up time of 5 seconds after switching off the power tool.

Smooth operation with high suction capacity. With large fluted filter made of POLYPROPYLENE to be cleaned and washed manually. Additional fine dust paper filter (not essential for this function). Container is easily emptied by removing the appliance lid with the motor unit. Blowing function available by refitting the vacuum hose. Also suitable for vacuuming liquids. Complete with 3.5m vacuum hose, 2-part aluminium vacuum pipe (98cm), floor nozzle, brush nozzle, crevice nozzle and adapter for connection to standard adapter of all such equipped PROXXON machines. Practical holder for the suction connection included (description on the left). Supplied with 6 fine dust paper filters.

Technical Data:

230V. 1,100W. Connection for electric tools from 25 to 2,000W. Container 18l. With 5m connection cable.

NO 27 490



Practical holder for the nozzle included in the scope of delivery:

For retaining the vacuum cleaner hose by inserting the holder's 20mm adapter into the universal holder UHZ (see p. 22) or clamping its strap into any vice.

Fine dust paper filter for CW-matic

For additional filter function. Must be removed when vacuuming liquids.

NO 27 494 5 pieces



Fluted filter for CW-matic

Made of POLYPROPYLENE. Can be cleaned dry or wet.

NO 27 492 1 piece





The new MICROMOT 60. The 4th generation of a tool tried and tested 1 million times over. Made in Europe. With high-quality steel collets.



- For drilling, milling, grinding, polishing, brushing, cutting and engraving. For working steel, precious metals, glass, ceramics, plastics and precious stones.
- With low safety voltage. Therefore, also suitable for working with coolant (wet grinding and cutting).

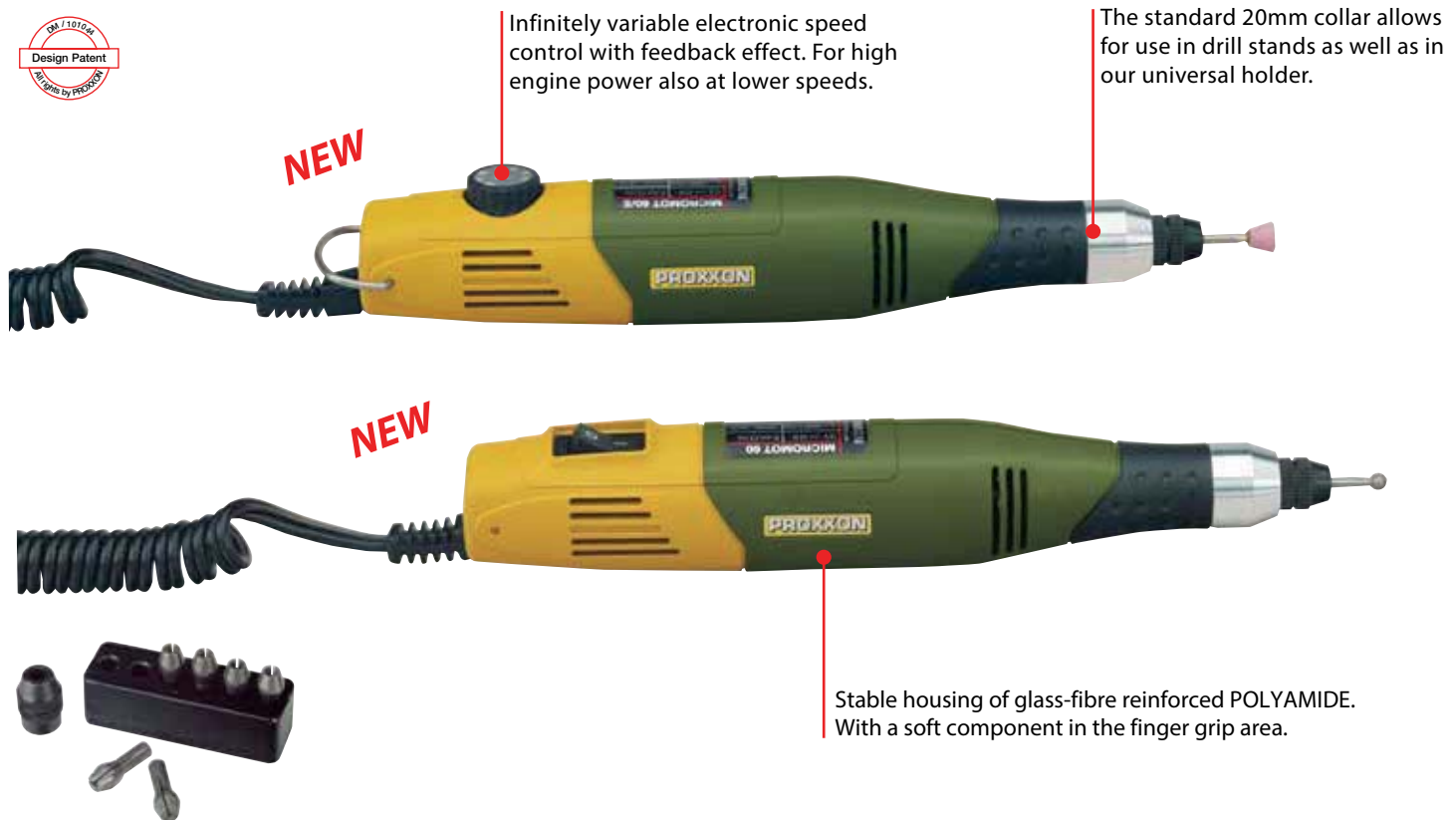

Infinitely variable electronic speed control with feedback effect. For high engine power also at lower speeds.

The standard 20mm collar allows for use in drill stands as well as in our universal holder.

Stable housing of glass-fibre reinforced POLYAMIDE. With a soft component in the finger grip area.

With a diameter of only 35mm and its low weight (230g) it offers convenient handling second to none in its class. The balanced motor effortlessly drives the ground ball bearing spindle allowing for a quiet run with a pleasant sound. High-quality MICROMOT steel collets ensure accurate clamping of even the smallest shafts, without rattling or vibrating of bits and cutters.

Mill/drill unit MICROMOT 60/E

Infinitely variable electronic speed control and high engine power also at lower speeds. Six MICROMOT steel collets (one each of 1 – 1.5 – 2 – 2.4 – 3 and 3.2mm) are included.

Technical data: Direct voltage 12 – 18V. 40W. 5,000 – 20,000rpm. Length 220mm. Weight 230g.

NO 28 510

Protective device for hand-operated MICROMOT machines with standard 20mm collar

For work with saw blades, cutting discs, milling bits, grinding tools, steel brushes and polishing tools. Maximum useable tool diameter 22mm. Easy to assemble.

NO 28 944



Mill/drill unit MICROMOT 60

Without electronic speed control (continuously 20,000rpm).

Other technical specifications and design as the above mentioned MICROMOT 60/E.

NO 28 500

Note:

MICROMOT steel collets are hardened and thus have a high, consistent flexibility. ① They also maintain prolonged accuracy, even after regular use (these collets should not be compared with unhardened, four-slit collets of brass and aluminium). The triple slit collet is substantially more difficult to manufacture than the four-slit type, ② but offers a better load-bearing surface. This is especially important for ③ cutters with small shaft diameters. Also see page 24.





*The new 60/EF with quick-action chuck.
Practical when working with different shaft diameters.*

Note:

A mains adapter is required to operate the MICROMOT 60 devices. We recommend the PROXXON mains adapter NG 2 (see page 21).

MICROMOT extension cord. 300cm.



For all 12V machines. Plug and wall-socket reverse polarity-protected.

NO 28 992

Footswitch FS

For free-hand precision work.



For all machines with a Euro plug (class 2 insulation) and maximum power absorption of 500W. Ideal for both portable and stationary machines. Housing of glass-fibre reinforced NYLON. The connecting cord (230V) is 250cm in length and the output cord 50cm. The transformer is connected to the FS when using 12V machines.

NO 28 700

MICROMOT 60/EF



Quick-action chuck of 0.3 – 3.2mm. Primarily advantageous when working with accessories of different shaft sizes, e.g. HSS drill bits.

20mm-system adaptation. For flange mounting of MICROMOT accessories.

Stable housing made of glass-fibre reinforced POLYAMIDE. With a pleasantly soft handle.



Slim, easily handled and light.

Quick-action chuck and electronic revolutions adjustment, with feedback effect (high engine power in the lower revolutions area). Special, balanced, low noise DC motor with high life expectancy. A mains adapter is required for operation. Other technical specifications and design same as for the left mentioned MICROMOT 60/E.

NO 28 512

Model building and engraving set. Complete with MICROMOT drill/grinder 60/E, mains adapter and 34 bits and cutters of dental quality.

MICROMOT drill/grinder 60/E (as described on the left). The set includes 34 industrial respectively dental quality bits and cutters:

1 diamond grinding bit, 1 fine miller, 0.5 and 1mm micro-drills, 1 brass brush, 4 high-grade corundum grinding bits (cylinder, sphere, disc and cone shaped), 1 polishing pad, 4 grinding wheels (2 corundum, 2 silicon carbide), 20 cutting discs and 1 arbor. The 6 MICROMOT collets ranging from 1 – 3.2mm (description on page 6) are also included. With mains adapter for 230V operation (12V, 1A).

NO 28 515



Set is packed in an attractive plastic case, with 34 industrial respectively dental quality bits and cutters.



*Reasonably priced and indestructible 12 Volt tools, made in EU.
Powered by MICROMOT mains adapters with power rating from 2A.*

Precision drill grinder FBS 12/EF

For precision drilling, milling, sanding, polishing, brushing, de-rusting, engraving, chiselling and cutting.

Includes keyless chuck (capacity 0.3 – 3.2mm). A precision ball bearing minimises spindle side play. Spindle lock button for bit changing obviates the need for spanners. Recessed spindle head for inserting MICROMOT steel collets (see page 6).

Special, balanced, low noise DC motor with high life expectancy. Variable speed control with feedback effect (high engine power in the lower revolutions area). Housing of glass fibre-reinforced POLYAMIDE.

Technical data:

Direct voltage 12 – 18V. 100W. Stroke 3,000 – 15,000rpm. Length 185mm. Weight 450g.

NO 28 462

Note: For operation of FBS 12/EF and STS 12/E we recommend the use of MICROMOT mains adapters with a power rating of at least 2A (see page 21).

Jig saw STS 12/E



Ideal for curved sawing of wood (up to 10mm), printed circuit boards (up to 3mm), and non-ferrous metal (up to 2.5mm).

With powerful special DC motor. Variable speed control with feedback effect. Housing of glass-fibre reinforced POLYAMIDE. With additional ball adapter for working on convex and concave surfaces.

Is exchanged for the normal saw table by unscrewing a screw. Including 2 saw blades (coarse and fine).

For replacement saw blades see page 9.

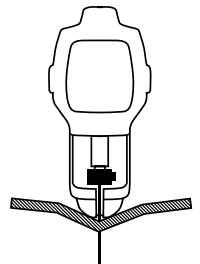

Technical Data:

Direct voltage 12 – 18V. Maximum power consumption 100W. Stroke 6mm (adjustable from 2,000 – 5,000rpm). Length 180mm. Weight 480g.

NO 28 534

MICRO-screwdrivers

Precision screwdriver for electronic engineers, camera builders, watchmakers, jewellers, precision engineers and model makers.

Shafts of high alloy nickel-chrome-molybdenum (SAE 8660) for maximum hardness and toughness. Chromed with brinelled tip. The ergonomically formed plastic handles are oil and impact resistant. The revolving top and finger mould improve ease of use.

- ⊖ Slot: 1 x 50, 2 x 50, 3 x 50
- ⊕ Phillips: PH 000 x 50, PH 0 x 50, PH 1 x 50
- ⊕ TX: T 5 x 50, T 6 x 50, T 8 x 50, T 10 x 50, T 15 x 50
- ⊖ Allen-key: 1.5 x 50, 2 x 50, 2.5 x 50, 3 x 50

NO 28 148 15 pieces in a stand

Note:

It is important to use the MICRO screwdrivers with care and feel. The brute force associated with larger screwdrivers is best left for other tools. The revolving top and finger mould improve ease of use.

Fixed place for each item in the practical holder. May be used as desktop stand or fixed to a wall.



Pensander PS 13

Ideal for working on surfaces in recesses, slots and small corners.

Linear (not rotating) stroke. Long-lasting special DC motor. Housing of glass-fibre reinforced POLYAMIDE. Four sanding arbors with straight shanks and four angled (all different shapes) as well as three sheets of pre-profiled self-adhesive sanding pads are included. The sheets are of grits 180, 240 and 400 with 5 of each shape per sheet.



Technical data:

Direct voltage 12 – 18V.
8,000 linear strokes/min.
(2.5mm stroke length).
Length 160mm. Weight
130g.

NO 28 594

Note:

For operation a mains adapter with a power rating of at least 1A is required. We recommend MICROMOT mains adapters NG 2/S, NG 2/E or NG 5/E (see page 21).



Additional sandpaper for PS 13

Three sheets, each with 20 pads in different shapes. Silicon carbide, self-adhesive.

- NO 28 822** 180 grit
- NO 28 824** 240 grit
- NO 28 826** 400 grit

MICRO screwdriver MIS 1

For torques of 0.35 – 2Nm. Due to rocker switch for on/off/reverse also ideal for cutting threads.

Small, light and easy to handle. A chuck facilitates acceptance of all bit shanks of and up to 6.5mm (also for standard 1/4" bits). Housing of glass-fibre reinforced POLYAMIDE. Complete with 16 inserts of chrome molybdenum steel.

Technical data:

Direct voltage 12 – 18V. 50W. Torques of 0.35 – 1Nm (the sixth stage bypasses the clutch and yields approx. 2Nm). Length 200mm. Weight 415g. We recommend the use of MICROMOT mains adapters with a power rating of at least 2A.

NO 28 690

The depicted mains adapter MICROMOT NG 5/E is not included.



Note:

Together with the drilling device BV 2000 the MIS 1 is a problem solver for cutting threads (see page 50!).

- Slot: 0.3 x 1.5 / 0.35 x 2 / 0.4 x 2.5mm
- + Phillips: Size 0 and 1
- ✦ TX: T 6, T 8, T 10
- Allen key, internal: 3 – 3.5 – 4 – 4.5 – 5mm
- Allen key, external: 1.5 – 2 and 2.5mm



The ideal complete starter kit including the tried and tested engraving tool GG 12!

Complete engraving kit with "trial glass".

Engraving kit GG12 with special balanced, powerful, quiet and long-lasting DC motor.

Housing of glass fibre-reinforced POLYAMIDE. Plus mains adapter, trial glass, motifs and instruction booklet as well as all necessary bits: 1 and 1.8mm diamond grinding bits with spherical head for engraving and line work, silicon carbide grinding bits in both conical and bullet shape for frosting glass as well as one corundum grinding bit in ball and cylinder shape for grinding and engraving. Including bit holder usable for holding MICROMOT rotating bits. Complete with mains adapter 0.5A for 230V.

Technical data for GG 12:

Direct voltage 12 – 18V. 20,000rpm. Length 145mm. Weight 50g (without cable).

NO 28 635

Engraving tool GG 12, available individually

Includes 1 diamond bit (spherical head, 1.8mm). For operation a mains adapter is required. We recommend MICROMOT mains adapters NG 2/S or NG 2/E.

NO 28 592



12 VOLT



Every piece has its own place in the attractive, extremely durable plastic storage case.

MICROMOT flexible shafts with precision aluminium handle. Optionally available with steel collets or quick-action chuck.

MICROMOT Flexishaft 110/P



Dual ball-bearing milled steel shaft with tool holder for MICROMOT steel collets. Ball-bearing shaft end on machine. Highly flexible core (does not run hot when working on tight radii). Length 100cm. For a maximum of 25,000rpm. Includes 6 steel collets (1 – 1.5 – 2 – 2.4 – 3 and 3.2mm).

NO 28 620

MICROMOT Flexishaft 110/BF



As described above, but with 0.3 to 3.2mm quick-action chuck. Practical when working with different shaft diameters.

NO 28 622



MICROMOT mains adapters: safe and efficient power sources for MICROMOT low-voltage tools.

MICROMOT mains adapter NG 2/E



Note:

Power consumption of hand-held power tools is measured according to the internationally accepted ICE-745-1 specification. The current drawn is measured, not the power consumption with a hot motor just before stalling. In practice, this condition seldom appears, if ever. All PROXXON mains adapters are suitably dimensioned for the recommended purposes.

The adapters do not include the illustrated mill/drill units.

NORYL casing (heat resistant – a necessity for transformer enclosures).

Polarised socket for MICROMOT plug. Red LED indicates readiness for use. PTC (Positive temperature coefficient) element prevents overload (and plugged in tool will not automatically restart). After cooling down the mains plug should be disconnected briefly to reset the adapter. With holes for storing bits. Foldable tool rest provides a secure place for keeping the MICROMOT tools at the ready. Variable speed control with feedback effect for adjusting bit speed to suit the job, as well as providing high torque at low speeds.

Technical data:

230V. Operational voltage 12V at 2A and 16V off-load voltage. Weight 1,000g. Class 2 insulation.

NO 28 707

MICROMOT mains adapter NG 2/S

Without electronic speed control, otherwise exactly as mains adapter NG 2/E.

NO 28 706

MICROMOT mains adapter NG 5/E

In compact NORYL casing (heat resistant – recommended for transformers).

Variable speed control with feedback effect for optimum tool speed and high torque at low speeds. Three polarised sockets for MICROMOT machines. A pair of sockets for standard banana plugs (4mm diameter) is also supplied. Master switch for turning off the transformer without needing to unplug. Red LED indicates 'ready'. PTC (Positive temperature coefficient) protection against overload (plugged in machine will not restart automatically. After cooling down, the mains plug should be unplugged to reset the adapter). With storage holes for tools with 2.35mm and 3mm shafts. Foldable tool rest for the MICROMOT tool.

Technical data:

230V. Operational voltage 12V at 4.5A and 16V off-load voltage. Weight 2,000g. Class 2 insulation.

NO 28 704





MICROMOT drill stand made of die-cast aluminium parts. With CNC-machined guides and fits. A whole different world.



MICROMOT drill stand MB 200

Head with dovetail guides can be tilted through 90° (scale ring available). Enables bevelled drilling and versatile milling operations.

Geared rack and pinion feed with return spring allowing effortless and sensitive operation. Practical drill depth scale with adjustable limit stop (maximum travel 40mm). With standard 20mm collar for MICROMOT drilling and milling devices. With solid, hard chromium-plated steel column (280 x 20mm), throat capacity (column inside to centre of tool) 140mm.

Plane-milled table (220 x 120mm) with parallel limit stop and scale. Drilled, tapped holes for securing the MICRO compound table KT 70 and holes to fix the drill stand itself are also provided. Weight 2.2kg.

NO 28 600

Note:

Our designers prefer die-cast aluminium. A refined, rust-proof and statically solid material. Fittings and feeds are machined on our highly modern CNC-controlled machines (milled, line-bored, lathed, etc.). Pure precision!

Machine vice MS 4

Die-cast zinc.

With three machined sides. The slot fits the adjustable fence of the drill stand MB 200 as well as the bench drill machine TBM 220. Horizontal and vertical V-slots in jaw. Jaw width 50mm and height 10mm. Maximum clamping width 34mm.

NO 28 132

MICROMOT tool holder

For stationary use of MICROMOT electric precision tools with metal head in combination with a vise. Especially suited for industrial drill/grinder IBS/E, belt sander BS/E, longneck angle grinder LHW, super jig saw STS/E and delta sander OZI/E. Made of glass-fibre reinforced POLYAMIDE.



NO 28 410

Universal holder UHZ

With ball joint. Can be rotated and swivelled in all directions.

20mm collar for MICROMOT drilling and milling devices, such as FBS 240/E, FBS 12/E, IBS/E, LBS/E, MICROMOT 60, 60/E and 60/EF.

Made of die-cast ZINC. With clamp for quick and secure fastening to workbenches and table tops up to 60mm thickness. Alternatively, it can also be fixed to any workplace with 2 standard screws.

NO 28 610



MICRO compound table KT 70

Made of solid aluminium with surface treatment and fitted with adjustable dovetail gibs and three T-slots of the MICROMOT standard (12 x 6 x 5mm). Adjustable ruler eases workpiece positioning. Both handwheels have zero-resettable dials with graduations indicating 1 revolution = 1mm and 1 division = 0.05mm. The clamps and securing bolts for the MB 200, MB 140/S and TBM are included.

Other technical data:

Table size 200 x 70mm. X travel 134mm and Y travel 46mm, maximum height 43mm.

NO 27 100

Step clamps made of steel

The step clamps set is supplied with the KT 70, but can also be ordered separately. Set consists of 2 stepped blocks and clamping jaws threaded bolts, screw nuts and slot nuts of the MICROMOT standard. For workpieces up to 20mm thickness.

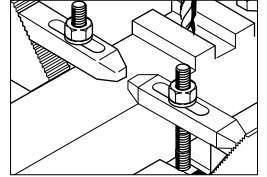

NO 24 256

Note:

The MICRO compound table KT 70 is now also available as KT 70/CNC-ready (with two stepping motors for the axes X (transverse) and Y (lengthwise). You will find it on page 52.

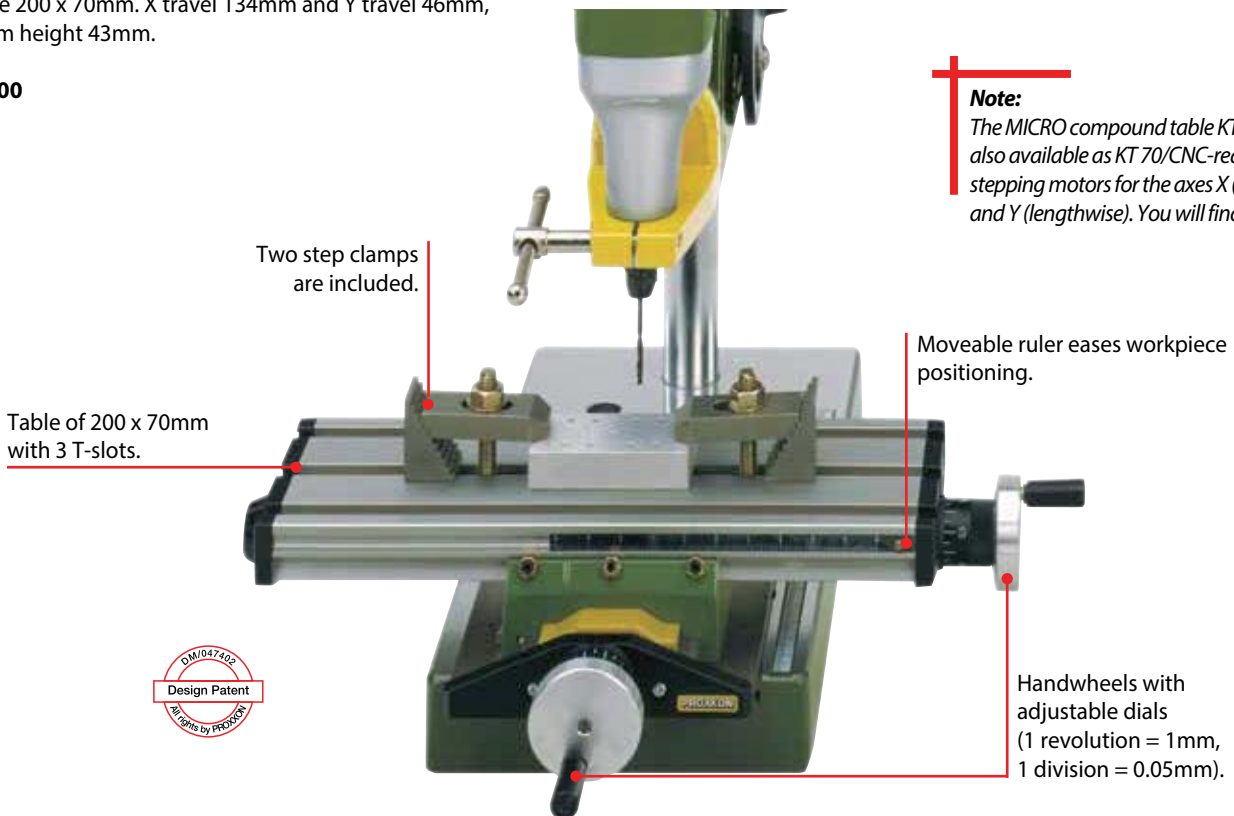

Precision vice FMZ with integrated clamp

Rotates in all directions. Made of die-cast zinc.

Easily clamps to workbenches and tables of up to 60mm. Alternatively, use 2 standard screws to secure to the work surface. Ball and socket: rotates in all directions (even downwards). 75mm jaws with protective covers (for delicate workpieces). Maximum clamping width 70mm and weight 1.6kg.

NO 28 608

Precision vice FMS 75

As detailed above, but without clamp.

A strong suction cup facilitates instantaneous fixing to any smooth, flat surface.

NO 28 602



Bits and cutters for MICROMOT drills and mills of industrial and dental qua

Wolfram vanadium milling bits

For
non-ferrous
metals
plastic
plaster

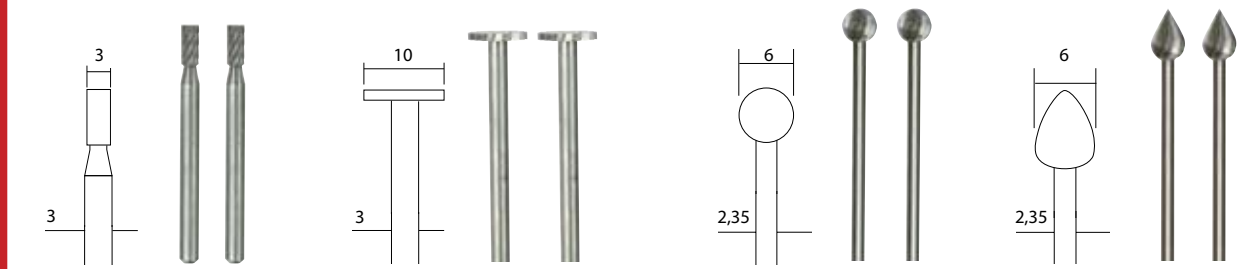

NO 28 722

2 pieces

NO 28 727

2 pieces

NO 28 725

2 pieces

NO 28 724

2 pieces

Wolfram vanadium steel milling bits Selected wolfram vanadium steel. Purpose-made stable construction with head and shaft out of a single continuous metals, as well as plastics and plaster of Paris. All shafts Ø 2.35 or 3mm. Ideal for milling, routing, shaping, profiling and slotting. For clean and

HSS drill bits

For
metal
plastic
wood

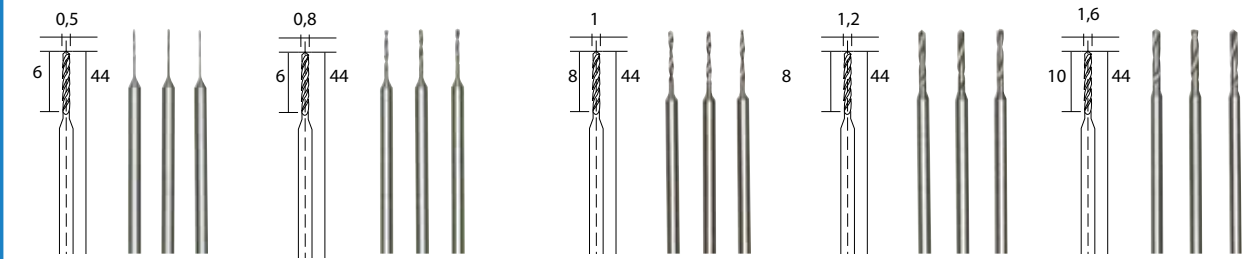

NO 28 864

3 pieces

NO 28 852

3 pieces

NO 28 854

3 pieces

NO 28 856

3 pieces

NO 28 858

3 pieces

HSS drill bits. Selected steel quality. Purpose-made stable construction with high concentricity. Shaft and bit are manufactured from a one-piece blank. High hardness for optimum life expectancy and elasticity. For drilling metal, non-ferrous metals, plastic, PC cards and wood. Work speeds: soft materials approx. 8,000rpm, hard materials approx. 3,000rpm. Ø shanks 2.35.

Tungsten carbide drills and milling bits

For
steel
glass
circuit boards

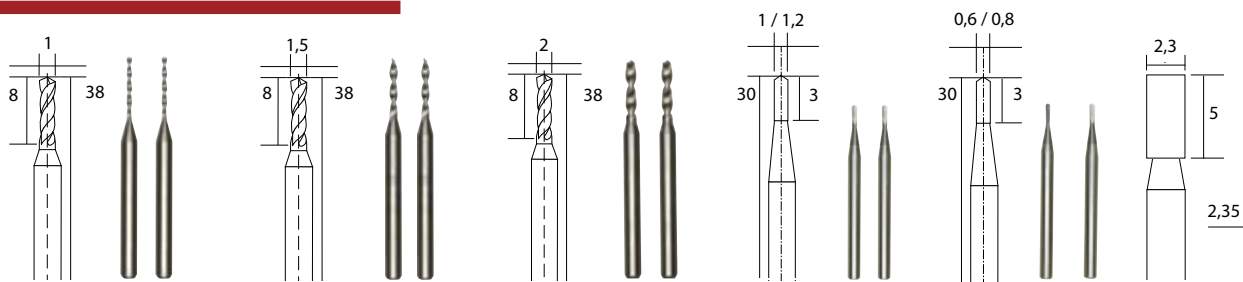

NO 28 324

2 pieces

NO 28 326

2 pieces

NO 28 328

2 pieces

NO 28 320

2 pieces

NO 28 321

2 pieces

NO 28 750

2 pieces

Tungsten carbide drills Made of wear-resistant tungsten carbide. For drilling glass, semiprecious stones, porcelain, ceramics, marble and other hard stones. The hard stones are subdivided according to the degree of hardness from 1 – 10. Tungsten carbide can be used up to hardness degree 6. Drilling hard stones with a hardness degree of more than 6 calls for the use of diamond tools. Shaft Ø 3. With ideal cutting angle of 6°.

Tungsten carbide milling drills (spear drills). For drilling, milling and cutting fibre glass or PERTINAX circuit boards. Also for drilling pearls and similar. Shaft Ø 2.35.

Tungsten carbide Made of wear-resi secure workpieces work, for engraving

Note:

MICROMOT steel collets are hardened and thus have a high, consistent flexibility. ① They also maintain prolonged accuracy, even after regular use (these collets should not be compared with unhardened, four-slit collets of brass and aluminium). The triple slit collet is substantially more difficult to manufacture than the four-slit type, ② but offers a better load-bearing surface. This is especially important for ③ cutters with small shaft diameters.



MICROMOT steel collet set



Triple slit and hardened. 1 each of 1 – 1.5 – 2 – 2.4 – 3 and 3.2. With clamping nut and holder for storage (see note at left). **NO 28 940**

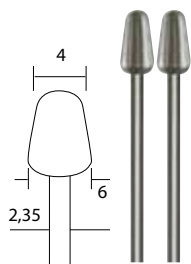

NO 28 723

2 pieces

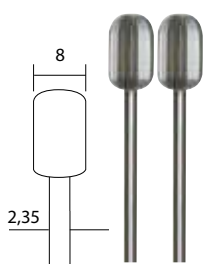

NO 28 726

2 pieces

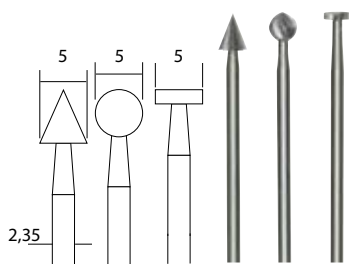

NO 28 720

3 pieces

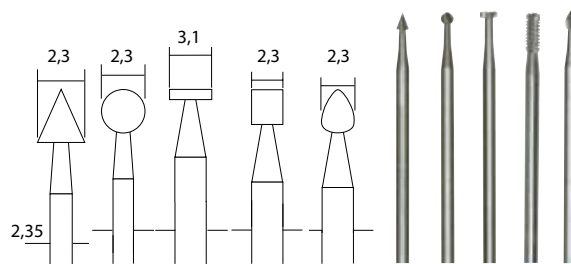

NO 28 710

5 pieces

blank. The precise flutes and optimal concentricity ensure best life expectancy. Ideal for free-hand precision work. For use on hard and soft woods, non-ferrous and pre-powerful fitting of the milling bits we recommend the use of MICROMOT steel collets as described above. See bottom left.



NO 28 876

6 pieces
HSS twist drill set with centring pin in storage case 6-piece set \varnothing 1.5 – 2 – 2.5 – 3 – 3.5 - 4.. For precision tapping of wood and plastics; also non-ferrous metal, steel and stainless steel sheets. Titanium coating reduces friction and increases service life. Shaft \varnothing 3, 6-piece set.

Note:

The term HSS for this tool category comes from the utilised drill material. High speed steel (HSS) is a high alloy tool steel extremely resistant to wear due to its manufacturing process and is dimensionally stable up to approx. 600°C.

Cutting oil or coolant emulsion should be used as cooling lubricant, when machining steel. Spirits or petroleum should be used for aluminium. Normally, plastic and wood can be dry-machined.



NO 28 874

10 pieces
HSS twist drill in storage case 10-piece set. Similar to DIN 338 \varnothing 0.3 – 0.5 – 0.8 – 1 – 1.2 – 1.5 – 2 – 2.5 – 3 – 3.2. For drilling non-ferrous metal, steel and stainless steel. In labelled cassette with fold back and stand function. For clamping we recommend our 3-jaw drill chuck (see below).

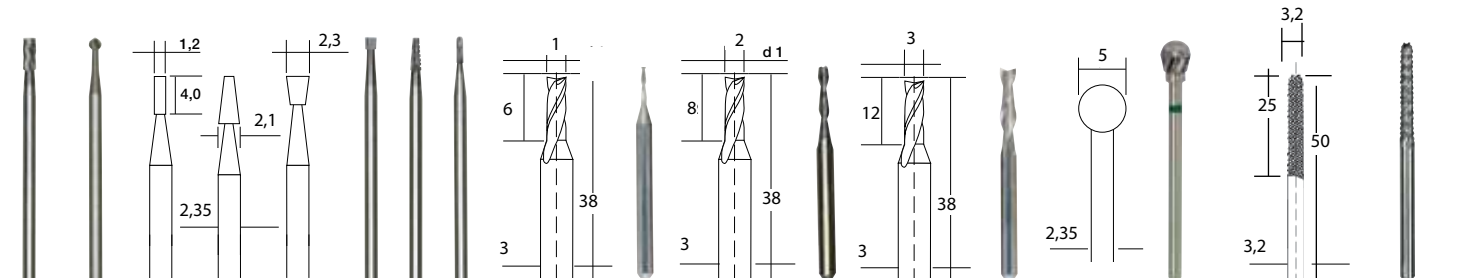

NO 28 752

3 pieces

NO 28 758

NO 28 759

NO 28 761

NO 28 760

NO 28 757

millers

stant highly compressed fine-granular tungsten carbide. Used for vibration-free milling of high accuracy dimensions. It is advisable to well, avoiding accidents. For milling steel, cast steel, non-ferrous metals, plastics and extremely hard materials. May be used for technical and milling of PC cards. Shafts \varnothing 3 or 2.35. Here also we recommend the use of MICROMOT steel collets.

Rasp cutter

For cutting and milling tiles, stoneware, wood and plastics.

Drill chuck or collet ?

Drill chucks provide more convenience to quickly change the tools when working with shafts of varying diameters (e.g. HSS drills as per DIN 338). However, because of their technical setup, they have a few drawbacks compared to collets: Less clamping force and higher concentricity tolerances. If high precision is necessary, then working with MICROMOT steel collets is a must. See also note at left.

Three-jaw steel drill chuck



For all MICROMOT devices designed for use with chuck. Advantageous when working with different shafts. Capacity 0.3 - 3.2. **NO 28 941**

Tungsten milling cutters, 3 pieces

Two flute cutters and a fishtail profile ensure cutting to the centre, allowing boring. Usable on grey cast iron, hardened cast iron, steel, cast steel, brass, aluminium, glass and even plastics and carbon fibre. One each of 1 – 2 and 3mm. 3mm shaft diameter. Can also be ordered separately (see above).



NO 27 116

Diamond, cleaning and polishing tools. In professional quality, also for

Diamond tools

For
glass
ceramics
plastic

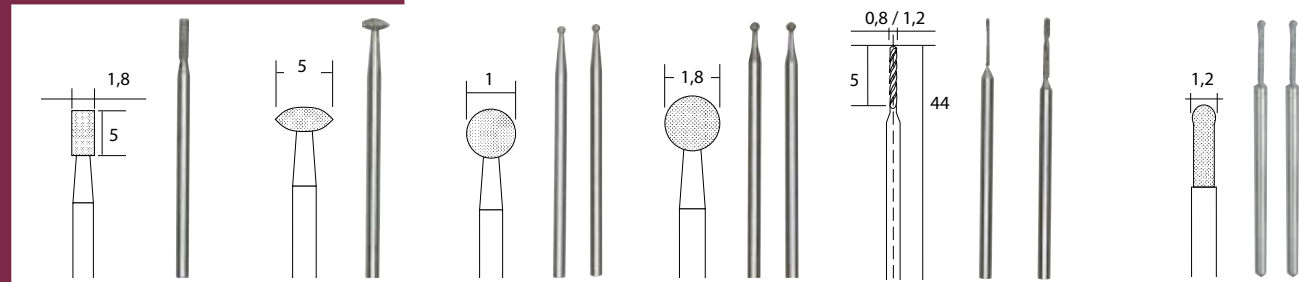

NO 28 240

NO 28 250

NO 28 212

NO 28 222

NO 28 255

NO 28 230

2 pieces

2 pieces

2 pieces

2 pieces

Diamond grinding bits With consistently even coating of diamond dust. Bodies and shafts made from stainless steel. Used for grinding, engraving and chiselling steel (even chrome-cobalt alloy), glass, ceramics, porcelain and plastics. All shafts \varnothing 2.35.

Diamond twist drills

For drilling holes in (semi) precious stones, etc. Shaft \varnothing 2.35.

Ball-shaped dia
ing and machini
ended for use
of coolant. Shaft

Cleaning brushes

For
steel
brass
stainless steel

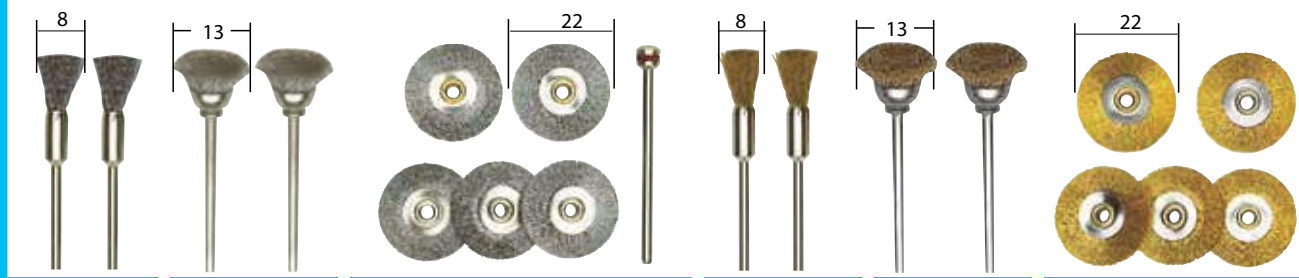

NO 28 951

NO 28 953

NO 28 952

NO 28 961

NO 28 963

NO 28 962

2 pieces

2 pieces

5 pieces

2 pieces

2 pieces

5 pieces

Steel brushes, cups and wheels High quality components for best operation. For cleaning, removing rust, sanding, frosting, roughening, rounding-off, etc. of metal, cast iron, plastic, stone and wood. Shaft of \varnothing 2.35.

Brass brushes, cups and wheels Ideal for working on brass, brass alloys, copper, precious metals, semiprecious stones, plastic and wood. For cleaning of electronic components and circuit boards. Shaft of \varnothing 2.35.

Polishing agents

For
gold
stainless steel
porcelain

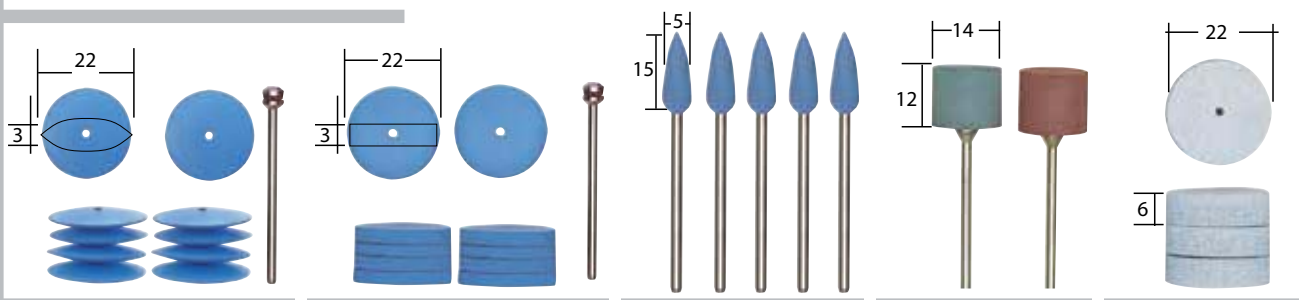

NO 28 293

NO 28 294

NO 28 288

NO 28 295

NO 28 296

10 pieces

10 pieces

5 pieces

2 pieces

4 pieces

Flexible silicon discs, wheels and bullets

Used for surface smoothing and polishing of precious metals, non-ferrous metals, high-grade metals, glass, porcelain, wood, rubber and plastic. The bullets are very suitable for working tough-to-reach insides. Shafts of \varnothing 2.35.

Flexible polishing pad set

Especially suitable for working gold, platinum, silver as well as for tool making and castings. Shafts of \varnothing 2.35.

Special polishing discs

For surface smoothing and polishing of the cutting edges of Perspex and plexi-glass. With arbor \varnothing 2.35.

10-piece HSS wood router cutter set



One each: Slot cutter \varnothing 3.2 – 4.8 and 6.5, rounding over cutter \varnothing 6.4, V-slot cutter \varnothing 6.5, combi cutter 6.5/2.5, core box bit R 3.2, rebating cutter 6.4, edge cutter with pin 5, angle cutter 45°. Neatly packed in wooden box.

You will find individual wood router cutters on page 35.

NO 29 020

Note:

In addition to carving with the motorised carving machine MSG the wolfram carbide rasp plate is a useful accessory for wood carvers for use with our longneck angle grinders LHW and LHW/A. See page 8.



jewellers and for the jewellery industry!

Note:
All measures are in mm.

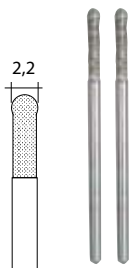

NO 28 232

2 pieces

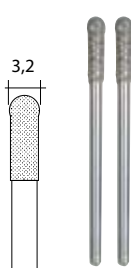

NO 28 234

2 pieces



NO 28 840

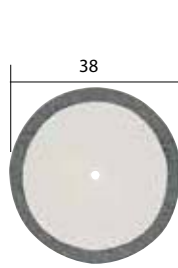

NO 28 842



NO 28 844

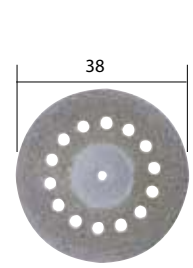

NO 28 846

Diamond-coated grinding bits for glass and stone For drilling of glass and types of stone reaching to granite. Recommendation drill presses with a speed of 2,000rpm with the addition of 2.35.

Diamond cutting discs
Only 0.6 thick. For cutting and sanding of porcelain, ceramics, glass fibre boards, plastic and non-ferrous metals. Shaft of Ø 2.35.

Diamond-coated cutting discs with cooling holes
For cutting, grinding and deburring. Same application as described on the left. Less heating up due to cooling holes. No burn marks! Shaft Ø 2.35.



NO 28 955

2 pieces



NO 28 957

2 pieces

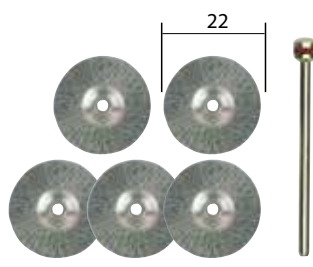

NO 28 956

5 pieces

Stainless steel brushes, cups and wheels For cleaning, brushing and cleansing stainless steel. Remove cinders and scales on stainless steel welding seams and soldering points. Can also be used on aluminium and non-ferrous heavy metal. Shaft Ø 2.35.

Note:
Permit the brushes to work only with gentle contact pressure and at the recommended rotational speed! If the pressure is too high, the individual wires will be bent too strongly and afterwards straighten up again due to the centrifugal force. This excessive flexural fatigue stress of the wires on their seating promotes the notch effect. They are prone to breakage!

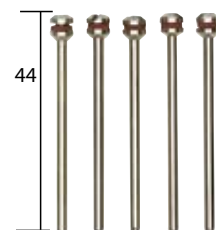

NO 28 815

5 pieces

Spare arbors
Shaft 2.35 x 44.

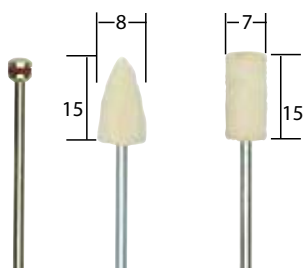

NO 28 801

2 pieces

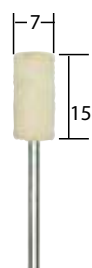

NO 28 802

2 pieces

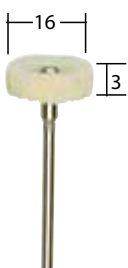

NO 28 803

2 pieces



NO 28 798

10 pieces



NO 28 297

2 pieces



NO 28 298

2 pieces



NO 28 299

2 pieces



NO 28 292

Felt polishers and felt discs
For preliminary and high burnish polishing of metal, gold, silver, brass and aluminium with the use of polishing paste. Also for final polishing in mould and die-making. Shaft Ø 2.35. Work with a lower rotational speed when polishing. Soften hard polishing paste with oil or heat up lightly.

Cotton, chamois and felt polishers For high burnish polishing of metal, gold, silver, non-ferrous metals, brass, aluminium, ceramics and porcelain with the use of polishing paste. Also for reconditioning painted woods and plastics. Shaft Ø 2.35.

Polishing paste
Absolutely essential for polishing metal and plastic.

Rasp cutter with wolfram carbide burrs

For sculpting, cleaning and smoothing wood and fibre glass. The material can be removed precisely and without physical effort. High stability and easy to clean with a Bunsen burner. Also for use on rubber, foam and silicone. Shafts Ø 3.2.

Do not use on metal!



NO 29 060 Ball nose cylinder 7.5 x 12

NO 29 062 Cone 8 x 12

NO 29 064 Taper 4 x 19

Holder for bits and cutters

For the clean storage of micro drills, grinding bits, brushes and other rotating tools with shaft diameters of 2.35 – 3.2. Without bits and cutters.



NO 28 359 2 pieces

Selected cutting, sanding and polishing bits for professional use and long

Abrasives

For
steel
stainless steel
cast iron
wood

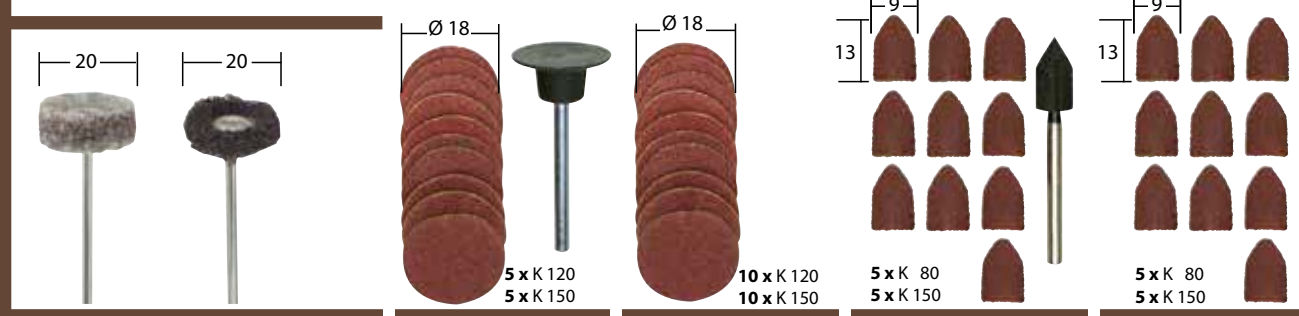

NO 28 282

2 pieces
Nylon fleece brushes for cleaning, frosting and sanding steel, stainless steel, non-ferrous metals, etc. Shaft \varnothing 2.35.

NO 28 982

10 pieces
Sanding discs, caps and bands are made of standard corundum. The sanding compounds have a different application areas. For sanding, smoothing and polishing of malleable cast iron, grey cast iron, to the material to be sanded. Steel high, wood medium and plastic low rotational speed. Sanding bands

NO 28 983

20 pieces
10 x K 120
10 x K 150

NO 28 987

10 pieces
5 x K 80
5 x K 150

NO 28 989

10 pieces
5 x K 80
5 x K 150

Grinding points and discs

For
steel
cast iron
HSS steels

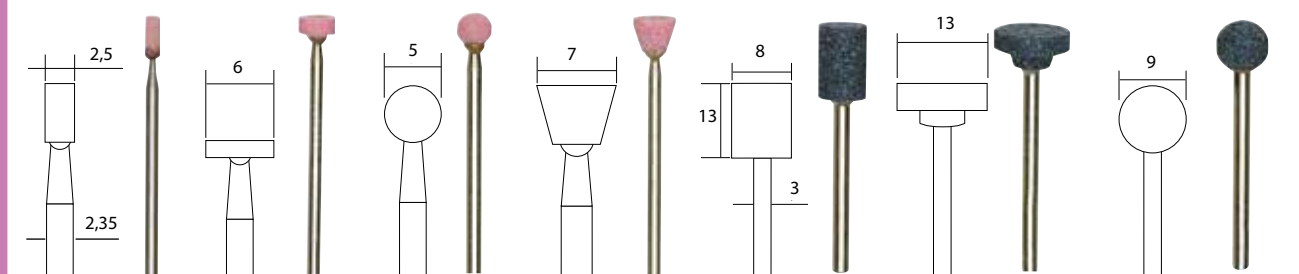

NO 28 774

5 pieces

NO 28 776

5 pieces

NO 28 772

5 pieces

NO 28 778

5 pieces

NO 28 781

3 pieces

NO 28 783

3 pieces

NO 28 782

3 pieces

High quality corundum grinding bits Bits and sets of fine, high quality materials of consistent hardness. Various shapes for the widest possible range and chiselling hard materials such as cast iron, cast steel, malleable cast iron as well as hard metal alloys and refined steel. Accurately dimensioned ensure maximum concentricity. **Grinding rule:** soft materials = hard grinding bits; hard materials = soft grinding bits!

Cut-off wheels

For
wood
steel
stainless steel

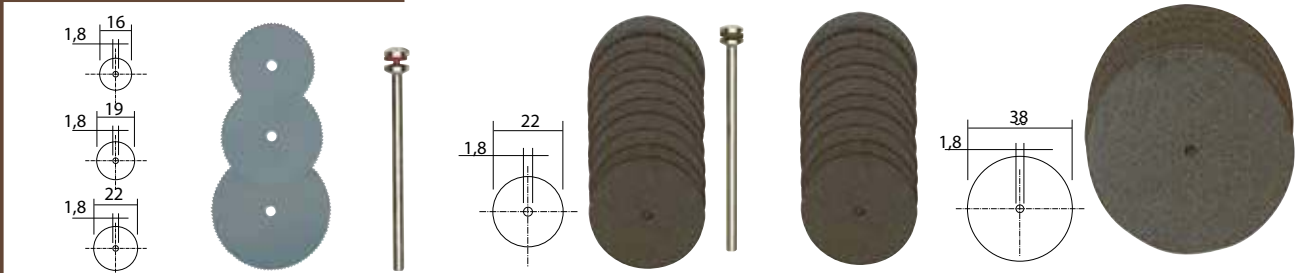

NO 28 830

3 pieces

Cutting blades made of spring steel 0.1mm thick. For plastic, wood and non-ferrous metal. Shaft \varnothing 2.35. For free-hand work use of the protective device 28 944 (see bottom right)!

NO 28 810

10 pieces

Corundum cutting discs

Discs made of a special compound of diameter 22 or 38 x 0.7mm. Used to part alloys and metals, metals. Can also be used for cutting wood and plastic. Shaft of \varnothing 2.35.

NO 28 812

50 pieces

NO 28 820

5 pieces

Cut-off wheels

For
wood
fibre-reinforced
plastics

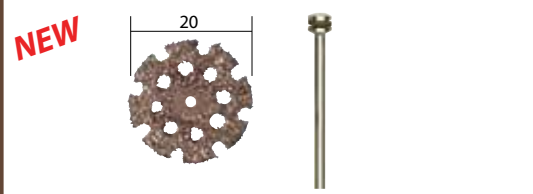

NO 28 838

Tungsten carbide cutting disc. Thickness approx. 2. For cutting and profiling wood, CFK, GRP, rubber, silicone. Cooling holes reduce heating up. Shaft \varnothing 2.35.

13-piece set for model makers

One 2.3 ball-shaped and cylinder shaped fine milling bit each. One each ball-shaped and cone-shaped white corundum grinding bit. One each 1 and 2.3 micro drill. 5 cutting discs \varnothing 22. One saw blade \varnothing 22 (only in combination with the protective device 28 944) and arbor \varnothing 2.35.



NO 28 910

Best life expectancy!

Note:
All measures are in mm.

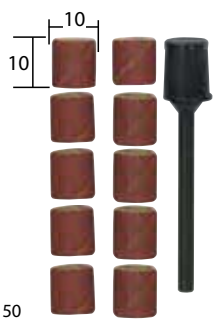

K 150
NO 28 980

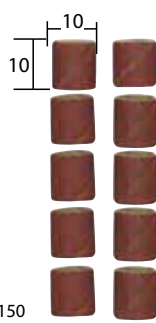

K 150
NO 28 981

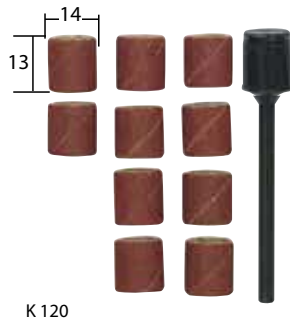

K 120
NO 28 978

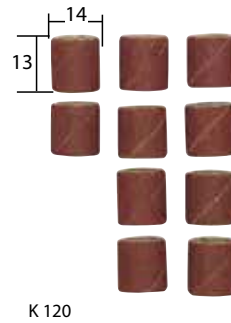

K 120
NO 28 979



K 120
NO 28 984

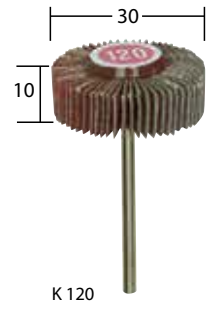

K 120
NO 28 985

10 pieces tough consistency and different grits for preliminary and refining work. Extreme toughness. Different versions for stainless steel, steel, non-ferrous metals, wood and plastic. Can also be used for chamfering. Adapt the rotational speed and caps can also be used for refining radii and grooves. Shaft \varnothing 3.

Flapwheels of standard corundum are elastic and adapt to the contours of the work piece being processed. For machining inaccessible spots. Shaft \varnothing 3.

Grinding points and discs

For glass ceramics tungsten carbide



NO 28 302
10 pieces of applications. For grinding sioned shafts of \varnothing 2.35 or 3

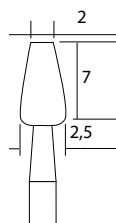

NO 28 270
2 pieces
Silicon carbide grinding bits Fine particles of consistent hardness for engraving and frosting of glass, ceramics and stellites. Also for grinding tungsten carbide, chilled cast iron and other hard steel alloys. Shafts \varnothing 2.35.

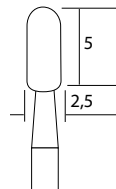

NO 28 272
2 pieces

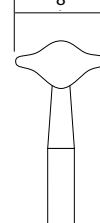

NO 28 304
10 pieces



NO 28 821
25 pieces
stainless steels and non-ferrous

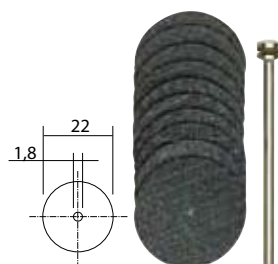

NO 28 808
10 pieces
Aluminium oxide cutting discs with reinforcement
The cutting discs are available in \varnothing 22 x 0.8 and \varnothing 38 x 1. Nearly unbreakable, making them usable to remove stock. Will cut alloyed, standard and stainless steels, non-ferrous metals and even wood and plastic. Arbor shaft of \varnothing 2.35.



NO 28 809
50 pieces

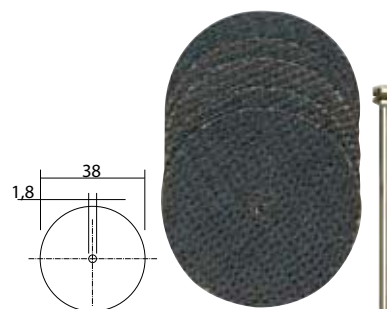

NO 28 818
5 pieces



NO 28 819
20 pieces

4-piece glass working set

2 diamond grinding bits and 2 silicon carbide grinding bits. For engraving, grinding or frosting glass. Diamond bit 1: ball \varnothing 1, diamond bit 2: ball \varnothing 1.8, silicon carbide bit cone 3/2 x 5, and bullet 2/2.5 x 7. All shafts \varnothing 2.35.



NO 28 920

Complete polishing set, 10 pieces

For polishing metal, glass, precious metals, porcelain and plastic. Consisting of 3 felt polishing bits (cylinder, cone and wheel shapes), 3 silicon polishing bits (bullet, cylinder and disc shape), cotton polishing disc, chamois buffing wheel and polishing paste. Includes 2.35 x 44 arbor.

NO 28 285



*Light, compact MICROFLAM burners for fine work.
 Fitted with electronic piezo crystal lighter.*

MICROFLAME burner MFB/E



Used for soldering, de-soldering, brazing, heating of workpieces, tinning.

Individually controllable gas and air supply. Super fine flame shape with temperature attaining 1,200 °C. Ideal for precision work. Fitted with an electronic piezo crystal lighter.

The tank contents of 50ml suffices for approximately 60 minutes operating time with normal flame. For fill-up use standard butane cartridges for lighters.

NO 28 146

MICROFLAM gas soldering set MGS



A practical stainless steel base also enables stationary work.

For working with open flame or with catalyst unit in combination with adapters. For soldering, hot-cutting, woodburning and shrinking of sleeves.

Electronic piezo crystal lighter with safe on/off-gas flow switch. Individually controllable gas and air supply. Hard-soldering of delicate parts with flame temperatures up to 1,300 °C. When working with tips up to 500 °C. Large gas tank (20ml) for long continuous work. Refillable with standard butane cartridges for lighters.

Adapter tips: large wax/varnish-scraping knife for repairs in wood, hot knife for cutting even thicker plastic foil, 2 woodburning tips (angled and flat pointed), a soldering tip, a round nozzle for hot air work as well as one for heat-shrinking sleeves.

Also included: Soldering tin, drip tray with sponge and 7mm open-end spanner for tightening the adapter tips. Packed in plastic case with sturdy PP tray. Each piece finds its place!

NO 28 144





For shrinking sleeves (many devices available on the market are simply too large) and 1000 kinds of other applications.

MICRO heat gun MH 550



Small, robust and powerful. Complete with 3 additional nozzles.

For shrinking sleeves, shaping and welding plastics, soldering and de-soldering of electronic components. For removing layers of paint and varnish without aggressive chemicals (pickling agents). For drying and accelerating curing processes (adhesives, paints). For applying and removing films (stickers). For browning wood.

Housing of glass fibre reinforced POLYAMIDE with soft components in the grip area and footprints for stationary use. A powerful heating element ensures a consistent temperature in 2 stages with an air flow of approx. 180l/min. Installed thermostat as security against overheating.

Technical Data:

230V. 500W. Air temperature in Stage 1: 350 °C. Stage 2: 550 °C. Air volume approx. 180l/min. Weight approx. 500g.

NO 27 130

MICROMOT glue gun HKP 220

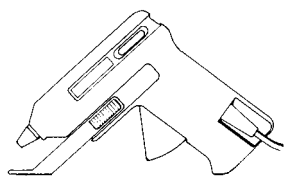

Quick and reliable gluing of metal, wood, plastic (including Plexiglass), glass, ceramics, stoneware, cardboard, leather, polystyrene foams and textiles. Depending on the material and on the adhesive quantity applied, the adhesive sets after about 30 seconds, allowing positional corrections within this period of time (impossible with

instant glues). The 7mm glue sticks are perfect for delicate work such as model building, toy and jewellery making, dried flower arrangements, etc. Sensitive mechanical feed ensures correct glue quantity delivery. Integral stand positions gun on worktop when not in use. Short heating time.

Technical data:

230V. PTC controlled element for exact temperature of 200 °C. Four glue sticks 7 x 100mm and 3 interchangeable metal nozzles are included in the set.

NO 28 192



Including 3 interchangeable metal nozzles.

Replacement glue sticks for HKP 220



For metal, wood, plastic, ceramics, cardboard, leather, polystyrene foams and textiles. Ø 7mm. Length 100mm. Colourless.

NO 28 194

12 pieces

Hot wire cutter THERMOCUT 650

NEW



Flat support surface and lateral bore to fix the included screw clamp allow also stationary use.

Telescopic arm for adjustable cutting lengths from 400 – 650mm. Cutting depth (throat capacity) 200mm.

Spring element in support bracket ensuring constant wire tension regardless of temperature based wire expansion.



Switching power supply for 230V connection. The heating element is operated with a safety voltage of max. 40V and 1.2A. Depending on the material the cutting wire temperature is pre-selected using the practical control knob and remains stable while working. Supporting surface with lateral bore for fixing a screw clamp to allow for stationary use. A screw clamp and a spool with 30m of cutting wire Ø 0.2mm are included in the scope of delivery.

Technical data:

230V. 50/60Hz. 50W. Secondary voltage max. 40V, 1.2A. Cutting temperature of wire Ø 0.2mm continuously variable from 100 – 350 °C. Weight 850g. Insulated to Class 2.

NO 27 084

Replacement cutting wire

for THERMOCUT 650, THERMOCUT 230/E and other similar hot wire cutters. Made of NiCr 8020. Spool of 30m x 0.2mm.

NO 28 080



Hot wire cutter THERMOCUT 12/E

For use with thick cutting wires (285 x 0.85 mm) that can be formed by hand or pliers to produce any profile.

Stable frame with pivotable fixing element at top and extendable lower wire fixing. Infinitely variable cutting wire temperature. Heat-up time 1 second. Complete with five formable cutting wires 285 x 0.85mm.

Technical data:

12V. 60W. Cutting wire temperature continuously variable from approx. 150 – 350 °C.

NO 27 082

Replacement cutting wire

For the THERMOCUT 12/E. Easy to bend, therefore ideal for modelling.

NO 28 082 10 pieces

Important note:

For operation of the THERMOCUT 12/E a mains adapter with a power rating of at least 2A is required. We recommend MICROMOT mains adapters NG 2/S (NO 28 706) (see page 21).



rior to other tools. No crumbling as when working with knife or saw.
and, not least, for classical model building.

Hot wire cutter THERMOCUT 230/E

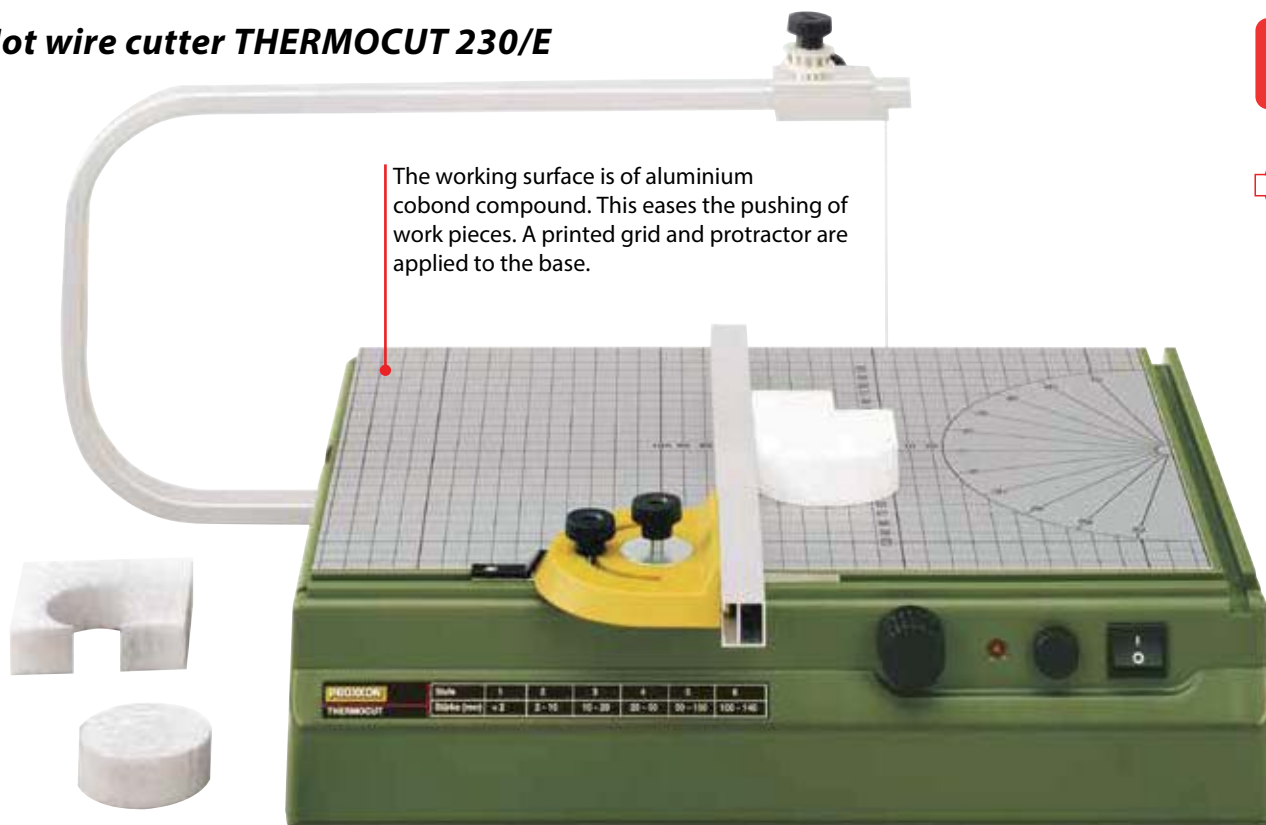

The large base with 390 x 280mm table with surface of aluminium cobond compound ensures smooth and easy movement of the workpiece. The printed grid and protractor ease division and cutting. The solid aluminium overarm has a 350mm throat and offers 140mm capacity in height. The holder and wire coil (30m, 0.2mm diameter is included) may be shifted along the overarm to enable mitre cutting. A LED indicates operation and prevents burnt fingers (the cutting wire heats to maximum in less than 1 second).

Other technical data:

230V, 50/60Hz. Transformer secondary max. 10V, 1A. Cutting wire temperature with 0.2mm diameter is variable between approx. 100 and 200 °C. Weight approx. 3kg. Insulated to class 2 requirements.

NO 27 080

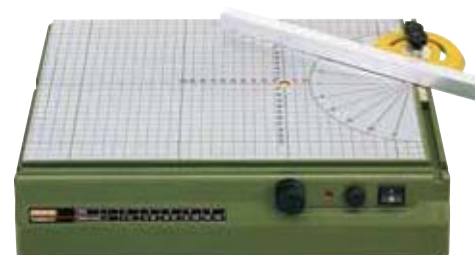

Double function fence with lockable feed bar
(German Patent 100 00 102.5).

Replacement cutting wire

For use with THERMOCUT 230/E and other similar units.
Made of NiCr 8020. Spool of 30m x 0.2mm.



NO 28 080

Note:

You will find the right temperature (depending on material and thickness) with a bit of instinct and practice. The optimum cut is usually achieved at medium temperatures and without too much pressure.

Styrofoam is an inexpensive material and very environmentally friendly compared to other materials. This material is sold in standard sheet sizes of 50 x 100cm and thicknesses of 2 to 16cm in almost all DIY centres and hardware stores.



Crosscuts are achieved by means of a simple yet efficient solution: secure drawing-pin to table by means of tape, it serves as a fixed centre.



MICRO woodturning lathe DB 250

Turning in miniature is a pleasing hobby.

One can make glasses, cups, saucers, vases and columns for a doll house. In model trains, one can make lighting masts, windows, tanks. Limbs for marionettes and hundreds of classical miniature turning tasks may be carried out with ease. The electronic speed



control assists in the lower range in a 'semi-automated' painting process.

Technical data:

Motor 230V. 100W. 50/60Hz. Centre distance of 250mm, 40mm swing. 25mm swing over support. Variable speed control covering between 1,000 and 5,000rpm. Headstock spindle bore of 10mm. Tailstock travel 20mm. Includes 6 collets (2 – 3 – 4 – 6 – 8 – 10mm), drive centre, live centre and face plate.

NO 27 020



Ball bearing spindle is bored through at 10mm.
For series production of small parts.

Square carrier with back centre and 10mm shaft.

The stable tool rest is adjustable in all directions.

Tailstock with quill travel.

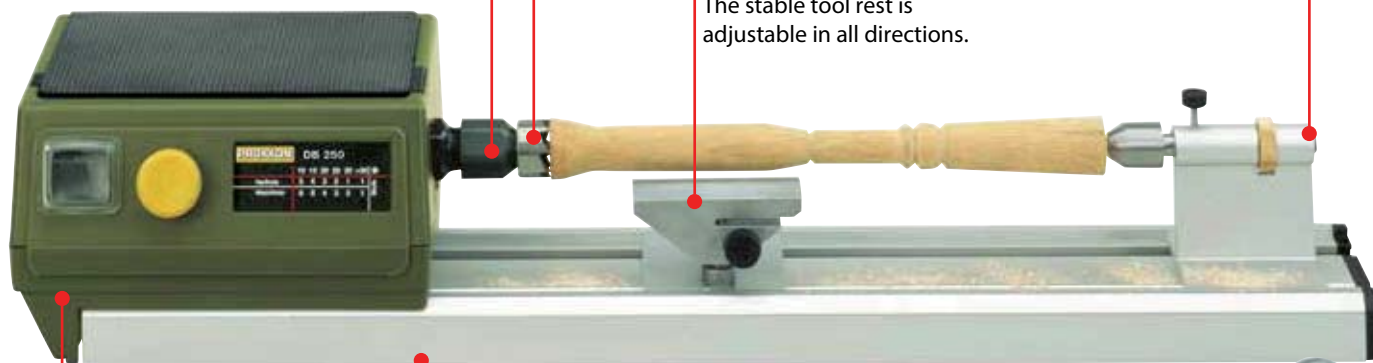

Powerful drive motor with speed control between 1,000 and 5,000rpm.

The bed is made from stable, thick-walled aluminium profile.



Six collets and a face plate (for turning larger work pieces) are included.

Five piece HSS chisel set

A high quality set with the most frequently used turning tools: beading tool, gouges 3mm and 6.4mm, parting tool and scraper. Neatly packed in a wooden box.

NO 27 023



Drill chuck with sliding sleeve for the tailstock of the DB 250

Clamps up to 5mm. Is inserted on the spot of the rotating back centre. The feed movement results from sliding the complete tailstock.

NO 27 028



Independent four jaw chuck for the DB 250. With individually adjustable jaws.

Used to clamp asymmetrical pieces such as rectangles. The reversible jaws clamp from 1.5 – 35mm (inside) and from 14 – 67mm (outside). The DB 250 headstock spindle of thread M16 x 1 screws directly into the chuck.

NO 27 024



Three jaw chuck for the lathe DB 250. Used for concentric clamping.

Made from steel and offering 1.5 to 20mm and 12 to 50mm when reversing the jaws. The chuck has a M16 x 1 thread for fitting directly to the DB 250 headstock spindle.

NO 27 026

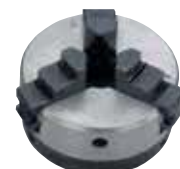



For precise machining of edges and longitudinal cuts in wood, fibreboard and suitable plastics.

MICRO shaper MP 400

For chamfering, cutting grooves, slots, recesses, radii and other profiles. For crafting picture frames and for separating. Also enables exact manufacturing of edges and longitudinal cuts (for model building, e.g. for doors, flaps and housing parts). Powerful dust-protected motor with toothed belt drive. Double ball-bearing spindle. Tool holder with triple slit precision collets (one each of 2.4 – 3 and 3.2mm are included). Milling cutter height adjustment by hand wheel. Stable aluminium table with longitudinal and angle stop as well as cutter guard.

Adapter for vacuum cleaner fits standard household vacuum cleaners. Three HSS router cutters (slot cutter 3.2mm, V-slot cutter and core box bit) are included.

Technical data:

230V. 100W. 50/60Hz. 25.000/min. Height adjustment with scale ring adjustable to 0 (1 revolution = 1, 1 graduation = 0.05mm). Milling table 300 x 150mm. Weight approx. 2kg.

NO 27 050

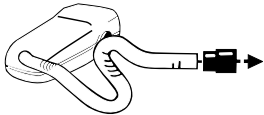

The MP 400 is fitted with a dust collection channel and vacuum adapter.



Three tungsten carbide router cutters and three collets are included.

HSS wood router cutters

For wood and fibreboard. Clean relief grinding for good work results and surface finish. High stability. Shafts 3.2mm.

- NO 29 024** slot cutter Ø 3.2mm
- NO 29 026** slot cutter Ø 4.8mm
- NO 29 028** slot cutter Ø 6.5mm
- NO 29 030** Rounding over cutter Ø 6.4mm
- NO 29 032** V-slot cutter Ø 6.5mm
- NO 29 034** Combi cutter 6.5/2.5mm
- NO 29 036** Core box bit R 3.2mm
- NO 29 038** Rebating cutter 6.4mm
- NO 29 040** Edge cutter with pin 5mm
- NO 29 044** Angle cutter 45°

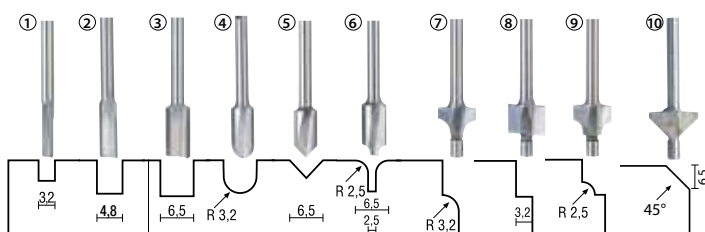

HSS 10-piece wood router cutter set

1 piece each of the cutters offered here. Neatly packed in wooden box.

NO 29 020



Attention:

The wood router cutters offered here may only be used with machines that have a safety mechanism. For example MICRO shaper MP 400 or router base OFV (page 14).



Bench circular saw KS 230

The 'Super-Cut' saw blade (Ø 58mm) cuts soft wood up to a thickness of 8mm.

Low noise and persevering AC motor with high life expectancy. Power transmission by toothed belt ensures the right blade speed for the job with approx. a doubling of torque. Cutting performance in wood up to 8mm, plastics (also PERTINAX printed circuit boards) up to approx. 3mm, non-ferrous metals up to approx. 1.5mm.

Even fibreglass reinforced PC cards can be cut by using a carbide saw blade. Adjustable mitre fence with scale. Angle stop with degree graduation. Flat-milled worktop of die-cast aluminium (160 x 160mm).

Technical Data:

230V. 85 W. 8,000rpm. Weight approx 1.8kg.
NO 27 006

Diamond blade. 50mm diameter (10mm bore).

With 0.5mm layer of class 'D107' diamond for cutting ceramics, porcelain, tiles, stone as well as PC cards.

NO 28 012



Tungsten tipped circular saw blade

50mm Ø x 1.1mm (10mm bore). 20 teeth.

For extremely clean cuts of balsa, plywood. Can also be used for cutting PC cards and POLYCARBONATE.

NO 28 017



Crosscut 'Super-Cut' blade 58mm diameter (10mm bore).

80 alternately set teeth. Ideal for hard and soft wood as well as plastic and Pertinax. For fast, clean cuts. Teeth are individually set and sharpened. Superior cutting power!

NO 28 014



Saw blade made of high-alloy special steel (HSS). Ø 50mm (10mm bore), 0.5mm thick. Alloy holding a high proportion of tungsten, vanadium and molybdenum for an even structure, high hardness and long lifetime. Fine-toothed (100 teeth). For very fine cuts in non-ferrous metals (aluminium, brass, copper). Also suitable for cutting compound materials like PC cards, and sawing wood and plastics.

NO 28 020



Solid carbide saw blade

50mm diameter (10mm bore). 0.5mm thick. Fine toothed (80 teeth): ideal for cutting fibreglass sheets up to 3mm, non-ferrous metals, duro-plastics and other 'difficult' materials.

NO 28 011



Note:

You will find the larger version of the circular saw KS 230 (type FET) on pages 42/43.

'Super-Cut' blade (Ø 58mm), 80 teeth, individually set and sharpened, is included.

Adjustable fence with scale.

Graduated mitre stop.

Machined, die-cast aluminium table of 160 x 160mm.

Motor: low noise and persevering for prolonged use.

Base of ABS with a sawdust door on the right.

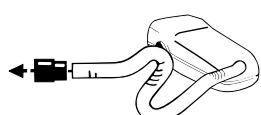
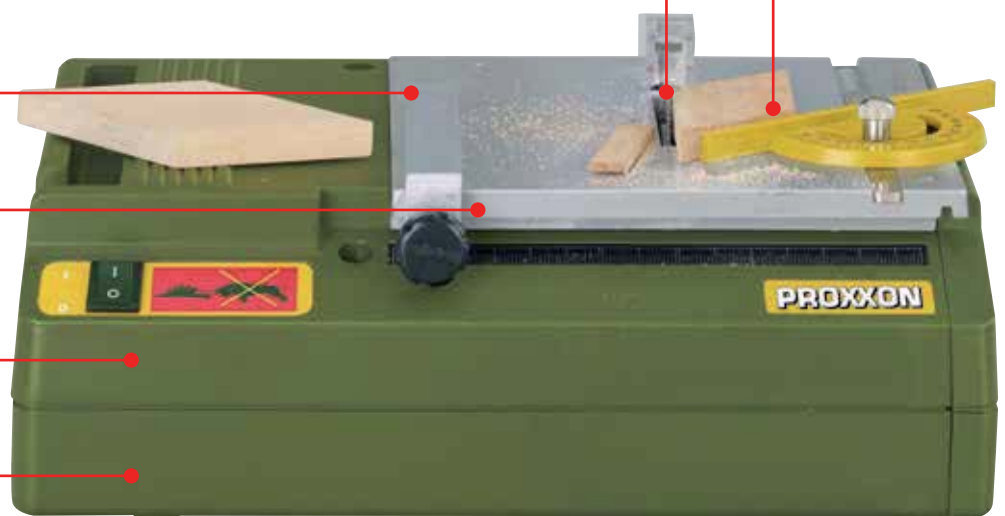

*Very important when sawing:
use our vacuum cleaner adapter for a cleaner
work environment.*





Cuts aluminium, wood, PC cards and plastics with standard scroll saw blades. With electronically controllable stroke rate.

Scroll saw DS 230/E



Adjustable head (patent EP 09783341) offers many advantages (see below).

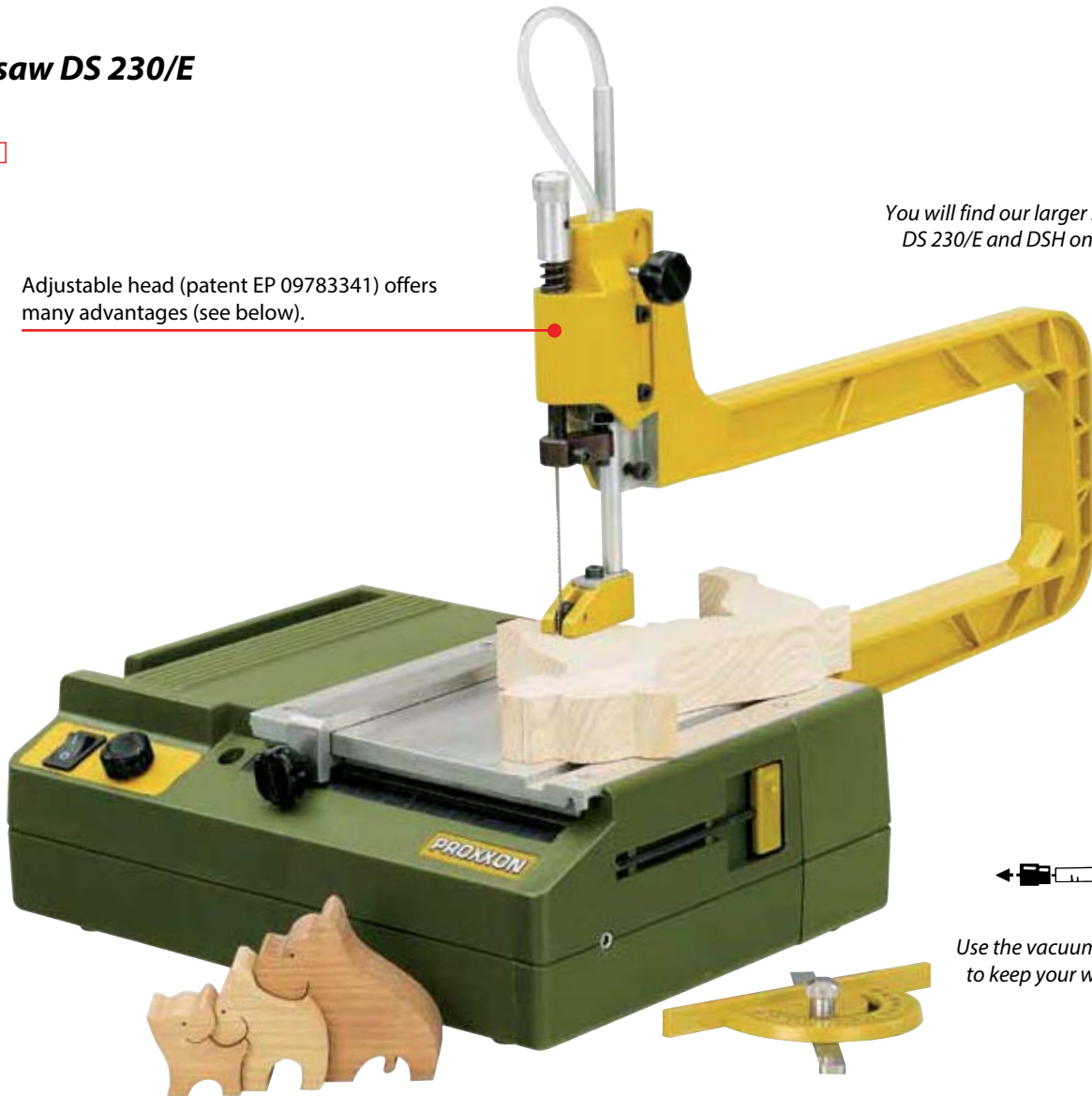

Note:
You will find our larger scroll saw models DS 230/E and DSH on pages 40 and 41.

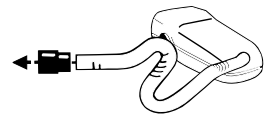

Use the vacuum cleaner adapter to keep your work area cleaner.

The ideal machine for the delicate job: model building, toy making and precision mechanics. With electronic speed control.

Cuts soft wood up to 40mm, hard wood up to 10mm, plastics (including PC cards) up to approx. 4mm and non-ferrous metals up to 2mm. Plane-milled die-cast aluminium table (160 x 160mm). Saw frame with 300mm throat made from very stable ribbed die-cast aluminium. Blade guide with integrated blower. Height adjustable head (3 positions) offering two advantages:

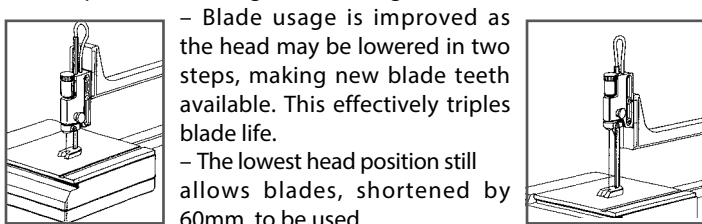

- Blade usage is improved as the head may be lowered in two steps, making new blade teeth available. This effectively triples blade life.
- The lowest head position still allows blades, shortened by 60mm, to be used.

Low noise and persevering AC motor with high life expectancy. Quiet and wear-resistant drive via toothed belts. Adjustable mitre fence and angle stop with scale. Includes 5 saw blades (3 coarse-toothed and 2 fine-toothed).

Technical Data:

230V. 85W. Electronically controllable stroke rate from 150 – 2,500rpm. Weight approx 2kg.

NO 27 088

'Super-Cut' scroll saw blades. High quality steel for extended use and prolonged cutting capacity. Standard version without pin.

Hard and soft woods, plastic, Perspex and soft non-ferrous metal.

Coarse-toothed blades NO 28 116	No. 9: 14 teeth per 25mm 130 x 1.5 x 0.48mm	12 pieces
Standard-toothed blades NO 28 117	No. 5: 17 teeth per 25mm 130 x 1.20 x 0.38mm	12 pieces
Fine-toothed blades NO 28 118	No. 3: 20 teeth per 25mm 130 x 0.8 x 0.34mm	12 pieces

Hard materials such as steel and PERTINAX.

Standard-toothed blades NO 28 112	No. 5: 36 teeth per 25mm 130 x 0.85 x 0.4mm	12 pieces
Fine-toothed blades NO 28 113	No. 3: 41 teeth per 25mm 130 x 0.75 x 0.36mm	12 pieces
Very fine-toothed blades NO 28 114	No. 1: 50 teeth per 25mm 130 x 0.6 x 0.3mm	12 pieces

Grinding and polishing machine SP/E



The dust collector and vacuum cleaner adapter can be used.

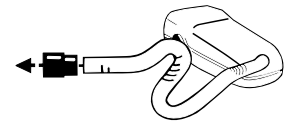

The slim housing facilitates the grinding of long workpieces and includes an adapter to connect a vacuum cleaner to the unit.

The tool rests and eye guards are both adjustable. A spindle lock eases the changing of wheels and discs. Supplied with a 50 x 13mm corundum (grade N) and silicon carbide (soft compound) wheel for general grinding/sharpening and hard materials respectively.

The right hand spindle accepts the polishing arbor, which is supplied as standard equipment.



NO 28 030

Technical data:

230V. 3,000 - 9,000rpm. Wheels 50 x 13 x 12.7mm. Grinding speed 8 - 24m/sec. Weight approx. 1,200g. Size approx. 250 x 130 x 100mm.

Polishing set

Steel wire brush for de-rusting and cleaning steel and non-ferrous metals. Brass wire brush to polish non-ferrous metals and precious metals. Felt wheel is used on painted surfaces and the chamois and cotton wheels provide a high gloss finish on non-ferrous metals and precious metals.



NO 28 312 Complete set

Spare discs for the SP/E and BSG 220 (50 x 13mm)

Corundum (grade N) with 12.7mm bore
NO 28 308

Silicon carbide with 12.7mm bore. Soft compound for very hard materials.

NO 28 31

Cut off saw KG 50

Accurately cuts small items of metal, wood and plastic.

Table moveable through 45°, allowing mitre cuts. Workpiece is fastened tightly and accurately by means of the integrated clamping device. Clamp jaws 27mm wide and maximum workpiece diameter 20mm. Depth of cut to 13mm. A special slot is provided to clamp HO model tracks.

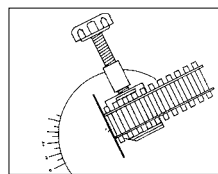

The fence accepts lengths up to 140mm. Five ceramic cutting discs 50 x 1 x 10mm are also included suitable for cutting steel, non-ferrous metals as well as wooden or plastic rods.

Technical Data: 230V. 85W. 50/60Hz. Peripheral speed 20m/sec. Weight approx. 1.5kg.

NO 27 150

Replacement cutting discs

Made of ceramic compound: 50% aluminium oxide and 50% silicon carbide. Suitable for cutting steel, non-ferrous metal as well as small wood and ceramic bars.

NO 28 152



Note:
You will find the larger version of the KG 50, our Cut off/mitre saw KGS 80, on page 47!



For surface treatment of precious and non-precious metals and also plastics. For standard brushes and inserts up to 4" or 102mm.

Polishing machine PM 100



Shaft drive via toothed belt: The motor no longer limits the working area. The slim housing around the main shaft even enables machining the surface of very long and variously shaped work pieces.

Load bearing side parts made of aluminium with milled bearing seats enable very quiet low-vibration operation.

With long, ball bearing mounted main shaft (distance from disc approx. 360mm) and adjustable protective guards to work cleanly with polishing pastes. Powerful drive through DC motor with speed control (full-wave electronics). For high starting torque and enormous traction even during strong contact pressure. Firm mounting with screws, but also with the attached screw clamp in horizontal or vertical position.



Included with the original equipment:
1 each stiff and soft muslin polishing wheel (100 x 15mm) and 1x universal polishing bar (80g).

Technical data:

230V. 140W. 50/60Hz. Variable speed of 1,000 – 3,100rpm. For polishing discs up to a max. of 4" or Ø 102mm. Size L 360, W 220, H 250mm. Weight approx. 5kg. Insulated to class 1.

NO 27 180

Accessories for polishing machine PM 100

Muslin polishing wheel, stiff (100 x 15mm)



Impregnated and especially stiff. For preliminary and shine polishing of gold, silver, platinum, copper, brass, stainless steel and plastic. Use only with polishing paste or polishing emulsion.

NO 28 000

Muslin polishing wheel, soft (100 x 15mm)



For high shine polishing of gold, silver, platinum, copper, brass, stainless steel and plastic. Adapts to the workpiece contour. Use only with polishing paste or polishing emulsion.

NO 28 002

Universal polishing bar (80g) made from polishing compound and wax



Particularly suitable for polishing and high shine polishing of precious and non-precious metals as well as plastic. Also for freshening tarnished aluminium, copper or brass.

NO 28 008

Felt cloth polishing disc (100 x 15mm)



For high shine polishing of smooth surfaces on metals (e.g. gold, silver, brass, and aluminium). High lateral stability and durability. Very even polishing results. For use with all polishing pastes.

NO 28 004

Microfibre polishing wheel, 15-ply (100mm)



Very soft. For shine polishing of precious and non-precious metals as well as plastic. Especially suitable for spots difficult to access which cannot be reached with rigid discs. Use only with polishing paste or polishing emulsion.

NO 28 006



460mm throat! Extremely light magnesium saw arms reduce the by approx. 40% compared to die-cast aluminium. For smooth run

2-speed scroll saw DS 460



Extremely important: A handy adjusting knob enables sensitive clamping of the saw blades!

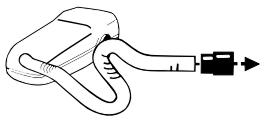

The DS 460 is equipped with a suction connection with vacuum cleaner adapter. For dust-free and clean working.

Note:

You will find the scroll saw DS 230/E, ideal for delicate projects, on page 37!

Sturdy construction: Vibration-reducing base housing of cast steel, neatly CNC-processed and powder-coated. For stability and working without vibrations.

Magnesium saw arms precisely mounted on bearings: Extremely light and firm with a slender-shaped cutting area for an unobstructed view of the work piece. Chip blowing device with adjustable nozzle. Additional suction connection to connect a vacuum cleaner.

Large saw table made of die-cast aluminium (400 x 250mm). For easier saw blade replacement, it can be unlocked and pushed back (see description at top right). Regular scroll saw blades are fastened by saw blade holders with high clamping force: This ensures true alignment in the saw arm! The machine has also been prepared for saw blades with pin ends that are used without blade holders. Extremely important for these types of scroll saws: A handy adjusting knob enables sensitive clamping of the saw blades!

Table angle adjustment possible from 5° to 50° (see bottom right).

Cutting performance in wood 60mm, in non-ferrous metals (depending on type) 10 - 15mm. Also easily cuts Plexiglas, glass fibre reinforced plastic, foam, rubber, leather or cork. Includes 5 each coarse and fine saw blades.

Technical Data:

230V. Powerful, brushless 2-speed motor (205W). Throat 460mm. Stroke alternatively 900 or 1,400rpm. Saw stroke 18mm. Table size 400 x 250mm. Maximum work piece passage 65mm (at 45° mitre 32mm). L 580mm, W 320mm, H 300mm. Weight 20kg.

NO 27 094

Blade holders for DS 460
(one pair is already included with the machine).

For clamping regular saw blades with high clamping force: for true alignment of the saw arm.

NO 27 096 2 pieces



**weight of the mass moved
ing and clean cuts.**

**Easy saw blade replacement
without tedious fiddling by
pushing back the table!**

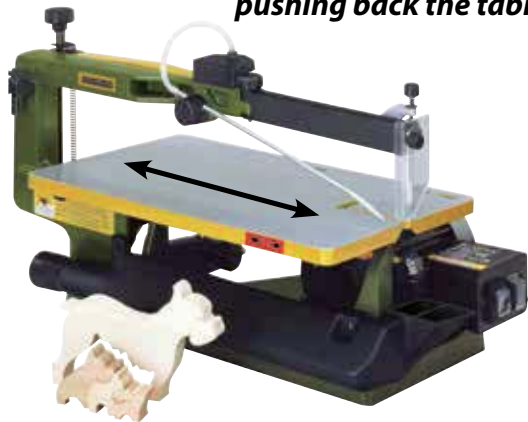

Innovative solution (patented): To enable easy saw blade replacement, the horizontally positioned table can be unlocked and pushed back by 80mm. For an unobstructed view of the bottom saw arm when fitting the saw blade holders or pin end blades.



Patented saw blade holders with high clamping force ensure true alignment of the saw blades. Recesses in the table surface serve as guide line in assembly to define position and distance of the saw blade holders.



Table angle adjustment possible from 5° to 50°. With large dimensioned serrations at 0°, 10°, 20°, 30° and 45°. Additional fine adjustment for precise mitre and angle cuts.

Standard scroll saw blades with pin ends. 127mm:



For cutting soft and hard wood, plastics as well as other soft materials and especially thicker work pieces. Coarse-toothed (10 TPI per 25mm):

NO 28 741 127 x 2.61 x 0.51mm 12 pieces

For cutting thin materials, soft and hard wood as well as plastics.

Normal toothed (18 TPI per 25mm):

NO 28 743 127 x 1.86 x 0.24mm 12 pieces

For cutting non-ferrous metals, glass-fibre reinforced plastics, plastics, Plexiglas and wood.

Fine-toothed (25 TPI per 25mm):

NO 28 745 127 x 1.76 x 0.25mm 12 pieces

Spiral blade. 130mm long with plain ends (without pins).



These blades cut all directions and obviate the turning of the workpiece (advantageous, especially with bigger workpieces). A 1.5mm hole is required. Ideal for plastic, hard and soft woods.

NO 28 747 125 x 1.2mm 12 pieces

“Super-Cut” scroll saw blades without pins. 130mm:

For cutting hard and soft woods, plastic, Perspex and soft non-ferrous metal.

Coarse-toothed blades

No. 9: 14 teeth per 25mm

NO 28 116 130 x 1.5 x 0.48mm 12 pieces

Standard-toothed blades

No. 5: 17 teeth per 25mm

NO 28 117 130 x 1.2 x 0.38mm 12 pieces

Fine-toothed blades

No. 3: 20 teeth per 25mm

NO 28 118 130 x 0.8 x 0.34mm 12 pieces

Hard materials such as steel and PERTINAX.

Standard-toothed blades

No. 5: 36 teeth per 25mm

NO 28 112 130 x 0.85 x 0.4mm 12 pieces

Fine-toothed blades

No. 3: 41 teeth per 25mm

NO 28 113 130 x 0.75 x 0.36mm 12 pieces

Very fine-toothed blades

No. 1: 50 teeth per 25mm

NO 28 114 130 x 0.6 x 0.3mm 12 pieces

**2-speed scroll saw DSH. The 10,000-fold proven
standard model with 400mm throat.**



Cutting performance 50mm in wood, 30mm in plastic, 10mm in non-ferrous metals.

For cutting Plexiglas, glass fibre reinforced plastic, foam, rubber, leather or cork. Slender saw arm of die-cast aluminium for unobstructed view from top. Air blower with adjustable air nozzle. Sturdy table of die-cast aluminium (360 x 180mm), can be tilted by 45° for mitre sawing. Base housing of cast steel for stability and working without vibrations. Includes 5 each coarse and fine saw blades.

Technical Data:

230V. Powerful, brushless 2-speed motor (205W). Stroke alternatively 900 or 1,400rpm. Stroke length 19mm. Throat 400mm. Maximum cutting depth 50mm, at 45° mitre 25mm. Weight approx. 17kg.

NO 28 092



*With set-screw for fine adjustment of the longitudinal stop by 1/10mm.
For precise, straight cuts without refinishing!*

Table saw FET



Extendable table extension with integrated auxiliary stop.

Setting screw for fine adjustment of longitudinal stop by 1/10mm.

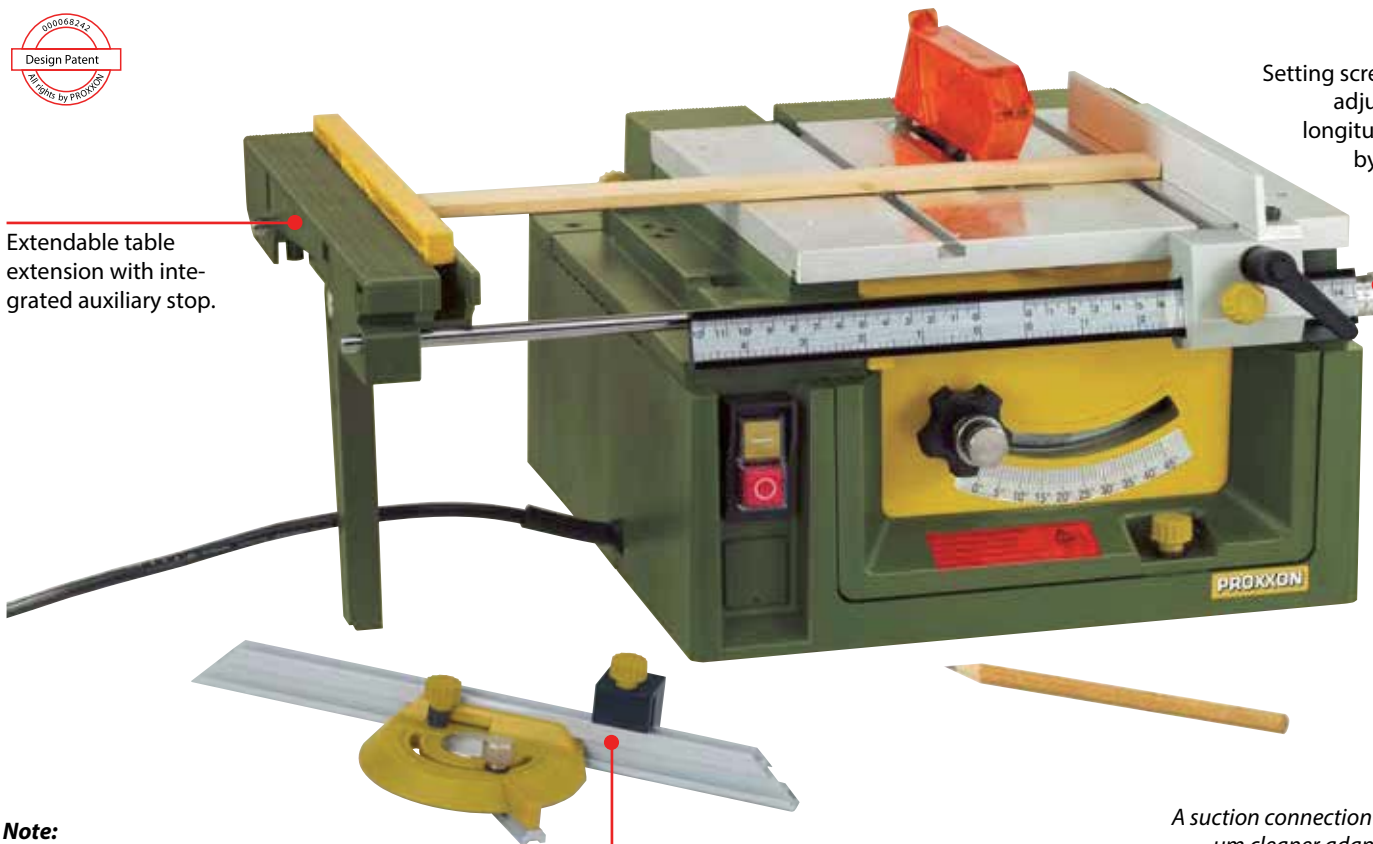

Note:
You will find the smaller version of the FET (circular saw KS 230) on page 36.

Angle stop with stop rail of aluminium and adjustable limit stop for manufacturing parts of equal length and the same angle.

A suction connection with vacuum cleaner adapter permits clean working with table saw FET and surface planer AH 80.

AH 80 and DH 40: The smallest and finest in the world!

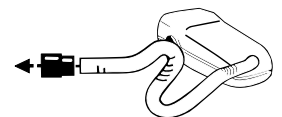

Surface planer AH 80

Supporting construction all made of die-cast aluminium with CNC-machined fits. Pre-condition for vibration-free, clean planing of soft and hard woods.

The heart of the machine: Ball-bearing mounted planer block with exchangeable HSS blades. Belt-driven by special low noise DC motor. Plane-milled table, of which the right table half is fine adjustable via toggle screw. Adjustable longitudinal stop, to both sides inclinable through 45° (scale available). Practical safety milling protection that does not interfere during work. Main switch with emergency-stop and restart protection. Including suction connection and push stick.

Technical data:

230V. 200W. 50/60Hz. Table 400 x 80mm. Planing width 80mm. Maximum chip removal (infeed) 0.8mm. Speed 6,000rpm. Weight 5.5kg. Insulated to class 1.

NO 27 044

Replacement planer blades for AH 80

HSS steel, 82mm long.

NO 27 046 2 pieces



Height adjustable tungsten-tipped saw blade, tilting through 45°.

For fine mechanics, model building, mould construction, toy manufacture, architects, model carpenters and fitters.

For cutting wood, non-ferrous metals, plastics, Plexiglas, glass fibre reinforced sheets, foam and many other materials. Stable construction because load bearing parts and plane-milled table are made of die-cast aluminium.

The micro-adjustable, precise and stable longitudinal stop provides decisive advantages: Corrections even smaller than 1/10 mm can be made after coarse adjustment using an adjusting screw. The height adjustable and 45° tiltable saw blade makes it possible to cut double mitres when used together with the angle stop.

Low-noise drive using DC special motor with Optibelt toothed belts. Ball-bearinged saw blade shaft. Tungsten tipped saw blade 80 x 1.6 x 10mm (36 T). Additional work piece pusher and non-slotted ABS sawing gap cover for tight tolerances between saw blade and table.

Technical data:

230V. 7,000rpm. Mitre infinitely adjustable up to 45°. Table size 300 x 300mm. Cutting depth 1 – 22mm. Saw blades between 50 - 85mm can be used (with 10mm centre hole). Weight approx. 6kg.

NO 27 070



Non-slotted sawing gap cover of ABS for tight tolerances between saw blade and table (is slotted from below by the FET saw blade). For cutting very small parts.



Table and drive can be lifted up and supported like an engine bonnet. For cleaning the device and easy saw blade replacement.

NEW

Super cut

Ø 85 x 0.5 x 10mm.
80 teeth. Use on hard and soft woods, plastics.



NO 28 731

Tungsten carbide tipped

Ø 80 x 1.6 x 10mm, 36 teeth. Use for balsa, plywood, soft and hard woods, POLY-CARBONATE, plastics, non-ferrous metals, glass-fiber reinforced circuit boards. **NO 28 732**



High-alloy special steel (HSS)

Ø 80 x 1.5 x 10mm, 250 teeth. Use on non-ferrous metals, soft and hard woods, laminates, GRP, CFK and composite boards.



NO 28 730

Diamond coated

Ø 85 x 0.7 x 10mm. Layer 'D100' Ceramics, porcelain, tiles, stone, CFK, CRP and epoxy circuit boards.



NO 28 735

Thickneser DH 40

Load bearing components are all made of die-cast aluminium, with milled seats for bearings and spindles.

These characteristics are essential for vibration-free, smooth thickening of soft and hard woods. Triple-spindled table (of die-cast aluminium, flat-milled) which can be accurately adjusted to 1/10mm by handwheel (zero adjustable). Automatic even feed with anti-kickback device: The knurled, spring-mounted infeed roller transports even irregularly shaped work pieces. A rubber-coated outfeed roller prevents marking the newly planed surface. Precision planer block with two HSS planer blades.

Technical Data:

230V. 200W. 50/60Hz. Thickening up to 40mm thick and up to 80mm wide. Maximum depth of cut 0.8mm. Cutter speed 6,000rpm. Feed rate 4.8m/min. Table length 232mm. Weight approx. 8kg.

NO 27 040

Spare blades

For thickneser DH 40. Made of HSS. Length 82mm.

NO 27 042

1 pair



Disc sander TG 125/E



With associated horizontal C-clamp (with table), but can also be fixed vertically quickly and safely (to sharpen tools).

Suction channel with adapter to connect a vacuum cleaner.



Plane-turned sanding disc (125mm) made of die-cast aluminium, covered with silicone film. This allows for effortless removal of sanding discs after use.

Table tilting through 50° downwards and 10° upwards. With angle stop. With C-clamp for horizontal and vertical fixing (see figure above).

For all wood types, steel, non-ferrous metals, precious metals, plastics (also Plexiglas and glass-fibre reinforced plastics).

Powerful drive and vibration-free running thanks to balanced DC motor. Housing of glass-fibre reinforced POLYAMIDE. Aluminium table tilting downwards through 50°, 10° upwards, with angle stop. Plane-turned sanding disc of die-cast aluminium covered with silicone film. This allows for effortless removal of sanding discs after use. Two additional square silicone films offer easy storage after use and thus re-use when needed. Machine can be secured both horizontally (with table) on the workbench, and also quickly and safely in vertical position. Suction connection and adapter to connect a vacuum cleaner for dust-free working. With each 2 sanding discs grit 80, grit 150 and grit 240.

Technical data:

230V. 140W. 50/60Hz. Adjustable grinding speed of approx. 250 – 800m/min (corresponds to 1,150 – 3,600rpm). Sanding disc Ø 125mm. Table 98 x 140mm. Sanding height 62.5mm. Size 300 x 140 x 160mm. Weight approx. 3kg.

NO 27 060

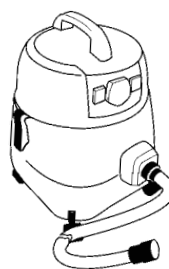

Both machines are equipped with suction connection and adapter for dust-free, clean sanding. We recommend our Compact Workshop vacuum cleaner CW-matic (see page 15) with integrated automatic switch control. The vacuum cleaner runs as long as the machine runs. There is a follow-up time of 5 seconds after switching off the power tool.

Self-adhesive white corundum sanding discs for TG 125/E

Industrial quality. For sanding soft and hard woods, chipboards, fibre boards, non-ferrous metals, steel, plastics, cork, rubber and minerals. Ø 125mm. One quadratic silicone film for storage and reuse of used sanding discs is included.

NO 28 160	80 grit	5 pieces
NO 28 162	150 grit	5 pieces
NO 28 164	240 grit	5 pieces



With 250mm-sanding disc and adjustable grinding speeds from 250 and 750m/min. Made in Europe.

Disc sander TSG 250/E

Sands long edges, end sections, radii, mitres, and, by turning the workpiece over - accurate flat surfaces at right angles.

Used on soft and hard woods, non-ferrous metals, steel, plastics (perspex and PC cards), cork and rubber. A simple chart indicates the recommended speeds on different materials.

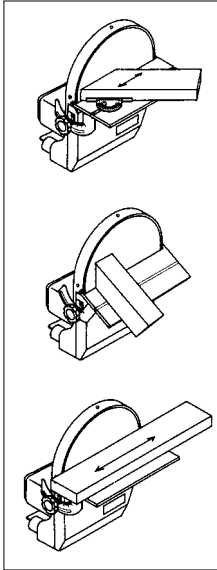

Sturdy construction:

Main body of ribbed die-cast aluminium (no steel tube or sheet metal construction). Turned flat grinding disc, provided with silicone film: This ensures that affixed sanding discs can be removed effortlessly after use. Two additional square silicone films for storage and reuse of used sanding discs are included. With dust collection adapter for connection to a vacuum cleaner for dust-free working. Complete with mitre gauge and 2 each sanding discs in grain 80 and 240.

Technical data:

230V with drive via Optibelt toothed belt (reduction ratio 7.3:1). Electronic speed control approx. 250 – 750m/min. Disc diameter 250mm. Maximum sanding height 135mm, table 275 x 105mm (tilts 15° in, 45° out). Overall size without table 330 x 280 x 230mm. Weight 7kg.

NO 28 060

Self-adhesive corundum sanding discs for TSG 250/E

Industrial quality. For sanding soft and hard woods, chipboards, fibre boards, non-ferrous metals, steel, plastic, cork, rubber and minerals. Ø 250mm. Includes silicone film for storing used sanding discs.

NO 28 970	80 grit	5 discs
NO 28 972	150 grit	5 discs
NO 28 974	240 grit	5 discs



250mm-sanding disc machined with diamond tools. Double ball bearing.



Self-adhesive silicone carbide sanding discs for TSG 250/E

For sanding non-ferrous metals, steel, glass, PC cards, plastics and ceramics. Ø 250mm. Includes silicone film for storing used sanding discs.

NO 28 976	320 grit	5 discs
------------------	----------	---------

Self-adhesive silicone film for easy sanding disc removal (Ø 250mm).

For retrofitting older disc sanders TG 250/E (production before 2007 with serial no. up to 14190). The film needs to be placed on the aluminium sanding disc and ensures easy removal of sandpaper discs after use. With 4 square silicone films for storage of used sanding discs and re-use when needed.

NO 28 968	set
------------------	-----



Perfect cuts in steel, non-ferrous metals, wood and plastic.
With triple ball bearing blade guide.

MICRO bandsaw MBS 240/E



Solid, ribbed die-cast aluminium housing (no tubular or sheet metal construction). Double ball bearing mounted aluminium pulleys.

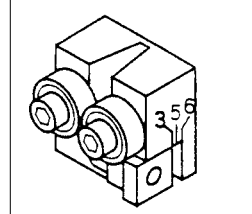

Sturdy, plane-milled table with slot for mitre gauge (tilts through 45° for accurate mitre sawing). Triple ball bearing blade guide system, adjustable in height and width for different widths of saw blades. Low noise 220V motor (high quality, for quiet, prolonged use) with Optibelt toothed belt.

Electronically controlled speed for exceptionally accurate cutting (no subsequent finishing necessary!).

A table indicates the recommended speed for practically all kinds of material. The blade size of 5 x 0.4mm is ideal for fine work and allows for cutting of small radii.

PROXXON		MBS 240/E													
Brennstoff						Blattgröße						Blattstärke			
Gas	Öl	Stahl	Alu	Werkst.	Werkst.	100	150	200	250	300	350	400	450	500	1
															2
															3
															4
															5
															6

Technical data:

230V. Blade speed adjustment from 180 to 330m/min (feedback effect). Throat 150mm, maximum height 80mm. Table 200 x 200mm (tiltable from 0° to 45°). Weight approx. 8kg. One blade 1,065 x 5 x 0.4mm (14 TPI) is included.

NO 27 172

Blade guide, separately (see figure above)

NO 28 187

Standard bandsaw blade

Of hardened Swedish steel. Fine-toothed (24 TPI). For steel and brass.

NO 28 174 1,065 x 5 x 0.4mm

As above, but coarse toothed (14 TPI)

NO 28 176 1,065 x 5 x 0.4mm

Narrow bandsaw blade (3.5mm)

From special tempered steel, with induction-hardened coarse teeth (14 TPI). Especially suited for cutting of small radii in wood, non-ferrous metal and plastics.

NO 28 180 1,065 x 3.5 x 0.5mm

Bandsaw blade of bimetal

Carrier belt of alloyed tempering steel, sawing teeth of wear-resistant high-speed steel. Varying teeth 10 – 14 TPI. Ideal for cutting all standard steel qualities, non-ferrous metals and stainless steel.

NO 28 172 1,065 x 6 x 0.6mm

Diamond blade

For cutting stone, ceramics, glass or glass-fibre reinforced plastics. Only proper cooling will ensure optimally cut glass or ceramics and enable a long service life of the band. Sparingly coolant liquid can be applied with a brush

NO 28 186 1,065 x 3 x 0.3mm

Scroll saw band, extra narrow (1.3mm)

Made of tempered special steel for extremely tight radii (10 teeth). For all types of wood, plastics and non-ferrous metals.

NO 28 182 1,065 x 1.3 x 0.44mm

NEW

Note:

TPI stands for the number of teeth per inch (25mm) per bandsaw blade.



Cut off/mitre saw KGS 80

Note:

You will find the smaller version of the KGS 80, our mini cut-off saw KG 50 (weighs only 1.5kg instead of 6kg) on page 38. Optional saw blades for the KGS 80 are offered on page 43.

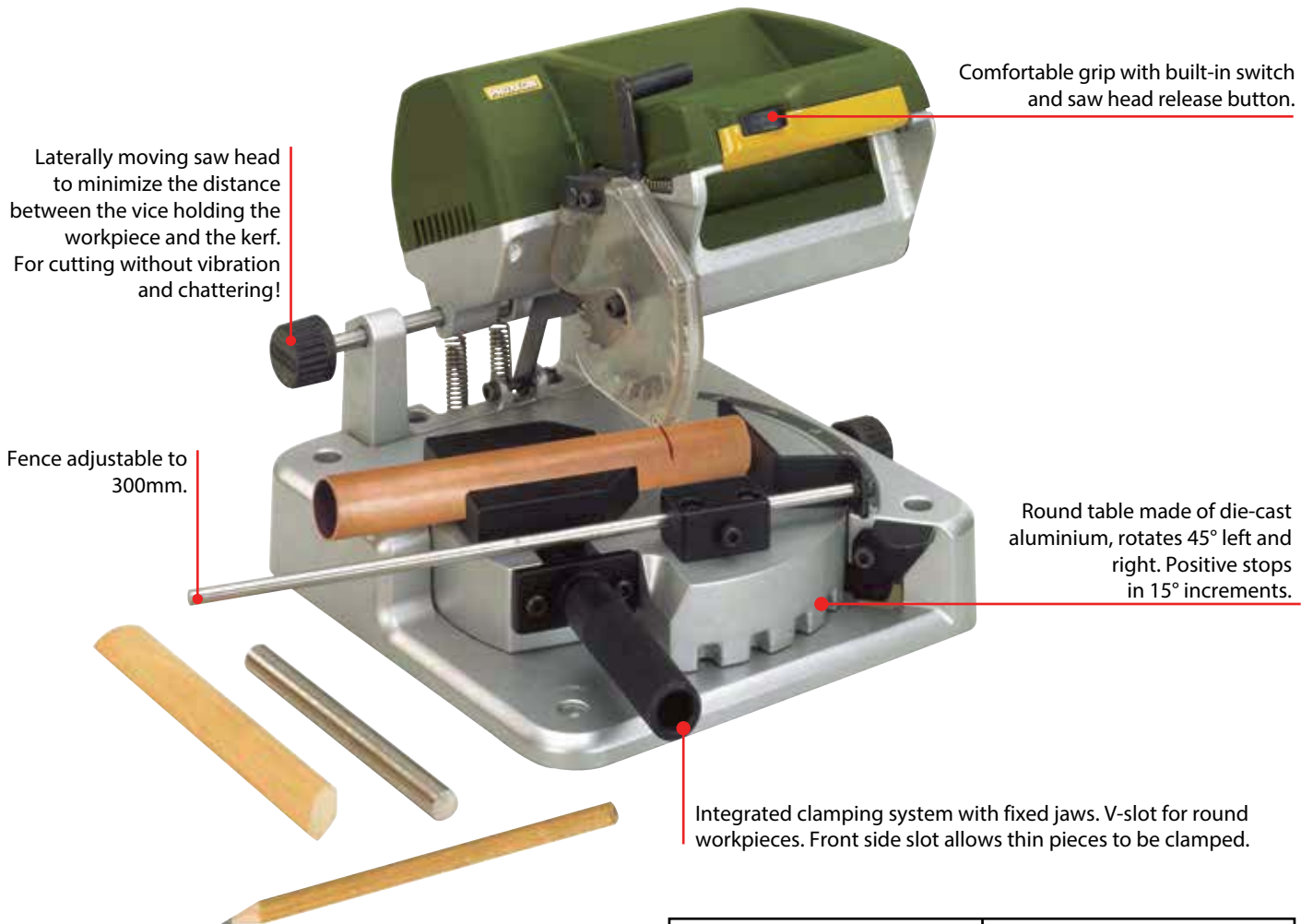

Comfortable grip with built-in switch and saw head release button.

Laterally moving saw head to minimize the distance between the vice holding the workpiece and the kerf. For cutting without vibration and chattering!

Fence adjustable to 300mm.

Round table made of die-cast aluminium, rotates 45° left and right. Positive stops in 15° increments.

Integrated clamping system with fixed jaws. V-slot for round workpieces. Front side slot allows thin pieces to be clamped.

Ideal for mitre cuts: Adjustments are made to the round table (with clamped work piece) and not to the head stock!

The opposite angle for a second frame part of identical length occurs through simple shifting with the longitudinal stop and by rotating the table by 2 x 45°. Powerful, quiet DC-motor. Smooth toothed belt drive ensures power transmission. Tungsten-tipped saw blade for non-ferrous metal, wood and plastics (80 x 1.6 x 10mm, 36 TPI).

Other technical data:

230V. 200W. 50/60Hz. 6,000rpm. Base with round table of highly stable die-cast aluminium with CNC-milled fittings and slides. Table 230 x 230mm. Weight 6kg. See table for cutting capacity.

Cutting capacity at 90° (right angle cut)			Cutting capacity at 45° (mitre cut)		
Material size (in mm)	Max. material width (in mm)	Round material (in mm)	Material size (in mm)	Max. material width (in mm)	Round material (in mm)
10	65		5	36	
18	50		10	30	
21	40		15	25	
25	25	Ø max. 25	20	18	Ø max. 20

Cutting disc, with reinforcement.



Corundum-bound and shatter-proof. For cutting alloyed and non-alloyed steel, stainless steel and non-ferrous metals. Also suitable for wood and plastics.

NO 28 729 80 x 1 x 10mm

Tungsten tipped circular saw blade (36 T).



Extremely clean cut edges thanks to high tooth count when cutting balsa, plywood, soft wood and glass reinforced plastic boards. Also for cutting hard wood, POLYCARBONATE, plastics and aluminium.

NO 28 732 80 x 1.6 x 10mm

Bench drill machine TBM 220

The optional MICRO compound table
KT 70 is described on page 23.



3 spindle speeds by shifting the flat belt for more than the triple torque in the lower rotational speed range.

Fully adjustable depth gauge.

Machine vice MS 4 made of die-cast zinc is an invaluable accessory and is described in detail on page 22.



6 MICROMOT steel collets are included in the scope of delivery.

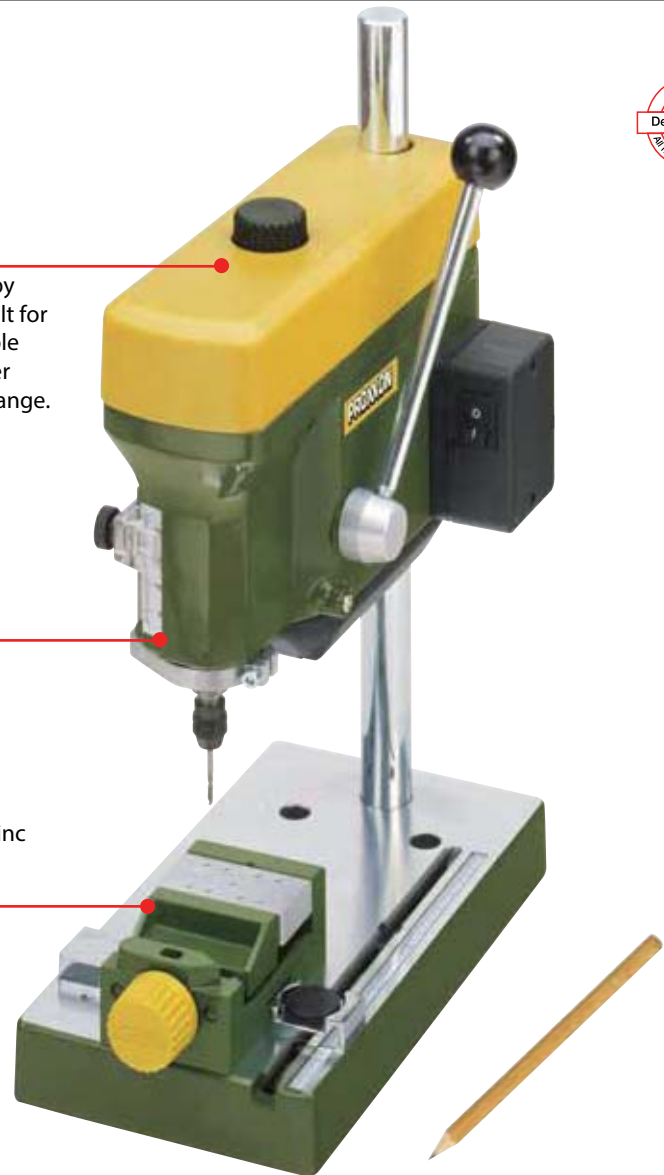

Plane-milled worktable of die-cast aluminium (220 x 120mm) with adjustable fence and scale as well as threaded holes for securing the MICRO compound table KT 70.

Solid steel column (20 x 340mm). Adjustable fence with scale. Solid, hard-chromed steel column, 340mm high, 20mm diameter. Super stable die-cast head with VDE approved motor. Very quiet and of long life expectancy type. Power transmission by aluminium pulleys and flat belt. Three spindle speeds (triple torque at low speeds). Feed lever with adjustable depth scale.

Technical data:

230V. 85W. 50 – 60Hz. Spindle speeds of 1,800, 4,700 and 8,500rpm. Extremely high rotational accuracy, 30mm feed. Throat depth (column to drill spindle) 140mm. Six triple slit precision collets for shaft sizes 1 – 1.5 – 2 – 2.4 – 3 – 3.2mm are included. 3/8" thread. Weight 3.3kg.

NO 28 128

Chuck

For drill shank sizes 0.5 to 6.5mm. Max. speed 10,000rpm. Industrial quality with extra high speed accuracy.

With 3/8" thread for MICROMOT bench drill TBM 220.

NO 28 122



Precision machine vices Ease of operation. With precise jaw guide:





A machine-one of a kind. Made in Europe. Ideal for precision mechanics, workshop and lab.

Bench drill press TBH

Ideal for jig boring with the compound table KT 150 (page 68).



Note:

Table and arm of the table drilling machine offered here are made of die-cast aluminium. A refined, rust-proof and statically very solid material. Fittings and feeds are machined on our highly modern CNC-controlled machines (milled, line-bored, lathed, etc.).

Practical height adjustment via toothed rack with easy to operate crank.

Powerful, long-lasting direct current motor. Spindle drive via triple belt pulley with the advantage of roughly 6 times the torque in the lower rotational speed range. Practical drill depth indicator with adjustable limit stop. Drill spindle with precision bearing. Spindle head with 1/2" thread for the corresponding chuck (industrial quality). Spindle with additional fit for steel collets NO 28 200.

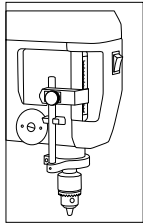

Technical data:

230 Volt. Spindle rotational speeds 1,080 – 2,400 and 4,500rpm. Sliding sleeve stroke 63mm. Height adjustment via crank 70mm. Throat 140mm. Usable table surface 200 x 200mm. Column 45 x 500mm. Tool holder up to 10mm. Drilling performance in steel 10mm. Weight approx. 10kg.

NO 28 124

PRIMUS 75

Base body made of special cast iron with CNC-machined guides. Interchangeable gripping jaws. Flat-milled working surface. Spindles with rolled trapezoid thread for ease of operation even during high axial load. Width of jaws 75mm. Jaw opening 65mm. Distance from long slot centre to long slot centre 100mm. Long slots 80 x 11mm. Weight 2.5kg.

NO 20 392

PRIMUS 100

Width of jaws 100mm. Jaw opening 75mm. Distance from long slot centre to long slot centre 135mm. Long slots 105 x 15mm. Weight 5kg. Other details as for the PRIMUS 75.

NO 20 402

T-nut set for PRIMUS vices

2 T-nuts, screws and the necessary accessories. For fixing to the drill tables of: BFB 2000, KT 150 and bench drill press TBH.

NO 20 394



Practical height adjustment via toothed rack with side crank.

Stable, strongly ribbed plane-milled worktable with two T-slots.

Collet set for Bench drill press TBH

Triple slit and hardened. 1 each of 2.35 – 3 – 3.2 – 4 – 5 and 6mm. With collet closure nut (M 17).

Neatly packed in wooden box with sliding lid.

NO 28 200

Drilling device BV 2000



An accurate device for parallel drilling, thread-cutting and milling. Made of high-precision aluminium die-casting.

With two-way pivotable articulated arm and 20mm standard collar. Once the device is clamped, it always remains vertically aligned. This means that, e.g. drill holes are always exactly perpendicular to the work piece surface! Preselectable drill depth using depth control with easy-to-read scale. After drilling, an adjustable spring automatically pulls the device back into its top rest position.

Plane-milled solid base plate with 200 x 200mm usable table area and two continuous MICROMOT standard T-slots (12 x 6 x 5mm). Stable drill column (Ø 45mm, 500mm long).

The standard 20mm collar enables precise clamping of the drilling device such as the precision drill/grinder FBS 240/E, professional drill/grinder IBS/E, long neck straight drill/grinder LBS/E, MICROMOT 60, 60/E, 60/EF and MICROMOT 230/E.

NO 20 002

Adapter for use of the MICRO screwdriver MIS 1 with BV 2000 for cutting threads



Due to the practical rocker switch for on/off/reverse and a rotational speed of 250rpm the MIS 1 is ideal for cutting threads: The thread cutter is precisely guided and ensures very precise and exact vertical female threads.

NO 20 004

Note:

Professional drill/grinder IBS/E, MIS 1 and step clamps are not included in the scope of delivery.

MICRO-Press MP 120

A precision tool for precision mechanics and model making: Pressing in, pressing out, riveting, imprinting, edging, bending of wires and sheets. Embossing, beading and crimping of easy to form materials.

With 5 cylindrical pressing tools (surface hardened) being inserted into the toothed rack and fixed with a knurled screw: Ø 3 – 4 – 5 – 6 and 8mm. One each semi-spherical profile Ø 3 and Ø 9mm and a 60° square prism for bending sheet metal. The counterpart is an easily adjustable, hardened revolving plate with all required holes and bottom dies for the above-specified pressing tools. Toothed rack at one front end with 6mm bore for use of the 8 bottom dies for the above-specified pressing tools. 5mm bore at the other front end for use of all commercially available riveting tools: simply wind up the toothed rack, take it out and reinsert it upside down.



Force of pressure approx. 1,000N (100kg). Maximum stroke of toothed rack with inserted tool 65mm, above revolving plate 50mm. Solid steel arm with 120mm throat. Ground base plate of steel, 80 x 190mm with an 8mm centre and two fastening bores. Weight approx. 2,800g.



NO 27 200

Engraving device GE 20

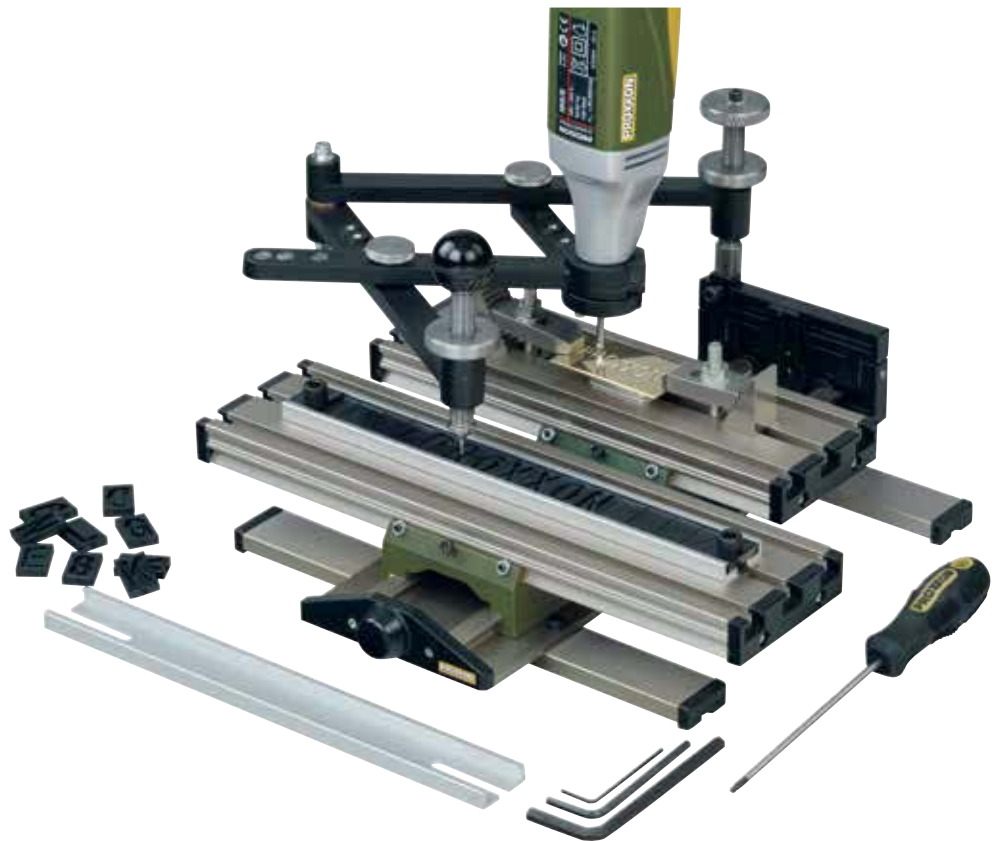

Note:

Professional drill/grinder IBS/E and clamping jaws are not included in the scope of delivery.

With standard 20mm collar for all MICROMOT drilling and milling units which are equipped with steel collets.

For engraving letters, numbers and individual shapes on metal, plastics, glass or stoneware. For name plates, jewellery or valuable materials. Also easy to manufacture miniature, individual shapes, engravings, cut-outs and outline shapes, even in series, using self-made templates or commercially available templates (plants, animals, coats of arms).

Guide bar (template holder) holds a maximum of 14 letters. Template contours are precisely to be followed using the guide marker (ball handle).

The lettering to be milled is scaled down during transfer. The transfer ratio can be fixed at 2:1, 3:1, 4:1 or 5:1 by simply adjusting two screws. The work piece is aligned and fixed on the movable guide block with clamping jaws (here MICROMOT clamping jaw set NO 24 256) or a vice.

Scope of delivery: two sets of letters from A to Z, incl. hyphen, full stop and slash (total 78 items), one each HX key 1.5 – 3 and 5mm as well as a HX (ball head) screwdriver 2.5mm. Complete with a comprehensive instruction manual.

NO 27 106

Stencil set for engraving device GE 20

Letters A – Z, incl. hyphen, full stop and slash. Also numbers 0 – 9. For use with guide bar of the GE 20.

NO 27 104

Solid carbide stylus for engraving device GE 20

For steel, cast steel, non-ferrous metal, plastic, glass, stoneware and tiles. Nose angle 60° (for V-shaped letters). Shaft diameter 3.2mm.



NO 28 765

Letter width 0.5mm

NO 28 766

Letter width 1mm

Manual for creative model-makers

Over 370 pages of information and tips from all areas of model building. All illustrations in colour.

Attractively produced, this book affords a good insight into the areas of materials and their application possibilities. It describes tools and work techniques in general and gives comprehensive technical explanations concerning MICROMOT devices and available accessories.

A large portion is devoted to practical tips and a clear appendix of useful tables completes the contents of this helpful manual.

Available in German only !

NO 28 996



MICRO miller MF 70/CNC-ready



With step motors for axes X (transverse), Y (lengthwise) and Z (high) instead of handwheels.

Interesting for users who already own a control unit or would like to purchase one from another provider on the market. Step motors and reference point switch with 2.2m connecting cable and one each standard plug (SUB-D 9-pole) for X, Y and Z axis. Without CNC control unit, without CNC software.

Other technical design similar to MICRO miller MF 70 offered at right.

Exception: Larger T-slot table and somewhat longer travel distances X (transverse) and Y (lengthwise). Including MICROMOT collets (steel, hardened, triple slit), with 1 each of 1 – 1.5 – 2 – 2.4 – 3 and 3.2mm. The illustrated stepped steel clamping jaws are also included in the delivery.

Technical data:

230V. 100W. 50/60Hz. Spindle speeds 5,000 – 20,000rpm. Table 250 x 70mm. Travel distances: X (transverse) 150mm, Y (lengthwise) 70mm, Z (high) 70mm. Resolution of step motors 0.005mm. Total height 370mm. Weight approx. 7kg.

NO 27 112

MICRO compound table KT 70/CNC-ready



Of solid aluminium (surface-compacted), as described at right. With two step motors for the axes X (transverse) and Y (lengthwise). Table size and travel distances, see description of MF 70/CNC-ready.

NO 27 114

Dividing head for MICRO miller MF 70 and MICRO compound table KT 70

For machining circular work pieces, manufacturing off-set holes and milled out portions, milling key surfaces, four-sided, six-sided materials, etc. Absolute accurate division due to nonius at the base body. With reversed chuck jaws: Capacity inside 1.5 to 32mm, outside 12 to 65mm. Bore of 11mm (for processing longer spindles in a vertical position). With fastening bores for horizontal and vertical mounting and suitable slot nuts and fastening screws for mounting to the MICRO miller MF 70 and the MICRO compound table KT 70. Size 72 x 64 x 38mm. In wooden box with sliding lid.



NO 24 264

Precision steel vice PM 40

Milled from steel for precision. Completely angular.

Jaw width 46mm, clamping capacity 34mm. Total length 70mm. Especially suited for filigree and accurate working with the MICRO miller MF 70 or the compound table KT 70. Sliding blocks and fixing screws included. Comes in a wooden box.

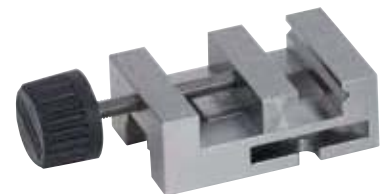

NO 24 260



Small but excellent: the accurate milling machine for lab technicians, opticians, jewellers, electricians/model builders. Made in Europe.

MICRO miller MF 70

**The accurate miller for delicate projects.
Spindle speeds 5,000 - 20,000rpm.**



Continuously variable speed from 5,000 – 20,000rpm, perfect for even the smallest milling cutter.

Cutter clamping in MICROMOT system collets.

Supplied complete with stepped clamp blocks of steel. These are shown on page 23 (offered separately).

Table of stable aluminium. Both axes are fitted with adjustable dovetail slides.

Stable cast iron base.

MICROMOT steel collets, triple slit and hardened, from 1 to 3.2mm.

Handwheels with zero adjustable scales, 1 revolution = 1mm, 1 division = 0.05mm.

For work with extremely small cutters.

Stable grey-cast iron machine base, vertical guide and compound table. Free from play, readjustable dovetail gib in all axes. Die-cast aluminium arm housing, with 24-pin special motor (balanced). For vibration-free work at high speeds. The triple slit, hardened steel MICROMOT collets cover 1 – 1.5 – 2 – 2.35 – 3 – 3.2mm. The table is fitted with 3 T-slots of the 12 x 6 x 5mm MICROMOT norm. An adjustable ruler scale eases the positioning of the workpiece.

Technical data:

230V, 100W, 50/60Hz. Spindle speeds 5,000 – 20,000rpm. Table 200 x 70mm with X-Y travel of 134 and 46mm respectively, with vertical travel 80mm. Footprint size 130 x 225mm and overall height 370mm. Weight approx. 7kg. The clamping blocks depicted are included too, but not the workpiece !

NO 27 110

Tungsten milling cutters

With two flute cutters and fishtail profile (cutting to the centre). Enables lowering into non-bored work pieces. For grey-cast iron, hardened cast iron, steel, cast steel, brass, aluminium, glass, plastic and carbon fibre. One piece each 1 – 2 and 3mm. Shaft diameter 3mm. Can also be ordered separately (see page 25).



NO 27 116

3 pieces



Light, stable and precise. 2-stage belt drive and additional electronic up to 5,000rpm. The right cutting speed for even the smallest pieces.

Precision lathe FD 150/E

For face turning, longitudinal turning, boring, taper turning, slicing and drilling. Complete with 3-jaw chuck and live centre.



Centre distance 150mm. Swing 55mm. Height over cross slide 33mm.

Machine bed with dovetail guides of continuous casting aluminium.

Die-cast aluminium **spindle headstock**. With quiet special DC motor, 2-stage belt drive and additional electronic speed control for high engine power at low speeds for larger work pieces and for the appropriate cutting speed, even for the smallest pieces. Main switch with emergency stop function and restart protection. Precision bearing mounted main spindle with continuous 8.5mm bore. Chuck fit for standard ER 11 type collets.

Three-jaw chuck, self-centering (inside jaws 1 – 20mm), outside jaws 20 – 50mm).

Die-cast aluminium **tailstock** with spindle and live centre (fitting MK 0/ short).

Support: To be shifted manually on the bed and clamped with lever. Rotating tool post for turning steels 6 x 6mm.

Processing via top slide (60mm, travel distance Z) and cross slide (40mm, travel distance X). The angle adjustment of the upper carriage makes it possible to turn tapers up to +/- 45°.

Handwheels with zero adjustable scale ring (1 division = 0.05mm, 1 revolution = 1mm).

Other technical data:

230V. 50/60Hz. Distance between centres 150mm. Swing 55mm. Height over cross slide 33mm. Cross slide travel (X) 40mm, top slide travel (Z) 60mm. Steel tool post for turning steels 6 x 6mm. Spindle bore 8.5mm. 2-stage belt drive with electronic speed control: Stage 1 = 800 – 2,800rpm. Stage 2 = 1,500 – 5,000rpm. Dimensions approx. 360 x 150 x 150mm. Weight 4.5kg. Insulated to class 1.

NO 24 150

speed control enable spindle speeds
Made in Europe.

6-piece turning tool set. Made of high-quality cobalt HSS steel. Ground.



One each boring, roughing out, parting, finishing, right and left cutter. Size 6 x 6 x 65mm. For FD 150/E, supplied in wooden box.

NO 24 524 6 pieces

Drill chuck. Capacity 0.5 – 6.5mm.



Industrial quality with high concentricity (allowed up to 10,000rpm). Complete with arbour B 10 x MK 0/short. For the tailstock of the FD 150/E.

NO 24 152

Multiple range standard ER 11 type collets (DIN ISO 15488)



Offering high concentricity. May be reduced up to 0.5mm below their nominal diameter (intermediate sizes not required). D = 11.5mm, L = 18mm. One each of 2 – 2.5 – 3 – 4 – 5 – 6 and 7mm are included. With clamping nut M 16 x 1. Suitable for the main spindle of the FD 150/E. Supplied in a wooden box.

NO 24 154 7 pieces

Chip collecting tray with splash guard for the FD 150/E

Of 1.5mm thick sheet steel, powder-coated. Bevelled edges at the front and back enable easy cleaning. Pre-drilled mounting holes for the secure stability of the FD 150/E. L 400 x W 165 x H 140mm. The lathe depicted here is not included in the scope of delivery.

NO 24 156



Drill sharpener BSG 220

Easy sharpening of drill bits from 3 to 13mm diameter, standard angle of 118°.



Note:

Operating the Drill sharpener BSG 220 is quite simple. Also untrained users will be able to re-sharpen spiral drills according to DIN. In order to obtain satisfactory results though, it is important to study the product manual attentively before working with this machine. Starting without reading these relevant instructions, one will not be able to achieve the expected precision.

The sharpening operation is controlled exactly by means of the movable carriage.

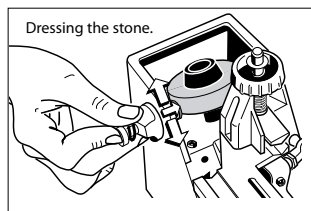

This moves from left to right and also rotates the drill bit on its own axis. This operation yields the correct relief angle. The carriage is fitted with a feed screw for fine feed. A dressing stone, ensuring a sharp cutting surface, is also fitted.

Other technical data:

230V, 85W. Corundum grinding disc size 50 x 13mm. ABS housing with fixing holes. Weight 1.7kg. An easy to understand operating manual and replacement disc accompany the unit. For further spare discs see page 38.

NO 21 200

Adapters for sharpening of small drill bits

These adapters extend the BSG 220's range to cover 1.5 – 3mm. One each adapter for sizes 1.5 – 1.6 – 2 – 2.4 – 2.5 and 3mm. Neatly packed in a wooden box with sliding lid.



NO 21 232

For face, longitudinal and taper turning, thread-cutting. For machining steel, brass, aluminium. Mounting flange for fastening the mill/drill head PF 230.



Centre distance 250mm. Swing 70mm. Height over cross slide 43mm.

Machine bed: Of cast iron, wide-legged prismatic guide. For vibration-free work even at high loads. Rear flange for mounting the mill/drill head PF 230. Covered lead spindle.

Headstock: Of die-cast aluminium. Precision bearing mounted main spindle (run-out without chuck 1/100mm) with 10.5mm opening. Chuck side 70mm hollowed to 14mm. With MK 2 bore. Rotary switch for engaging the automatic feed via lead and feed spindle (optionally 0.05 or 0.1mm/rev.).

Tailstock: Of die-cast aluminium. Sleeve \varnothing 18mm, retractable up to 30mm. With millimetre scale, MK 1 bore and live centre.

Support: Bed carriage made of die-cast zinc. Cross slide and top slide of steel (adjustment 60 or 45mm). Turning tool post for cutting tools size 8 x 8mm.

Drive: Quiet DC special motor with 3-stage belt drive for 300 – 900 and 3,000rpm. With additional speed control (full-wave electronics) continuously adjustable to 100 – 300 or 1,000rpm, depending on belt

ratio. Clockwise - anticlockwise rotation. Main switch with emergency stop function and restart protection.

Lathe chuck: High quality 3-jaw chuck as per DIN 6386 Class 1 (concentricity tolerance 0.04mm). Capacity 3 – 100mm (each one set of interior and exterior step-jaws). Including lathe chuck guard with safety shutdown.

Handwheels: Of aluminium, with adjustable scale ring (1 division = 0.05mm, 1 revolution = 1mm).

Thread cutting device: With change gears for left-hand and right-hand threads of the most important metric pitches (0.5 – 0.625 – 0.7 – 0.75 – 0.8 – 1 – 1.25 – 1.5mm).

Other technical data:

230V. 50/60Hz. Size L 560, W 270, H 170mm. Weight approx. 12kg.

NO 24 002

um and plastic.



Note:
The work piece pictured here
is not included in the delivery!

Collet set with ER 20 collets: For extreme true concentric accuracy. 2 – 10mm. (DIN ISO 15488).



For high precision machining of round parts. The collet set is mounted instead of the lathe chuck. With 8 collets (2 – 2.5 – 3 – 4 – 5 – 6 – 8 and 10mm). Packed in a wooden box.

NO 24 038

4-jaw chuck with independent jaws

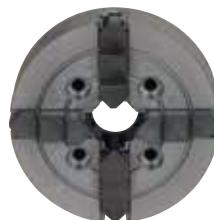

For clamping angular and asymmetrically shaped work pieces. Capacity up to 80mm. Chuck Ø 75mm.

NO 24 036

Centre turning attachment. For highest accuracy with high rotational precision.

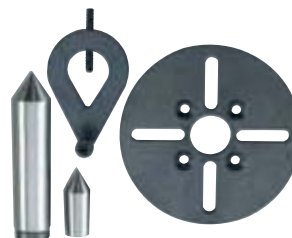

This includes:
1 face plate, 2 fixed centres (MK 2 and MK 1/short) and 1 drive dog. Packed in a wooden box.

NO 24 014

Professional gear chuck with MK 1



For the tailstock of the PD 250/E. Capacity up to 10mm.

NO 24 020

Quick change tool post – easy to use!

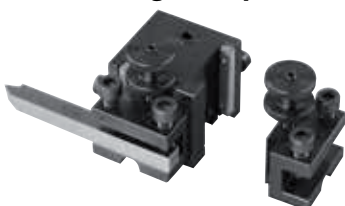

For quick tool change and easy height adjustment. Includes 2 tool holder elements.

NO 24 026

Additional quick change tool holder (separately)

Can be used with the above above-mentioned quick change tool post.

NO 24 024 piece

Fixed steady for longer work pieces



Especially for boring. Also required if the tailstock cannot be used to „counter“. Up to Ø 40mm.

NO 24 010

Chip collecting tray with splash guard for lathe PD 250/E

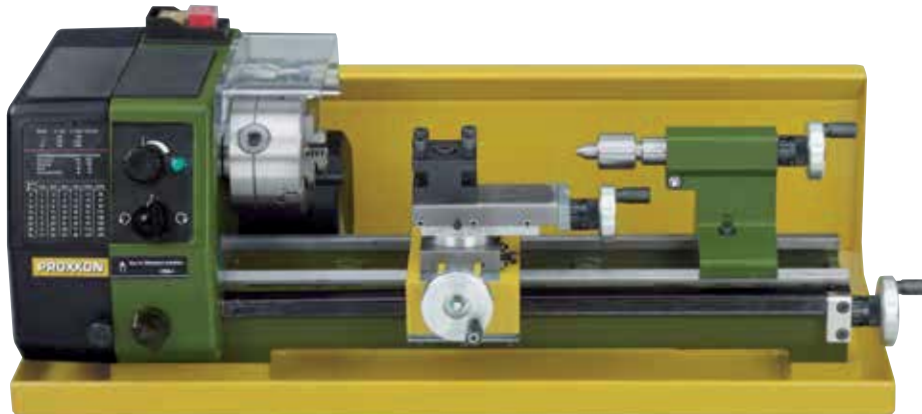

Made from 1.5mm thick sheet metal, powder coated. Bevelled edges at the front and back allow slight clean-ing. Mounting hole and raised base to secure lathe are pre-drilled. The depicted lathe is not included in the offer.

L 550 x W 230 x H 175mm
NO 24 008 for PD 250/E



Dividing attachment TA 250
For lathe PD 250/E, miller PF 230 and FF 230

For accurate machining of circular work pieces (e.g. production of gear wheels). Supplied with two dividing discs (40 and 48 teeth), enabling standard divisions of 2 – 3 – 4 – 5 – 6 – 8 – 10 – 12 – 16 – 20 – 24 – 40 und 48. The taper of the dividing attachment is the same size as that of the main spindle of the PD 250/E lathe, thus 3 jaw chuck (to be ordered separately under NO 24 034, see below) and 4 jaw chuck (NO 24 036, see page 57) may be mounted. Horizontal fitting (e.g. on the cross-slide of the lathe) and vertical fitting (on the machine bed) are possible. With matching nuts and screws for fixation in MICROMOT standard T-slots (12 x 6 x 5mm). Supplied in a wooden box with sliding lid. The 3 jaw chuck depicted here is not included in the scope of delivery.

NO 24 044

Self-centering 3-jaw chuck

Identical to chuck of lathe PD 250/E (page 56). High quality clamping fixture as per DIN 8386, Class 1 (concentricity accuracy 0.04mm). Capacity through reversing jaws from 2 – 75mm. Suitable for PD 250/E and the dividing attachment NO 24 044.

NO 24 034

Mill and drill head PF 230
Converts your lathe PD 250/E or PD 400 into a complete machining centre.

Includes column (35 x 400mm), mounting bracket and fastening screws (the PD 250/E and PD 400 already come with a plane-milled surface).

The lathe's top slide is replaced with the table (supplied) of 110 x 70mm, with 3 T-slots 12 x 6 x 5mm. The lathe now functions as a compound table, with X-Y travel being longitudinally and cross-wise respectively. The mill/drill head is identical to the miller FF 230 (see page 59). Three collets of sizes 6 – 8 and 10mm are included.

NO 24 104





A small, high accuracy machining system to mill, drill and bore. Made in Germany.

Miller FF 230

The headstock swivels through 360°, indicated on a scale.

Height is adjusted via a zero adjustable handwheel, also used as fine feed when milling (one revolution equals 1mm travel). The quill and headstock may be locked in position, essential when milling. The powerful motor effects drive via a poly-V belt, yielding high torques, especially at lower speeds. Collets of 6 – 8 and 10mm are included. The solid table is T-slotted to the MICROMOT standard of 12 x 6 x 5mm.

Other technical data:

230V. 140W. 50/60Hz. Spindle speeds of 280 – 550 – 870 – 1,200 – 1,500 and 2,200rpm. Throat 65mm. 30mm travel. Table size 270 x 80mm, column 35 x 400mm long. X-Y- travel is 170 x 65mm. Maximum height 180mm and depth 130mm. Overall height approx. 500mm. Weight approx. 17kg.

NO 24 108

The clamps (not included) are described on page 66.

Note:

For more lathe and milling accessories and bits and cutters, see pages 66 /67.

Important!

For clean milling we recommend to clamp the quill as well as the headstock onto the column. With the FF 230 this is easily done with the clamp.

Compound table KT 230

As described above, but excluding headstock and column. With 34mm bore to mount the PF 230 mill/drill head (the end fitting of the mill head's 35mm column is machined to 34mm).

NO 24 106

Five piece collet set for PF 230 and FF 230

Includes 1 each of 2.4 – 3 – 3.2 – 4 and 5mm, for milling cutters. Supplied in a wooden box with sliding lid.

NO 24 144

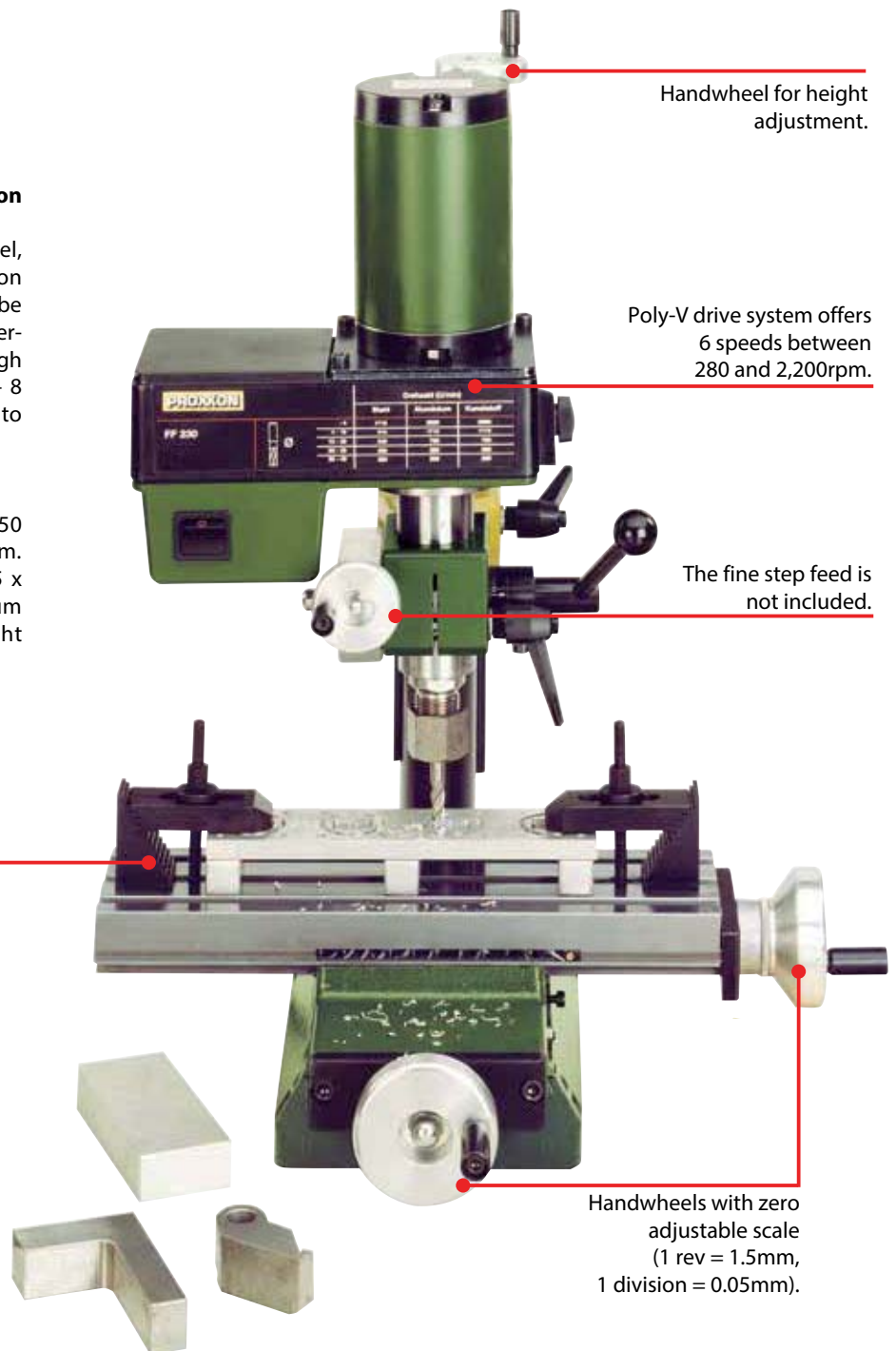

Handwheel for height adjustment.

Poly-V drive system offers 6 speeds between 280 and 2,200rpm.

The fine step feed is not included.

Handwheels with zero adjustable scale (1 rev = 1.5mm, 1 division = 0.05mm).

Fine feed for milling machine PF 230 and miller FF 230

Easily installed in a few seconds.

The feed may be used via either the height feed (vertical) or the fine feed in the tilted position.

The graduated scale may be zero reset. One revolution is equivalent to 1.5mm spindle travel (1 division = 0.05mm).



NO 24 140

Precision lathe PD 400



Note:

Accessories and insertion tools for the PD 400 system, see pages 61/62.

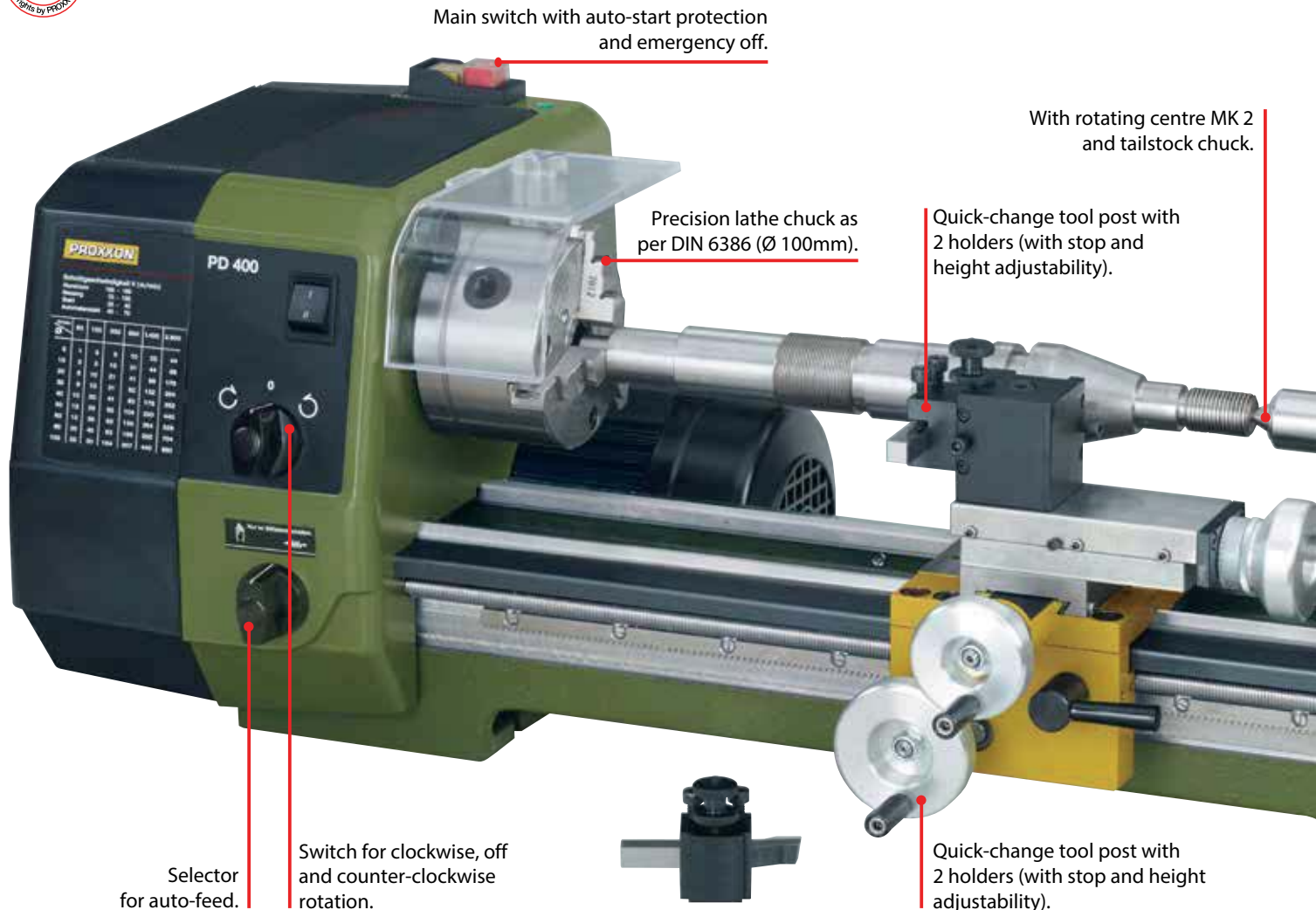

Centre distance 400mm. Swing 85mm. Height over cross slide 58mm.

For machining steel, brass, aluminium and plastic. For face and straight turning, taper turning and thread cutting. With an extensive range of system accessories you can also drill, mill and slot.

Machine bed: Of high quality cross-braced cast iron with wide-legged, prism slides. For vibration-free work even at high loads. With flange and threaded holes at back for fastening the drill and mill head PF 230. Covered lead spindle.

Headstock: Of die-cast aluminium. Oversized main spindle with two adjustable taper roller bearings and MK 3 bore on chuck side. Spindle bore 20.5mm. Run-out without chuck 1/100mm. Rotary switch for engaging the automatic feed (optionally 0.07 and 0.14mm/rev.). Lead and feed spindle with trapezoid threading (12 x 1.5mm).

Tailstock: Of die-cast aluminium. Sleeve Ø 24mm, retractable up to 40mm. With mm scale. With live centre MK 2 and 10mm gear tooth

chuck (B 12 - bore/MK 2).

Support: Bed carriage made of die-cast zinc. Cross slide (adjustment 85mm) and top slide (setting range 52mm) of steel. Top slide can be swivelled for taper turning (degree graduation up to 45° available). With multiple tool posts and two tool post elements for quick change and easy height adjustment. For turning tools 10 x 10mm.

Drive: Powerful capacitor motor for two speeds and additional three-stage belt drive. Spindle speeds at stage 1: 80 – 330 – 1,400rpm. For stage 2: 160 – 660 and 2,800rpm.

Lathe chuck: High quality 3-jaw chuck as per DIN 6386 Class 1 (concentricity tolerance 0.04mm). Capacity 3 – 100mm (each one set of interior and exterior step-jaws). Including lathe chuck guard with safety shutdown.

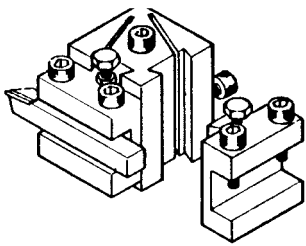

A tool holder with two adjustable inserts is included as standard.

Tool post

Including two holders. Provides quick tool changes with easy height adjustment. For turning tools 10 x 10mm.

NO 24 415

Individual quick-change holder

Fits the tool post of PD 400.

NO 24 416

Aluminium handwheels with adjustable graduated collar made from steel.

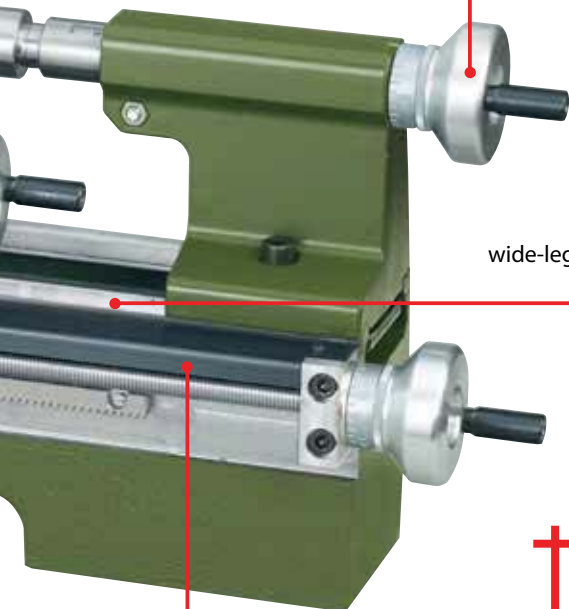

Cross-braced cast iron bed, wide-legged shape, and prism slides for apron and tailstock.

Protected lead screw with 12 x 1.5 Acme thread.

Note:

The lathe PD 400 is also available as CNC version. See page 65.



4 jaw chuck with independent jaws

Used to mount irregularly and asymmetrically shaped objects. Each jaw is adjusted individually and centering is thus achieved manually. Hardened, reversible jaws. Chuck diameter 100mm.

NO 24 410



4 jaw chuck, self-centering

The jaws are not independently adjustable, i.e. they are self-centering. High accuracy. Chuck diameter 100mm.

NO 24 408

Self-centering 3-jaw chuck

The jaws are not independently adjustable, i.e. they are self-centering. Capacity 3 – 100mm (each one set of interior and exterior step-jaws). Identical to the lathe chuck of lathe PD 400.

NO 24 407



Faceplate and clamps

Ø 125 mm. Is fitted instead of the standard chuck. Ideal for clamping larger and asymmetrically shaped work pieces. 2 continuous T-slots. With clamping jaws.

NO 24 412

Handwheels: Of aluminium, with scale ring adjustable to 0. For cross slide and top slide: 1 division = 0.025mm. 1 rev. = 1mm. For tailstock and lead spindle: 1 graduation line = 0.05mm. 1 rev. = 1.5mm.

Support quick adjustment: By means of large handwheel fastened to bed by toothed rack.

Thread cutting device: For left-hand and right-hand thread. With change gears for 19 different metric pitches: 0.2 – 0.25 – 0.3 – 0.35 – 0.4 – 0.45 – 0.5 – 0.6 – 0.7 – 0.75 – 0.8 – 0.9 – 1 – 1.25 – 1.5 – 1.75 – 2 – 2.5 – 3mm. Also for inch threads from 10 – 48TPI.

Other technical data:

230V. 50/60Hz. Size L 900, W 400, H 300mm. Weight approx. 45kg. Motor rated input 870W, power output 550W, motor speeds 1,400 / 2,800rpm.

NO 24 400

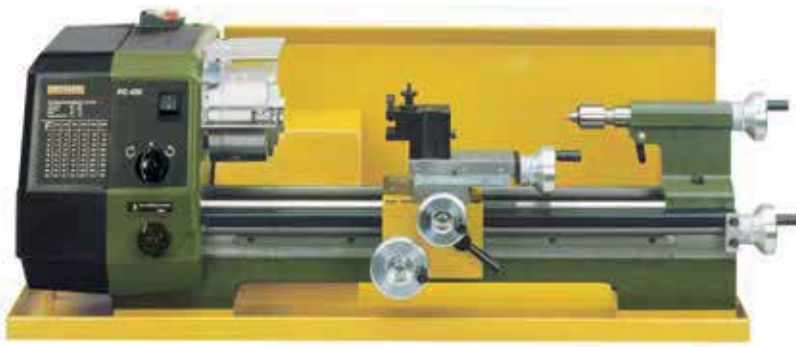

Splash guard and chip collecting tray for lathe PD 400

Made from 1.5mm steel plate, powder coated. A welded cover protects the motor. Mounting holes and raised base to secure the lathe are pre-drilled. Seeping through of coolant is impossible. Length 800 x width 270 x height 290mm.

NO 24 402



Collet attachment with collets for PD 400

For accurate use on round components. One hardened collet each hardened collet 2 – 3 – 4 – 5 – 6 – 8 – 10 – 12 and 14mm are included. Concentric accuracy better than 0.02mm, much better than a chuck. One soft collet for making a custom size yourself. The included collet attachment is mounted in the place of the headstock chuck. Supplied in a wooden box.

NO 24 419 complete

Mill/drill head PF 230 for lathe PD 400

This mill/drill head's construction is identical to our FF 230. For mounting on the PD 400. For technical details of the PF 230 please refer to the description on pages 58/59.

NO 24 104



Fixed steady to support longer pieces for PD 400

Used on the PD 400 when turning long, slender work pieces. Fitted directly to the bed-ways and is used when the tailstock support is inadequate. Maximum Ø 50mm.

NO 24 404



Travelling steady for PD 400

Fitted to the carriage of the lathe. Indispensable when turning long, slender work pieces. Maximum Ø 50mm.

NO 24 406



Centre turning accessory for PD 400

Ideal when turning with highest possible accuracy. Supplied with 2 dead centres (MK2 and MK3), drive/face plate with 30mm bore as well as reducing bushes 30/20mm and 30/15mm. A threaded drive pin screws into the headstock flange and the drive plate.

NO 24 414

Gear tooth chuck (10mm). With adapter for PF 230, FF 230, FF 500/BL.

Industrial quality, however not as accurate as the collets. With 10mm adapter which fits into the 10mm collet. Includes the chuck key.



NO 24 110

Miller FF 500/BL

With brushless direct drive. Made in Germany.



Variable speed pre-selection from 200 – 4,000rpm at high precision (accuracy 0.05mm). Digital speed indication.

The sophisticated control via rotor position and speed sensors guarantees high torque for use of large milling cutters in the lower speed range.

Solid column with dovetail guides. Milling head can be rotated to the left and right by 90° (with graduation). The clampable spindle sleeve is prepared for mounting of the fine feed adapter (see below). Tool holder using multiple range collets type ER 20: (DIN ISO 15488) One each of 6 – 8 – 10 and 12mm are included. Height adjustment of milling head via hand wheel. Solid plane-milled steel compound table with 3 continuous MICROMOT standard T-slots (12 x 6 x 5mm). All 3 hand wheels with graduated scale ring (1 rev. = 2mm).

Technical data:

230V. 400W. 50/60Hz. Spindle speeds 200 – 4,000rpm. Throat 125mm. Sleeve stroke 30mm. Column 120 x 100 x 430mm. Table 400 x 125mm. Transverse range vertical (Z-axis) 220mm, transverse (X-axis) 310mm, depth (Y-axis) 100mm. Dimensions: H = 750mm, W = 550mm, D = 550mm. Weight approx. 47kg.

NO 24 350

Multiple range standard type ER 20 collets (DIN ISO 15488)

For the miller FF 500/BL. But also for older versions of the Mill/drill head PF 400 (from production no. 401-10910) and of the miller FF 500 (from production no. 5648). High concentricity and repeat accuracy. May be reduced to 0.5mm below their nominal diameter (intermediate sizes not required). D = 21mm, L = 31.5mm. One each of 2.5 – 3 – 3.5 – 4 and 5mm are included. Supplied in a wooden box with sliding lid.

NO 24 253

Note:

Clamping jaws, miller and work piece are not included in the scope of delivery.



During milling operation the spindle sleeve may be clamped with a T-screw.

Note:
The miller FF 500/BL is also available as CNC version (see page 65).

Fine feed for accurate adjustments during milling for FF 500/BL

Quick and easy to install. The clutch system enables feed via either the drill handle or the handwheel. The handwheel has 0.025 graduations and may be set to zero. 1 division = 0.05mm.



NO 24 254

1 Automatic universal axial feed AV/E For even milling. Switchable to manual operation.

For the X axis of the milling machine FF 500/BL, predecessor compound table KT 400 and the milling machine FF 400. Special DC motor with speed control. Manual drive with freewheeling function and two speed levels: Stage 1 for common machining (20 – 65mm/min). Stage 2: for machining at higher speed or quick adjustment of the X axis (75 – 260mm/min). Simple assembly: mounted on the cross table with two screws.

Technical data:

230V. 100W. 50/60Hz. Spindle speeds 10 – 130rpm. Dimensions: H 120, W 170, D 210mm. Weight 3.5kg. Insulated to Class 1.

NO 24 326

2 Splash guard and chip collecting tray for PROXXON milling machines

Made of 1.5mm thick sheet steel, powder-coated. Secure stand due to drill holes for fastening to a work surface (the use of steel sleeves keeps the tray tightly sealed). L 700mm, W 420mm, H 40mm.

NO 24 322

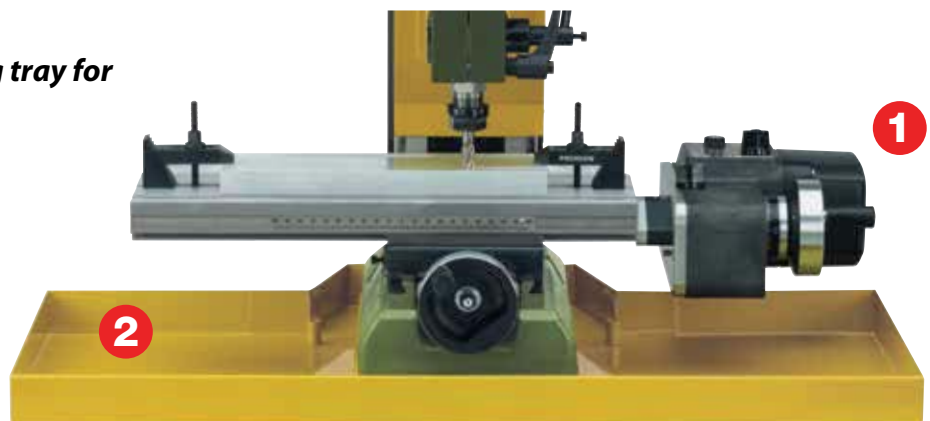



Digital position indicator DA 3.1

With large multi-function display, 3 glass rulers (with one sensor each) and fastening elements.

Reasonable for repetitive machining: A second start point in addition to the zero point can be set anywhere. Most important computing functions:

- Calculation and indication of a centre position
- Basic arithmetic operations
- Positioning of drill holes on any straight lines and circular paths
- Milling of inclined planes
- Milling of radii in different levels

Technical data:

Digital display 265 x 182 x 48mm for 110 – 230V, 50/60Hz. Glass rulers for travel distances: vertical (z-axis) 220mm, transverse (x-axis) 300mm, depth (y-axis) 100mm. With a 200cm metal-sheathed plug connection line to the display.

NO 24 323

MICROMOT adapter

For use with high-speed MICROMOT rotary tools

in combination with the millers FF 500/BL and FF 500/BL-CNC. The standard milling head is exchanged for the adapter in just a few steps. Our 20mm collar enables to fasten all appliances of the MICROMOT 60 series, the MICROMOT precision drill/grinder FBS 240/E and the MICROMOT professional drill/grinder IBS/E. Especially for applications that require high speeds for small milling cutters (e.g. milling electronic boards), but also for micro drilling. Complete with fastening screws.

NO 24 346



Universal dividing table UT 400

For accurate machining of circular work pieces.

The table may be fixed horizontally or vertically. Worm drive for division through 360° allowing for almost all possible divisions below 100. Supplied with 4 index plates: 27/42, 33/40, 34/39 and 36/38. Used to manufacture sprockets, gearboxes and drives, ratchets, cams, etc. (the faceplate is not included). The taper is identical to the main spindle of the lathe. With matching nuts and screws for fixation in MICROMOT standard T-slots (12 x 6 x 5mm). Supplied in a wooden box with sliding lid.

NO 24 421

Note:

The dividing table UT 400 is also available as CNC version (model UT 400/CNC, NO 24 423). You'll find a detailed description in the special brochure for PROXXON CNC products which you may request under NO 95 158 (German) or NO 95 372 (English). Or just browse our website at www.proxxon.com.

Miller FF 500/BL-CNC

Includes CNC controller and user-friendly software (runs under WINDOWS® with RS 232 interface). Double roller bearing mounted recirculating ball spindles on all 3 axes and 3 powerful step motors. Large travel distances: X-axis approx. 290mm, Y-axis approx. 100mm, Z-axis approx. 200mm. The mechanical design is almost identical to the MICRO Miller FF 500/BL (see page 63).

NO 24 360

Miller FF 500/BL-CNC-ready

As described here, but without controller and without software. Connection to the controller by three standard plugs (SUB-D 9POL).

NO 24 364

Note:

Step clamps, milling bit and work piece are not included in the scope of delivery.

Note:

For the lathe system PD 400/CNC and the miller FF 500/BL-CNC there is a special brochure with detailed description, which you may inquire for under NO 95 158 (German) or NO 95 372 (English). Or just visit our website at www.proxxon.com!



Lathe PD 400/CNC

Also this machine is supplied complete with CNC controller and user-friendly software (runs under WINDOWS®).

Axle drive via two powerful step motors and recirculating ball spindles. The mechanical design is almost identical to the proven PROXXON Lathe PD 400 (see pages 60/61).

NO 24 500



Note:

You will find these tools with a more detailed description on page 52 of the catalogue!



Also available individually: MICRO compound table KT 70/CNC-ready

With two step motors for the axes X (transverse) and Y (lengthwise).

MICRO Miller MF 70/CNC-ready

Interesting for users who already own a control unit or would like to purchase one from another provider on the market. With step motors for axes X (transverse), Y (lengthwise) and Z (high).



Nearly all accessories are supplied in wooden boxes. For proper and value preserving storage!



Radius cutting attachment

Is mounted on the cross slide in place of the tool holder. For producing convex and concave shapes, for turning radii or 3/4 spheres with radii of 32mm max. Height adjustable tool holder (boring tool tip adjustable from 30 through 45mm above cross slide) for use with FD 150/E, PD 250/E, PD 400 and older PROXXON lathes. Dimensions: base plate 67 x 50mm, height 55mm. Including finishing cutter 8 x 8 x 80mm.

In wooden box with sliding lid.
NO 24 062



Tool holder for rotary tools.
For use on lathe machines.



Made of steel with standard 20mm MICROMOT collar size.

For precise clamping of rotary tool IBS/E or LBS/E in the tool post of the lathe. Shaft 8 x 10mm. Total length 65mm.

NO 24 098

Step clamp set of steel

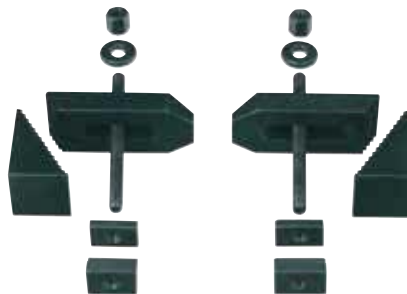

2 step blocks and clamps each.

With matching slot nuts and fastening screws for T-slots as per MICROMOT standard (12 x 6 x 5mm). In wooden box with sliding lid.

For work pieces up to 20mm thickness
NO 24 256

For work pieces up to 35mm thickness
NO 24 257

Die holder for round dies



For threads M 3 – 4 – 5 – 6 – 8 and 10.

With holder Ø 10mm for mounting in the tailstock drill chuck of the lathe. The holder is held by hand while cutting the threads. Neatly packed in wooden box with sliding lid.

NO 24 082

Precision-milled steel machine vices

Perfectly rectangular. To be placed sideways and on the end face. With matching slot nuts and fastening screws.

Supplied in wooden box with sliding lid.

Precision vice PM 40



Jaw width of 46mm. Clamping capacity 34mm. Total length 70mm.

NO 24 260

Precision vice PM 60



Jaw width 60mm. Clamping capacity 42mm. Total length 100mm.

NO 24 255

Precision V-blocks



Used to clamp various work pieces.

Made from hardened steel, precision ground in pairs. Four different depths of prism incisions V, all at 90°. Size 50 x 30 x 30mm. The solid clamp and knurled knob ensure superb securing of the workpiece.

Supplied in a wooden box with sliding lid.

NO 24 262

2 pieces

14-piece parallel supports set



Ground in pairs.

For adjusting work on drilling machines, lathes and milling machines.

Made of high-alloy, hardened steel (58 – 62 HRC). Parallel accuracy 0.002mm.

2 each of 8 x 10, 15, 20, 25, 30, 35 and 40mm. Length 100mm. Packed in a wooden box.

NO 24 266

Milling cutter set (2 – 5mm)

All cutters with 6mm shaft. Cutters of Ø 2 – 3 – 4 and 5mm. Double fluted according to DIN 327. Made of HSS-Co5. Comes in wooden box with sliding lid.
NO 24 610



Milling cutter set (6 – 10mm)

4 cutters Ø 6 – 7 – 8 and 10mm. Four flute design according to DIN 844. Shafts 6 and 10mm respectively. Made of HSS-Co5. Comes in wooden box with sliding lid.
NO 24 620



Three piece centre drill set

Made of HSS steel. DIN 333 (type A) 60°. Complete set centre drills with sizes of 2 – 2.5 and 3.15mm.



NO 24 630

Edge finder set



Used for fast and accurate location of starting point of work pieces with respect to the machine spindle on milling machines. Size 6 x 6 x 50mm and 6 x 5 x 75mm. Comes in wooden box with sliding lid.

NO 24 434

Parting tool holder and tool

Used in the PD 400 quick-change system. Used to part stock and cut slots. The 12 x 3 x 85mm HSS tool contains cobalt.



NO 24 417

Spare tool for parting tool holder

As described above.

NO 24 554

Cutting tools of high quality cobalt HSS steel, ground.

Five piece set

One each roughing out, parting, finishing cut, left and right cutter. Comes in wooden box with sliding lid.



8 x 8 x 80mm (for PD 230/E and PD 250/E)

NO 24 530

10 x 10 x 80mm (for PD 400)

NO 24 550

Three piece thread cutting set

One cutter for external thread (ground to 60°, metric) one for internal thread, one general cutting. Comes in wooden box with sliding lid.



8 x 8 x 80mm (for PD 230/E and PD 250/E)

NO 24 540

10 x 10 x 80mm (for PD 400)

NO 24 552

Cutting tool set for precision lathe FD 150/E.

Made of high-quality cobalt HSS steel. Ground, 6-piece.



One each boring, roughing out, parting, finishing, right and left cutter. Size 6 x 6 x 65mm. For FD 150/E. Comes in wooden box with sliding lid.

NO 24 524 6 pieces

Cutter set with tungsten inserts for PD 230/E, PD 250/E and PD 400



Three holders (90mm long)

① for roughing out;

② for longitudinal work;

③ for 90mm boring bar, holes from 12mm. Standard tungsten inserts, 55°, plated (commercially available version). Three additional inserts securing screw and key TX 8 are included.

NO 24 555 8 x 8mm

(for PD 230/E and PD 250/E)

NO 24 556 10 x 10mm

(for PD 400)

Tungsten disposable tips

For the holders as described above.

NO 24 557 Ten piece set.

HSS boring tool set, 6 pieces



One each cutter for 60 degree (metric) and 55 degree (Whitworth) inside threads, 1.3mm – 2.65mm and 4mm. Shaft of Ø 6mm. Length 95mm. The cutters are held by a tool holder (8 x 8mm) that mounts to the tool post of either the PD 230/E, PD 250/E or PD 400.

Comes in wooden box with sliding lid.

NO 24 520

Mill/drill system BFW 40/E, with controller for speeds of 900 – 6,000rpm.

The triple ball bearing armature provides direct drive (no gearing).
Die-cast aluminium head with spindle neck of 43mm (European standard). Large, easy to use switch with emergency function. Chart indicates optimum speeds for milling and drilling of various materials.

Other technical data:

Control unit with full wave electronics for 230V, 40VDC secondary voltage. Power consumption up to max. 250W.

Spindle speed infinitely variable between 900 and 6,000rpm. Complete with triple slit, hardened collets covering 2.35 – 3 – 3.2 – 4 – 5 and 6mm as well as one locking pin and one spanner.



NO 20 165

Note:

*The motor operates at 40V, supplied from the power pack/controller. At this level, the control characteristics are ideal and yield high torque, even at lower speeds.
(The compound table, drill stand and step clamps are not included.)*

**Die-cast aluminium compound table
KT 150**

With precision milled dovetail slides, thus also suitable for metal work.

For routing, milling, slotting of steel, non-ferrous metals, plastics and wood. Each slide provided with locking screws. With re-adjustable dovetail guides to eliminate play. Feed adjustment by means of 2 handwheels with graduated, zero-adjustable dials (1 revolution = 2mm feed, 1 graduation = 0.05mm feed). Plane-milled table.

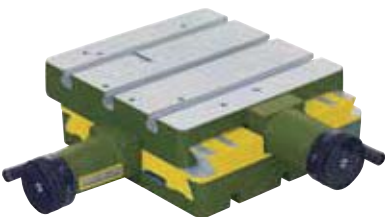

Three continuous MICRO-MOT standard T-slots (12 x 6 x 5mm). Fence with pre-drilled positioning holes, fastening screws. A practical screw clamp used when routing. Table 200 x 200mm. Maximum travel 150 x 150mm. Overall height 75mm. Weight

4.9kg. The step clamps depicted on the right are not included in the scope of delivery.

NO 20 150



**BFB 2000,
see page 69.**

Mill/drill unit BFB 2000

For standard drills with 43mm spindle neck.

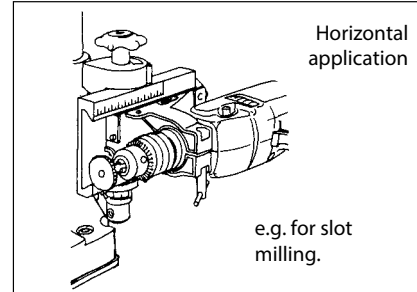
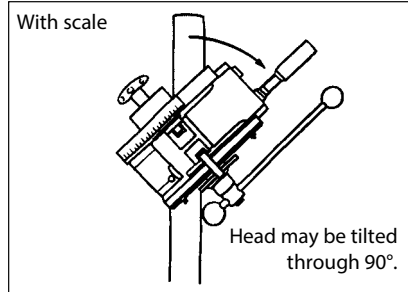
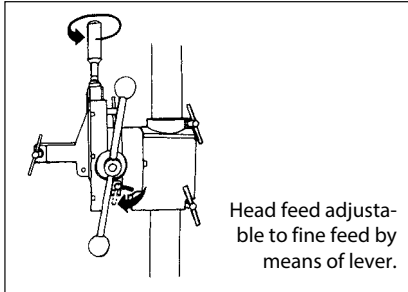

Head tilts through 90°, thus offering a multitude of capabilities:

Diagonal drilling, versatile milling without need of special milling bits, milling of diagonal slots.

Fine feed selectable allowing fine head feed for milling. With dial and depth scale. Geared rack and pinion feed for effortless drilling. 45mm diameter drill column, 500mm long. Approx. 140mm throat (column outside to tool centre). 65mm stroke. Plane-milled, solid base plate approx. 200 x 200mm with two continuous MICROMOT standard T-slots (12 x 6 x 5mm). Easy clamping of all common drills with standard 43mm spindle collar. Weight approx. 6.5kg.

NO 20 000

Note:

Our designers prefer die-cast aluminium. A refined, rust-proof and statically solid material. Fittings and feeds are machined on our highly modern CNC-controlled machines (milled, line-bored, lathed, etc.). Pure precision!

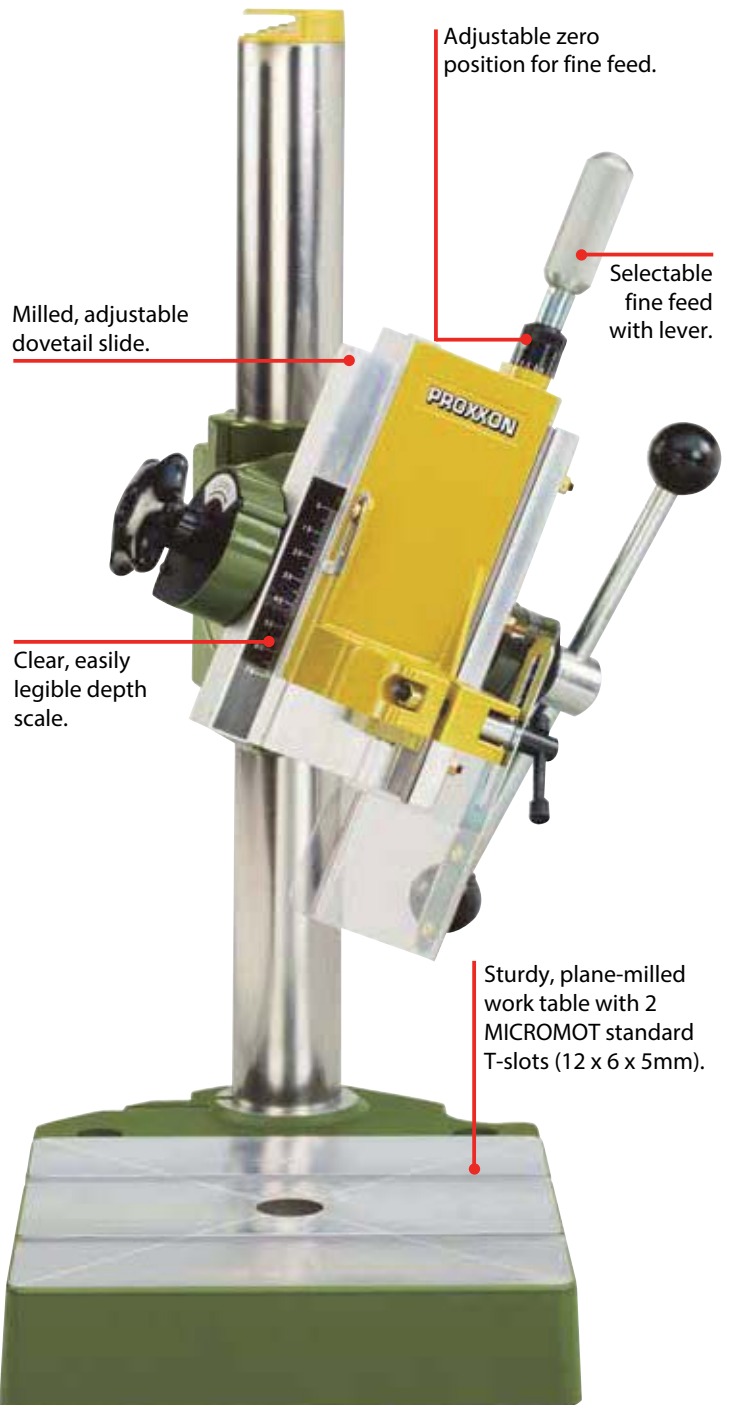

You will find precision machine vices PRIMUS 75 and PRIMUS 100 on pages 48/49 of this catalogue.



*Visible and tangible quality.
 Made for technology enthusiasts.*

		<i>Page/Pages</i>
	<i>Cordless tools</i>	<i>3 – 5</i>
	<i>Hand-held tools 230V</i>	<i>2 6 – 15 32</i>
	<i>Hand-held tools 12V and mains adapters</i>	<i>16 – 21 32</i>
	<i>Accessories for hand-held tools (drill stand, flexishaft, etc.)</i>	<i>20 22 – 23</i>
	<i>Bits and cutters (rotating) of industrial and dental quality</i>	<i>24 – 29</i>
	<i>Other precision tools and equipment for delicate work</i>	<i>30 – 31</i>
	<i>Lightweight to middleweight bench tools (with equipment-related accessories)</i>	<i>33 – 53</i>
	<i>Lathe and milling systems, including accessories</i>	<i>54 – 67</i>
	<i>Mill/drill system with 43mm-collar</i>	<i>68</i>
	<i>Accessories for mill/drill units with 43mm-collar</i>	<i>69</i>
	<i>Guide for creative model makers</i>	<i>51</i>

PROXXON GmbH
 Industriepark Region Trier
 Dieselstraße 3 - 7
 DE-54343 Föhren
 Tel.: +49(0) 65 02 - 93 17 - 0 • Fax +49(0) 65 02 - 93 17 - 200
 E-Mail: export@proxxon.com • www.proxxon.com



*A separate 38-page catalogue
 is available for PROXXON
 INDUSTRIAL hand tools. You may
 order it free of charge from the
 address given on the left.*

X-ON Electronics

Largest Supplier of Electrical and Electronic Components

Click to view similar products for [Control Switches](#) category:

Click to view products by [Proxxon](#) manufacturer:

Other Similar products are found below :

[80887-99](#) [80932-99](#) [86855-00](#) [88814-30](#) [1424293-1](#) [HW4S-2TC10](#) [89721-12](#) [89804-08](#) [SSN](#) [RL01801](#) [ASD2L20N-LVO](#) [50051857-17](#)
[50099156-001-05](#) [51.155R-15200](#) [50058920-26](#) [CP-FA51](#) [CP-FA49](#) [ACCU-SC/L-3000](#) [PP9M](#) [PP87G](#) [PP86GA](#) [PP71G](#) [PP70G](#) [PP6G](#)
[PP62G](#) [PP58BL](#) [PP56G](#) [PP86GB](#) [PP77GA](#) [PP76G](#) [PP4M](#) [PP47G](#) [PP46G](#) [PP41M](#) [PP40G](#) [PP32G](#) [RD-20](#) [PP23M](#) [PP12G](#) [PORTAPRO](#)
[POM-2708](#) [PNB-2005](#) [3057.0012](#) [CV-075](#) [CV-140SB](#) [CV-150](#) [CV-150S](#) [214X20XK](#) [CV-180](#) [CV-200MB](#)