

PE42482

Document Category: Product Specification

UltraCMOS® SP8T RF Switch, 10 MHz–8 GHz



Features

- High isolation: 41 dB @ 6 GHz
- Low insertion loss: 1.1 dB @ 6 GHz
- Fast switching time of 227 ns
- Power handling of 33 dBm CW
- Logic select (LS) pin provides maximum control logic flexibility
- Terminated all-off state mode
- Packaging – 24-lead 4 × 4 × 0.85 mm QFN

Applications

- Wireless infrastructure
- Wireless applications up to 8 GHz
- Filter bank switching
- RF signal routing

Figure 1 • PE42482 Functional Diagram

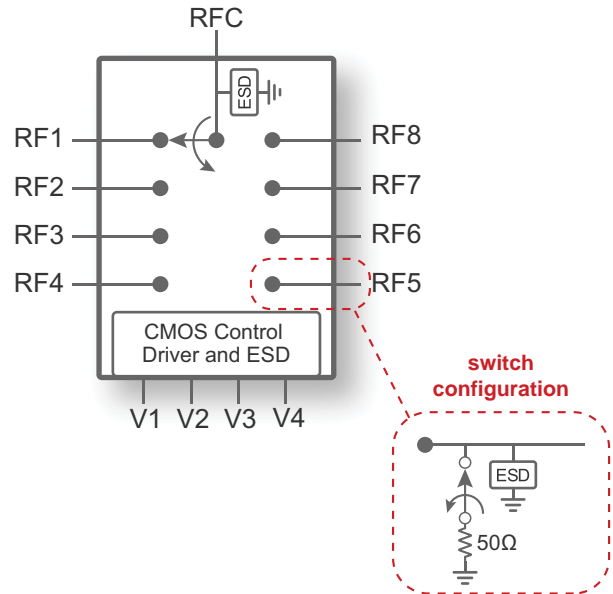

Product Description

The PE42482 is a HaRP™ technology-enhanced absorptive SP8T RF switch that supports a frequency range from 10 MHz to 8 GHz. It delivers high isolation, low insertion loss and fast switching time, making this device ideal for filter bank switching and RF signal routing in wireless infrastructure and wireless applications up to 8 GHz. No blocking capacitors are required if DC voltage is not present on the RF ports.

The PE42482 is manufactured on Peregrine’s UltraCMOS® process, a patented advanced form of silicon-on-insulator (SOI) technology.

Peregrine’s HaRP technology enhancements deliver high linearity and excellent harmonics performance. It is an innovative feature of the UltraCMOS process, offering the performance of GaAs with the economy and integration of conventional CMOS.

Absolute Maximum Ratings

Exceeding absolute maximum ratings listed in **Table 1** may cause permanent damage. Operation should be restricted to the limits in **Table 2**. Operation between operating range maximum and absolute maximum for extended periods may reduce reliability.

ESD Precautions

When handling this UltraCMOS device, observe the same precautions as with any other ESD-sensitive devices. Although this device contains circuitry to protect it from damage due to ESD, precautions should be taken to avoid exceeding the rating specified in **Table 1**.

Latch-up Immunity

Unlike conventional CMOS devices, UltraCMOS devices are immune to latch-up.

Table 1 • Absolute Maximum Ratings for PE42482

Parameter/Condition	Min	Max	Unit
Supply voltage, V_{DD}	-0.3	5.5	V
Digital input voltage (V1, V2, V3, V4, LS)	-0.3	3.6	V
RF input power (RFC–RFX, 50 Ω)		See Figure 2	dBm
RF input power into terminated ports, $CW^{(1)}$ (RFX, 50 Ω)		See Figure 2	dBm
Maximum junction temperature		+150	$^{\circ}\text{C}$
Storage temperature range	-65	+150	$^{\circ}\text{C}$
ESD voltage HBM, all pins ⁽²⁾		1000	V
ESD voltage CDM, all pins ⁽³⁾		1000	V
Notes: 1) 100% duty cycle, all bands, 50 Ω . 2) Human body model (MIL-STD 883 Method 3015). 3) Charged device model (JEDEC JESD22-C101).			

Recommended Operating Conditions

Table 2 lists the recommended operating conditions for the PE42482. Devices should not be operated outside the recommended operating conditions listed below.

Table 2 • Recommended Operating Conditions for PE42482

Parameter	Min	Typ	Max	Unit
Supply voltage, V_{DD}	2.3	3.3	5.5	V
Supply current, I_{DD}		120	200	μ A
Digital input high (V1, V2, V3, V4, LS)	1.17		3.6	V
Digital input low (V1, V2, V3, V4, LS)	-0.3		0.6	V
Digital input current V1, V2, V3, V4 LS			5 10	μ A μ A
RF input power, CW (RFC–RFX) ⁽¹⁾			See Figure 2	dBm
RF input power, pulsed (RFC–RFX) ⁽²⁾			See Figure 2	dBm
RF input power into terminated ports, CW (RFX) ⁽¹⁾			See Figure 2	dBm
Operating temperature range	-40	+25	+105	°C
Notes: 1) 100% duty cycle, all bands, 50 Ω . 2) Pulsed, 5% duty cycle of 4620 μ s period, 50 Ω .				

Electrical Specifications

Table 3 provides the PE42482 key electrical specifications at +25 °C, $V_{DD} = 3.3V$ ($Z_S = Z_L = 50\Omega$), unless otherwise specified.

Table 3 • PE42482 Electrical Specifications

Parameter	Path	Condition	Min	Typ	Max	Unit
Operating frequency			10 MHz		8 GHz	As shown
Insertion loss ⁽¹⁾	RFC–RF1/8	10–100 MHz		0.7	0.9	dB
		100 MHz–1 GHz		0.8	1.0	dB
		1–2 GHz		0.9	1.2	dB
		2–4 GHz		0.9	1.5	dB
		4–6 GHz		1.1	1.9	dB
		6–8 GHz		1.6	2.8	dB
	RFC–RF2/7	10–100 MHz		0.8	1.0	dB
		100 MHz–1 GHz		0.9	1.1	dB
		1–2 GHz		0.9	1.3	dB
		2–4 GHz		1.0	1.6	dB
		4–6 GHz		1.3	2.3	dB
		6–8 GHz		1.3	2.4	dB
	RFC–RF3/6	10–100 MHz		0.8	1.0	dB
		100 MHz–1 GHz		0.9	1.1	dB
		1–2 GHz		1.0	1.3	dB
		2–4 GHz		1.1	1.7	dB
		4–6 GHz		1.2	2.2	dB
		6–8 GHz		1.3	2.2	dB
	RFC–RF4/5	10–100 MHz		0.9	1.1	dB
		100 MHz–1 GHz		1.1	1.3	dB
1–2 GHz			1.2	1.6	dB	
2–4 GHz			1.3	1.9	dB	
4–6 GHz			1.4	2.2	dB	
6–8 GHz			1.5	2.8	dB	

Table 3 • PE42482 Electrical Specifications (Cont.)

Parameter	Path	Condition	Min	Typ	Max	Unit
Isolation ⁽¹⁾	RFC-RF1/8	10–100 MHz	61	65		dB
		100 MHz–1 GHz	45	47		dB
		1–2 GHz	39	41		dB
		2–4 GHz	34	36		dB
		4–6 GHz	29	32		dB
		6–8 GHz	25	30		dB
	RFC-RF2/7	10–100 MHz	63	67		dB
		100 MHz–1 GHz	50	53		dB
		1–2 GHz	45	47		dB
		2–4 GHz	38	41		dB
		4–6 GHz	30	34		dB
		6–8 GHz	29	34		dB
	RFC-RF3/6	10–100 MHz	64	68		dB
		100 MHz–1 GHz	51	53		dB
		1–2 GHz	46	48		dB
		2–4 GHz	38	40		dB
		4–6 GHz	33	35		dB
		6–8 GHz	29	31		dB
	RFC-RF4/5	10–100 MHz	81	85		dB
		100 MHz–1 GHz	57	62		dB
1–2 GHz		50	56		dB	
2–4 GHz		45	48		dB	
4–6 GHz		38	41		dB	
6–8 GHz		33	38		dB	

Table 3 • PE42482 Electrical Specifications (Cont.)

Parameter	Path	Condition	Min	Typ	Max	Unit
Return loss (active port)	RFC-RF1/8	10–100 MHz		25		dB
		100 MHz–1 GHz		24		dB
		1–2 GHz		24		dB
		2–4 GHz		21		dB
		4–6 GHz		26		dB
		6–8 GHz		13		dB
	RFC-RF2/7	10–100 MHz		24		dB
		100 MHz–1 GHz		23		dB
		1–2 GHz		20		dB
		2–4 GHz		18		dB
		4–6 GHz		15		dB
		6–8 GHz		16		dB
	RFC-RF3/6	10–100 MHz		24		dB
		100 MHz–1 GHz		23		dB
		1–2 GHz		18		dB
		2–4 GHz		15		dB
		4–6 GHz		12		dB
		6–8 GHz		12		dB
	RFC-RF4/5	10–100 MHz		24		dB
		100 MHz–1 GHz		23		dB
1–2 GHz			17		dB	
2–4 GHz			15		dB	
4–6 GHz			16		dB	
6–8 GHz			18		dB	

Table 3 • PE42482 Electrical Specifications (Cont.)

Parameter	Path	Condition	Min	Typ	Max	Unit
Return loss (RFC port)	RFC-RF1/8	10–100 MHz		25		dB
		100 MHz–1 GHz		23		dB
		1–2 GHz		24		dB
		2–4 GHz		23		dB
		4–6 GHz		24		dB
		6–8 GHz		12		dB
	RFC-RF2/7	10–100 MHz		24		dB
		100 MHz–1 GHz		23		dB
		1–2 GHz		21		dB
		2–4 GHz		19		dB
		4–6 GHz		20		dB
		6–8 GHz		18		dB
	RFC-RF3/6	10–100 MHz		24		dB
		100 MHz–1 GHz		23		dB
		1–2 GHz		19		dB
		2–4 GHz		16		dB
		4–6 GHz		13		dB
		6–8 GHz		13		dB
	RFC-RF4/5	10–100 MHz		24		dB
		100 MHz–1 GHz		22		dB
1–2 GHz			18		dB	
2–4 GHz			16		dB	
4–6 GHz			17		dB	
6–8 GHz			17		dB	

Table 3 • PE42482 Electrical Specifications (Cont.)

Parameter	Path	Condition	Min	Typ	Max	Unit
Return loss (terminated port)	RF1/8	10–100 MHz		16		dB
		100 MHz–1 GHz		15		dB
		1–2 GHz		15		dB
		2–4 GHz		15		dB
		4–6 GHz		18		dB
		6–8 GHz		21		dB
	RF2/7	10–100 MHz		16		dB
		100 MHz–1 GHz		15		dB
		1–2 GHz		15		dB
		2–4 GHz		15		dB
		4–6 GHz		18		dB
		6–8 GHz		19		dB
	RF3/6	10–100 MHz		16		dB
		100 MHz–1 GHz		15		dB
		1–2 GHz		15		dB
		2–4 GHz		15		dB
		4–6 GHz		16		dB
		6–8 GHz		19		dB
	RF4/5	10–100 MHz		16		dB
		100 MHz–1 GHz		15		dB
1–2 GHz			15		dB	
2–4 GHz			16		dB	
4–6 GHz			23		dB	
6–8 GHz			16		dB	
Relative insertion phase ⁽²⁾	RF2–RF1 (RF7–RF8)	1 GHz	–2.6	–1.3	0	Deg
		2 GHz	–4.7	–2.4	–0.1	Deg
		4 GHz	–7.5	–3.4	0.8	Deg
		6 GHz	–9.4	–2.8	3.8	Deg
		8 GHz	–1.4	4.4	10.1	Deg
	RF3–RF1 (RF6–RF8)	1 GHz	–3.0	–2.1	–1.3	Deg
		2 GHz	–5.8	–4.0	–2.1	Deg
		4 GHz	–9.3	–5.6	–1.9	Deg
		6 GHz	–11.2	–5.7	–0.3	Deg
		8 GHz	–10.2	–1.0	8.2	Deg
	RF4–RF1 (RF5–RF8)	1 GHz	–6.9	–5.6	–4.3	Deg
		2 GHz	–13.3	–10.7	–8.2	Deg
		4 GHz	–24.7	–18.9	–13.0	Deg
		6 GHz	–35.8	–26.3	–16.9	Deg
		8 GHz	–45.3	–31.5	–17.6	Deg
Input 1dB compression point ⁽³⁾	RFC–RFX			See Figure 2		dBm
Input 0.1dB compression point ⁽³⁾	RFC–RFX			See Figure 2		dBm

Table 3 • PE42482 Electrical Specifications (Cont.)

Parameter	Path	Condition	Min	Typ	Max	Unit
Input IP2	RFC–RFX	100 MHz–8 GHz		105		dBm
Input IP3	RFC–RFX	100 MHz–8 GHz		60		dBm
RF T _{RISE} /T _{FALL}		10%/90% RF		100	130	ns
Settling time		50% CTRL to 0.05 dB final value		870	1400	ns
Switching time		50% CTRL to 90% or 10% of RF		227	290	ns

Notes:

- 1) Insertion loss and isolation performance can be improved by a good RF ground on the LS pin (pin 1).
- 2) Defined with S-parameters, relative insertion phase (RFX–RF1) = $\angle S_{(x+1)1} - \angle S_{21}$, where incident Port-1 is RFC, response Port-2 = RF1, and response Port-(x+1) = RFX.
- 3) The input 1dB and 0.1dB compression point are linearity figures of merit. Refer to Table 2 for the RF input power (50Ω).

Switching Frequency

The PE42482 has a maximum 25 kHz switching frequency. Switching frequency describes the time duration between switching events. Switching time is the time duration between the point the control signal reached 50% of the final value and the point the output signal reaches within 10% or 90% of its target value.

Spurious Performance

The PE42482 spur fundamental occurs around 5 MHz. Its typical performance is –162 dBm/Hz, with 30 kHz bandwidth.

Hot-Switching Capability

The maximum hot switching capability of the PE42482 is 20 dBm above 100 MHz. Hot switching occurs when RF power is applied while switching between RF ports.

Thermal Data

Psi-JT (Ψ_{JT}), junction top-of-package, is a thermal metric to estimate junction temperature of a device on the customer application PCB (JEDEC JESD51-2).

$$\Psi_{JT} = (T_J - T_T)/P$$

where

Ψ_{JT} = junction-to-top of package characterization parameter, °C/W

T_J = die junction temperature, °C

T_T = package temperature (top surface, in the center), °C

P = power dissipated by device, Watts

Table 4 • Thermal Data for PE42482

Parameter	Typ	Unit
Ψ_{JT}	23	°C/W
Θ_{JA} , junction-to-ambient thermal resistance	63	°C/W

Control Logic

Table 5 provides the control logic truth table for PE42482.

Table 5 • Truth Table for PE42482

LS ⁽¹⁾	V4	V3	V2	V1	RFC–RF1	RFC–RF2	RFC–RF3	RFC–RF4	RFC–RF5	RFC–RF6	RFC–RF7	RFC–RF8
0	0	0	0	0	ON	OFF	OFF	OFF	OFF	OFF	OFF	OFF
0	0	1	0	0	OFF	ON	OFF	OFF	OFF	OFF	OFF	OFF
0	0	0	1	0	OFF	OFF	ON	OFF	OFF	OFF	OFF	OFF
0	0	1	1	0	OFF	OFF	OFF	ON	OFF	OFF	OFF	OFF
0	0	0	0	1	OFF	OFF	OFF	OFF	ON	OFF	OFF	OFF
0	0	1	0	1	OFF	OFF	OFF	OFF	OFF	ON	OFF	OFF
0	0	0	1	1	OFF	OFF	OFF	OFF	OFF	OFF	ON	OFF
0	0	1	1	1	OFF	OFF	OFF	OFF	OFF	OFF	OFF	ON
1	0	1	1	1	ON	OFF	OFF	OFF	OFF	OFF	OFF	OFF
1	0	0	1	1	OFF	ON	OFF	OFF	OFF	OFF	OFF	OFF
1	0	1	0	1	OFF	OFF	ON	OFF	OFF	OFF	OFF	OFF
1	0	0	0	1	OFF	OFF	OFF	ON	OFF	OFF	OFF	OFF
1	0	1	1	0	OFF	OFF	OFF	OFF	ON	OFF	OFF	OFF
1	0	0	1	0	OFF	OFF	OFF	OFF	OFF	ON	OFF	OFF
1	0	1	0	0	OFF	OFF	OFF	OFF	OFF	OFF	ON	OFF
1	0	0	0	0	OFF	OFF	OFF	OFF	OFF	OFF	OFF	ON
X ⁽²⁾	1	0	0	0	OFF	OFF	OFF	OFF	OFF	OFF	OFF	OFF

Notes:

- 1) LS has an internal 1 MΩ pull-up resistor to logic high. Connect LS to GND externally to generate a logic 0. Leaving LS floating will generate a logic 1.
- 2) LS = don't care, V4 = 1, V3 = V2 = V1 = 0, all ports are terminated to provide an all isolated state.

Power De-rating Curve

Figure 2 shows the power de-rating curve showing P1dB compression, P0.1dB compression, maximum RF input power (pulsed), maximum RF input power (CW), absolute maximum RF terminated power (CW), and maximum RF terminated power (CW).

Figure 2 • Power De-rating Curve, 10 MHz–8 GHz, –40 °C to +105 °C Ambient, 50Ω

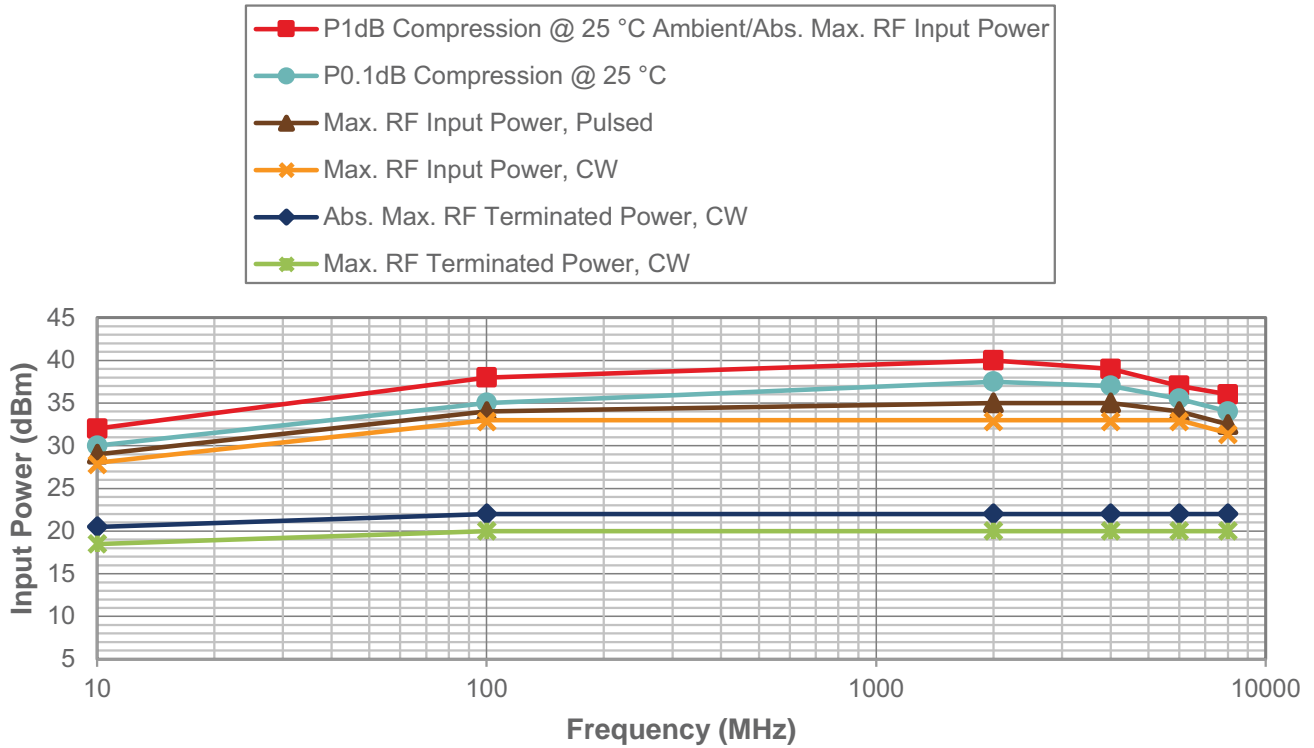

Isolation Matrix

Table 6 provides RFC-to-port isolation and Table 7 provides port-to-port isolation at +25 °C, $V_{DD} = 3.3V$ ($Z_S = Z_L = 50\Omega$).

Table 6 • RFC-to-Port Isolation

"ON" Port	Frequency	Isolation (dB)							
		RF1	RF2	RF3	RF4	RF5	RF6	RF7	RF8
RF1	10–100 MHz	–	69	68	85	91	88	87	79
	100 MHz–1 GHz	–	62	53	62	74	66	64	57
	1–2 GHz	–	57	48	56	68	60	58	51
	2–4 GHz	–	48	40	49	63	54	52	45
	4–6 GHz	–	37	35	44	55	50	46	42
	6–8 GHz	–	34	31	41	56	47	45	38
RF2	10–100 MHz	67	–	69	90	91	88	86	77
	100 MHz–1 GHz	52	–	60	67	74	66	64	56
	1–2 GHz	46	–	57	62	68	60	57	50
	2–4 GHz	39	–	49	54	63	53	52	45
	4–6 GHz	32	–	43	49	56	50	46	42
	6–8 GHz	30	–	37	46	55	47	46	40
RF3	10–100 MHz	65	68	–	86	91	88	85	77
	100 MHz–1 GHz	47	55	–	66	74	66	63	55
	1–2 GHz	42	51	–	57	68	60	57	50
	2–4 GHz	36	44	–	50	63	53	52	45
	4–6 GHz	33	40	–	42	56	49	47	42
	6–8 GHz	31	36	–	39	55	46	47	40
RF4	10–100 MHz	65	67	68	–	90	89	85	76
	100 MHz–1 GHz	47	53	56	–	75	66	63	55
	1–2 GHz	41	47	51	–	69	59	57	49
	2–4 GHz	36	41	44	–	63	53	51	44
	4–6 GHz	33	36	38	–	55	49	46	41
	6–8 GHz	32	34	34	–	50	47	47	40
RF5	10–100 MHz	73	84	89	90	–	68	68	66
	100 MHz–1 GHz	51	61	65	75	–	57	53	49
	1–2 GHz	45	56	59	68	–	52	48	44
	2–4 GHz	40	49	52	61	–	45	41	38
	4–6 GHz	37	45	48	56	–	39	36	35
	6–8 GHz	34	43	46	51	–	34	35	34
RF6	10–100 MHz	73	84	88	93	85	–	68	66
	100 MHz–1 GHz	51	62	65	73	64	–	56	50
	1–2 GHz	45	56	59	67	56	–	51	45
	2–4 GHz	40	49	53	61	48	–	46	39
	4–6 GHz	37	46	49	57	41	–	38	35
	6–8 GHz	34	44	45	55	38	–	37	33

Table 6 • RFC-to-Port Isolation (Cont.)

"ON" Port	Frequency	Isolation (dB)							
		RF1	RF2	RF3	RF4	RF5	RF6	RF7	RF8
RF7	10–100 MHz	73	84	89	92	88	69	–	68
	100 MHz–1 GHz	51	62	65	73	68	60	–	57
	1–2 GHz	45	56	59	67	63	57	–	52
	2–4 GHz	40	49	53	61	56	50	–	44
	4–6 GHz	37	45	49	57	50	41	–	33
	6–8 GHz	34	43	46	56	47	38	–	33
RF8	10–100 MHz	74	84	87	93	85	68	69	–
	100 MHz–1 GHz	52	62	66	73	63	54	65	–
	1–2 GHz	46	57	60	67	57	48	60	–
	2–4 GHz	40	49	53	60	50	41	51	–
	4–6 GHz	37	46	49	57	46	35	34	–
	6–8 GHz	33	42	46	55	42	31	35	–

Table 7 • Port-to-Port Isolation

"ON" Port	Frequency	Isolation (dB)							
		RF1	RF2	RF3	RF4	RF5	RF6	RF7	RF8
RF1	10–100 MHz	–	65	67	84	91	89	89	88
	100 MHz–1 GHz	–	47	51	59	75	69	71	64
	1–2 GHz	–	41	45	53	70	63	65	60
	2–4 GHz	–	35	39	47	64	57	60	53
	4–6 GHz	–	31	34	43	57	52	47	45
	6–8 GHz	–	29	30	40	57	49	47	43
RF2	10–100 MHz	65	–	64	78	90	91	92	89
	100 MHz–1 GHz	46	–	45	55	75	70	75	74
	1–2 GHz	41	–	39	49	69	64	69	72
	2–4 GHz	35	–	34	43	65	58	64	63
	4–6 GHz	32	–	30	41	57	53	50	51
	6–8 GHz	29	–	27	38	58	50	50	51
RF3	10–100 MHz	67	65	–	69	94	90	92	91
	100 MHz–1 GHz	51	47	–	47	75	70	78	80
	1–2 GHz	46	41	–	41	70	64	72	79
	2–4 GHz	40	36	–	36	65	58	66	68
	4–6 GHz	37	33	–	33	57	53	51	54
	6–8 GHz	33	30	–	30	57	50	51	54
RF4	10–100 MHz	68	67	63	–	90	89	89	91
	100 MHz–1 GHz	53	52	44	–	71	69	78	79
	1–2 GHz	47	46	39	–	66	64	71	80
	2–4 GHz	42	41	33	–	61	58	65	68
	4–6 GHz	38	36	30	–	54	53	50	54
	6–8 GHz	34	35	28	–	55	50	50	54

Table 7 • Port-to-Port Isolation (Cont.)

"ON" Port	Frequency	Isolation (dB)							
		RF1	RF2	RF3	RF4	RF5	RF6	RF7	RF8
RF5	10–100 MHz	88	91	89	90	–	63	67	68
	100 MHz–1 GHz	79	80	70	71	–	44	52	52
	1–2 GHz	66	73	64	66	–	39	46	46
	2–4 GHz	57	66	58	61	–	33	41	40
	4–6 GHz	50	52	53	55	–	30	36	36
	6–8 GHz	47	53	51	56	–	28	35	33
RF6	10–100 MHz	90	92	89	91	69	–	65	67
	100 MHz–1 GHz	77	82	70	75	46	–	47	51
	1–2 GHz	65	75	65	70	41	–	42	45
	2–4 GHz	56	66	58	64	35	–	36	39
	4–6 GHz	49	52	53	59	33	–	32	35
	6–8 GHz	46	53	50	57	30	–	31	32
RF7	10–100 MHz	92	92	89	90	78	64	–	64
	100 MHz–1 GHz	85	77	70	76	55	45	–	45
	1–2 GHz	70	72	64	71	50	39	–	40
	2–4 GHz	57	64	58	65	44	34	–	35
	4–6 GHz	48	52	53	59	40	30	–	29
	6–8 GHz	46	51	50	57	39	27	–	30
RF8	10–100 MHz	87	91	88	90	82	67	65	–
	100 MHz–1 GHz	69	73	69	75	59	51	47	–
	1–2 GHz	67	67	63	70	54	45	41	–
	2–4 GHz	56	61	57	64	47	39	35	–
	4–6 GHz	46	49	52	59	43	34	29	–
	6–8 GHz	42	49	49	56	41	30	29	–

Typical Performance Data

Figure 3–Figure 20 show the typical performance data at +25 °C, $V_{DD} = 3.3V$ ($Z_S = Z_L = 50\Omega$), unless otherwise specified.

Figure 3 • Insertion Loss vs. Frequency (RFC–RFx)

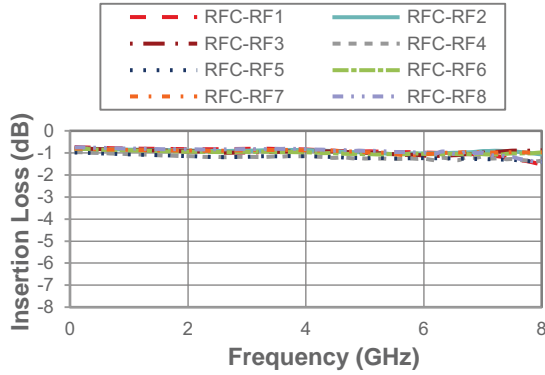

Figure 5 • Insertion Loss vs. Frequency Over V_{DD} (RFC–RF1)

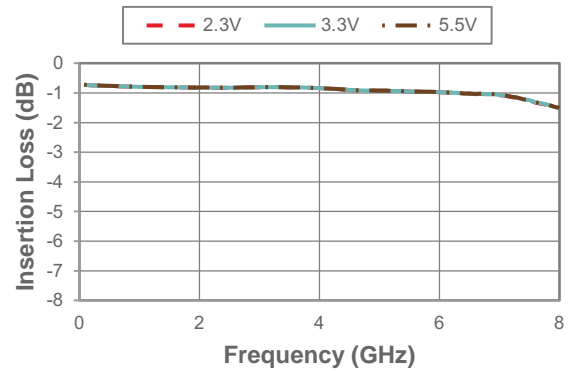

Figure 4 • Insertion Loss vs. Frequency Over Temperature (RFC–RF1)

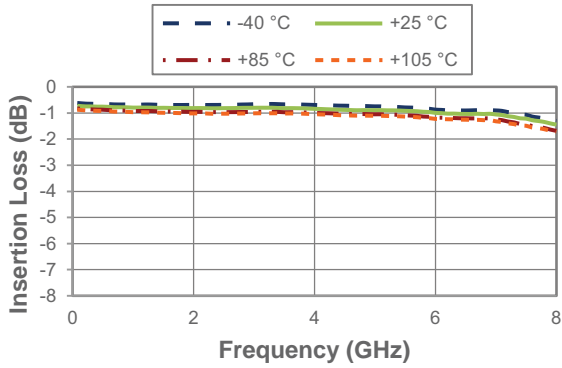

Figure 6 • RFC Port Return Loss vs. Frequency

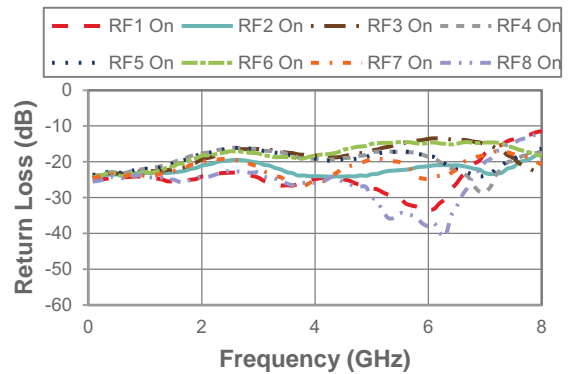

Figure 7 • RFC Port Return Loss vs. Frequency Over Temperature (RF1 On)

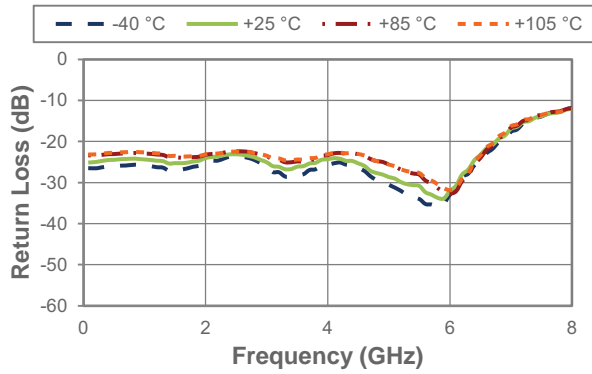

Figure 10 • RF1 Active Port Return Loss vs. Frequency Over Temperature

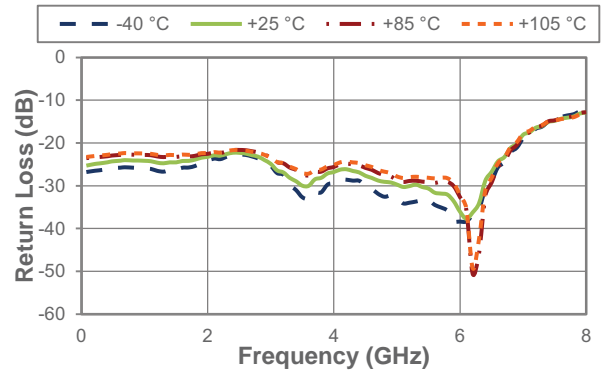

Figure 8 • RFC Port Return Loss vs. Frequency Over V_{DD} (RF1 On)

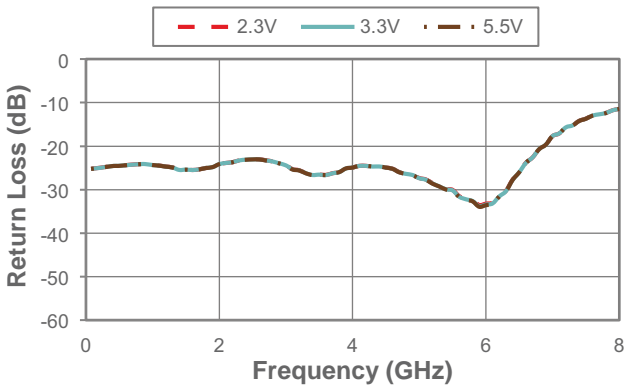

Figure 11 • RF1 Active Port Return Loss vs. Frequency Over V_{DD}

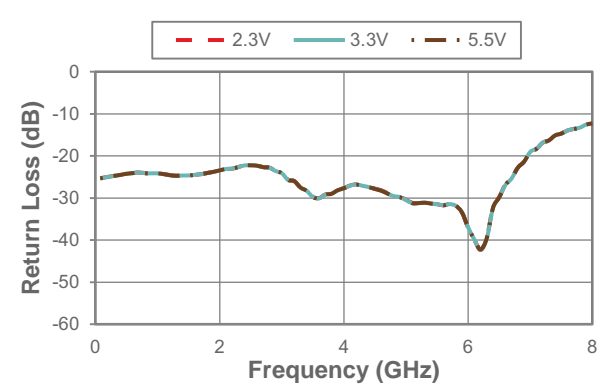

Figure 9 • Active Port Return Loss vs. Frequency

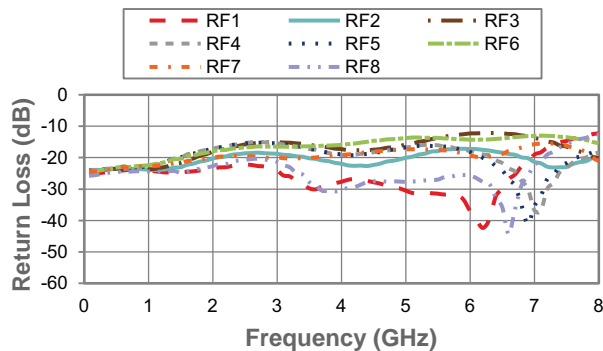

Figure 12 • Terminated Port Return Loss vs. Frequency (RF1 On)

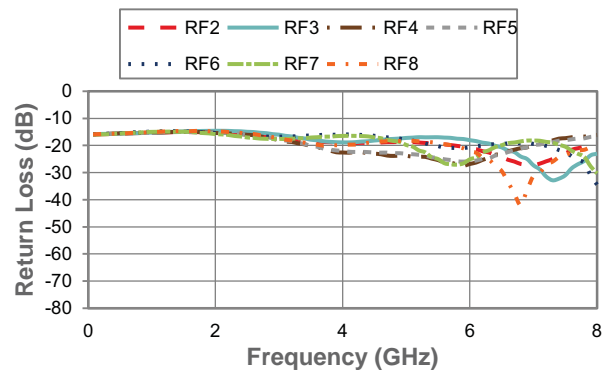

Figure 13 • RF2 Terminated Port Return Loss vs. Frequency Over Temperature (RF1 On)

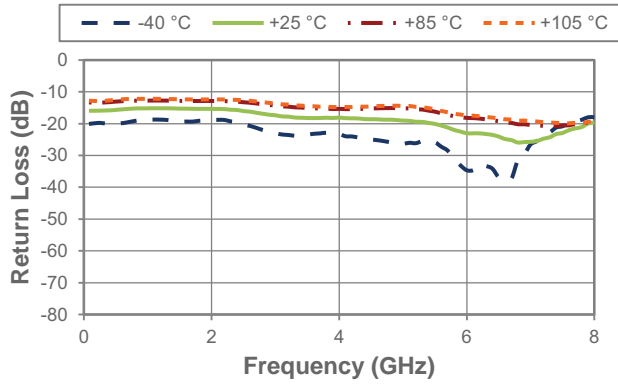

Figure 16 • Isolation vs. Frequency Over V_{DD} (RF1–RF2, RF1 On)

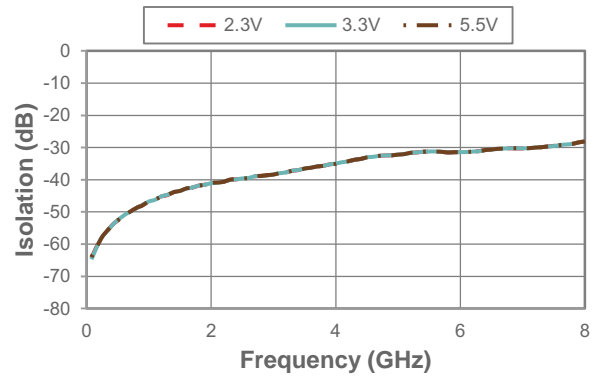

Figure 14 • RF2 Terminated Port Return Loss vs. Frequency Over V_{DD} (RF1 On)

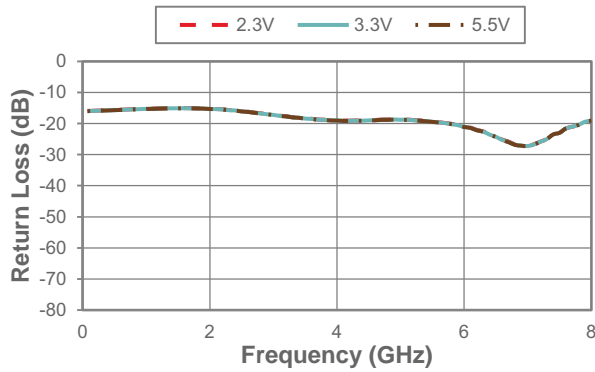

Figure 17 • Isolation vs. Frequency Over Temperature (RFC–RF2, RF1 On)

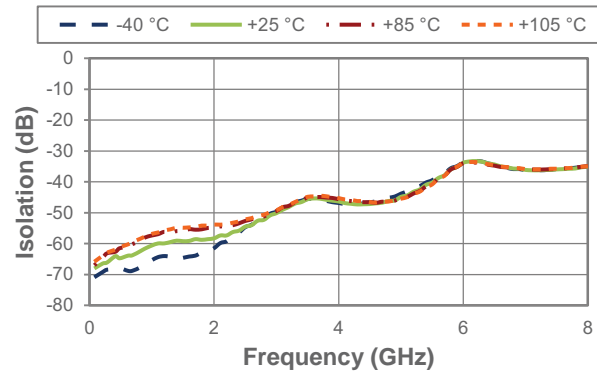

Figure 15 • Isolation vs. Frequency Over Temperature (RF1–RF2, RF1 On)

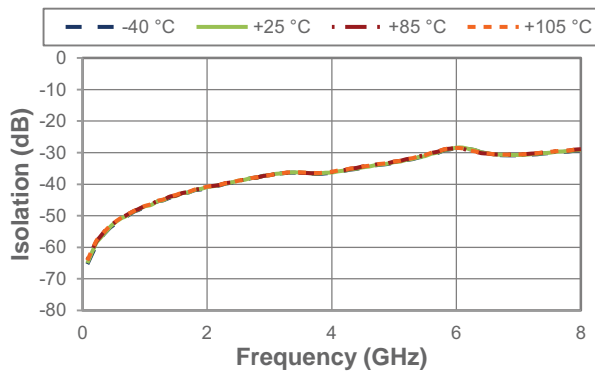

Figure 18 • Isolation vs. Frequency Over V_{DD} (RFC–RF2, RF1 On)

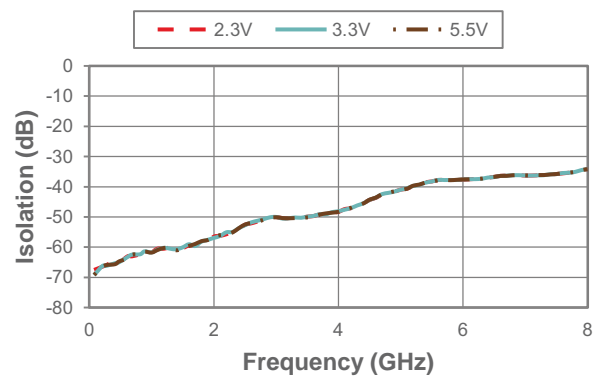

Figure 19 • IIP2 vs. RF Port Measured

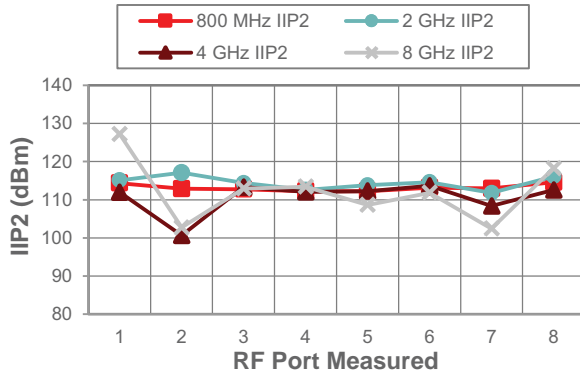
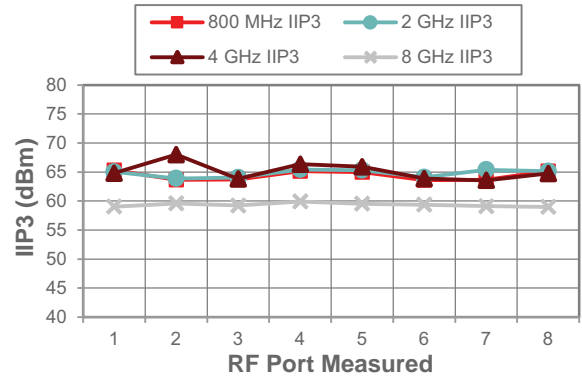

Figure 20 • IIP3 vs. RF Port Measured



Evaluation Kit

The high-throw count RF switch evaluation kit (EVK) includes hardware required to control and evaluate the functionality of the high-throw count switches. The high-throw count RF switch evaluation software can be downloaded at www.psemi.com and requires a PC running Windows® operating system to control the USB interface board. Refer to the *Multi-throw Count RF Switch Evaluation Kit (EVK) User's Manual* for more information.

Figure 21 • Evaluation Board Layout for PE42482

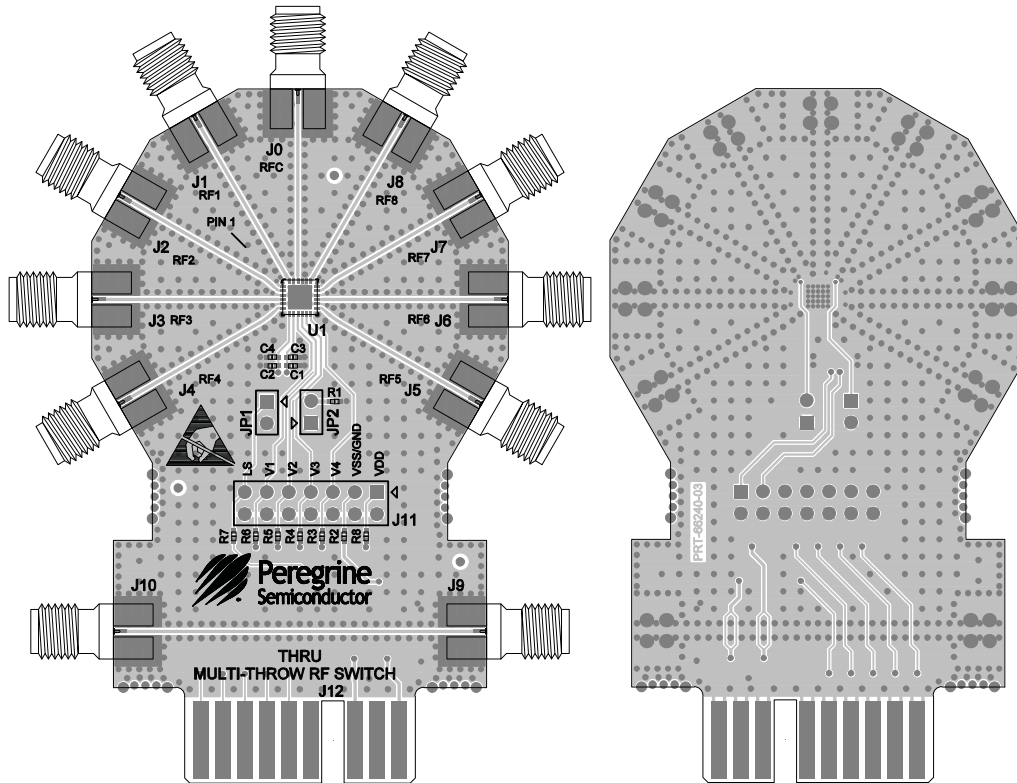

Pin Information

This section provides pinout information for the PE42482. Figure 22 shows the pin map of this device for the available package. Table 8 provides a description for each pin.

Figure 22 • Pin Configuration (Top View)

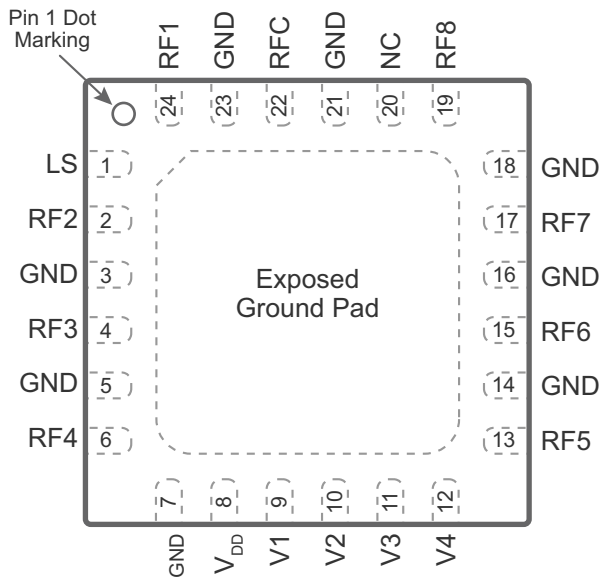

Table 8 • Pin Descriptions for PE42482

Pin No.	Pin Name	Description
1	LS	Logic Select—used to determine the definition for V1, V2, V3 and V4 pins
2	RF2 ⁽¹⁾	RF port 2
3, 5, 7, 14, 16, 18, 21, 23	GND	Ground
4	RF3 ⁽¹⁾	RF port 3
6	RF4 ⁽¹⁾	RF port 4
8	V _{DD}	Supply voltage (nominal 3.3V)
9	V1	Digital control logic input 1
10	V2	Digital control logic input 2
11	V3	Digital control logic input 3
12	V4	Digital control logic input 4
13	RF5 ⁽¹⁾	RF port 5
15	RF6 ⁽¹⁾	RF port 6
17	RF7 ⁽¹⁾	RF port 7
19	RF8 ⁽¹⁾	RF port 8
20	NC ⁽²⁾	No connect
22	RFC ⁽¹⁾	RF common port
24	RF1 ⁽¹⁾	RF port 1
Pad	GND	Exposed pad: ground for proper operation
Notes: 1) RF pins 2, 4, 6, 13, 15, 17, 19, 22, and 24 must be at 0 VDC. The RF pins do not require DC blocking capacitors for proper operation if the 0 VDC requirement is met. 2) Pin 20 (NC) can be connected to GND or left not connected externally.		

Packaging Information

This section provides packaging data including the moisture sensitivity level, package drawing, package marking and tape-and-reel information.

Moisture Sensitivity Level

The moisture sensitivity level rating for the PE42482 in the 24-lead 4 × 4 × 0.85 mm QFN package is MSL1.

Package Drawing

Figure 23 • Package Mechanical Drawing for 24-lead 4 × 4 × 0.85 mm QFN

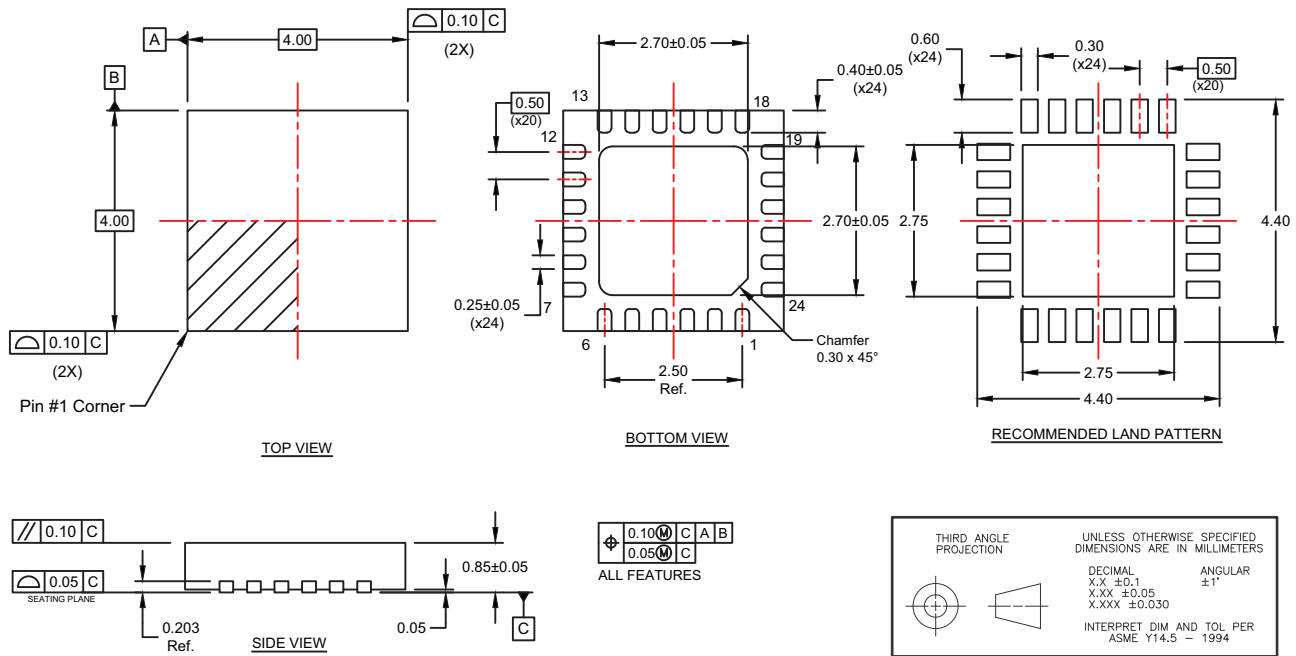

Top-Marking Specification

Figure 24 • Package Marking Specifications for PE42482

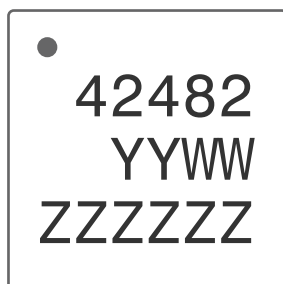

- = Pin 1 indicator
- YY = Last two digits of assembly year
- WW = Assembly work week
- ZZZZZZ = Assembly lot code (Maximum six characters)

Tape and Reel Specification

Figure 25 • Tape and Reel Specifications for 24-lead 4 × 4 × 0.85 mm QFN

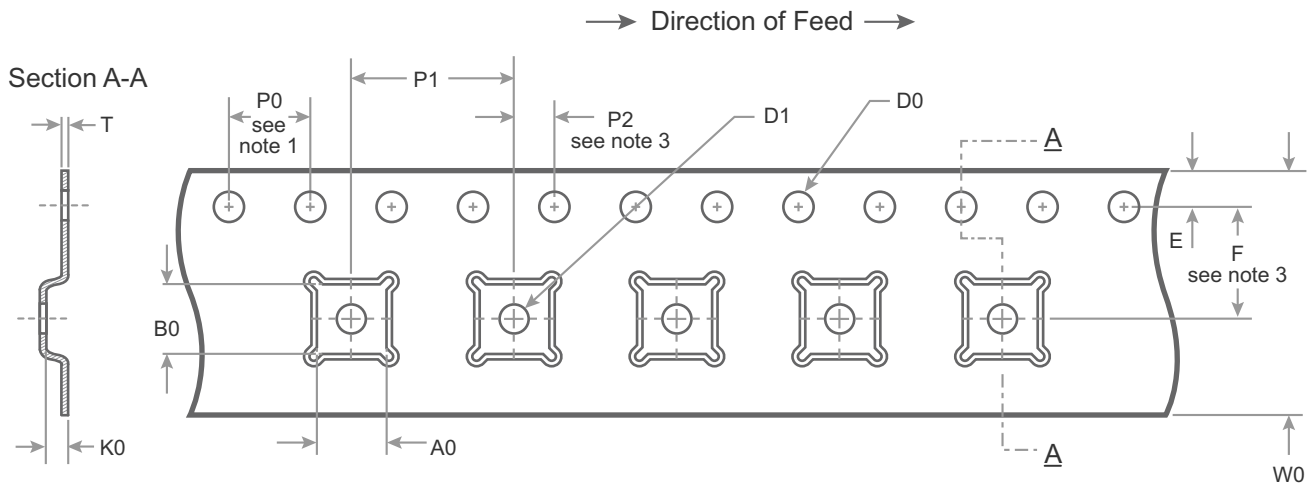

A0	4.35
B0	4.35
K0	1.10
D0	1.50 + 0.10/ -0.00
D1	1.50 min
E	1.75 ± 0.10
F	5.50 ± 0.05
P0	4.00
P1	8.00
P2	2.00 ± 0.05
T	0.30 ± 0.05
W0	12.00 ± 0.30

Notes:

1. 10 Sprocket hole pitch cumulative tolerance ±0.2
2. Camber in compliance with EIA 481
3. Pocket position relative to sprocket hole measured as true position of pocket, not pocket hole

Dimensions are in millimeters unless otherwise specified

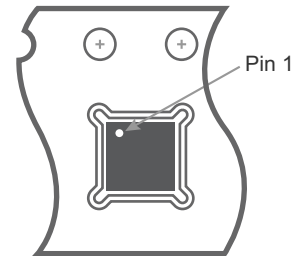

Device Orientation in Tape

Ordering Information

Table 9 lists the available ordering codes for the PE42482 as well as available shipping methods.

Table 9 • Order Codes for PE42482

Order Codes	Description	Packaging	Shipping Method
PE42482A-X	PE42482 SP8T RF switch	Green 24-lead 4 x 4 mm QFN	500 units/T&R
EK42482-02	PE42482 Evaluation kit	Evaluation kit	1/Box

Document Categories

Advance Information

The product is in a formative or design stage. The datasheet contains design target specifications for product development. Specifications and features may change in any manner without notice.

Preliminary Specification

The datasheet contains preliminary data. Additional data may be added at a later date. Peregrine reserves the right to change specifications at any time without notice in order to supply the best possible product.

Product Specification

The datasheet contains final data. In the event Peregrine decides to change the specifications, Peregrine will notify customers of the intended changes by issuing a CNF (Customer Notification Form).

Sales Contact

For additional information, contact Sales at sales@psemi.com.

Disclaimers

The information in this document is believed to be reliable. However, Peregrine assumes no liability for the use of this information. Use shall be entirely at the user's own risk. No patent rights or licenses to any circuits described in this document are implied or granted to any third party. Peregrine's products are not designed or intended for use in devices or systems intended for surgical implant, or in other applications intended to support or sustain life, or in any application in which the failure of the Peregrine product could create a situation in which personal injury or death might occur. Peregrine assumes no liability for damages, including consequential or incidental damages, arising out of the use of its products in such applications.

Patent Statement

Peregrine products are protected under one or more of the following U.S. patents: patents.psemi.com

Copyright and Trademark

©2017, Peregrine Semiconductor Corporation. All rights reserved. The Peregrine name, logo, UTSi and UltraCMOS are registered trademarks and HaRP, MultiSwitch and DuNE are trademarks of Peregrine Semiconductor Corp.

X-ON Electronics

Largest Supplier of Electrical and Electronic Components

Click to view similar products for [psemi](#) manufacturer:

Other Similar products are found below :

[EK42430-01](#) [EK42522-02](#) [EK4259-01](#) [EK42822-01](#) [EK43205-01](#) [EK43712-02](#) [EK64907-11](#) [EK64909-11](#) [EK64904-12](#) [EK45140-02](#)
[EK42820-02](#) [PE42582A-X](#) [PE42524A](#) [PE42820B](#) [PE42823A](#) [PE42542B](#) [PE42512A](#) [PE42020A](#) [PE42522B](#) [EK43205-02](#) [EK64904-13](#)
[EK42462-02](#) [PE426482A-X](#) [EK42542-03](#) [EK42442-01](#) [EK45450-02](#) [EK43705-11](#) [EK42721-02](#) [EK42641-04](#) [EK42422-01](#) [EK4256-01](#)
[EK4250-01](#) [EK42451-01](#) [EK4314-02](#) [EK64102-12](#) [EK43712-03](#) [EK42520-03](#) [EK42521-03](#) [EK423422-01](#) [EK42424-01](#) [EK46120-02](#)
[EK42742-03](#) [EK42421-01](#) [EK42359-01](#) [EK42723-01](#) [EK42522-03](#) [4270-00](#) [EK42420-04](#) [4257-00](#) [EK43704-12](#)