

### PE42427

#### UltraCMOS® SPDT RF Switch 5-6000 MHz

##### Features

- Symmetric SPDT reflective switch
- Low insertion loss
  - 0.23 dB typical @ 100 MHz
  - 0.25 dB typical @ 1000 MHz
  - 0.40 dB typical @ 3000 MHz
  - 0.65 dB typical @ 5000 MHz
  - 0.90 dB typical @ 6000 MHz
- Low spurious performance of -163 dBm/Hz
- Wide supply range of 2.3-5.5V
- Excellent linearity
  - IIP2 of 105 dBm @ 17 MHz
  - IIP3 of 81 dBm @ 17 MHz
- High ESD tolerance
  - 4 kV HBM on RF pins to GND
  - 1 kV on all other pins
- Logic Select (LS) pin provides maximum flexibility of control logic
- 12-lead 2 x 2 mm QFN package

##### Product Description

The PE42427 is a HaRP™ technology-enhanced SPDT RF switch designed to cover a broad range of applications from 5-6000 MHz. This reflective switch integrates on-board CMOS control logic with a low voltage CMOS-compatible control interface and requires no external components.

pSemi's HaRP technology enhancements deliver high linearity and exceptional harmonics performance. It is an innovative feature of the UltraCMOS® process, providing performance superior to GaAs with the economy and integration of conventional CMOS.

**Figure 1. Functional Diagram**

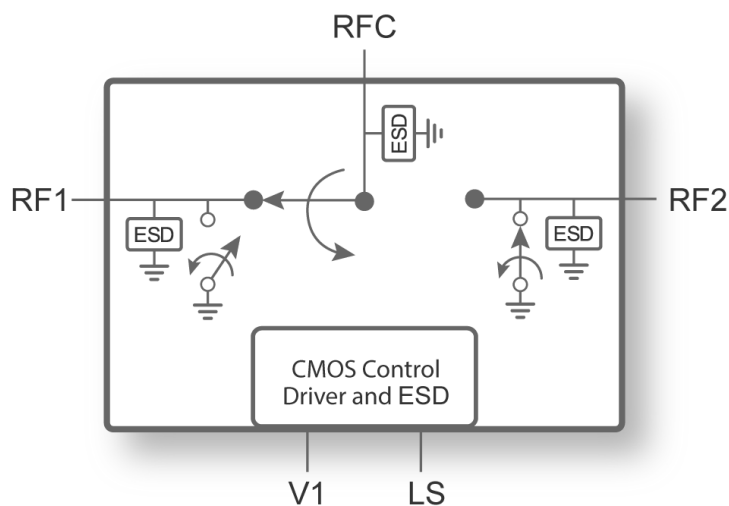

71-0068

**Figure 2. Package Type**

12-lead 2 x 2 x 0.55 mm QFN

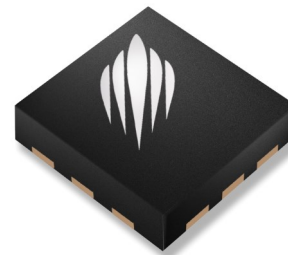

**Table 1. Electrical Specifications @ +25 °C<sup>1</sup>, V<sub>DD</sub> = 2.3-5.5V (Z<sub>S</sub> = Z<sub>L</sub> = 50Ω), unless otherwise specified**

Parameter	Path	Condition	Min	Typ	Max	Unit
Operational frequency			5		6000	MHz
Insertion loss <sup>2</sup>	RFX-RFC	5-100 MHz		0.23		dB
		100-1000 MHz		0.25	0.35	dB
		1000-2000 MHz		0.30	0.40	dB
		2000-3000 MHz		0.40	0.50	dB
		3000-4000 MHz		0.50	0.70	dB
		4000-5000 MHz		0.65	0.90 <sup>2</sup>	dB
		5000-6000 MHz		0.90	1.25 <sup>2</sup>	dB
Isolation	RFX-RFC	5-100 MHz		68		dB
		100-1000 MHz	42	44		dB
		1000-2000 MHz	33	35		dB
		2000-3000 MHz	27	29		dB
		3000-4000 MHz	22	24		dB
		4000-5000 MHz	18	20		dB
		5000-6000 MHz	15	17		dB
Isolation	RFX-RFX	5-100 MHz		61		dB
		100-1000 MHz	40	41		dB
		1000-2000 MHz	32	33		dB
		2000-3000 MHz	26	28		dB
		3000-4000 MHz	22	24		dB
		4000-5000 MHz	18	20		dB
		5000-6000 MHz	15	16		dB
Return loss <sup>2</sup>	RFX-RFC	5-100 MHz		33		dB
		100-1000 MHz		28		dB
		1000-2000 MHz		21		dB
		2000-3000 MHz		20		dB
		3000-4000 MHz		18		dB
		4000-5000 MHz		16 <sup>2</sup>		dB
		5000-6000 MHz		13 <sup>2</sup>		dB
2nd harmonic	RFX-RFC	+18 dBm input power, 17-204 MHz		-92		dBc
		+32 dBm output power, 850 / 900 MHz		-99		dBc
		+32 dBm output power, 1800 / 1900 MHz		-101		dBc
3rd harmonic	RFX-RFC	+18 dBm input power, 17-204 MHz		-125		dBc
		+32 dBm output power, 850 / 900 MHz		-93		dBc
		+32 dBm output power, 1800 / 1900 MHz		-87		dBc
IMD3	RF-RFC	Bands I, II, V, VIII +17 dBm CW @ TX freq at RFC, -15 dBm CW @ 2Tx-Rx at RFC, 50Ω		-115		dBm

**Table 1. Electrical Specifications @ +25 °C<sup>1</sup>, V<sub>DD</sub> = 2.3-5.5V (Z<sub>S</sub> = Z<sub>L</sub> = 50Ω), unless otherwise specified**

Parameter	Path	Condition	Min	Typ	Max	Unit
IIP2	RFX	5 MHz		96		dBm
		17 MHz		105		dBm
		100-6000 MHz		115		dBm
IIP3	RFX	5 MHz		75		dBm
		17 MHz		81		dBm
		100-6000 MHz		75		dBm
Input 0.1dB compression point <sup>3</sup>	RFX or RFC	5-100 MHz		33		dBm
		100-6000 MHz		34		dBm
Switching time		50% CTRL to (10%-90%) or (90%-10%) RF		2	4	μs

Notes: 1. Typical performance over temperature and V<sub>DD</sub> shown in *Figure 5* through *Figure 21*.

2. High frequency performance can be improved by external matching (see *Figure 22* through *Figure 27* and *Figure 30*).

3. The input P0.1dB compression point is a linearity figure of merit. Refer to *Table 5* for the operating RF input power.

## Switching Frequency

The PE42427 has a maximum 25 kHz switching frequency. Switching frequency describes the time duration between switching events. Switching time is the time duration between the point the control signal reached 50% of the final value and the point the output signal reaches within 10% or 90% of its target value.

## Spurious Performance

The PE42427 spur fundamental occurs around 13 MHz. Its typical performance is -163 dBm/Hz, with 200 kHz bandwidth. The performance is ideally suited for cable broadband applications.

Pin 4 should also be left unconnected for optimal spurious performance.

## Thermal Data

Psi-JT (Ψ<sub>JT</sub>), junction top-of-package, is a thermal metric to estimate junction temperature of a device on the customer application PCB (JEDEC JESD51-2).

$$\Psi_{JT} = (T_J - T_T)/P$$

where

Ψ<sub>JT</sub> = junction-to-top of package characterization parameter, °C/W

T<sub>J</sub> = die junction temperature, °C

T<sub>T</sub> = package temperature (top surface, in the center), °C

P = power dissipated by device, Watts

**Table 2. Thermal Data for PE42427**

Parameter	Typ	Unit
Y <sub>JT</sub>	48	°C/W
Q <sub>JA</sub> junction-to-ambient thermal resistance	145	°C/W

Figure 3. Pin Configuration (Top View)

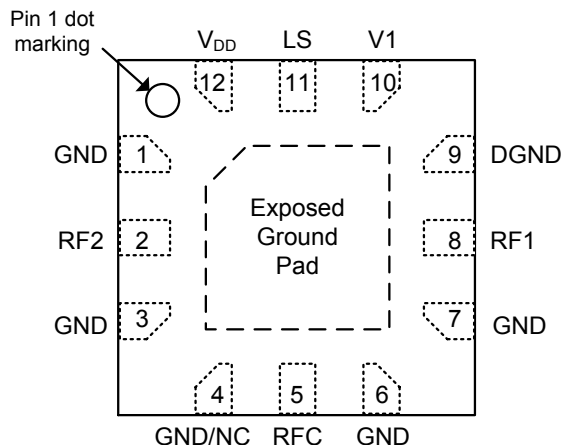

Table 3. Pin Descriptions

Pin No.	Pin Name	Description
1	GND	Ground
2	RF2 <sup>1</sup>	RF port 2
3	GND	Ground
4	GND/NC <sup>2</sup>	Ground or no connect
5	RFC <sup>1</sup>	RF common
6	GND	Ground
7	GND	Ground
8	RF1 <sup>1</sup>	RF port 1
9	DGND	Digital Ground
10	V1	Switch control input, CMOS logic level
11	LS	Logic Select, CMOS logic level
12	V <sub>DD</sub>	Supply
Pad	GND	Exposed pad: ground for proper operation

Notes: 1. RF pins 2, 5 and 8 must be at 0 VDC. The RF pins do not required DC blocking capacitors for proper operation if the 0 VDC requirement is met.  
2. Pin 4 can be grounded or left unconnected externally.

Table 4. Truth Table

Path	V1	LS
RFC-RF2	1	1
RFC-RF1	0	1
RFC-RF1	1	0
RFC-RF2	0	0

Table 5. Operating Ranges

Parameter	Min	Typ	Max	Unit
V <sub>DD</sub> Supply voltage	2.3	3.3	5.5	V
I <sub>DD</sub> Power supply current		180	300	μA
RFX-RFC input power			Fig. 4	dBm
Control voltage high	1.2	1.5	3.3	V
Control voltage low	0	0	0.5	V
Operating temperature range	-40	+25	+95	°C

Table 6. Absolute Maximum Ratings

Parameter/Condition	Min	Max	Unit
RF input power, 50Ω <sup>1</sup> 5-100 MHz 100-6000 MHz		33 34	dBm dBm
ESD voltage HBM <sup>2</sup> RF pins to GND All other pins		4000 1000	V V
ESD voltage MM, all pins <sup>3</sup>		200	V
T <sub>ST</sub> Storage temperature	-65	+150	°C

Notes: 1. V<sub>DD</sub> within operating range specified in Table 5.  
2. Human Body Model (MIL-STD 883 Method 3015.7).  
3. Machine Model (JEDEC JESD22-A115-A).

Exceeding absolute maximum ratings may cause permanent damage. Operation should be restricted to the limits in the *Operating Ranges* table.

### Electrostatic Discharge (ESD) Precautions

When handling this UltraCMOS device, observe the same precautions that you would use with other ESD-sensitive devices. Although this device contains circuitry to protect it from damage due to ESD, precautions should be taken to avoid exceeding the specified rating.

### Latch-Up Avoidance

Unlike conventional CMOS devices, UltraCMOS devices are immune to latch-up.

### Moisture Sensitivity Level

The Moisture Sensitivity Level rating for the PE42427 in the 12-lead 2 × 2 × 0.55 mm QFN package is MSL1.

Figure 4. Power De-rating Curve for 5-6000 MHz

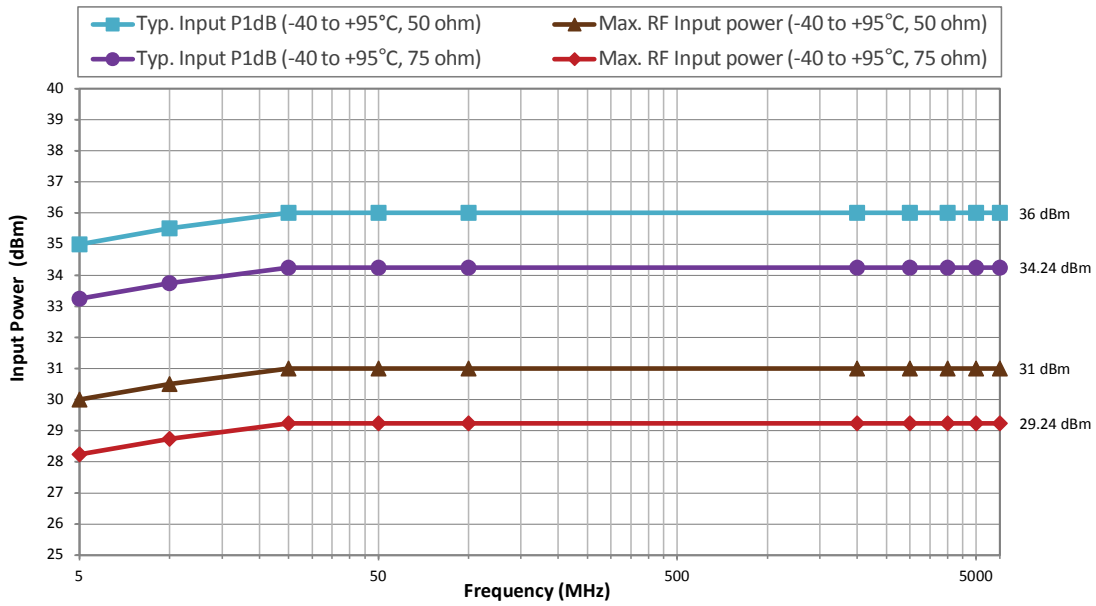

**Typical Performance Data @ +25 °C and  $V_{DD} = 3.3V$ , unless otherwise specified**

**Figure 5. Insertion Loss RFX\***

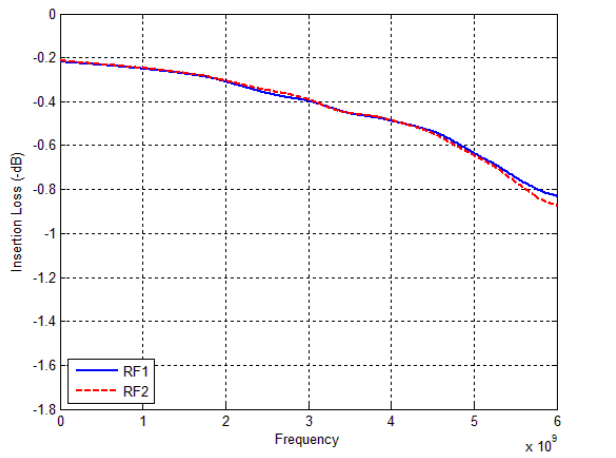

**Figure 6. Insertion Loss vs Temp (RF1-RFC)\***

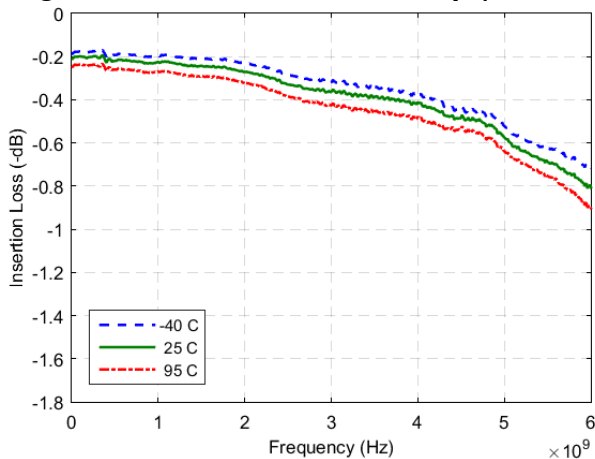

**Figure 8. Insertion Loss vs  $V_{DD}$  (RF1-RFC)\***

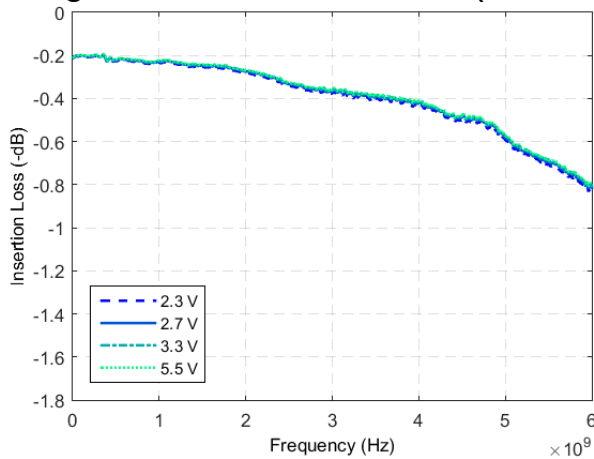

**Figure 7. Insertion Loss vs Temp (RF2-RFC)\***

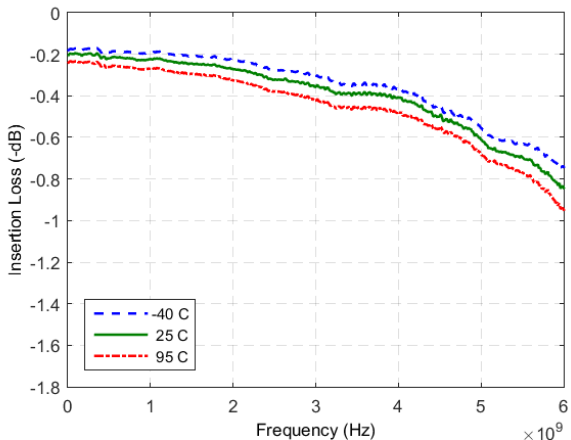

**Figure 9. Insertion Loss vs  $V_{DD}$  (RF2-RFC)\***

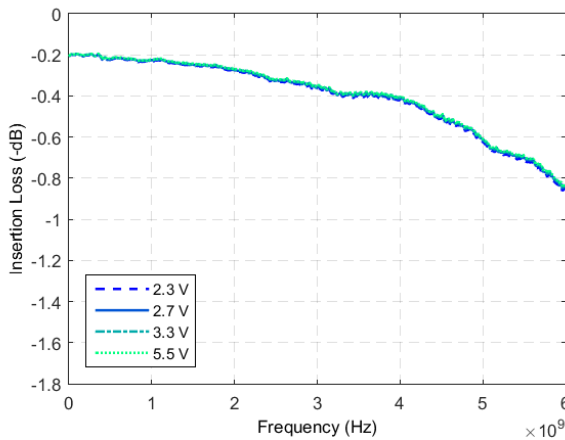

Note: \* High frequency performance can be improved by external matching (see Figure 22 through Figure 27 and Figure 30).

Typical Performance Data @ +25 °C and  $V_{DD} = 3.3V$ , unless otherwise specified (cont.)

Figure 10. RFX-RFX Isolation vs Temp

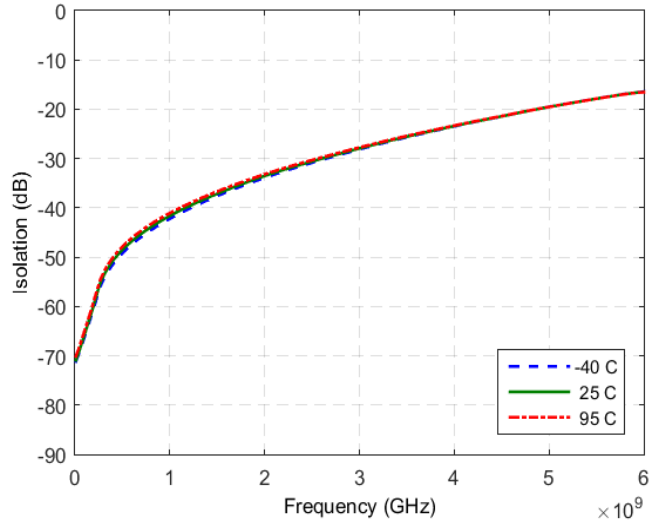

Figure 12. RFX-RFX Isolation vs  $V_{DD}$

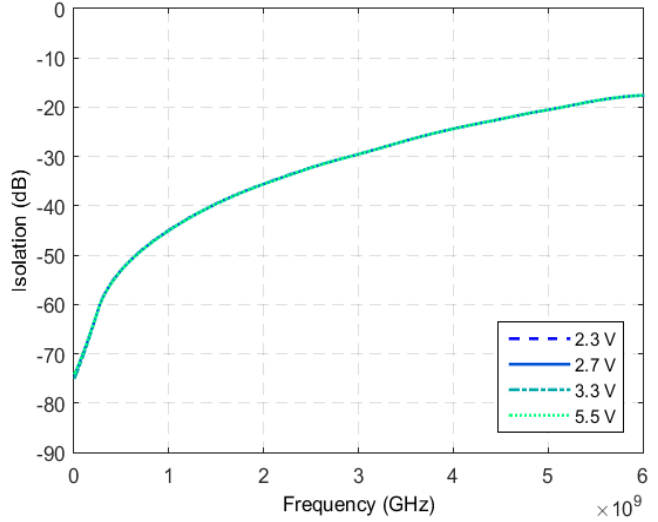

Figure 11. RFC-RFX Isolation vs Temp

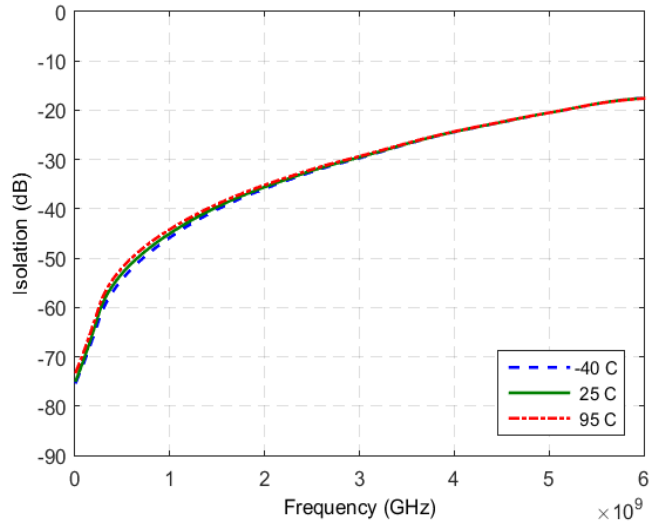
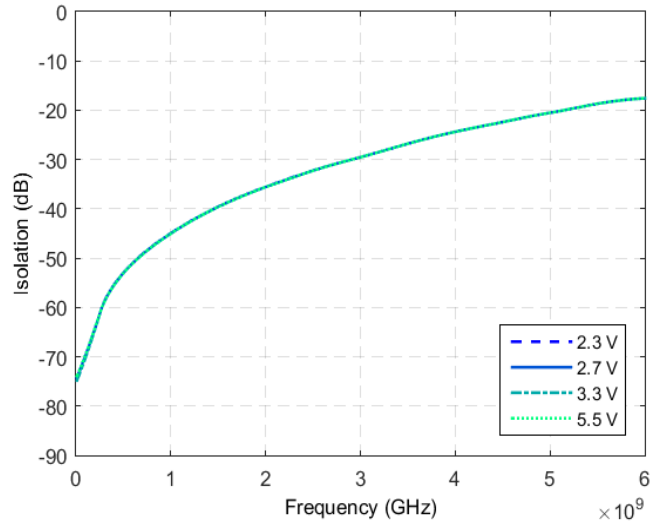
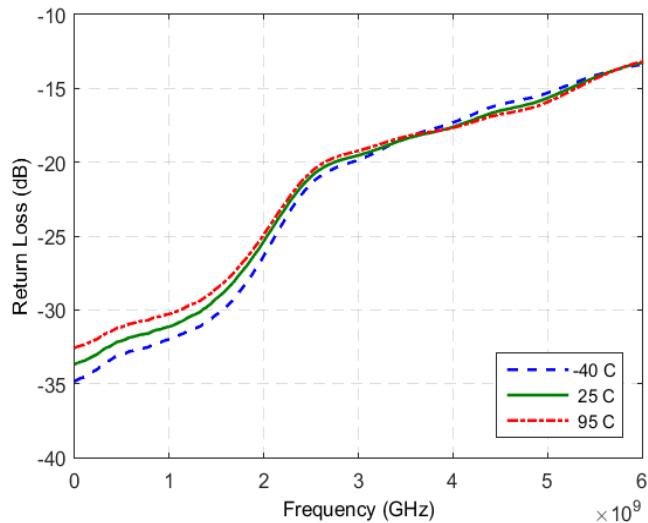

Figure 13. RFC-RFX Isolation vs  $V_{DD}$



**Typical Performance Data @ +25 °C and V<sub>DD</sub> = 3.3V, unless otherwise specified (cont.)**

**Figure 14. RFC Port Return Loss vs Temp (RF1 Active)\***



**Figure 16. RFC Port Return Loss vs V<sub>DD</sub> (RF1 Active)\***

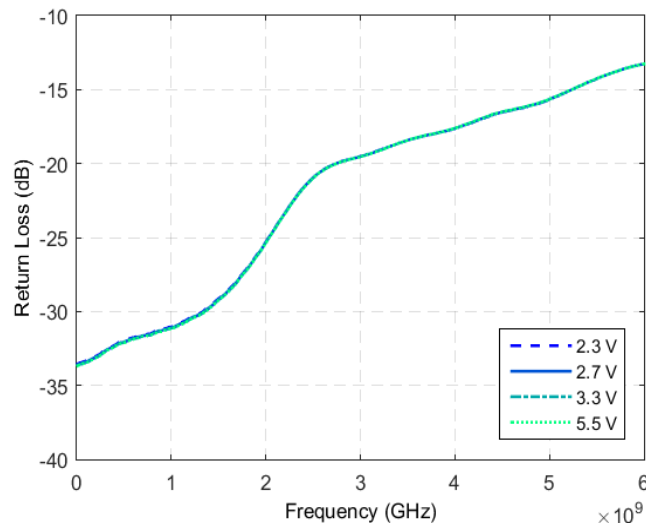

**Figure 15. RFC Port Return Loss vs Temp (RF2 Active)\***

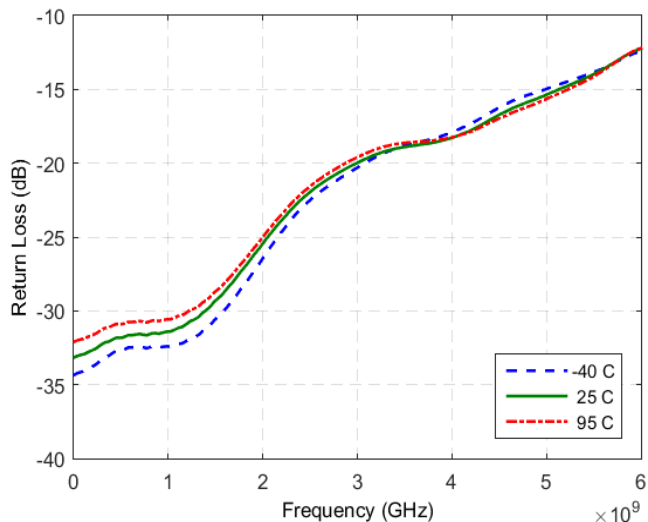

**Figure 17. RFC Port Return Loss vs V<sub>DD</sub> (RF2 Active)\***

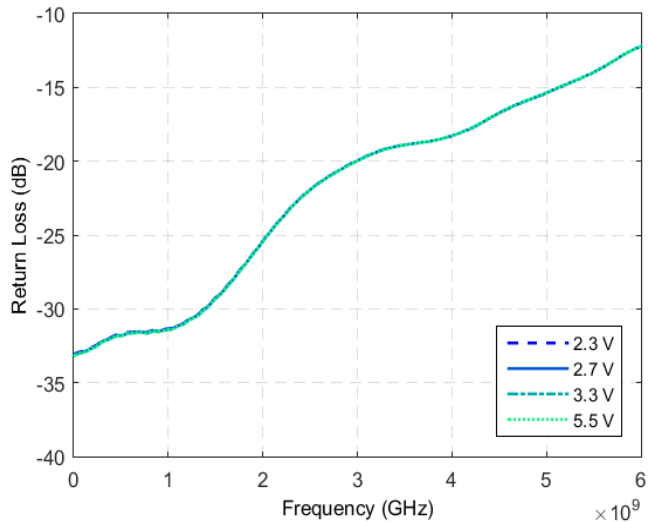

Note: \* High frequency performance can be improved by external matching (see Figure 22 through Figure 27 and Figure 30).



Typical Performance Data @ +25 °C and V<sub>DD</sub> = 3.3V, unless otherwise specified (cont.)

Figure 18. Active Port Return Loss vs Temp (RF1 Active)\*

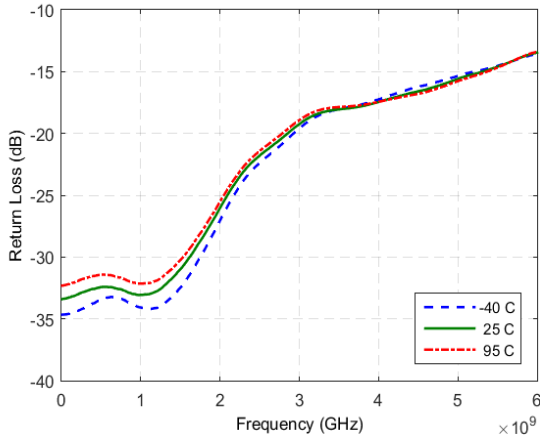

Figure 20. Active Port Return Loss vs V<sub>DD</sub> (RF1 Active)\*

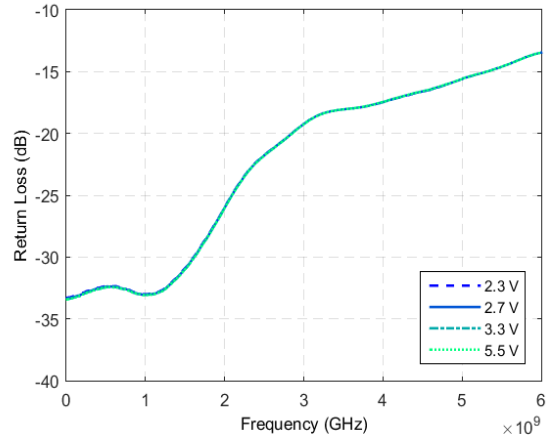

Figure 19. Active Port Return Loss vs Temp (RF2 Active)\*

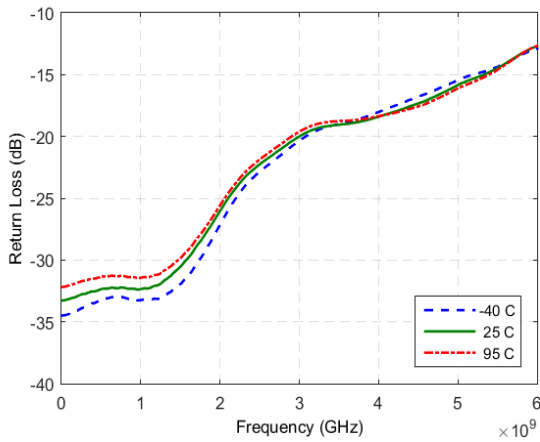
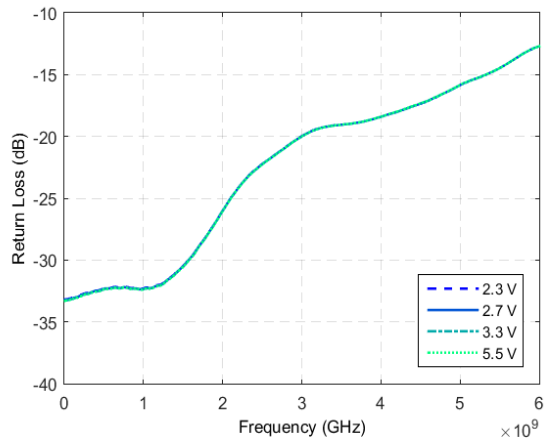

Figure 21. Active Port Return Loss vs V<sub>DD</sub> (RF2 Active)\*



Note: \* High frequency performance can be improved by external matching (see Figure 22 through Figure 27 and Figure 30).

**Performance Comparison @ +25 °C and  $V_{DD} = 3.3V$ , with or without matching**

**Figure 22. Insertion Loss RF1\***

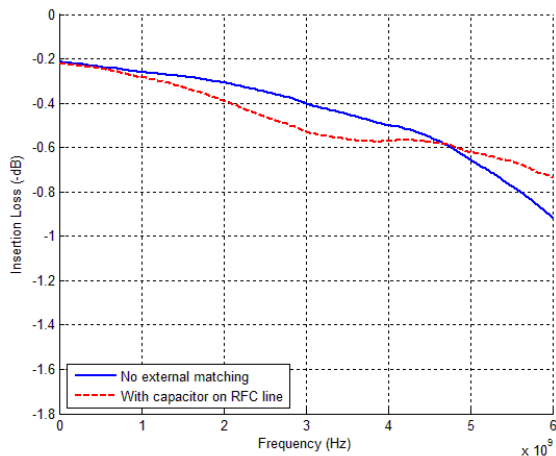

**Figure 25. Insertion Loss RF2\***

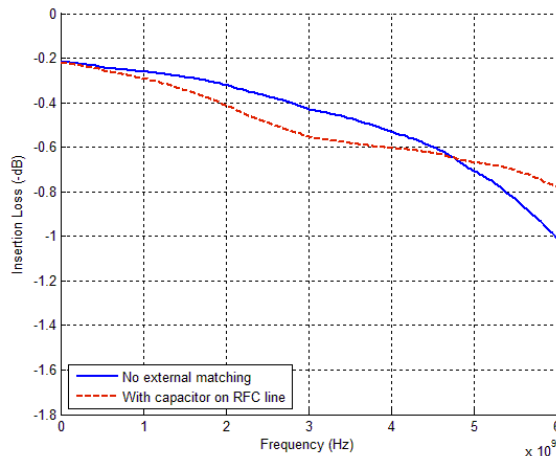

**Figure 23. Active Port Return Loss (RF1 Active)\***

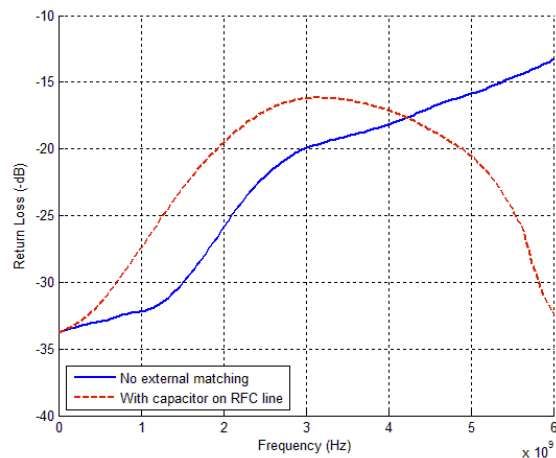

**Figure 26. Active Port Return Loss (RF2 Active)\***

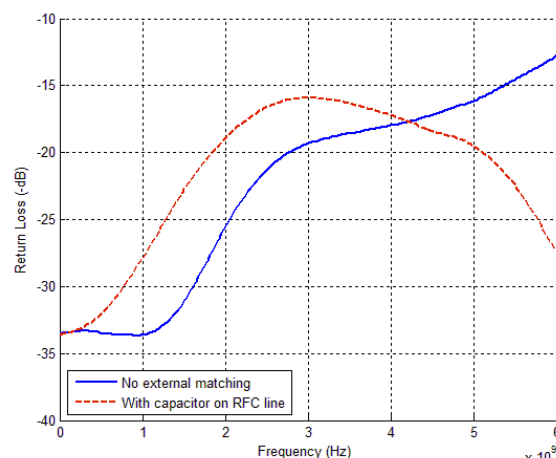

**Figure 24. RFC Port Return Loss (RF1 Active)\***

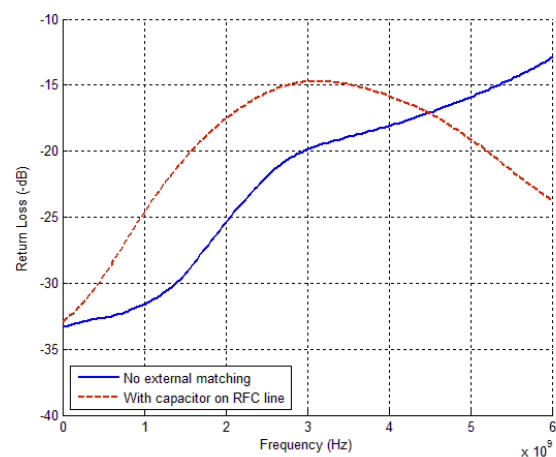

**Figure 27. RFC Port Return Loss (RF2 Active)\***

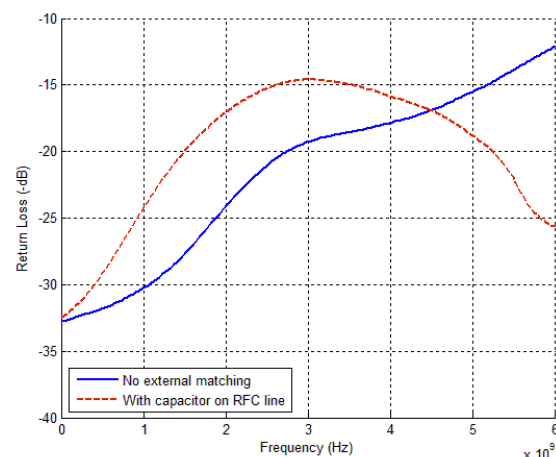

Note: \* High frequency performance can be improved by external matching (see Figure 22 through Figure 27 and Figure 30).

**Evaluation Board**

The SPDT switch evaluation board was designed to ease customer evaluation of pSemi’s PE42427. The RF common port is connected through a 50Ω transmission line via the top SMA connector, J2. RF1 and RF2 ports are connected through 50Ω transmission lines via SMA connectors J1 and J3, respectively. A through 50Ω transmission is available via SMA connectors J4 and J5. This transmission line can be used to estimate the loss of the PCB over the environmental conditions being evaluated. J8 provides DC and digital inputs to the device.

The board is constructed of a four metal layer material with a total thickness of 62 mils. The top and bottom RF layers are Rogers RO4350 material with a 10 mil RF core. The middle layers provide ground for the transmission lines. The transmission lines were designed using a coplanar waveguide with ground plane model using a trace width of 22 mils, trace gaps of 7 mils, and metal thickness of 2.1 mils.

**Figure 28. Evaluation Board Layout**

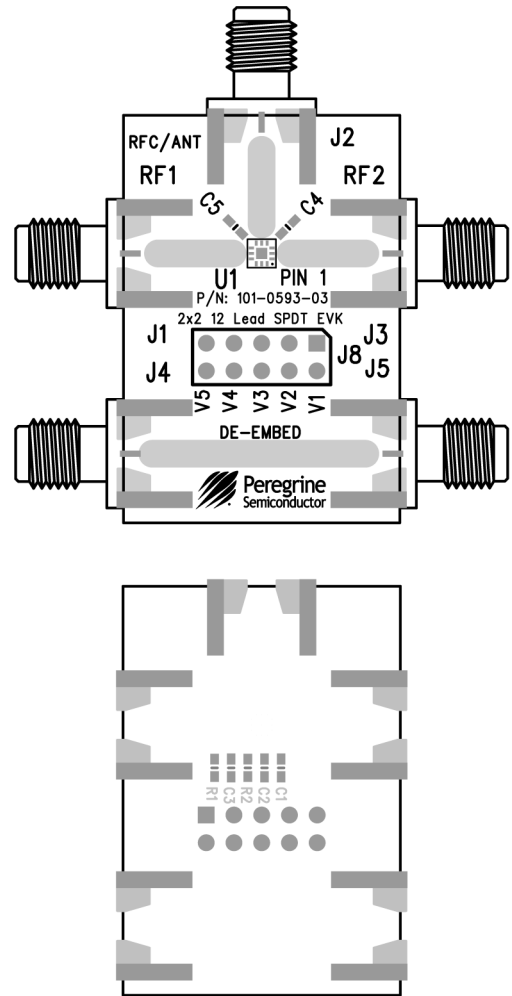

PRT-29005

**Figure 29. Evaluation Board Schematic**

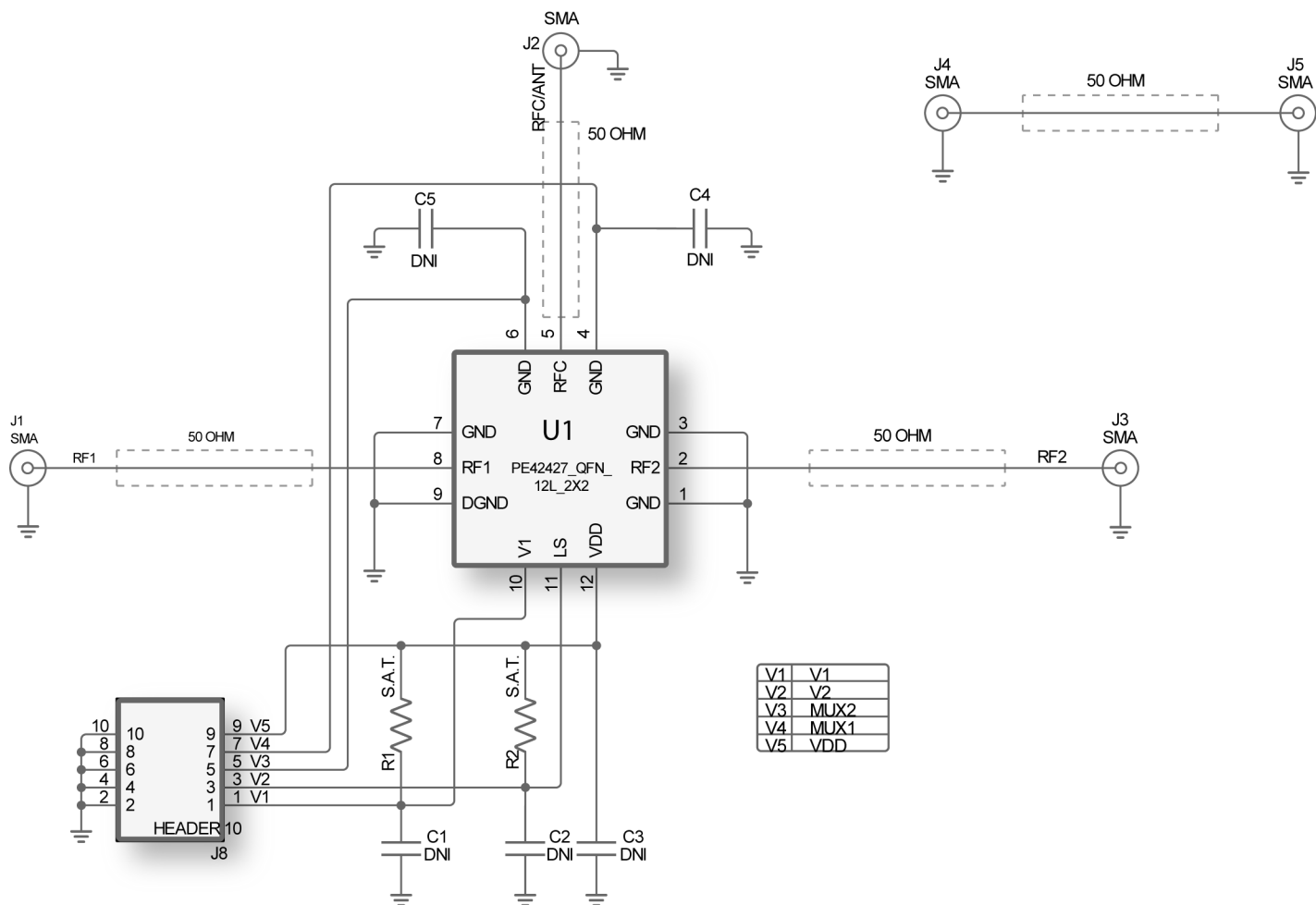
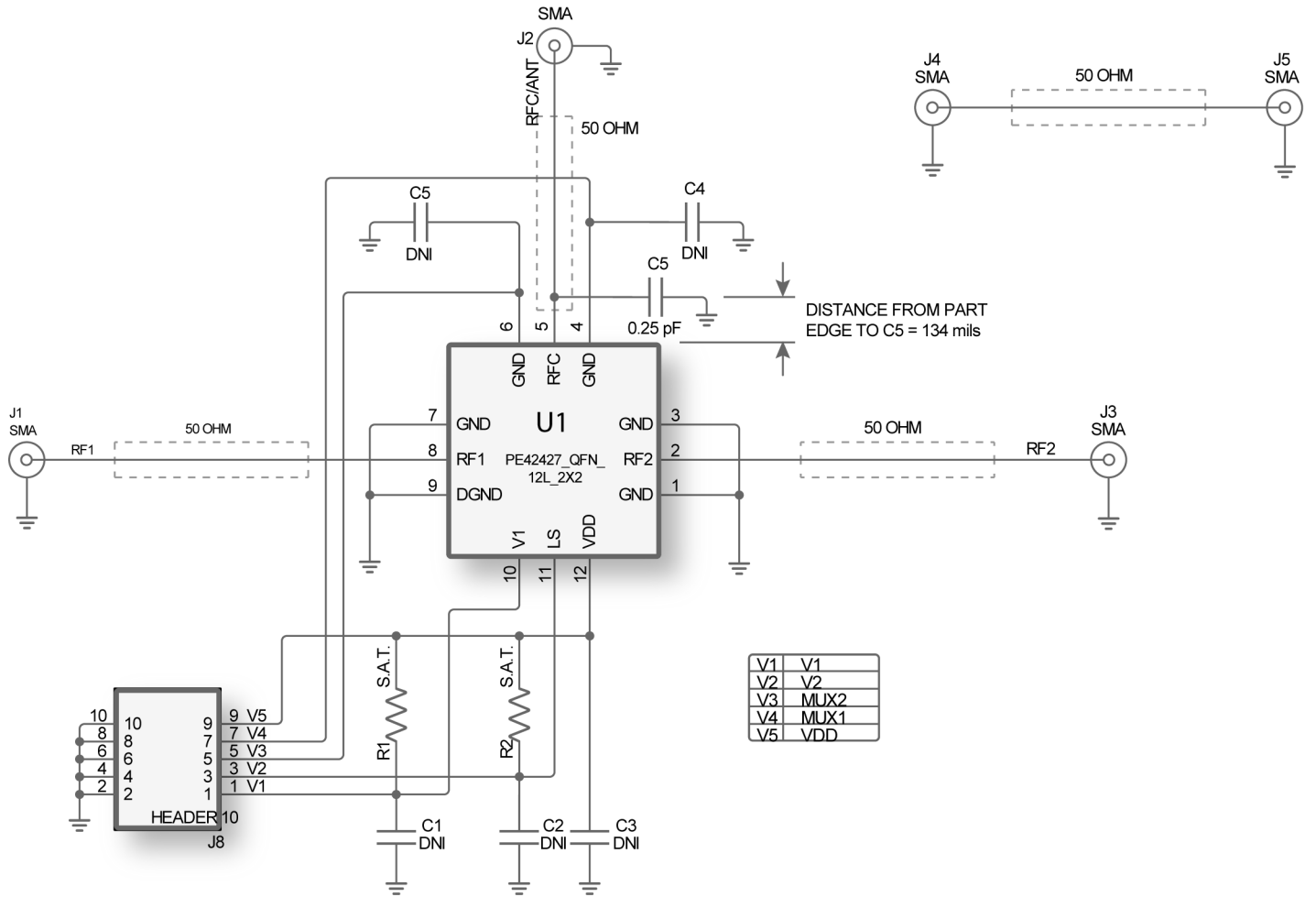
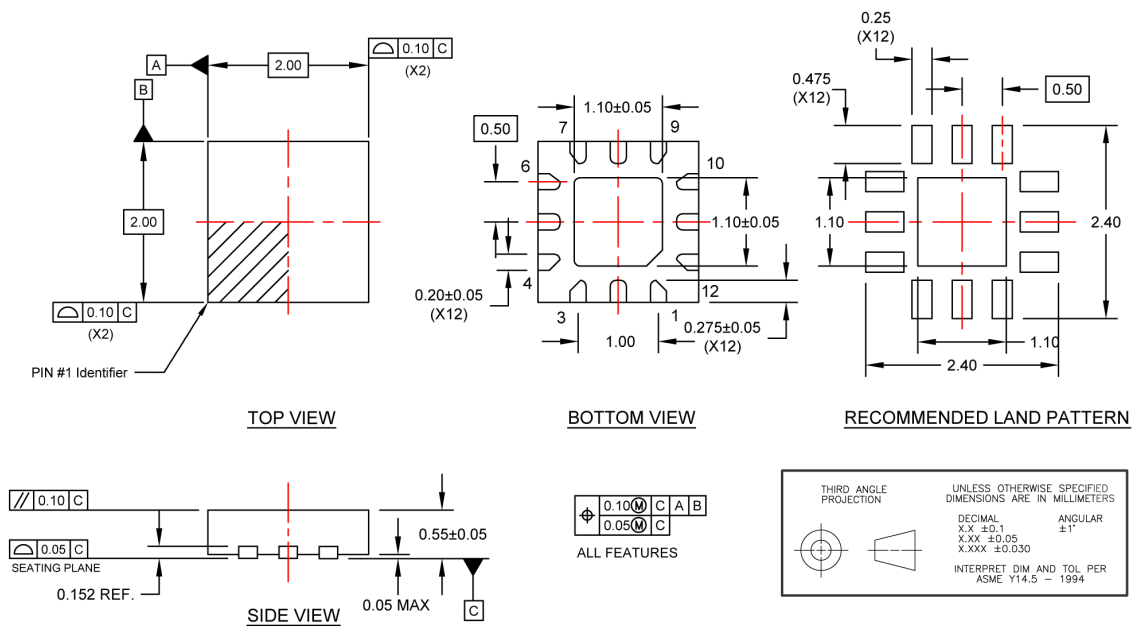

Figure 30. Evaluation Board Schematic with Matching

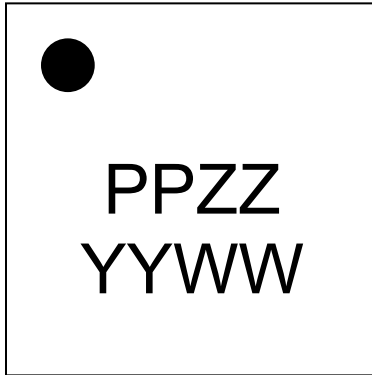

**Figure 31. Package Drawing**  
12-lead 2 × 2 × 0.55 mm QFN



12L\_2x2x0-55\_QFN\_DOC-01882-3

Figure 32. Top Marking Specifications



DOC-66046

Marking Spec Symbol	Package Marking	Definition
PP	EL	Part number marking for PE42427
ZZ	00-99	Last two digits of lot code
YY	00-99	Last two digits of assembly year (Ex: 15 for 2015)
WW	01-53	Work week

**Figure 33. Tape and Reel Specifications**  
12-lead 2 × 2 × 0.55 mm QFN

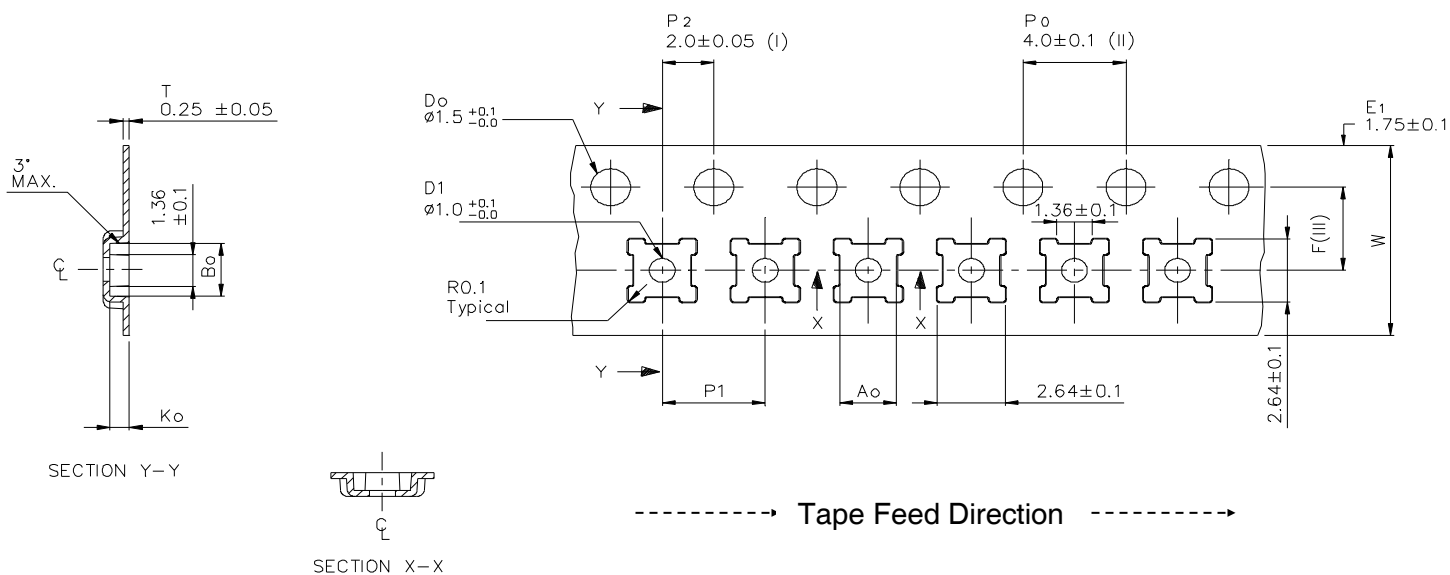

	Nominal	Tolerance
<b>Ao</b>	2.20	±0.1
<b>Bo</b>	2.20	±0.1
<b>Ko</b>	0.75	±0.1
<b>F</b>	3.50	±0.05
<b>P1</b>	4.00	±0.1
<b>W</b>	8.00	±0.3

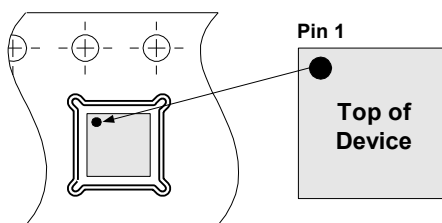

Device Orientation in Tape

- (I) Measured from centreline of sprocket hole to centreline of pocket.
- (II) Cumulative tolerance of 10 sprocket holes is ± 0.10 .
- (III) Measured from centreline of sprocket hole to centreline of pocket.
- (IV) Other material available.

This part shall not contain any banned substance as Sony standard SS-00259

**Table 6. Ordering Information**

Order Code	Description	Package	Shipping Method
PE42427A-Z	PE42427 SPDT RF switch	Green 12-lead 2 × 2mm QFN	3000 units T/R
EK42427-01	PE42427 Evaluation board	Evaluation kit	1/Box

**Sales Contact and Information**

For sales and contact information please visit [www.psemi.com](http://www.psemi.com).

**Advance Information:** The product is in a formative or design stage. The datasheet contains design target specifications for product development. Specifications and features may change in any manner without notice.  
**Preliminary Specification:** The datasheet contains preliminary data. Additional data may be added at a later date. pSemi reserves the right to change specifications at any time without notice in order to supply the best possible product.  
**Product Specification:** The datasheet contains final data. In the event pSemi decides to change the specifications, pSemi will notify customers of the intended changes by issuing a CNF (Customer Notification Form).  
 The information in this document is believed to be reliable. However, pSemi assumes no liability for the use of this information. Use shall be entirely at the user's own risk. No patent rights or licenses to any circuits

described in this document are implied or granted to any third party. pSemi's products are not designed or intended for use in devices or systems intended for surgical implant, or in other applications intended to support or sustain life, or in any application in which the failure of the pSemi product could create a situation in which personal injury or death might occur. pSemi assumes no liability for damages, including consequential or incidental damages, arising out of the use of its products in such applications.  
 The Peregrine Semiconductor name, Peregrine Semiconductor logo and UltraCMOS are registered trademarks and the pSemi name, pSemi logo, HaRP and DuNE are trademarks of pSemi Corporation in the U.S. and other countries.  
 pSemi products are protected under one or more of the following U.S. Patents: <http://patents.psemi.com>.



## X-ON Electronics

Largest Supplier of Electrical and Electronic Components

*Click to view similar products for [Gate Drivers](#) category:*

*Click to view products by [pSemi](#) manufacturer:*

Other Similar products are found below :

[00028](#) [00053P0231](#) [8967380000](#) [56956](#) [CR7E-30DB-3.96E\(72\)](#) [57.404.7355.5](#) [LT4936](#) [57.904.0755.0](#) [5801-0903](#) [5803-0901](#) [5811-0902](#)  
[5813-0901](#) [58410](#) [00576P0030](#) [00581P0070](#) [5882900001](#) [00103P0020](#) [00600P0005](#) [00-9050-LRPP](#) [00-9090-RDPP](#) [5951900000](#) [01-](#)  
[1003W-10/32-15](#) [LTI LA6E-1S-WH-RC-FN12VXCR1](#) [0131700000](#) [00-2240](#) [LTP70N06](#) [LVP640](#) [0158-624-00](#) [5J0-1000LG-SIL](#) [020017-13](#)  
[LY1D-2-5S-AC120](#) [LY2-0-US-AC120](#) [LY2-US-AC240](#) [LY3-UA-DC24](#) [00-5150](#) [00576P0020](#) [00600P0010](#) [LZNQ2M-US-DC5](#) [LZNQ2-](#)  
[US-DC12](#) [LZP40N10](#) [00-8196-RDPP](#) [00-8274-RDPP](#) [00-8275-RDNP](#) [00-8609-RDPP](#) [00-8722-RDPP](#) [00-8728-WHPP](#) [00-8869-RDPP](#) [00-](#)  
[9051-RDPP](#) [00-9091-LRPP](#) [00-9291-RDPP](#)